neurochirurgie
neurosurgery
neurocirugía
neurochirurgie
neurochirurgia

nopa[®] instruments



nopa[®]







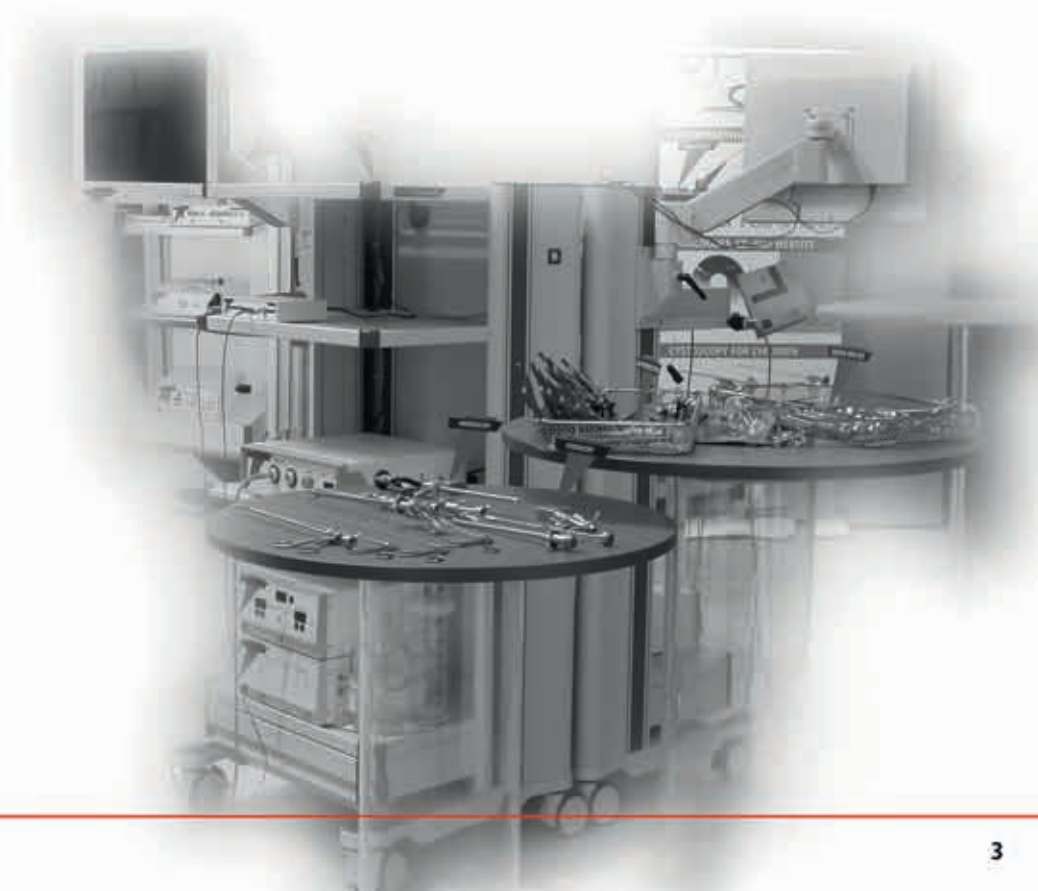

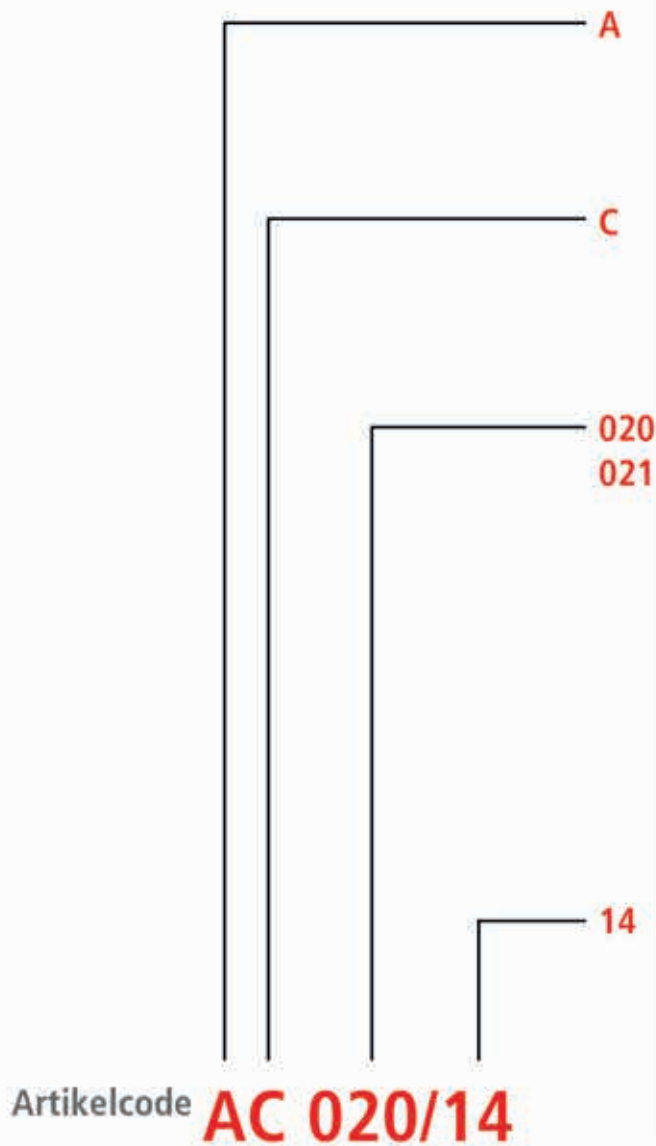
**Allgemeines Instrumentarium**

General Instruments
 Instrumental Général
 Instruments Générales
 Strumenti generali

Scheren

Scissors
 Tijeras
 Ciseaux
 Forbici

Fortlaufende Nummern

Gerade Ziffer = gerades Instrument
 Ungerade Ziffer = gebogenes Instrument

Continuous number

Even number = straight instrument
 Odd number = curved instrument

Número de orden

números pares = instrumento derecho
 números impares = instrumento curvado

Numéros d'ordre

numéro pair = instrument droit
 numéro impair = instrument courbe

Numeri progressivamente

numero pari = strumento retto
 numero dispari = strumento curvo

Länge oder Figur

Length or Figure
 Longitud o figura
 Longueur ou figure
 Lunghezza o figura

INDEX

>> Klemmen >> Hemostats >> Pinzas hemostáticas >> Pincas hémostatiques >> Pinze emostatiche	7–10	AA
>> Pinzetten >> Forceps >> Pinzas >> Pincas >> Pinze	11–20	AB
>> Scheren >> Scissors >> Tijeras >> Ciseaux >> Forbici	21–34	AC
>> Naht >> Suture >> Sutura >> Suture >> Sutura	35–42	AE
>> Wundhaken >> Retractors >> Separadores >> Ecarteurs >> Divaricatori	43–54	AK
>> Punktion/Kanülen >> Puncture/Special Needles >> Punción/Agujas especiales >> Punction/Aiguilles spéciales >> Puntura/Aghi speciali	55–56	AO
>> Diagnostik >> Diagnostics >> Diagnóstico >> Diagnostic >> Diagnostica	57–60	AR
>> Orthopädie >> Orhtopaedics >> Ortopedia >> Orthopédie >> Ortopedia	61–82	KA
>> Neurochirurgie >> Neurosurgery >> Neurocirurgia >> Neurochirurgie >> Neurochirurgia	83–168	KS
>> Endoskopie >> Endoscopy >> Endoscopia >> Endoscopie >> Endoscopia	169–172	XR
>> Endoskopie >> Endoscopy >> Endoscopia >> Endoscopie >> Endoscopia	173–178	XT

>> Unser Lieferprogramm · Instrumente für die Allgemeinchirurgie
 Instrumente für die spezielle Chirurgie
 Instrumente für die Mikrochirurgie
 Instrumente für die Arztpraxis
 Instrumente für den Dentalbereich
 Instrumente für die Veterinärmedizin

Endoskopische Geräte und Instrumente

Behältnisse zur Instrumentensterilisation
 Skalpellklingen und Skalpellgriffe

>> Nuestro programa de fabricación

Instrumentos para la cirugía general
 Instrumentos para la cirugía especial
 Instrumentos para la micro-cirugía
 Instrumentos para la consulta
 Instrumentos dentales
 Instrumentos veterinarios

Equipo endoscópico e instrumentos

Cajas para esterilización
 Hojas de bisturios y mangos

>> Nostro programma di produzione

Strumenti per la chirurgia generale
 Strumenti per la chirurgia speciale
 Strumenti per la micro-chirurgia
 Strumenti per ambulatorio
 Strumenti per odontoiatrica
 Strumenti per veterinaria

Strumenti ed accessorio per l'endoscopia

Astucci per la sterilizzazione
 Bisturi e manici per bisturi

>> Our product range

Instruments for General Surgery
 Instruments for Special Surgery
 Instruments for Micro Surgery
 Instruments for the General Practitioner
 Instruments for Dental Practice and Surgery
 Instruments for Veterinary Surgery

Endoscopic equipment and instruments

Instruments Sterilizing Containers
 Scalpel Blades and Scalpel Handles

>> Notre gamme

Des instruments pour la chirurgie générale
 Des instruments pour la chirurgie spéciale
 Des instruments pour la micro-chirurgie
 Des instruments pour les praticiens
 Des instruments pour le ressort dentaire
 Des instruments pour les vétérinaires

Equipement et instruments pour l'endoscopie

Des boîtes à instruments et pour la stérilisation
 Des lames et des manches de bistouri



KLEMMEN
HEMOSTATS
PINZAS HEMOSTATICAS
PINCES HEMOSTATIQUES
PINZE EMOSTATICHE

AA

nopa[®] instruments



Kopfhautklemmen
 Scalp Flap Forceps
 Pinzas hemostáticas para pericráneo
 Pincès hémostatiques pour le cuir chevelu
 Pinze emostatiche per il cuoio capelluto

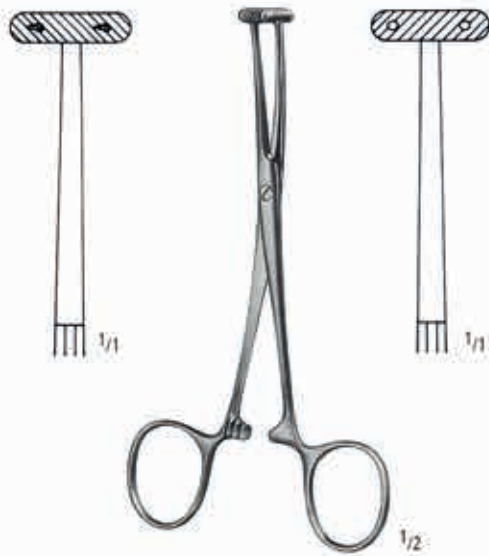

MARTEL
 AA 078/14
 14,0 cm/5 1/2"

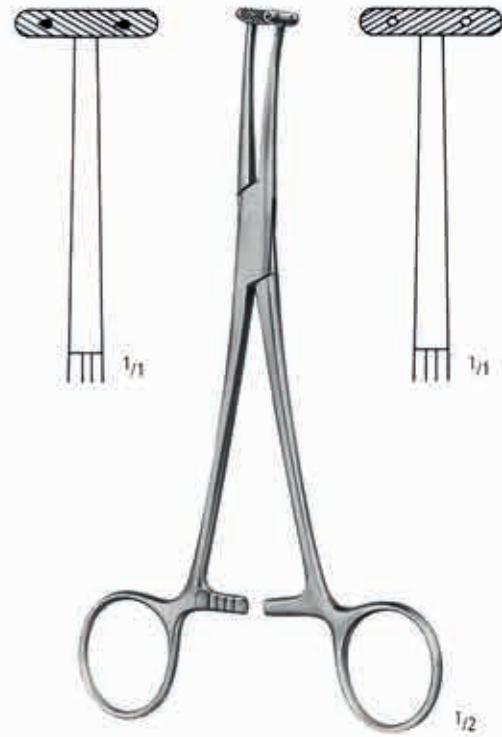

WILLET-MARTEL
 AA 078/19
 19,0 cm/7 1/2"

Feine Arterienklemmen
 Fine Artery Forceps
 Pinzas hemostáticas finas
 Pincas hémostatiques fines
 Pinze emostatiche fine

AA

AB

AC

AE

AK

AO

AB

KA

KS

XR

XT



MICRO-MOSQUITO

AA 130/10 AA 131/10
 AA 130/12 AA 131/12

10,0 cm/4"
 12,0 cm/4³/₄"

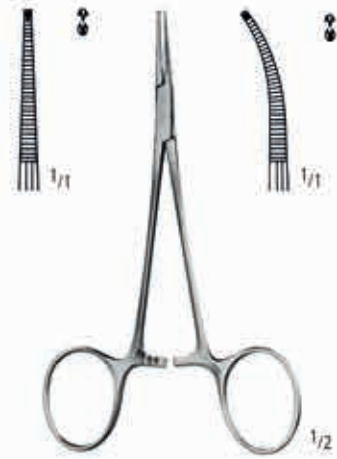

MICRO-MOSQUITO 1:2

AA 132/10 AA 133/10
 AA 132/12 AA 133/12



BABY-OVERHOLT

AA 225/13
 13,5 cm/5¹/₄"



BABY-ADSON

AA 235/14
 14,0 cm/5¹/₂"

Präparierklemmen
Dissecting Forceps
Pinzas para preparaciones
Pincès à dissection
Pinze per preparazione



DANDY
AA 291/14
14,0 cm/5 1/2"

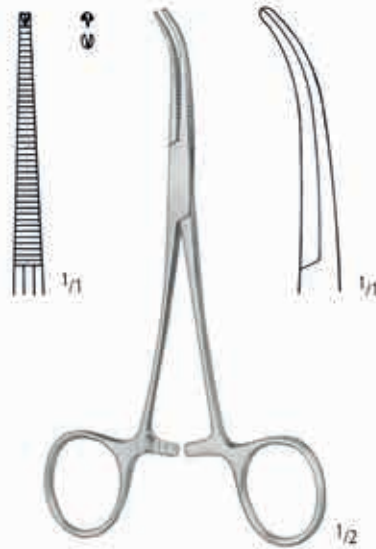

DANDY 1:2
AA 293/14
14,0 cm/5 1/2"

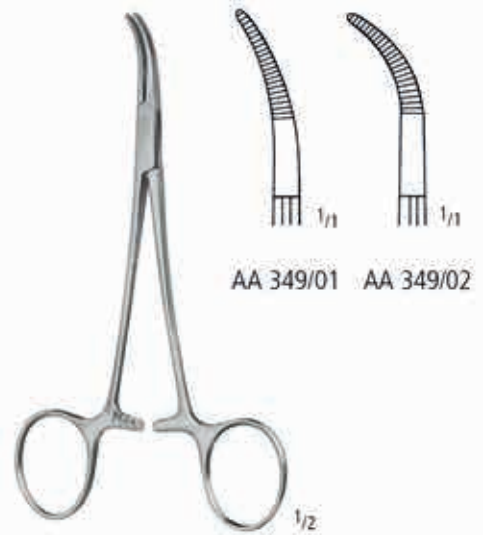

BABY-MIXER
14,0 cm/5 1/2"



GEMINI



AA 365/14
14,0 cm/5 1/2"



AA 365/18
18,0 cm/7"

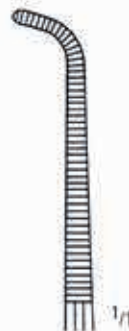

AA 365/22
22,0 cm/8 3/4"



AA 365/25
25,0 cm/10"

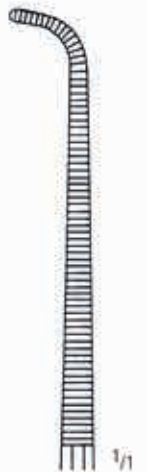

AA 365/28
28,0 cm/11"

Weitere Klemmen siehe Katalog A 7-51 und Gruppe KS.
For further hemostats see catalogue A 7-51 and section KS.
Para otras pinzas hemostáticas ver catálogo A 7-51 y sección KS.
D'autres pincès hémostatiques voir notre catalogue A 7-51 et groupe KS.
Per altre pinze emostatiche consultare il nostro catalogo A 7-51 e gruppo KS.

PINZETTEN
FORCEPS
PINZAS
PINCES
PINZE

AB

nopa[®] instruments



AB PINZETTEN FORCEPS PINZAS PINCES PINZE

Anatomische Pinzetten, Chirurgische Pinzetten
 Dressing Forceps, Tissue Forceps
 Pinzas de disección, Pinzas de disección con dientes
 Pincers à dissection, Pincers à griffes
 Pinze anatomiche per dissezione, Pinze chirurgiche a denti di topo



AB 100/12

1/2



AB 102/12

1/2



AB 110/12

1/2



AB 112/12

1/2

12,0 cm/4³/₄"
 15,0 cm/6"

ADSON
 AB 100/12
 AB 100/15

MICRO-ADSON
 AB 102/12
 AB 102/15

ADSON 1:2
 AB 110/12
 AB 110/15

MICRO-ADSON 1:2
 AB 112/12
 AB 112/15



7:7
 AB 116/07

1/11

9:9
 AB 116/09

1/2

ADSON-BROWN

12,0 cm/4³/₄"



9:9

1/2

ADSON-BROWN

AB 117/09
 12,0 cm/4³/₄"

PINZETTEN FORCEPS PINZAS PINCES PINZE

Anatomische Pinzetten, Chirurgische Pinzetten
 Dressing Forceps, Tissue Forceps
 Pinzas de disección, Pinzas de disección con dientes
 Pincés à dissection, Pincés à griffes
 Pinze anatomiche per dissezione, Pinze chirurgiche a denti di topo

AA

AB

AC

AE

AK

AO

AR

KA

KS

XR

XT



CUSHING
AB 180/17

17,5 cm/7"



CUSHING
AB 181/17



CUSHING 1:2
AB 190/17

17,5 cm/7"



CUSHING 1:2
AB 191/17

AB PINZETTEN FORCEPS PINZAS PINCES PINZE

Uhrmacherpinzetten
 Jeweler's Forceps
 Pinzas de relojero
 Pincès d'horloger
 Pinze da orologiaio



No. 1 AB 501/01
 12,0 cm/4³/₄"



No. 2 AB 501/02
 12,0 cm/4³/₄"



No. 3 AB 501/03
 12,0 cm/4³/₄"



No. 4 AB 501/04
 11,0 cm/4¹/₂"



No. 5 AB 501/05
 11,0 cm/4¹/₂"



No. 5a AB 501/15
 11,0 cm/4¹/₂"



No. 5/45° AB 501/45
 10,5 cm/4"



No. 5/90° AB 501/90
 10,5 cm/4"



No. 7 AB 502/07
 11,5 cm/4¹/₂"

PINZETTEN FORCEPS PINZAS PINCES PINZE

Fasspinzetten
Grasping Forceps
Pinzas para coger
Pincers pour saisir les tissus
Pinze per afferrare tessuti



AB 506/01
Ø 3,0 mm

AB 506/02
Ø 3,0 mm

SAMII
24,0 cm/9¹/₄"

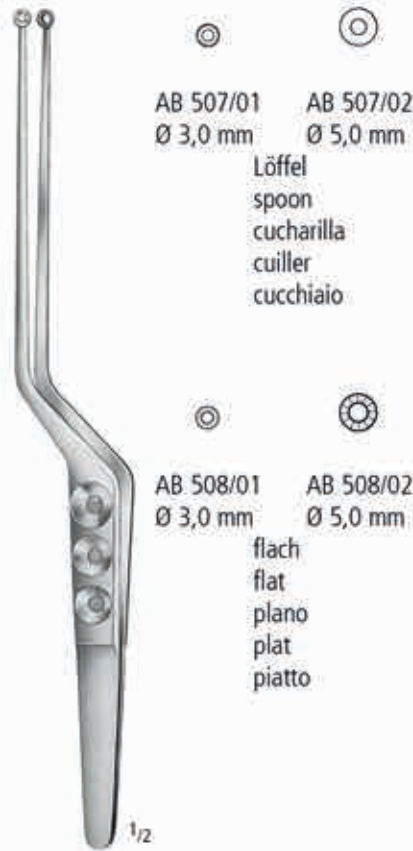

AB 507/01
Ø 3,0 mm

AB 507/02
Ø 5,0 mm

Löffel
spoon
cucharilla
cuiller
cucchiaio

AB 508/01
Ø 3,0 mm

AB 508/02
Ø 5,0 mm

flach
flat
plano
plat
piatto

22,0 cm/8³/₄"

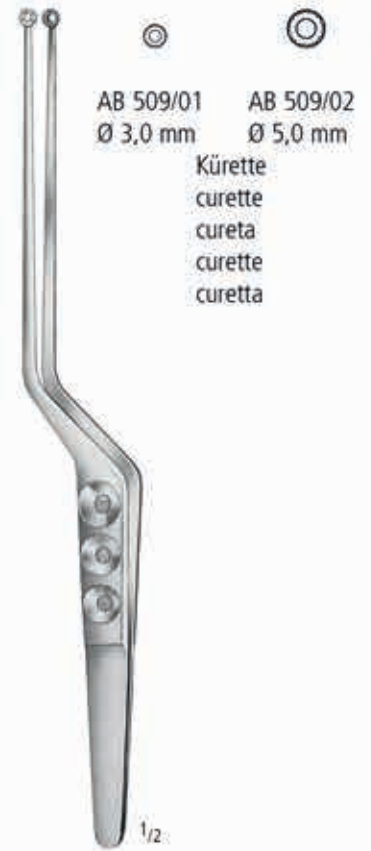

AB 509/01
Ø 3,0 mm

AB 509/02
Ø 5,0 mm

Kürette
curette
cureta
curette
curetta

HEIFETZ
22,0 cm/8³/₄"



HUNT
AB 510/20
20,0 cm/8"

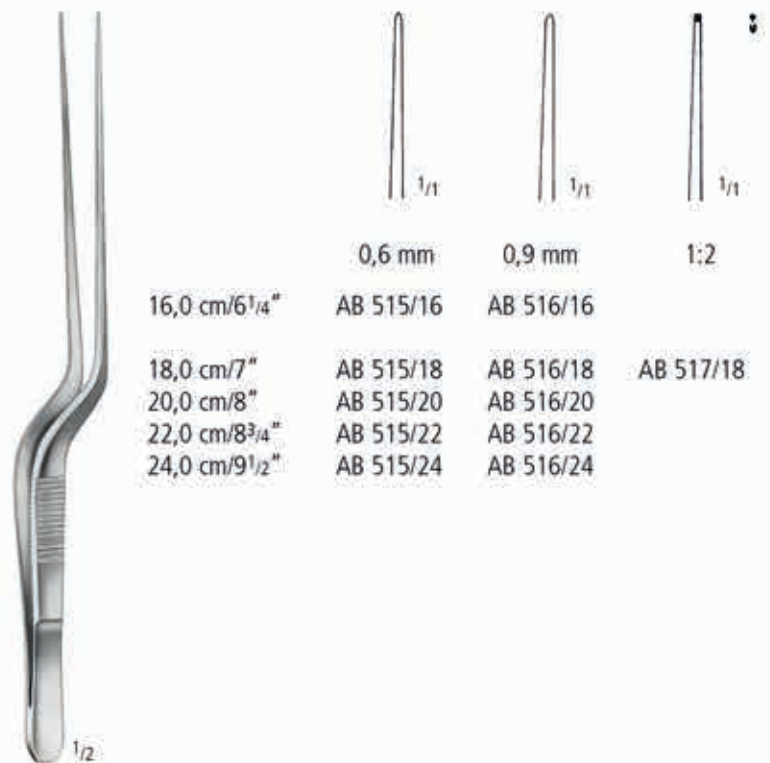

16,0 cm/6¹/₄"

18,0 cm/7"

20,0 cm/8"

22,0 cm/8³/₄"

24,0 cm/9¹/₂"

0,6 mm

0,9 mm

1:2

AB 515/16

AB 515/18

AB 515/20

AB 515/22

AB 515/24

AB 516/16

AB 516/18

AB 516/20

AB 516/22

AB 516/24

AB 517/18

AA
AB
AC
AE
AK
AO
AB
KA
KS
XR
XT

AB PINZETTEN FORCEPS PINZAS PINCES PINZE

Mikro-Pinzetten, Knüpfpinzetten mit Plateau
 Micro Forceps, Suture Tying Forceps with platform
 Micro-Pinzas, Pinzas de ligadura con plataforma
 Micro-Pinces, Pinces à ligature avec plate-forme
 Micro-Pinze, Pinze per ligature con piattaforma

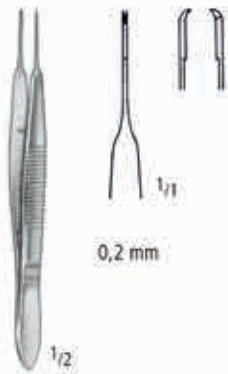

AB 530/09 1:2
 9,5 cm/3³/₄"



AUSTIN
AB 532/14
 14,0 cm/5¹/₂"



AUSTIN
AB 532/18
 18,0 cm/7"



AB 534/12
 12,0 cm/4³/₄"



WISE
AB 534/13
 13,5 cm/5¹/₄"



WISE
AB 535/13
 13,5 cm/5¹/₄"

PINZETTEN FORCEPS PINZAS PINCES PINZE

Mikro-Pinzetten, Knüpfpinzetten mit Plateau
 Micro Forceps, Suture Tying Forceps with platform
 Micro-Pinzas, Pinzas de ligadura con plataforma
 Micro-Pinces, Pinces à ligature avec plate-forme
 Micro-Pinze, Pinze per ligature con piattaforma

AA

AB

AC

AE

AK

AO

AB

KA

KS

XR

XT



AB 536/14
 14,0 cm/5 1/2"



AB 538/14 1:2
 14,0 cm/5 1/2"



AB 540/14 1:2
 14,0 cm/5 1/2"

AB PINZETTEN FORCEPS PINZAS PINCES PINZE

Mikro-Pinzetten
 Micro Forceps
 Micro-Pinzas
 Micro-Pinces
 Micro-Pinze



12,0 cm/4³/₄"
 15,0 cm/6"



0,3 mm

AB 542/12
 AB 542/15



0,3 mm

AB 543/12
 AB 543/15



18,0 cm/7"



AB 544/18



AB 545/18

Weitere Mikro-Pinzetten siehe Gruppe KS.
 For further micro forceps see section KS.
 Para otras micro-pinzas ver sección KS.
 D'autres micro-pinces voir groupe KS.
 Altre micro-pinze vedi gruppo KS.

PINZETTEN FORCEPS PINZAS PINCES PINZE

Atraumatische Pinzetten
 Non-traumatic Vascular Tissue Forceps
 Pinzas Atrauma
 Pincas Atrauma
 Pinze Atrauma

AA

AB

AC

AE

AK

AO

AB

KA

KS

XR

XT

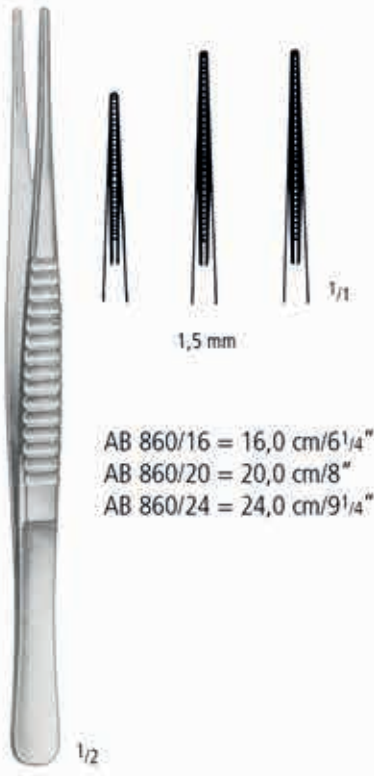

1,5 mm

- AB 860/16 = 16,0 cm/6 1/4"
- AB 860/20 = 20,0 cm/8"
- AB 860/24 = 24,0 cm/9 1/4"

1/2

DE BAKEY

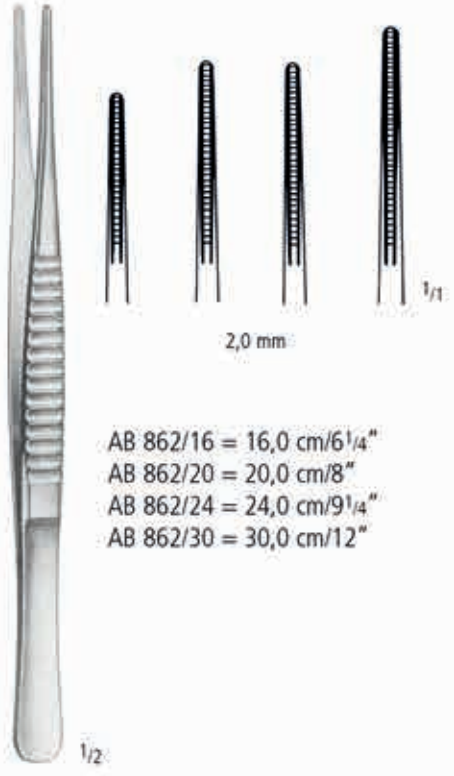

2,0 mm

- AB 862/16 = 16,0 cm/6 1/4"
- AB 862/20 = 20,0 cm/8"
- AB 862/24 = 24,0 cm/9 1/4"
- AB 862/30 = 30,0 cm/12"

1/2

DE BAKEY

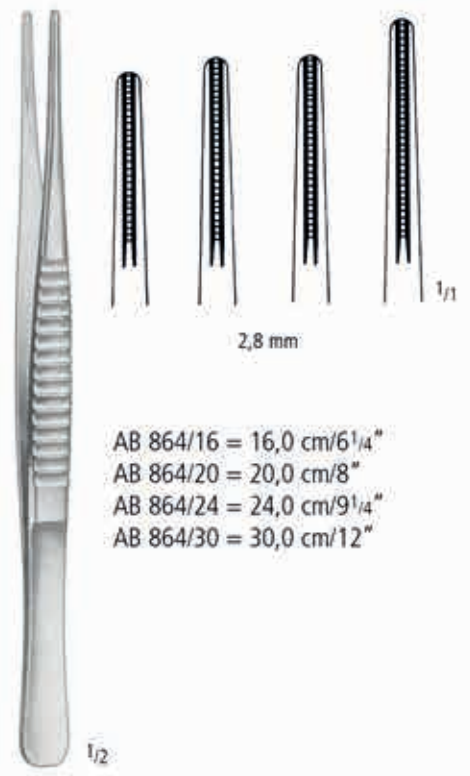

2,8 mm

- AB 864/16 = 16,0 cm/6 1/4"
- AB 864/20 = 20,0 cm/8"
- AB 864/24 = 24,0 cm/9 1/4"
- AB 864/30 = 30,0 cm/12"

1/2

DE BAKEY

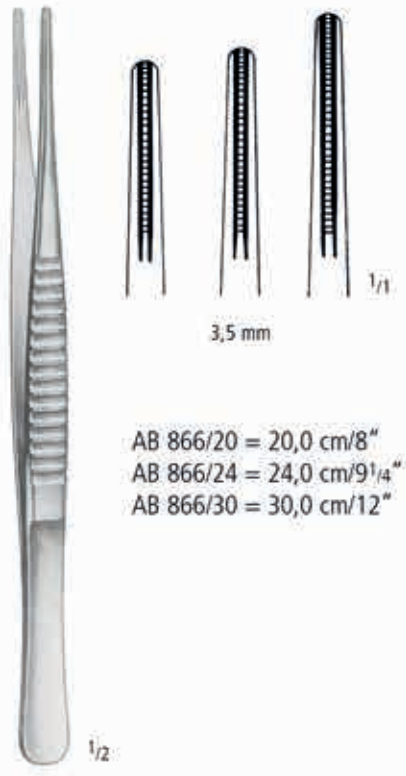

3,5 mm

- AB 866/20 = 20,0 cm/8"
- AB 866/24 = 24,0 cm/9 1/4"
- AB 866/30 = 30,0 cm/12"

1/2

DE BAKEY

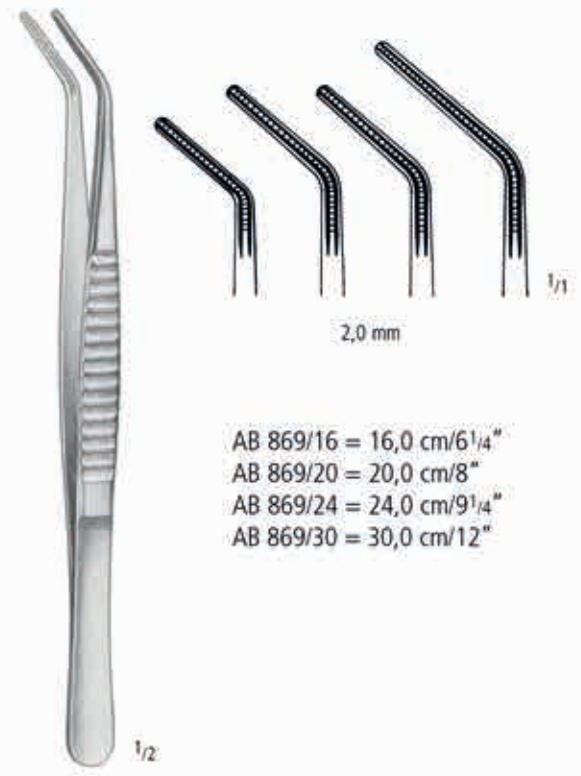

2,0 mm

- AB 869/16 = 16,0 cm/6 1/4"
- AB 869/20 = 20,0 cm/8"
- AB 869/24 = 24,0 cm/9 1/4"
- AB 869/30 = 30,0 cm/12"

1/2

DE BAKEY

Pinzetten mit Hartmetalleinsätzen
 Dissecting Forceps with Tungsten Carbide Inserts
 Pinzas de disección con bocas de carburo de tungsteno
 Pincès à dissection avec mors en carbure de tungstène
 Pinze per dissezione con punte di carburo di tungsteno

nopa[®]
TUC

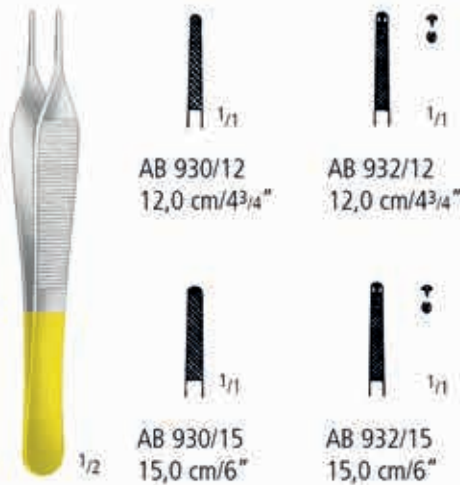

ADSON

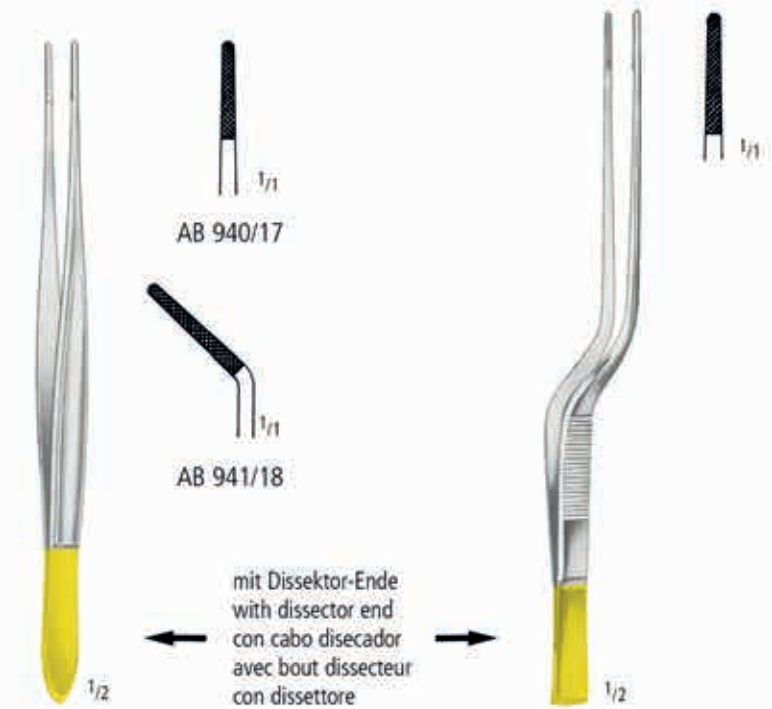

CUSHING
17,5 cm/7"

CUSHING-TAYLOR
AB 943/18
18,0 cm/7"

SCHEREN
SCISSORS
TIJERAS
CISEAUX
FORBICI

AC

nopa[®] instruments



AC SCHEREN SCISSORS TIJERAS CISEAUX FORBICI

Scheren für Neurochirurgie
 Scissors for Neuro Surgery
 Tijeras para neurocirugía
 Ciseaux pour neurochirurgie
 Forbici per neurochirurgia

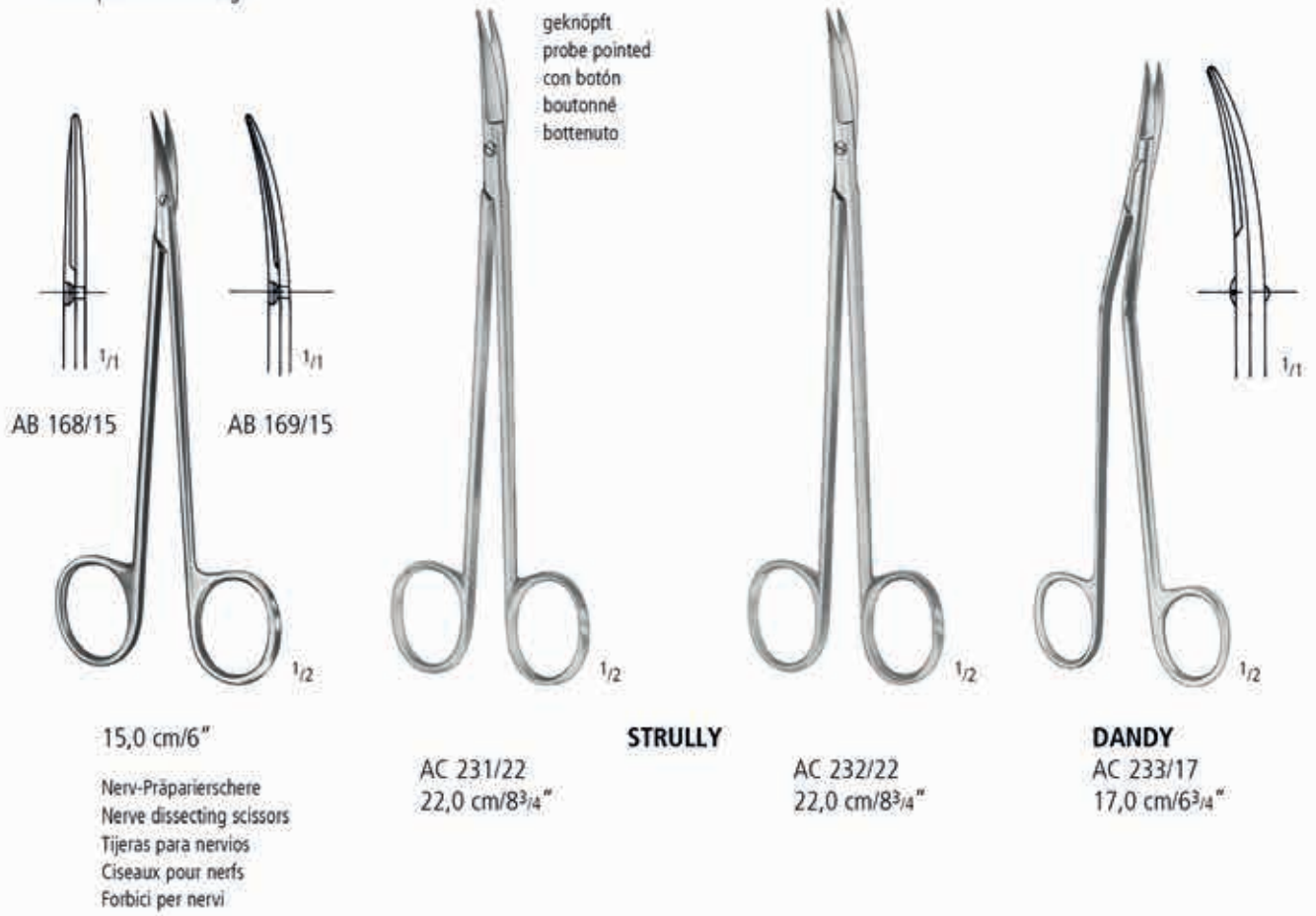

SCHMIEDEN-TAYLOR
 14,5 cm/5¹/₂" AC 241/15
 17,0 cm/6³/₄" AC 241/17



OLIVECRONA
 AC 259/23
 23,0 cm/9"

SCHEREN SCISSORS TIJERAS CISEAUX FORBICI

Mikroscheren
Micro Scissors
Micro Tijeras
Micro Ciseaux
Micro Forbici

- >> Alle unsere Mikroscheren werden von Fachkräften mit jahrelanger Erfahrung hergestellt. Die Endkontrolle findet unter dem Mikroskop statt. Um Ihnen ein ermüdungsfreies Arbeiten zu ermöglichen, wird dem Federdruck größte Aufmerksamkeit gewidmet.
- >> Bitte wählen Sie unter Rund- oder Flachgriffscheren.

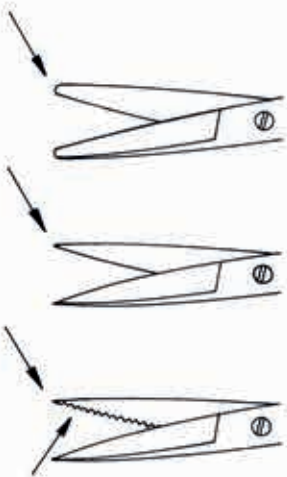

Dissection: **Gebogene Blätter, abgerundete Spitzen** ermöglichen eine gute und sichere Dissektion, ohne Nerven und Blutgefäße zu beschädigen.

Adventitia: **Gerade Blätter, sehr scharfe Spitzen** gewährleisten präzises Anfrischen von Gefäßenden.

Nerve: Ein Blatt ist **fein gezahnt**, um ein Herausgleiten des Nervs zu vermeiden.

- >> All our Micro Scissors are manufactured by skilled craftsmen with many years of experience. Final inspection is carried out under a microscope. Careful attention is paid to the closing pressure of the spring handle, to ensure precise work during surgeries, without fatigue.
- >> Round or flat handle scissors according to your preference.

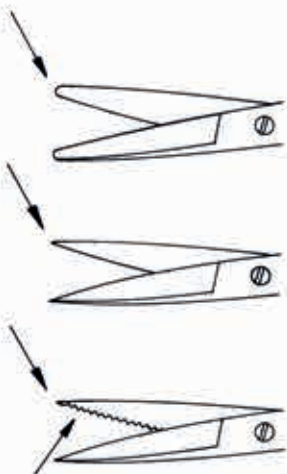

Dissection: **Curved blades, slightly rounded tips** ensure safe dissection without damage to nerves and vessels.

Adventitia: **Straight blades, very sharp tips** for finest trimming of vessel ends.

Nerve: One blade is **fine-toothed** to avoid slipping of the nerve.

AA
AB
AC
AE
AK
AO
AR
KA
KS
XR
XT

Mikroscheren
Micro Scissors
Micro Tijeras
Micro Ciseaux
Micro Forbici



14,5 cm/5 1/2"

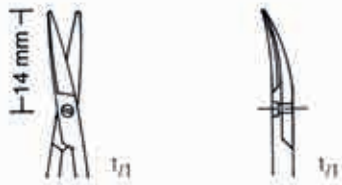

Dissection
AC 801/15



Adventitia
AC 803/15



18,0 cm/7"



Dissection
AC 801/18



Adventitia
AC 803/18

SCHEREN SCISSORS TIJERAS CISEAUX FORBICI

Mikroscheren
Mikro Scissors
Micro Tijeras
Micro Ciseaux
Micro Forbici

AA

AB

AC

AE

AK

AO

AB

KA

KS

XR

XT

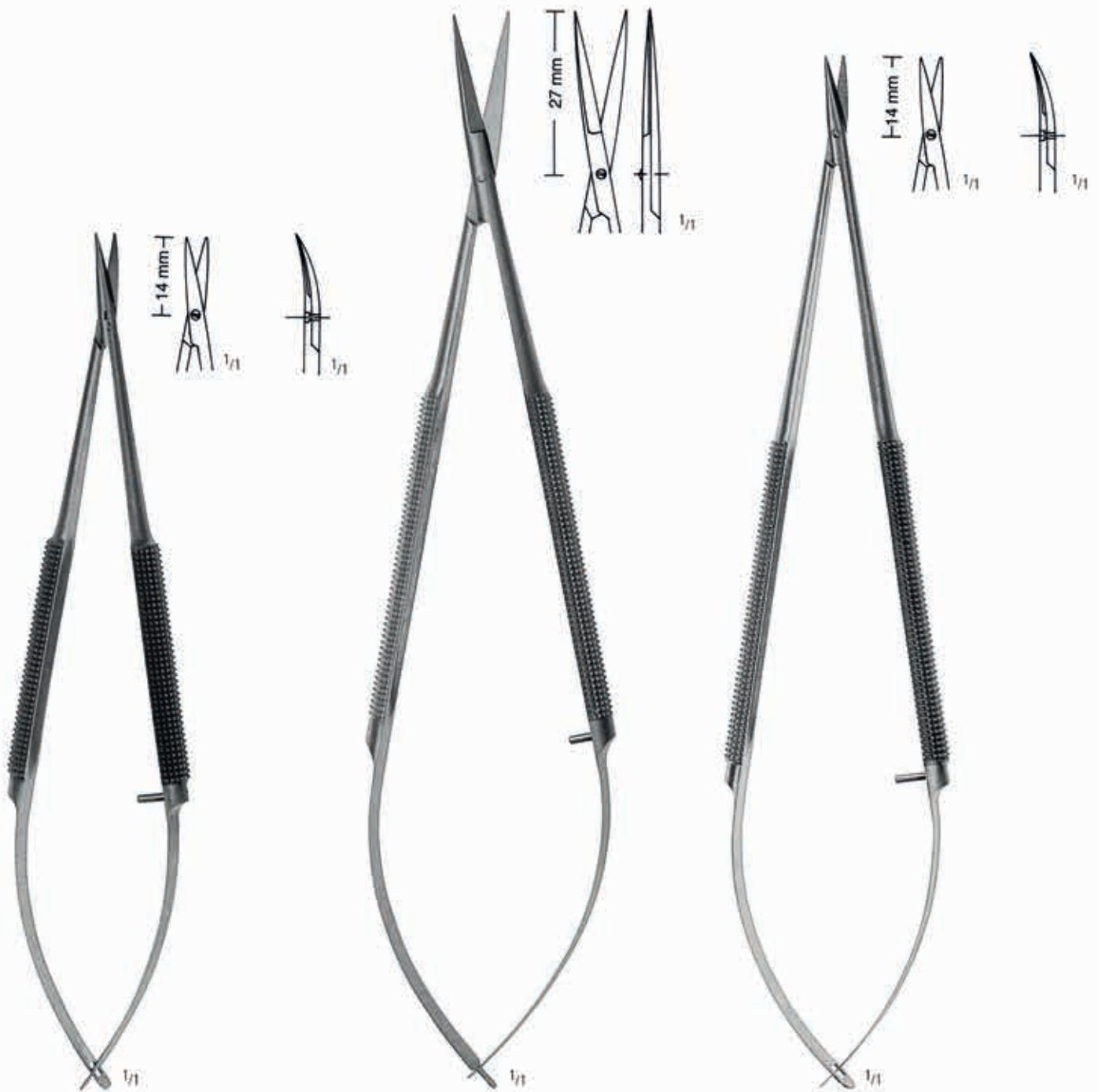

AC 807/14
14,5 cm/5½"

AC 812/18
18,0 cm/7"

AC 817/18
18,0 cm/7"

Mikroscheren
Micro Scissors
Micro Tijeras
Micro Ciseaux
Micro Forbici



11,0 cm/4 1/2"

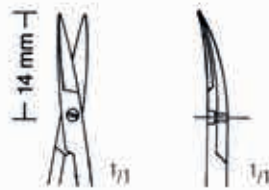

Dissection
AC 821/11

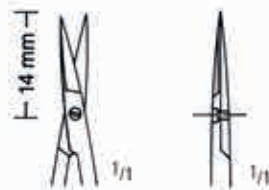

Adventitia
AC 830/11



15,0 cm/6"

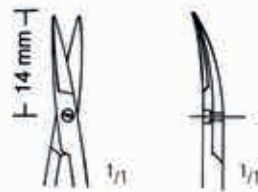

Dissection
AC 823/15

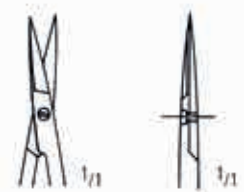

Adventitia
AC 832/15

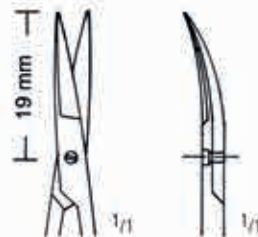

Dissection
AC 825/15

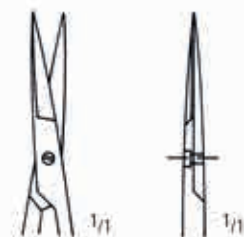

Adventitia
AC 834/15

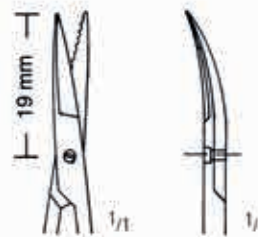

Dissection
AC 827/15

>> Nerve >> Adventitia
AC 836/15

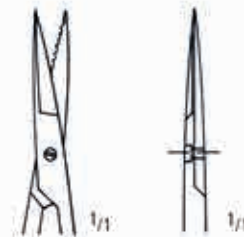

SCHEREN SCISSORS TIJERAS CISEAUX FORBICI

Mikroschere
Micro Scissors
Micro Tijeras
Micro Ciseaux
Micro Forbici

AA

AB

AC

AE

AK

AO

AB

KA

KS

XR

XT



18,5 cm/7 1/4"



AC 850/19



AC 851/19



16,0 cm/6 1/4"
20,0 cm/8"
22,5 cm/9"



AC 860/16
AC 860/20
AC 860/22



AC 861/16
AC 861/20
AC 861/22



AC 862/16
AC 862/20
AC 862/22



AC 863/16
AC 863/20
AC 863/22



AC 864/16
AC 864/20
AC 864/22



AC 865/16
AC 865/20
AC 865/22

AC SCHEREN SCISSORS TIJERAS CISEAUX FORBICI

Mikroscheren
Micro Scissors
Micro Tijeras
Micro Ciseaux
Micro Forbici



18,0 cm/7"



AC 870/01
25°



AC 870/02
45°



AC 870/03
60°



AC 870/04
90°



AC 870/05
125°



18,0 cm/7"



AC 871/01
25°



AC 871/02
45°



AC 871/03
60°



AC 871/04
90°



AC 871/05
125°

SCHEREN SCISSORS TIJERAS CISEAUX FORBICI

Scheren mit Hartmetalleinlagen
 Scissors with Tungsten Carbide Inserts
 Tijeras con filos de carburo de tungsteno
 Ciseaux avec plaquettes en carbure de tungstène
 Forbici con taglio al carburo di tungsteno

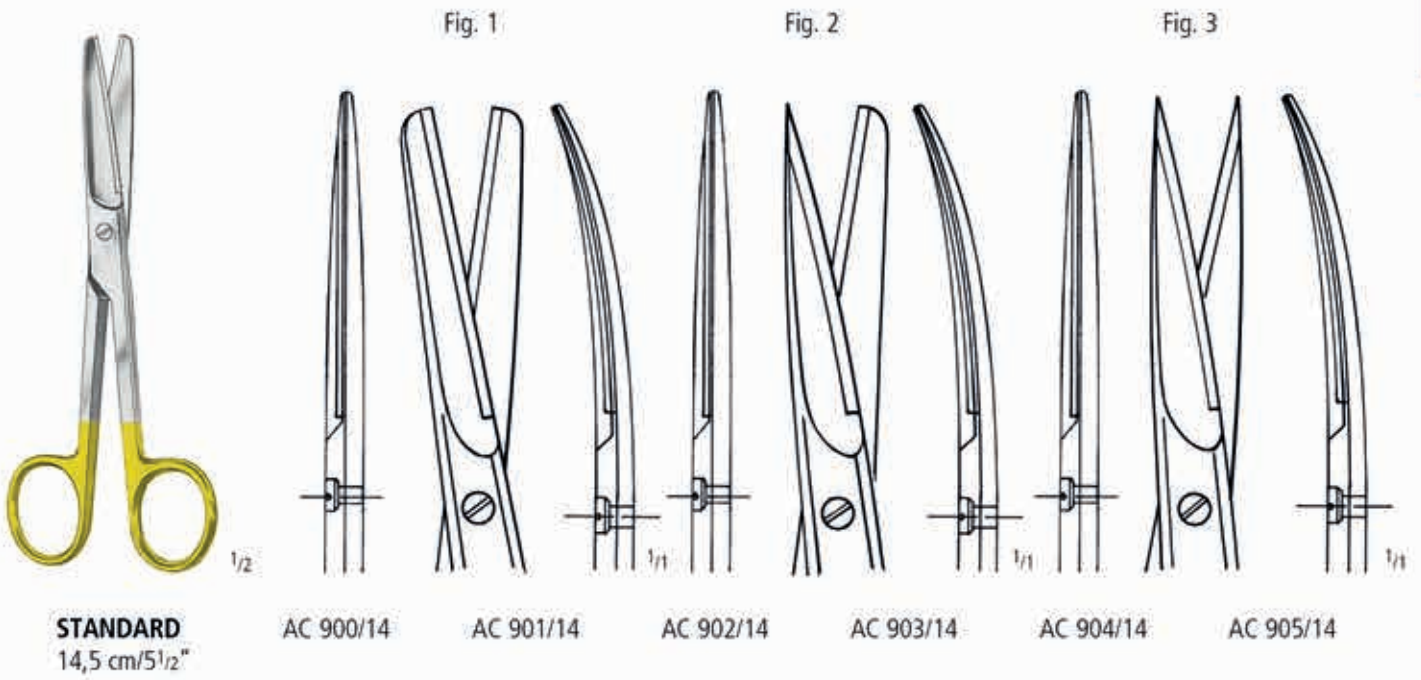

nopa®
TUC



AC SCHEREN SCISSORS TIJERAS CISEAUX FORBICI

Scheren mit Hartmetalleinlagen
 Scissors with Tungsten Carbide Inserts
 Tijeras con filos de carburo de tungsteno
 Ciseaux avec plaquettes en carbure de tungstène
 Forbici con taglio al carburo di tungsteno



Original 18,0 cm

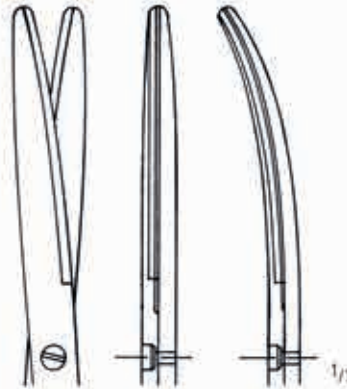

Original 20,0 cm

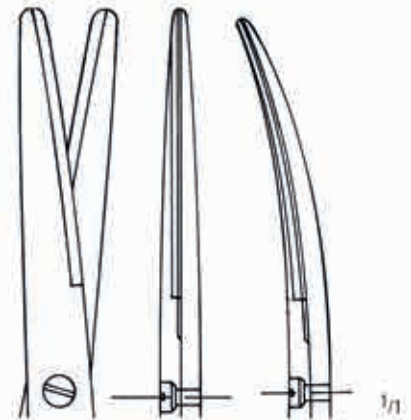

Original 23,0 cm



METZENBAUM



nopa[®]
TUC

gerade
 straight
 rectas
 droits
 retta

gebogen
 curved
 curvas
 courbes
 curva

AC 940/18	18,0 cm/7"	AC 941/18
AC 940/20	20,0 cm/8"	AC 941/20
AC 940/23	23,0 cm/9"	AC 941/23
AC 940/25	25,0 cm/10"	AC 941/25
AC 940/28	28,0 cm/11"	AC 941/28
AC 940/30	30,0 cm/12"	AC 941/30

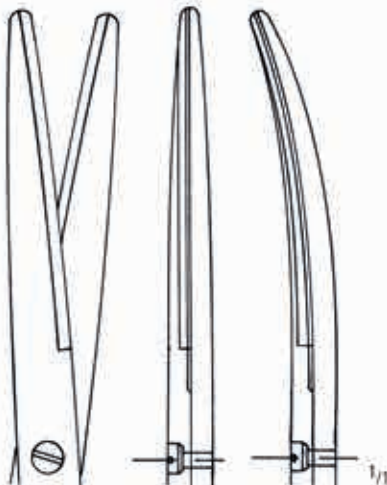

Original 25,0 cm

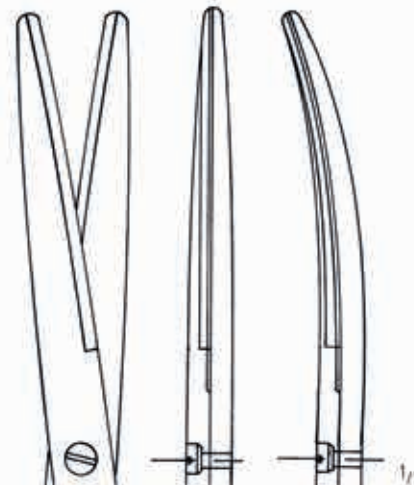

Original 28,0 cm

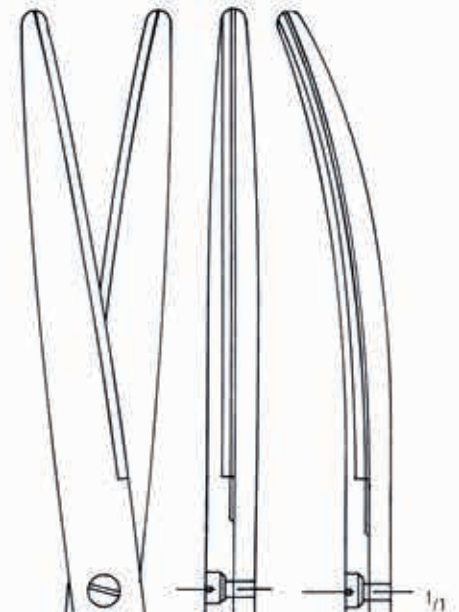

Original 30,0 cm

SCHEREN SCISSORS TIJERAS CISEAUX FORBICI

Scheren mit Hartmetalleinlagen
 Scissors with Tungsten Carbide Inserts
 Tijeras con filos de carburo de tungsteno
 Ciseaux avec plaquettes en carbure de tungstène
 Forbici con taglio al carburo di tungsteno



LEXER
 AC 952/16
 16,0 cm/6 1/4"

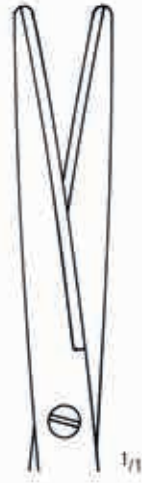

LEXER
 AC 953/16
 16,0 cm/6 1/4"



AC 960/14
 14,5 cm/5 1/2"



AC 961/14
 14,5 cm/5 1/2"



AC 962/14
 14,5 cm/5 1/2"



AC 963/14
 14,5 cm /5 1/2"

METZENBAUM-DELICATE

AA
 AB
AC
 AE
 AK
 AO
 AB
 KA
 KS
 XR
 XT

AC SCHEREN SCISSORS TIJERAS CISEAUX FORBICI

Scheren mit Hartmetalleinlagen
 Scissors with Tungsten Carbide Inserts
 Tijeras con filos de carburo de tungsteno
 Ciseaux avec plaquettes en carbure de tungstène
 Forbici con taglio al carburo di tungsteno

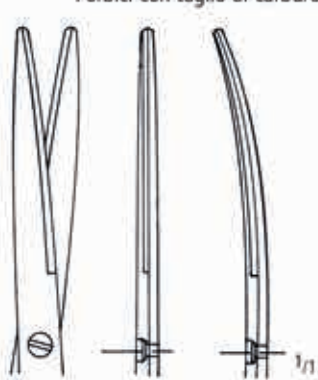

Original 18,0 cm

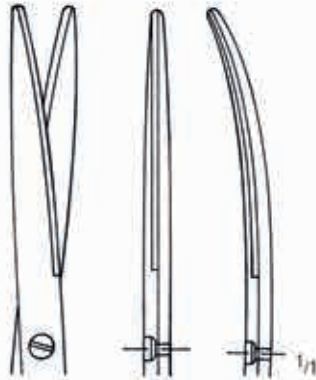

Original 20,0 cm

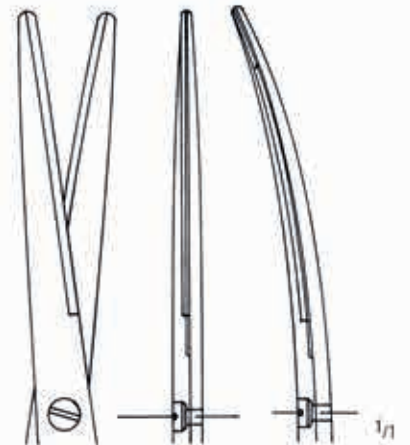

Original 23,0 cm



METZENBAUM-DELICATE

nopa®
TUC

gerade
 straight
 rectas
 droits
 retta

gebogen
 curved
 curvas
 courbes
 curva

AC 970/18	18,0 cm/7"	AC 971/18
AC 970/20	20,0 cm/8"	AC 971/20
AC 970/23	23,0 cm/9"	AC 971/23
AC 970/25	25,0 cm/10"	AC 971/25
AC 970/28	28,0 cm/11"	AC 971/28

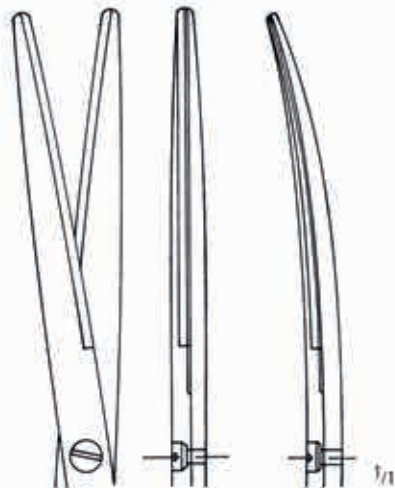

Original 25,0 cm

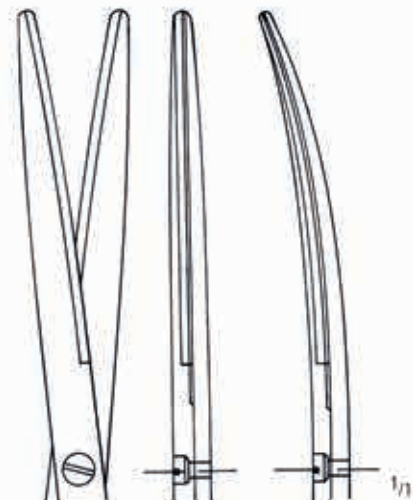

Original 28,0 cm

SCHEREN SCISSORS TIJERAS CISEAUX FORBICI

Scheren mit Hartmetalleinlagen
 Scissors with Tungsten Carbide Inserts
 Tijeras con filos de carburo de tungsteno
 Ciseaux avec plaquettes en carbure de tungstène
 Forbici con taglio al carburo di tungsteno



TOENNIS-ADSON-DELICATE
 AC 977/17
 17,5 cm/7"



AC 980/13
 13,0 cm/5"

GOLDMAN-FOX



AC 981/13
 13,0 cm/5"



Weitere Scheren siehe Katalog A 98-157.
 For further scissors see catalogue A 98-157.
 Para otras tijeras ver catálogo A 98-157.
 D'autres ciseaux voir notre catalogue A 98-157.
 Altre forbici consultare il nostro catalogo A 98-157.



AC 984/11
 11,5 cm/4 1/2"



AC 985/11
 11,5 cm/4 1/2"



UNIVERSAL
 AC 987/12
 12,0 cm/4 3/4"



LISTER
 AC 999/18
 18,0 cm/7"

AA
 AB
AC
 AE
 AK
 AO
 AR
 KA
 KS
 XR
 XT

NAHT
SUTURE
SUTURA
SUTURE
SUTURA

AE

nopa[®] instruments



AE NAHT SUTURE SUTURA SUTURE SUTURA

Nadelhalter mit Hartmetalleinsätzen
 Needle Holders with Tungsten Carbide Inserts
 Porta-agujas con bocas de carburo de tungsteno
 Porte-aiguilles à mors en carbure de tungstène
 Portaghi con placche di carburo di tungsteno



MAYO-HEGAR



AE 400/14
14,0 cm/5 1/2"



AE 400/16
16,0 cm/6 1/4"



AE 400/18
18,0 cm/7"



AE 400/20
20,0 cm/8"



AE 400/24
24,0 cm/9 1/2"



AE 400/26
26,0 cm/10 1/4"



AE 400/30
30,0 cm/12"



**DE BAKEY
 (MAYO-HEGAR-DELICATE)**



AE 420/18
18,0 cm/7"



AE 420/20
20,0 cm/8"



AE 420/23
23,0 cm/9"



AE 420/26
26,0 cm/10 1/4"



AE 420/31
31,0 cm/12 1/4"

NAHT SUTURE SUTURA SUTURE SUTURA

Nadelhalter mit Hartmetalleinsätzen
 Needle Holders with Tungsten Carbide Inserts
 Porta-agujas con bocas de carburo de tungsteno
 Porte-aiguilles à mors en carbure de tungstène
 Portaghi con placche di carburo di tungsteno



MICRO RYDER

					
AE 434/13 13,0 cm/5"	AE 434/15 15,0 cm/6"	AE 434/18 18,0 cm/7"	AE 434/20 20,0 cm/8"	AE 434/23 23,0 cm/9"	AE 434/26 26,0 cm/10 ¹ / ₄ "



CONVERSE
 AE 452/12
 12,5 cm/5"



NEIVERT
 AE 456/13
 13,0 cm/5"



HALSEY
 13,0 cm/5"

AA
 AB
 AC
AE
 AK
 AO
 AB
 KA
 KS
 XR
 XT

AE NAHT SUTURE SUTURA SUTURE SUTURA

Nadelhalter mit Hartmetalleinsätzen
 Needle Holders with Tungsten Carbide Inserts
 Porta-agujas con bocas de carburo de tungsteno
 Porte-aiguilles à mors en carbure de tungstène
 Portaghi con placche di carburo di tungsteno



BABY-CRILE-WOOD
 AE 468/15
 15,0 cm/6"



CRILE-WOOD
 AE 469/15
 15,0 cm/6"



CRILE-WOOD
 AE 470/15
 15,0 cm/6"



CRILE-WOOD



AE 470/18
 18,0 cm/7"



AE 470/20
 20,0 cm/8"



AE 470/23
 23,0 cm/9"



AE 471/18
 18,0 cm/7"



AE 471/23
 23,0 cm/9"

nopa[®]
TUC

NAHT SUTURE SUTURA SUTURE SUTURA

Nadelhalter mit Hartmetalleinsätzen
 Needle Holders with Tungsten Carbide Inserts
 Porta-agujas con bocas de carburo de tungsteno
 Porte-aiguilles à mors en carbure de tungstène
 Portaghi con placche di carburo di tungsteno

AA

AB

AC

AE

AK

AO

AB

KA

KS

XR

XT



MATHIEU



AE 500/14
14,0 cm/5 1/2"



AE 500/17
17,0 cm/6 3/4"



AE 500/20
20,0 cm/8"



AE 500/24
24,0 cm/9 1/2"



MATHIEU-DELICATE



AE 504/14
14,0 cm/5 1/2"



AE 504/17
17,0 cm/6 3/4"



AE 504/20
20,0 cm/8"



MATHIEU-RYDER MICRO



AE 512/17
17,0 cm/6 3/4"



AE 512/20
20,0 cm/8"



AE 512/24
24,0 cm/9 1/2"



LANGENBECK



AE 540/16
16,0 cm/6 1/4"



AE 540/18
18,0 cm/7"



AE 540/20
20,0 cm/8"

AE NAHT SUTURE SUTURA SUTURE SUTURA

Nadelhalter mit Hartmetalleinsätzen
 Needle Holders with Tungsten Carbide Inserts
 Porta-agujas con bocas de carburo de tungsteno
 Porte-aiguilles à mors en carbure de tungstène
 Portaghi con placche di carburo di tungsteno

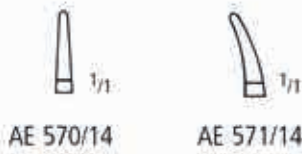

CASTROVIEJO
 14,0 cm/5½"



CASTROVIEJO
 14,0 cm/5½"

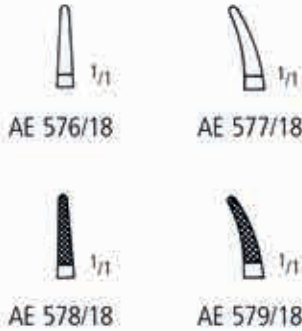

18,0 cm/7"



JACOBSON
 21,0 cm/8¼"

NAHT SUTURE SUTURA SUTURE SUTURA

Mikro-Nadelhalter mit Rundgriff
 Micro-Needle Holders with pen-type handle
 Micro-porta-agujas con mango redondo
 Micro-porte-aiguilles à manches rondes
 Micro-portaghi con manici rotondi



AE 630/18
 18,0 cm/7¹/₄"



AE 631/18
 18,0 cm/7¹/₄"



AE 632/18
 18,0 cm/7¹/₄"



AE 633/18
 18,0 cm/7¹/₄"

AA
 AB
 AC
AE
 AK
 AO
 AB
 KA
 KS
 XR
 XT

Mikro-Nadelhalter
 Micro-Needle-Holders
 Micro-porta-agujas
 Micro-porte-aiguilles
 Micro-portaghi



JACOBSON
 AE 678/18
 18,0 cm/7"



AE 680/16
 AE 680/18
 AE 680/20
 AE 680/22

16,0 cm/6 1/2"
 18,0 cm/7"
 20,0 cm/8"
 22,0 cm/9"



AE 681/16
 AE 681/18
 AE 681/20
 AE 681/22

Weitere Nadelhalter siehe Katalog A 176-209 und Gruppe KS.
 For further needle holders see catalogue A 176-209 and section KS.
 Para otras porta-agujas ver catálogo A 176-209 y sección KS.
 D'autres porte-aiguilles voir notre catalogue A 176-209 et groupe KS.
 Per altri portaghi consultare il nostro catalogo A 176-209 e gruppo KS.

WUNDHAKEN
RETRACTORS
SEPARADORES
ECARTEURS
DIVARICATORI

AK

nopa[®] instruments



Feine Wundhaken
 Delicate Hooks
 Ganchos
 Crochets très fins
 Divaricatori sottili



GILLIES
 AK 020/01
 18,0 cm/7"

GILLIES
 AK 020/02
 18,0 cm/7"

KILNER
 AK 022/15
 15,0 cm/6"

FRAZIER
 AK 024/13
 13,0 cm/5"

AK 026/01

KLEINERT-KUTZ
 AK 026/02
 16,0 cm/6¼"

AK 026/03

WUNDHAKEN RETRACTORS SEPARADORES ECARTEURS DIVARICATORI

Feine Wundhaken
Delicate Hooks
Ganchos
Crochets très fins
Divaricatori sottili

AA

AB

AC

AE

AK

AO

AB

KA

KS

XR

XT



CUSHING
28,0 cm/11"



AK 034/01



AK 034/02



CUSHING
19,0 cm/7¹/₄"



AK 036/01



AK 036/02



MOLDESTAD
AK 038/13
13,0 cm/5"



17,0 cm/6³/₄"



AK 040/05
5 mm



AK 040/07
7 mm



AK 042/10
Ø 1,0 mm



AK 042/12
Ø 1,2 mm



18,5 cm/7¹/₄"

Weitere feine Wundhaken siehe Gruppe KS.
For further delicate hooks see section KS.
Para otros ganchos ver sección KS.
D'autres crochets très fins voir groupe KS.
Per altri divaricatori sottili vedi gruppo KS.



AK 044/11
11,0 cm/4¹/₄"

Spinalhaken
 Spinal Retractors
 Separadores espinales
 Ecarteurs spinals
 Divaricatori spinali



CUSHING
 AK 130/20
 20,0 cm/8"



TAYLOR
 16,5 cm/6 1/2"

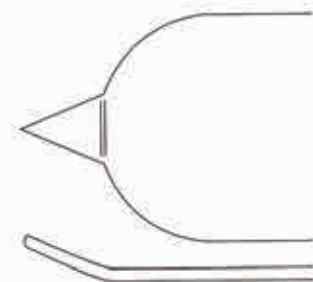

AK 132/07
 75 x 30 mm

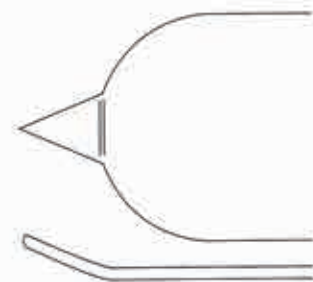

AK 132/10
 100 x 30 mm



AK 320/16
50 x 16 mm



AK 320/25
75 x 25 mm



AK 320/50
90 x 50 mm

MEYERDING
22,5 cm/9"

Selbsthaltende Wundsperrer
 Selfretaining Retractors
 Separadores autoestaticos
 Ecarteurs autostatiques
 Divaricatori autostatici



ALM

- | | | | | |
|---|--|-----------|------------|-----------|
| △ | 7,0 cm/2 ³ / ₄ " | AK 506/07 | 10,0 cm/4" | AK 506/10 |
| ○ | | AK 507/07 | | AK 507/10 |



JANSEN

- | | | | |
|------------|-----------|---|-----------|
| △ | AK 510/10 | ○ | AK 511/10 |
| 10,0 cm/4" | | | |



JANSEN

- | | | | |
|------------|-----------|---|-----------|
| △ | AK 512/10 | ○ | AK 513/10 |
| 10,0 cm/4" | | | |



SNITMAN

- | | | | |
|---|-----------|---|-----------|
| △ | AK 514/10 | ○ | AK 515/10 |
| 10,5 cm/4 ¹ / ₄ " | | | |

WUNDHAKEN RETRACTORS SEPARADORES ECARTEURS DIVARICATORI

Selbsthaltende Wundsperrer
Selfretaining Retractors
Separadores autoestaticos
Ecarteurs autostatiques
Divaricatori autostatici



WEITLANER

10,5 cm/4 1/4"
13,0 cm/5"
16,5 cm/6 1/2"
20,0 cm/8"
25,0 cm/10"
26,0 cm/10 1/2"

2 x 3
3 x 4
3 x 4
3 x 4
3 x 4
5 x 6

AK 522/10
AK 524/13
AK 526/16
AK 528/20
AK 530/25
AK 532/26

AK 523/10
AK 525/13
AK 527/16
AK 529/20
AK 531/25
AK 533/26



ANDERSON-ADSON

AK 556/20

AK 557/20

20,0 cm/8"

AA
AB
AC
AE
AK
AO
AR
KA
KS
XR
XT

Selbsthaltende Wundsperrer
 Selfretaining Retractors
 Separadores autoestaticos
 Ecarteurs autostatiques
 Divaricatori autostatici



ADSON
 AK 560/27
 27,0 cm/10¹/₂"



ADSON - R
 AK 561/01
 27,0 cm/10¹/₂"



ADSON - L
 AK 561/02
 27,0 cm/10¹/₂"

WUNDHAKEN RETRACTORS SEPARADORES ECARTEURS DIVARICATORI

Selbsthaltende Wundsperrer
Selfretaining Retractors
Separadores autoestaticos
Ecarteurs autostatiques
Divaricatori autostatici



CONE

13,0 cm/5"
16,5 cm/6 1/2"
20,0 cm/8"
25,0 cm/10"

3 x 4
3 x 4
3 x 4
3 x 4

△
AK 564/13
AK 564/16
AK 564/20
AK 564/25

∩
AK 565/13
AK 565/16
AK 565/20
AK 565/25



BECKMANN

31,0 cm/12"
33,0 cm/13"

4 x 4
4 x 5

△
AK 566/31
AK 568/33

∩
AK 567/31
AK 569/33

AA
AB
AC
AE
AK
AO
AB
KA
KS
XR
XT

Selbsthaltende Wundsperrer
 Selfretaining Retractors
 Separadores autoestaticos
 Ecarteurs autostatiques
 Divaricatori autostatici



25 x 25 mm
 25 x 31 mm
 25 x 40 mm
 25 x 45 mm

BECKMANN-ADSON
 31,0 cm/12"



AK 570/01
 AK 570/02
 AK 570/03
 AK 570/04



AK 571/01
 AK 571/02
 AK 571/03
 AK 571/04



BECKMANN-EATON
 AK 572/33 AK 573/33
 33,0 cm/13"

Selbsthaltende Wundsperrer
Selfretaining Retractors
Separadores autoestáticos
Ecarteurs autostatiques
Divaricatori autostatici



SCALP-CONTOUR

AK 574/14

AK 575/14

14,0 cm/5 1/2"

Weitere Wundhaken siehe Katalog A 239-294 und Gruppe KS.
For further retractors see catalogue A 239-294 and section KS.
Para otros separadores ver catálogo A 239-294 y sección KS.
D'autres écarteurs voir notre catalogue A 239-294 et groupe KS.
Per altri divaricatori consultare il nostro catalogo A 239-294 e gruppo KS.

AA

AB

AC

AE

AK

AO

AB

KA

KS

XR

XT

PUNKTION/KANÜLEN
PUNCTURE/SPECIAL NEEDLES
PUNCION/AGUJAS ESPECIALES
PUNCTION/AIGUILLES SPECIALES
PUNTURA/AGHI SPECIALI

A0

nopa[®] instruments



Saugröhre
Suction Tubes
Tubos de aspiración
Canules d'aspiration
Cannule di aspirazione

complete with suction tube
+ cannula 0,4 mm
+ cannula 0,6 mm
+ cannula 0,8 mm



FRAZIER
6 Charr. AO 430/06
8 Charr. AO 430/08
10 Charr. AO 430/10
12 Charr. AO 430/12

PLESTER
1,5 mm AO 432/15
2,0 mm AO 432/20
2,5 mm AO 432/25
3,0 mm AO 432/30

FERGUSSON
5 Charr. AO 434/05
6 Charr. AO 434/06
7 Charr. AO 434/07
8 Charr. AO 434/08
9 Charr. AO 434/09
10 Charr. AO 434/10
12 Charr. AO 434/12

**WULLSTEIN
MICRO**
AO 438/00

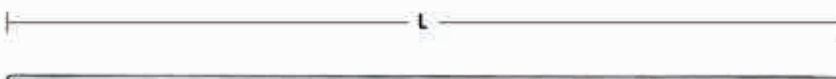

	L	L	L	L
	130 mm	150 mm	180 mm	220 mm
Ø 1,5 mm	AO 440/13	AO 440/15	AO 440/18	AO 440/22
Ø 2,0 mm	AO 441/13	AO 441/15	AO 441/18	AO 441/22
Ø 2,5 mm	AO 442/13	AO 442/15	AO 442/18	AO 442/22
Ø 3,5 mm	AO 443/13	AO 443/15	AO 443/18	AO 443/22



ADSON
AO 450/04
21,0 cm/8 1/4"
4,0 mm

DIAGNOSTIK
DIAGNOSTICS
DIAGNOSTICO
DIAGNOSTIC
DIAGNOSTICA

AR

nopa[®] instruments



Perkussionshämmer
 Percussion Hammers
 Martillos de percusión
 Marteaux-percuteurs
 Martelli percussori



BUCK
 AR 200/18
 18,0 cm/7"

BABINSKY
 AR 205/22
 22,0 cm/8³/₄"
 Ø 40 mm

RABINER
 AR 208/23
 23,0 cm/9"
 Ø 40 mm

TAYLOR
 18,0 cm/7" AR 215/18
 20,0 cm/8" AR 215/20

Perkussionshämmer
 Percussion Hammers
 Martillos de percusión
 Marteaux-percuteurs
 Martelli percussori

AA
 AB
 AC
 AE
 AK
 AO
 AR
 KA
 KS
 XR
 XT



TROEMNER
 AR 216/24
 24,0 cm/9 1/2"



DÉJERINE
 AR 217/20
 20,0 cm/8"



DÉJERINE
 AR 218/20
 20,0 cm/8"

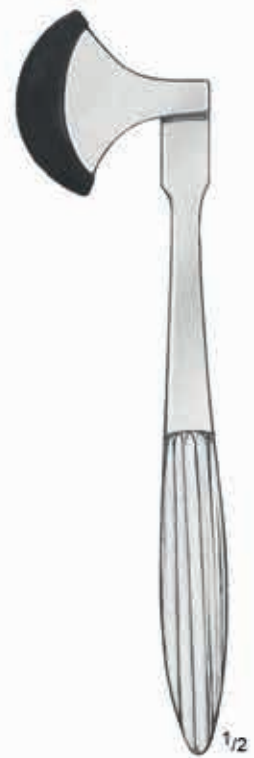

BERLINER
 AR 220/20
 20,0 cm/8"

Sensibilitäts-Instrumente
 Sensibility Instruments
 Instrumentos sensibilidad
 Instruments sensibilités
 Strumenti per sensibilità



ALY
 AR 300/00
 19,0 cm/7 1/2"



WARTENBERG
 AR 301/00
 19,0 cm/7 1/2"

ORTHOPÄDIE
ORTHOPAEDICS
ORTOPEDIA
ORTHOPEDIE
ORTOPEDIA

KA

nopa[®] instruments



Handbohrapparate
Hand Drills
Perforadores de mano
Perforateurs à main
Perforatori a mano



← KA 060/90

STILLE
KA 060/00
20,0 cm/8"

komplett mit
complete with
completo con
complet avec
completo con

Fig. 1-9
Fig. 1-9
Fig. 1-9
Fig. 1-9
Fig. 1-9



Fig. 1
KA 060/01
Ø 2,5 mm



Fig. 2
KA 060/02
Ø 3,0 mm



Fig. 3
KA 060/03
Ø 3,5 mm



Fig. 4
KA 060/04
Ø 4,0 mm



Fig. 5
KA 060/05
Ø 10,0 mm



Fig. 6
KA 060/06
Ø 5,0 mm



Fig. 7
KA 060/07
Ø 8,0 mm



Fig. 8
KA 060/08
Ø 12,0 mm



Fig. 9
KA 060/09
Ø 16,0 mm



Fig. 10
KA 060/10
Ø 1,0 mm



Fig. 11
KA 060/11
Ø 1,5 mm



Fig. 12
KA 060/12
Ø 2,0 mm

Handbohrapparate
Hand Drills
Perforadores de mano
Perforateurs à main
Perforatore a mano



RALK
KA 100/00



Ø 1,0 mm	KA 102/10
Ø 1,5 mm	KA 102/15
Ø 2,0 mm	KA 102/20
Ø 2,7 mm	KA 102/27
Ø 3,0 mm	KA 102/30
Ø 3,2 mm	KA 102/32
Ø 3,5 mm	KA 102/35
Ø 4,0 mm	KA 102/40
Ø 4,5 mm	KA 102/45
Ø 5,0 mm	KA 102/50
Ø 6,0 mm	KA 102/60
Ø 7,0 mm	KA 102/70
Ø 8,0 mm	KA 102/80
Ø 9,0 mm	KA 102/90
Ø 10,0 mm	KA 102/99

AA

AB

AC

AE

AK

AO

AB

KA

K5

XR

XT

Maßtabelle
 Scale
 Tabla de medida
 Tableau de la mesure
 Scala



2,0 mm



3,0 mm



4,0 mm



5,0 mm



6,0 mm



8,0 mm



10,0 mm



12,0 mm



14,0 mm



16,0 mm



18,0 mm



20,0 mm



25,0 mm



30,0 mm



35,0 mm



40,0 mm



45,0 mm



50,0 mm

AA

AB

AC

AE

AK

AO

AR

KA

K5

XR

XT

Meißel und Osteotome
 Chisels, Gouges and Osteotomes
 Cinceles y Gubias
 Ciseaux-Burins et Ostéotomes
 Scalpelli, Osteotomi, Sgorbie



1/2

MINI-LEXER

18,0 cm/7"



1/2

MINI-LEXER

18,0 cm/7"



1/2

LEXER

22,0 cm/8³/₄"



1/2

LEXER

22,0 cm/8³/₄"

mm

- 4 KA 470/04
- 6 KA 470/06
- 7
- 8 KA 470/08
- 10 KA 470/10
- 12 KA 470/12
- 15 KA 470/15
- 20 KA 470/20
- 25
- 30

- KA 471/04
- KA 471/06
- KA 471/08
- KA 471/10
- KA 471/12
- KA 471/15
- KA 471/20

- KA 472/07
- KA 472/10
- KA 472/15
- KA 472/20
- KA 472/25
- KA 472/30

- KA 473/07
- KA 473/10
- KA 473/15
- KA 473/20
- KA 473/25
- KA 473/30

Ferrozellgriff
 Hartpress-Handle
 Mango en "Ferrozell"
 Manche en "Ferrozell"
 Manico in "Ferrozell"

Meißel und Osteotome
 Chisels, Gouges and Osteotomes
 Cinceles y Gubias
 Ciseaux-Burins et Ostéotomes
 Scalpelli, Osteotomi, Sgorbie

AA
 AB
 AC
 AE
 AK
 AO
 AR
 KA
 KS
 XR
 XT



1/2

LEXER
 27,5 cm/10³/₄"

mm
 5
 10 KA 474/10
 15 KA 474/15



1/2

LEXER
 27,5 cm/10³/₄"

KA 475/10
 KA 475/15



1/2

LEXER
 25,0 cm/10"

KA 476/05
 KA 476/10
 KA 476/15



1/2

LEXER
 25,0 cm/10"

KA 477/05
 KA 477/10
 KA 477/15

Ferrozellgriff
 Hartpress-Handle
 Mango en "Ferrozell"
 Manche en "Ferrozell"
 Manico in "Ferrozell"

Meißel und Osteotome
 Chisels, Gouges and Osteotomes
 Cinceles y Gubias
 Ciseaux-Burins et Ostéotomes
 Scalpelli, Osteotomi, Sgorbie

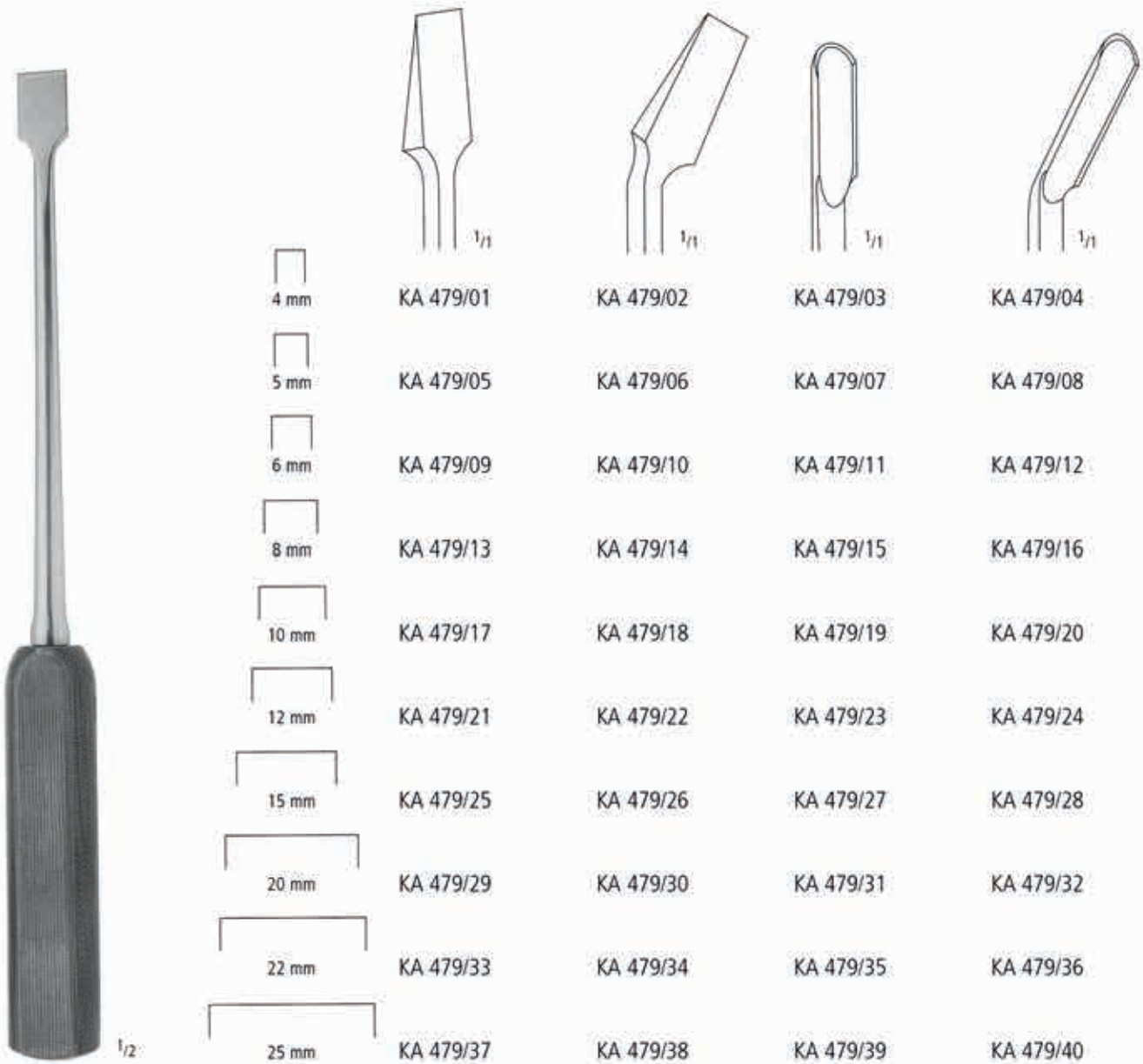

DAHMEN

30,0 cm/12"

Ferrozellgriff
 Hartpress-Handle
 Mango en "Ferrozell"
 Manche en "Ferrozell"
 Manico in "Ferrozell"

Hämmer
Mallets
Martillos
Marteaux
Martelli

AA

AB

AC

AE

AK

AO

AB

KA

KS

XR

XT



OMBREDANNE
KA 519/55
24,0 cm/9½"



COTTE
KA 531/24
19,0 cm/7½"



KA 534/14
18,0 cm/7"

Hämmer
Mallets
Martillos
Marteaux
Martelli



KA 554/90



370 g
(12³/₄ oz.)

KA 554/37
Ferrozell



125 g
(4¹/₄ oz.)

KA 555/13
Ferrozell

Scharfe Löffel
 Bone Curettes
 Cucharillas cortantes
 Curettes tranchantes
 Curette taglienti

AA
 AB
 AC
 AE
 AK
 AO
 AR
 KA
 KS
 XR
 XT



**CLOWARD
 HIBBS SPRATT
 SPINAL FUSION**
 22,5 cm/9"

- Fig. 000
KA 626/00
- Fig. 00
KA 627/00
- Fig. 0
KA 628/00
- Fig. 1
KA 628/01
- Fig. 2
KA 628/02
- Fig. 3
KA 628/03
- Fig. 4
KA 628/04
- Fig. 5
KA 628/05
- Fig. 6
KA 628/06



**CLOWARD
 HIBBS SPRATT
 SPINAL FUSION**
 22,5 cm/9"

- Fig. 000
KA 629/00
- Fig. 00
KA 630/00
- Fig. 0
KA 631/00
- Fig. 1
KA 631/01
- Fig. 2
KA 631/02
- Fig. 3
KA 631/03
- Fig. 4
KA 631/04
- Fig. 5
KA 631/05
- Fig. 6
KA 631/06

Elevatoren
Elevators
Elevadores
Elévateurs
Elevatori



LANGENBECK
19,5 cm/7³/₄"



FREER
19,0 cm/7¹/₂"



FREER
KA 703/18
18,0 cm/7"

Elevatori
Elevators
Elevadores
Élévateurs
Elevatori

AA

AB

AC

AE

AK

AO

AB

KA

K5

XR

XT



HOEN

7 mm



KA 704/07
16,0 cm/6 1/4"

15 mm

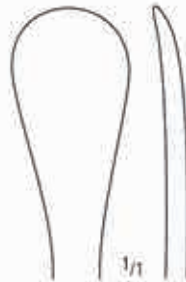

KA 704/15
19,0 cm/7 1/2"

20 mm

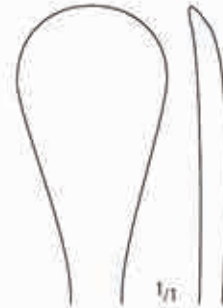

KA 704/20
19,0 cm/7 1/2"



ADSON
17,0 cm/6 3/4"



KA 705/01



KA 705/02



KA 705/03



KA 705/04

Hohlmeisselzangen
 Bone Rongeurs
 Pinzas-gubias
 Pincis-gouges
 Pinze-sgorbie

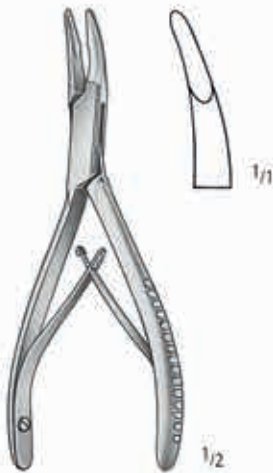

MINI-FRIEDMAN
 KA 800/12
 12,0 cm/5"



FRIEDMAN
 KA 800/14
 14,0 cm/5 1/2"

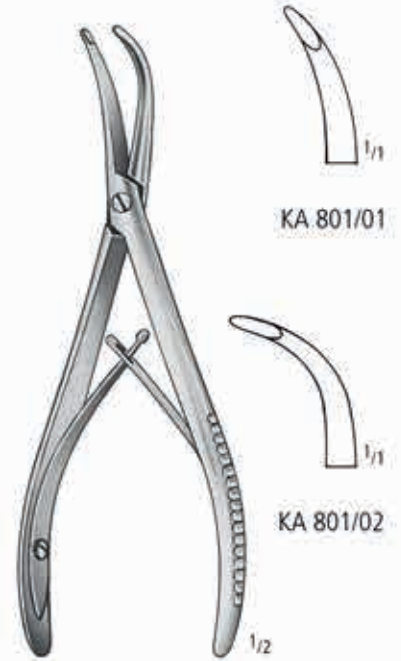

STELLBRINK
 17,0 cm/6 3/4"

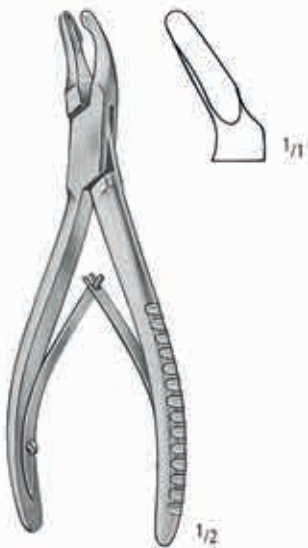

CLEVELAND
 KA 802/14
 14,0 cm/5 1/2"

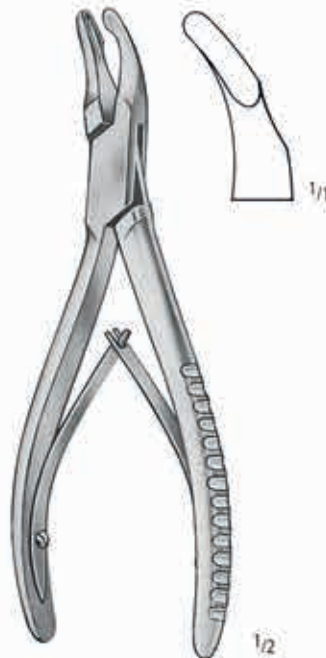

CLEVELAND
 KA 802/17
 17,0 cm/6 3/4"

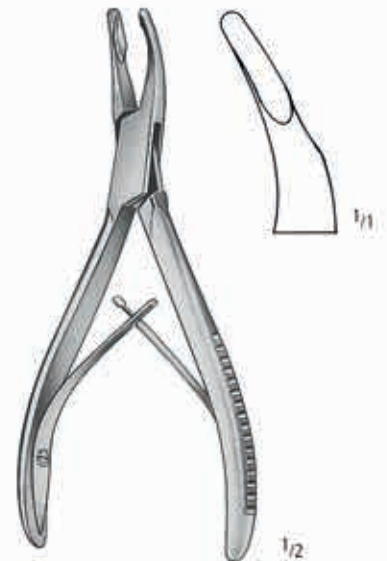

UNIVERSAL
 KA 803/13
 13,5 cm/5 1/4"

Hohlmeisselzangen
 Bone Rongeurs
 Pinzas-gubias
 Pincès-gouges
 Pinze-sgorbie

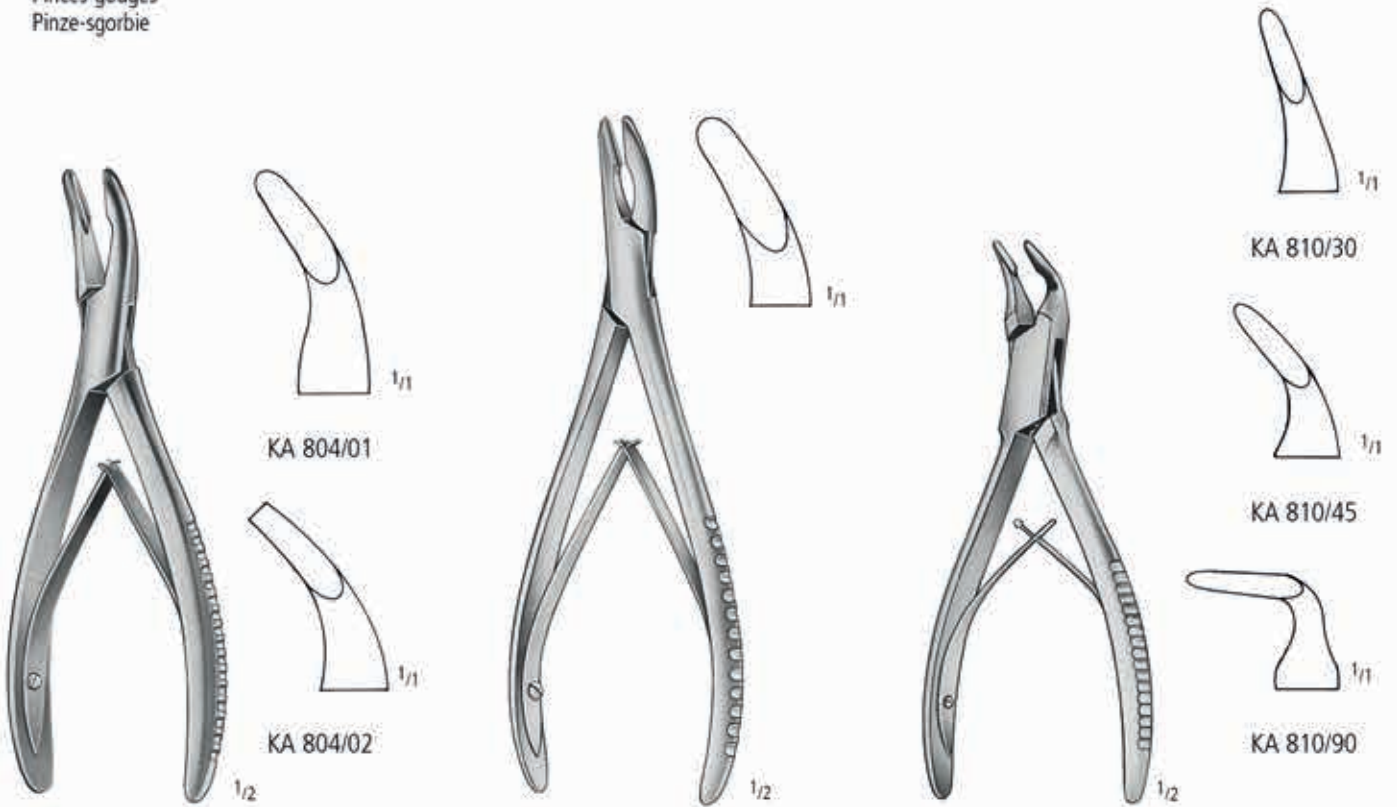

MEAD
 16,5 cm/6 1/2"

HARTMANN
 KA 807/18
 18,5 cm/7 1/4"

BLUMENTHAL
 15,5 cm/6"

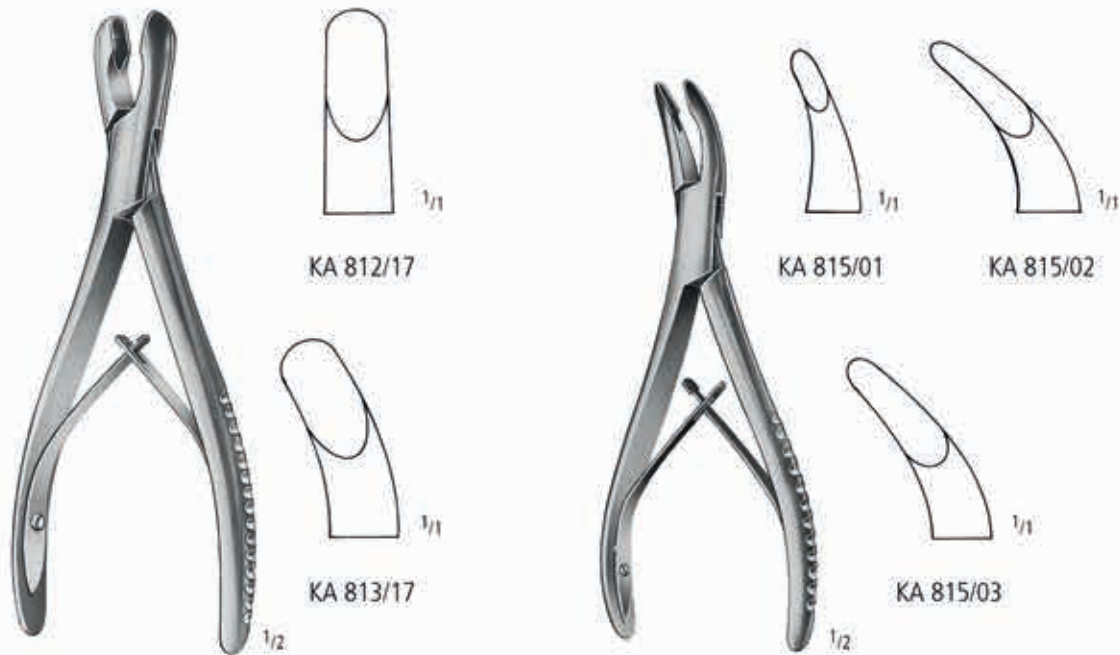

LUER
 17,0 cm/6 3/4"

LUER
 15,0 cm/6"

AA
 AB
 AC
 AE
 AK
 AO
 AR
 KA
 KS
 XR
 XT

Hohlmeisselzangen
 Bone Rongeurs
 Pinzas-gubias
 Pincès-gouges
 Pinze-sgorbie



LEMPERT
 KA 816/19
 19,0 cm/7½"



BACON
 KA 819/20
 20,0 cm/8"



MARQUARDT
 KA 821/20
 20,0 cm/8"

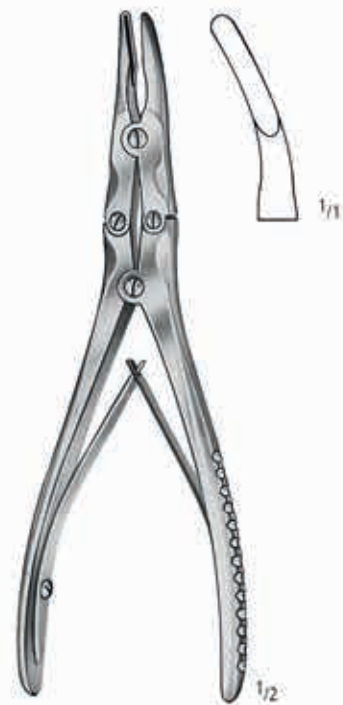

MAYFIELD
 KA 823/17
 17,0 cm/6¾"

Hohlmeisselzangen
 Bone Rongeurs
 Pinzas-gubias
 Pincès-gouges
 Pinze-sgorbie

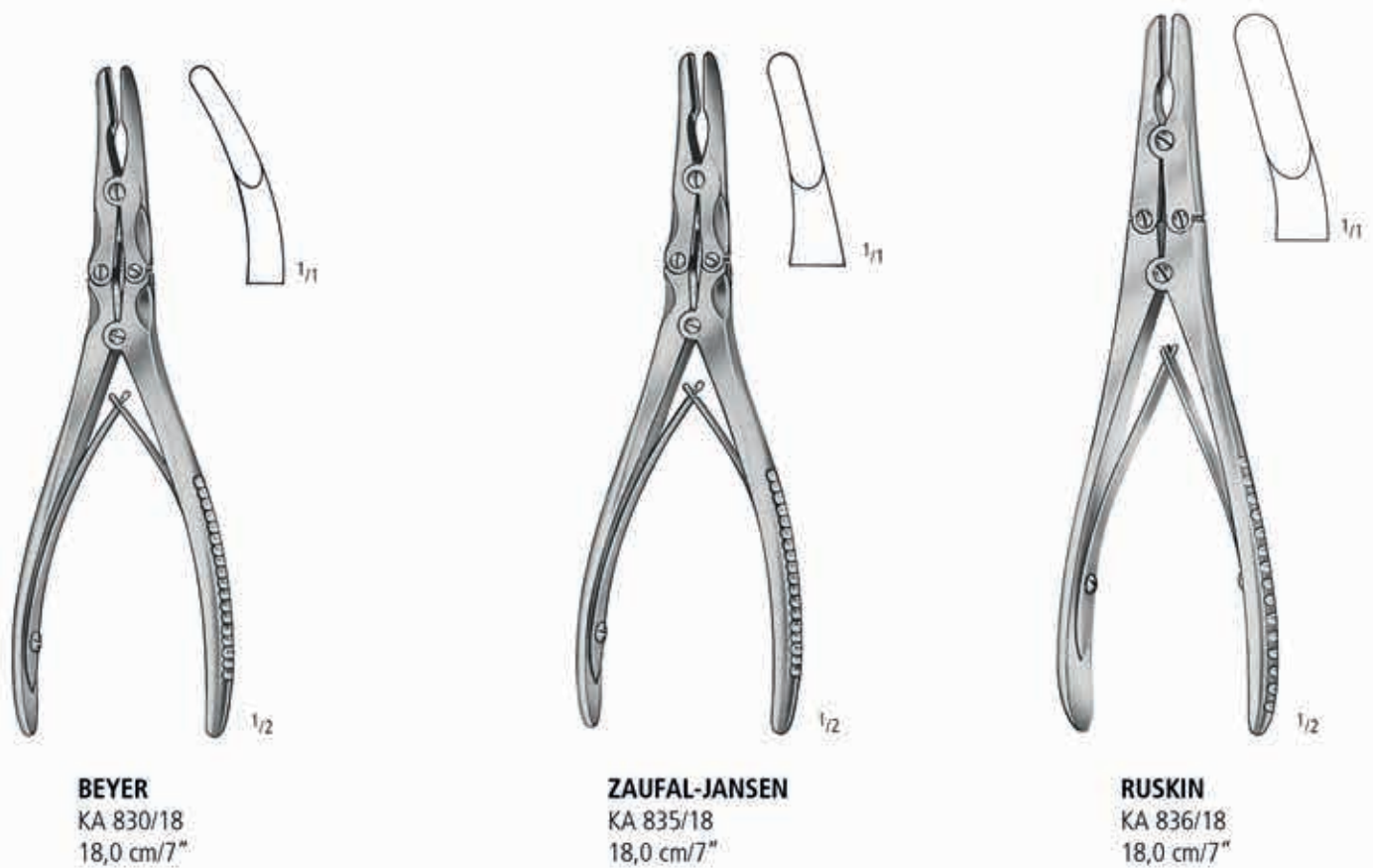
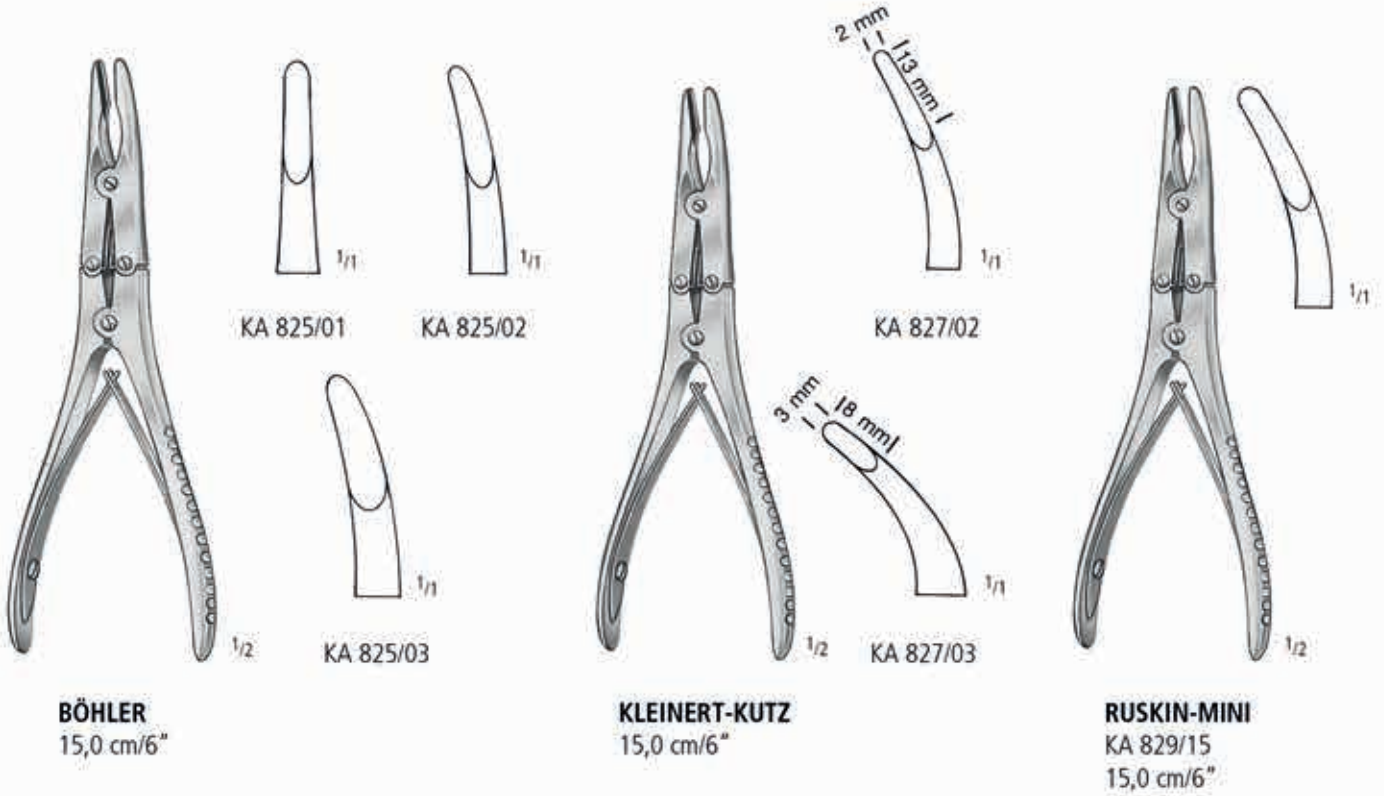

AA
 AB
 AC
 AE
 AK
 AO
 AR
 KA

K5
 XR
 XT

Hohlmeisselzangen
 Bone Rongeurs
 Pinzas-gubias
 Pincis-gouges
 Pinze-sgorbie

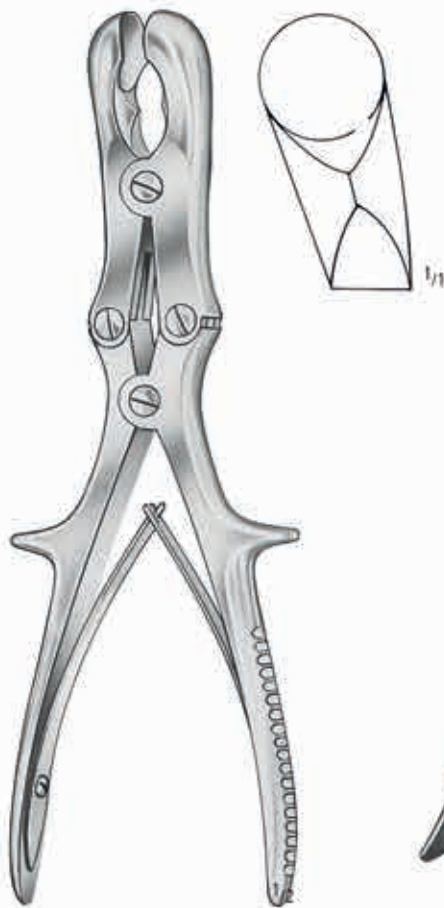

SEMB
 KA 838/22
 22,5 cm/9"



STILLE
 KA 840/23
 23,0 cm/9"



STILLE-RUSKIN
 KA 841/23
 23,0 cm/9"

Hohlmeisselzangen
 Bone Rongeurs
 Pinzas-gubias
 Pincès-gouges
 Pinze-sgorbie

AA

AB

AC

AE

AK

AO

AR

KA

KS

XR

XT

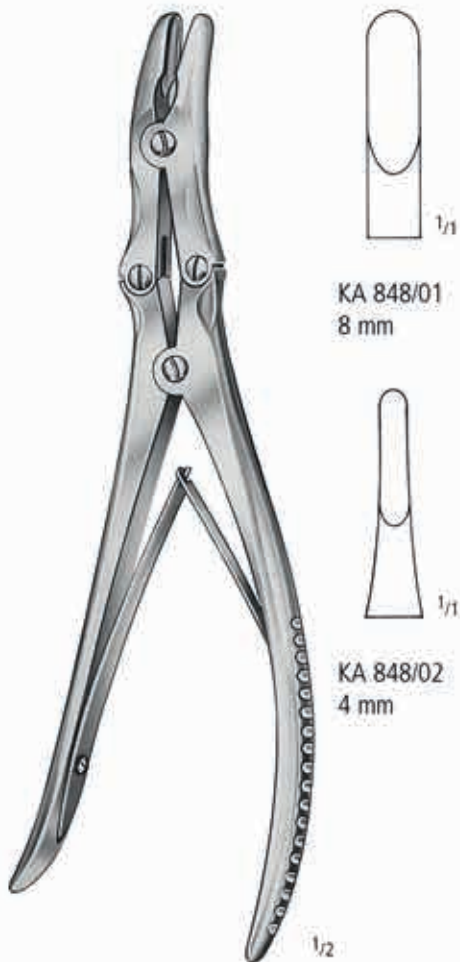

KA 848/01
8 mm

KA 848/02
4 mm

LEKSELL-STILLE
24,0 cm/9½"



FRYKHOLM
KA 859/23
23,0 cm/9"

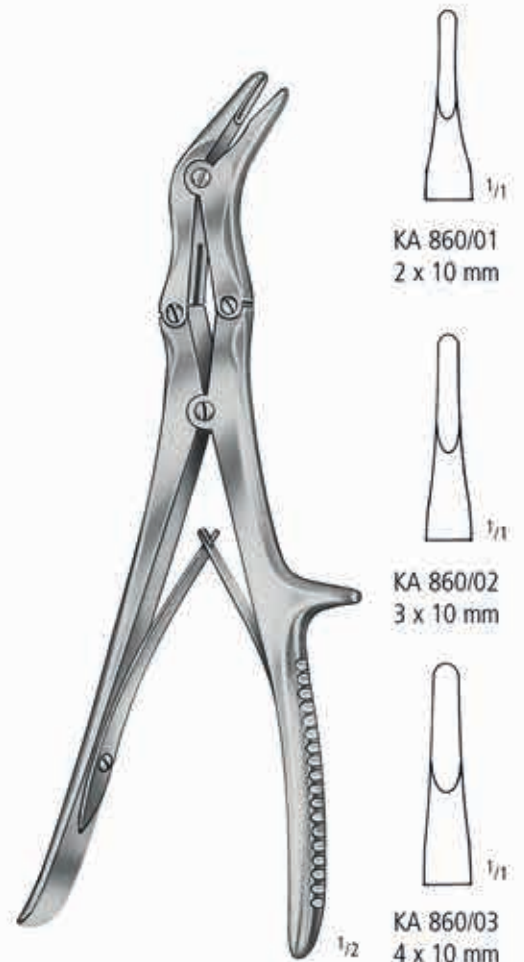

KA 860/01
2 x 10 mm

KA 860/02
3 x 10 mm

KA 860/03
4 x 10 mm

ECHLIN
23,0 cm/9"

Hohlmeisselzangen
 Bone Rongeurs
 Pinzas-gubias
 Pincès-gouges
 Pinze-sgorbie



RUSKIN
 KA 862/23
 23,0 cm/9"



SMITH-PETERSON
 24,0 cm/9 1/2"



3,0 mm
 KA 863/03



4,0 mm
 KA 863/04



5,0 mm
 KA 863/05



3,0 mm
 KA 863/13



4,0 mm
 KA 863/14

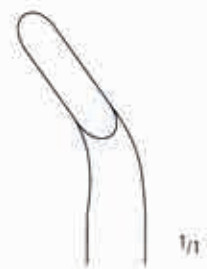

5,0 mm
 KA 863/15

AA

AB

AC

AE

AK

AO

AR

KA

KS

XR

XT

NEUROCHIRURGIE
NEUROSURGERY
NEUROCIRUGIA
NEUROCHIRURGIE
NEUROCHIRURGIA

KS

nopa[®] instruments



Feine Arterienklemmen
Fine Artery Forceps
Pinzas hemostáticas finas
Pincas hémostatiques fines
Pinze emostatiche fine

AA

AB

AC

AE

AK

AO

AB

KA

KS

XR

XT



HOEN
KS 001/13
13,5 cm/5 $\frac{1}{4}$ "



RAIMONDI
KS 003/13
12,5 cm/5"

Präparierklemmen
 Dissecting Forceps
 Pinzas para preparaciones
 Pincers à dissection
 Pinze per preparazione



KS 011/01
 19,5 cm/8"



KS 011/02
 19,5 cm/8"

Mikro-Instrumente
 Micro Instruments
 Instrumentos para microcirugia
 Instruments pour la chirurgie micro
 Strumenti per la chirurgia micro



18,5 cm/7 1/4"



KS 014/01



KS 014/02

AA

AB

AC

AE

AK

AO

AB

KA

KS

XR

XT

Mikro-Pinzetten
 Micro Forceps
 Micro-Pinzas
 Micro-Pinces
 Micro-Pinze



L	TIP	
18,0 cm/7"	0,6 mm	KS 020/06
18,0 cm/7"	0,9 mm	KS 020/09
18,0 cm/7"	1 : 2	KS 020/20
20,0 cm/8"	0,6 mm	KS 022/06
20,0 cm/8"	0,9 mm	KS 022/09
22,0 cm/8 ³ / ₄ "	0,6 mm	KS 024/06
22,0 cm/8 ³ / ₄ "	0,9 mm	KS 024/09
24,0 cm/9 ¹ / ₂ "	0,6 mm	KS 026/06
24,0 cm/9 ¹ / ₂ "	0,9 mm	KS 026/09

Mikro-Pinzetten, Nahtpinzetten
 Micro Forceps, Suture Forceps
 Micro-Pinzas, Pinzas para sutura
 Micro-Pinces, Pinces pour sutures
 Micro-Pinze, Pinze per sutura

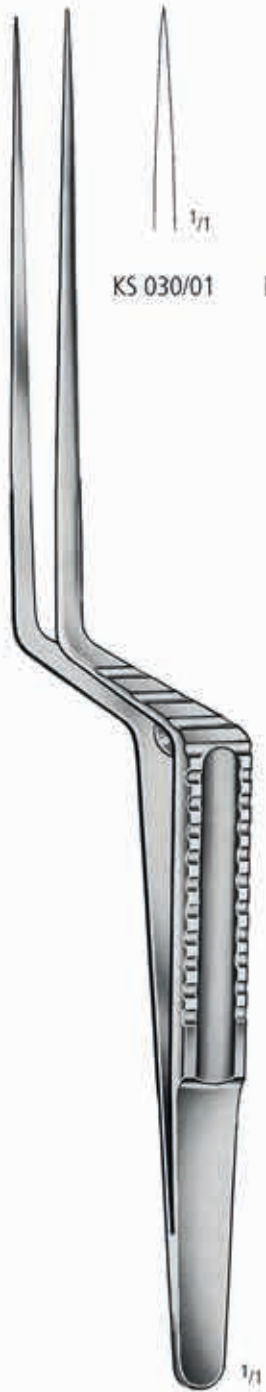
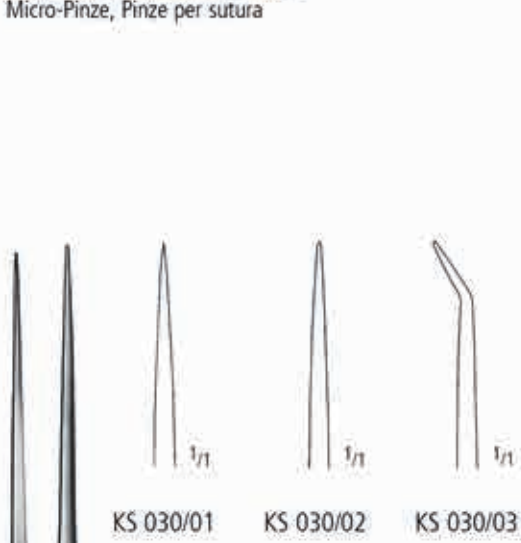

18,5 cm/7¹/₄"



KS 032/22
 22,0 cm/8³/₄"



KS 036/18
 18,5 cm/7¹/₄"

AA
 AB
 AC
 AE
 AK
 AO
 AR
 KA
 KR
 XT

KS

Mikro-Pinzetten
Micro Forceps
Micro-Pinzas
Micro-Pinces
Micro-Pinze

TITANIUM



DIETRICH

1,5 mm



2,0 mm



2,8 mm



15,0 cm/6"

KS 040/15

KS 040/20

KS 040/28

20,0 cm/8"

KS 041/15

KS 041/20

KS 041/28

24,0 cm/9³/₄"

KS 042/15

KS 042/20

KS 042/28

Mikroscheren
 Micro Scissors
 Micro Tijeras
 Micro Ciseaux
 Micro Forbici



20,0 cm/8"

45°



NAGEL
 KS 050/20

45°



KS 051/20

125°



KS 052/20

AA

AB

AC

AE

AK

AO

AB

KA

KS

XR

XT

Mikroscheren
Micro Scissors
Micro Tijeras
Micro Ciseaux
Micro Forbici

gezahnt
saw edge
dentadas
dentelés
dentata



16,0 cm/6¹/₄"

KS 060/16
gerade
straight
rectas
droits
retta

KS 061/16
gebogen
curved
curvas
courbes
curva



VANNAS
16,0 cm/6¹/₄"

KS 062/16
gerade
straight
rectas
droits
retta

KS 063/16
gebogen
curved
curvas
courbes
curva



MILLESİ
16,0 cm/6¹/₄"

KS 064/16
gerade
straight
rectas
droits
retta

KS 065/16
gebogen
curved
curvas
courbes
curva

Mikroscheren
Micro Scissors
Micro Tijeras
Micro Ciseaux
Micro Forbici



KS 068/00
18,5 cm/7¹/₄"



KS 069/19
19,0 cm/7¹/₂"

AA

AB

AC

AE

AK

AO

AB

KA

KS

XR

XT

Mikro-Nadelhalter mit Rundgriff
 Micro-Needle Holders with pen-type handle
 Micro-porta-agujas con mango redondo
 Micro-porte-aiguilles à manches rondes
 Micro-portaghi con manici rotondi



BARRAQUER



Tip 0,3 mm

Tip 0,3 mm

14,0 cm/5 1/2"
 18,0 cm/7"

KS 070/14
 KS 070/18

KS 071/14
 KS 071/18

Tip 0,8 mm

Tip 0,8 mm

14,0 cm/5 1/2"
 18,0 cm/7"

KS 072/14
 KS 072/18

KS 073/14
 KS 073/18



BARRAQUER



Tip 0,3 mm

Tip 0,3 mm

14,0 cm/5 1/2"
 18,0 cm/7"

KS 074/14
 KS 074/18

KS 075/14
 KS 075/18

Tip 0,8 mm

Tip 0,8 mm

14,0 cm/5 1/2"
 18,0 cm/7"

KS 076/14
 KS 076/18

KS 077/14
 KS 077/18

Nadelhalter
Needle Holders
Porta-agujas
Porte-aiguilles
Portaghi

nopa® DIAMOND



14,0 cm/5 1/2"

KS 080/14



18,0 cm/7"
23,0 cm/9"

KS 080/18
KS 080/23



14,0 cm/5 1/2"

KS 081/14



18,0 cm/7"
23,0 cm/9"

KS 081/18
KS 081/23



AA

AB

AC

AE

AK

AO

AR

KA

KS

XR

XT

Nadelhalter
Needle Holders
Porta-agujas
Porte-aiguilles
Portaghi

nopa[®] **DIAMOND**



KS 082/21



KS 083/21

1/11

21,0 cm/8 1/4"

Nadelhalter
Needle Holders
Porta-agujas
Porte-aiguilles
Portaghi

nopa® DIAMOND



15,0 cm/6"
18,0 cm/7"
23,0 cm/9"

KS 084/15
KS 084/18
KS 084/23

AA
AB
AC
AE
AK
AO
AB
KA
KS
XR
XT

Instrumente zur Schädelöffnung
 Instruments for Cranial Opening
 Instrumentos para abertura craneana
 Instruments pour l'ouverture du crâne
 Strumenti per l'apertura del cranio



L	2x	3x
30,0 cm/12"	KS 102/30	KS 103/30
40,0 cm/16"	KS 102/40	KS 103/40
50,0 cm/20"	KS 102/50	KS 103/50
60,0 cm/24"	KS 102/60	KS 103/60
70,0 cm/28"	KS 102/70	KS 103/70

OLIVECRONA-GIGLI



KS 120/00
 Paar / pair / pareja / paire / paio



KS 122/00
 Paar / pair / pareja / paire / paio



MARTEL
 KS 130/33
 33,0 cm/13"

Instrumente zur Schädelöffnung
 Instruments for Cranial Opening
 Instrumentos para abertura craneana
 Instruments pour l'ouverture du crâne
 Strumenti per l'apertura del cranio

AA

AB

AC

AE

AK

AO

AB

KA

KS

XR

XT



DE VILBISS
 KS 160/21
 21,0 cm/8¹/₄"



DAHLGREEN
 KS 162/20
 20,0 cm/8"

Schädelhalter
 Cervical Traction Tongs
 Pinzas de tracción craneal
 Pinces de traction crânienne
 Pinze per trazione craniale



CRUTCHFIELD
 KS 200/01



CRUTCHFIELD
 KS 200/02



KS 201/04
 Ø 3,5 mm



KS 201/05
 Ø 5,0 mm



KS 210/00



KS 210/01

Ersatzdorn
 Spare Pin
 Punta de repuesto
 Pointe de rechange
 Punta da scorta

Hirnretraktor
Brain Retractor
Separadores cerebrales
Ecarteurs cérébrales
Divaricatori cerebrali

AA

AB

AC

AE

AK

AO

AB

KA

KS

XR

XT

LEYLA



KS 220/01 = 1 x KS 220/10
+ 1 x KS 220/21
+ 1 x KS 220/45

LEYLA - 1
KS 220/01



KS 220/02 = 2 x KS 220/10
+ 1 x KS 220/22
+ 2 x KS 220/45

LEYLA - 2
KS 220/02

Hirnretraktor
Brain Retractor
Separadores cerebrales
Ecarteurs cérébrales
Divaricatori cerebrali

LEYLA



KS 220/10



KS 220/21



KS 220/22



KS 220/30



KS 220/40



KS 220/45

Hirnretraktor
Brain Retractor
Separadores cerebrales
Ecarteurs cérébrales
Divaricatori cerebrali

LEYLA

Satz
Set
KS 222/00 = 1 x KS 222/10
+ 1 x KS 222/20
+ 1 x KS 222/25



9 x 32 mm KS 222/09
10 x 25 mm KS 222/10



KS 222/20



KS 222/25



KS 222/40

AA
AB
AC
AE
AK
AO
AB
KA
KS
XR
XT

Hirnspatel
Brain Spatulas
Espátulas cerebrales
Spatules cérébrales
Spatoli cerebrali



biegsam
malleable
maleables
malléables
malleabile

8 mm	KS 230/08
11 mm	KS 230/11
14 mm	KS 230/14
17 mm	KS 230/17
20 mm	KS 230/20

HEIFETZ
20,0 cm/8"

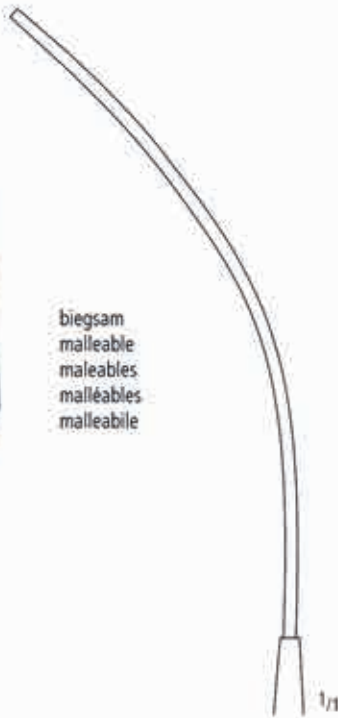

konkav
concave
cóncavas
concaves
concave

konvex
convex
convexas
convexes
convesses

	A mm	B mm	
KS 232/01	7	9	KS 233/01
KS 232/02	11	13	KS 233/02
KS 232/03	15	18	KS 233/03
KS 232/04	18	22	KS 233/04

OLIVECRONA
18,0 cm/7"



biegsam
malleable
maleables
malléables
malleabile

A mm	B mm	
7	9	KS 236/01
11	13	KS 236/02
15	18	KS 236/03
18	22	KS 236/04

B
18,0 cm/7"

biegsam
malleable
maleables
malléables
malleabile





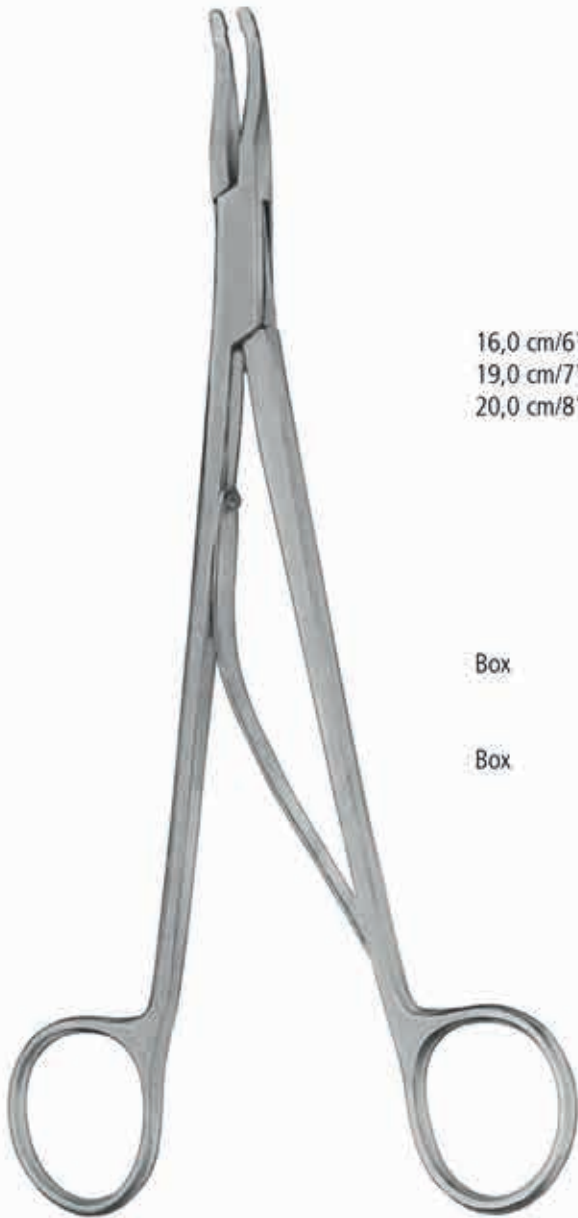

1/2
20,0 cm/8"

12 mm	KS 237/12
17 mm	KS 237/17

Anlegezangen, Clips
 Applying Forceps, Clips
 Pinzas aplicadoras, Clips
 Pincès pour le cuir chevelu, Clips
 Pinze al cuoio capelluto, Clips



	klein small	mittel medium	mittel-groß medium-large	groß large
	16,0 cm/6 1/4" 19,0 cm/7 1/2" 20,0 cm/8"	KS 240/01 KS 242/01	KS 240/02 KS 242/02	KS 241/01 KS 242/03
				
Box	12 x 25 clips KS 244/01	10 x 25 clips KS 245/01	16 x 10 clips KS 246/01	10 x 15 clips KS 247/01
Box	24 x 10 clips KS 244/02	20 x 10 clips KS 245/02		12 X 10 clips KS 247/02

AA
AB
AC
AE
AK
AO
AR
KA
KS
XR
XT

Anlegezangen
 Applying Forceps
 Pinzas aplicadoras
 Pincès pour le cuir chevelu
 Pinze al cuoio capelluto

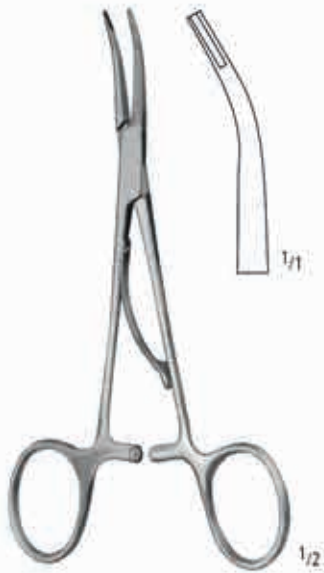

MC KENZIE

15,0 cm/6" KS 250/15
 19,0 cm/7½" KS 250/19

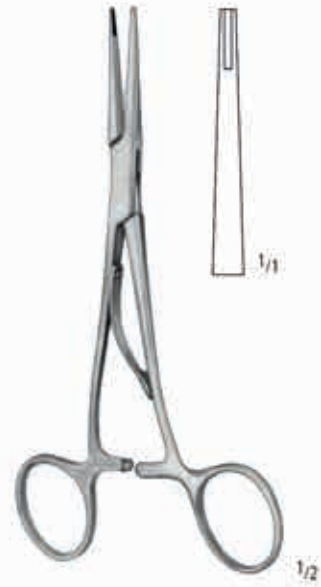

MC KENZIE

15,0 cm/6" KS 255/15
 19,0 cm/7½" KS 255/19

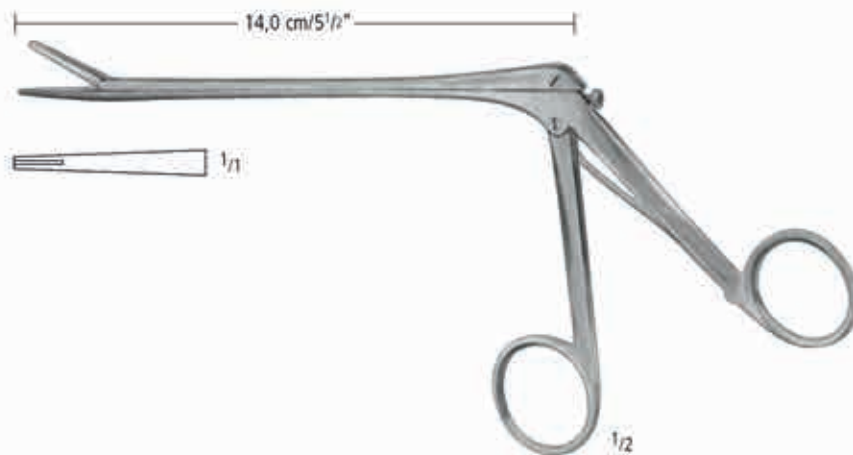

**OLIVECRONA-TOENNIS
 (SCOVILLE)**
 KS 258/00

Klammern und Anlegezangen
 Clips and Applying Forceps
 Grapas y pinzas aplicadoras
 Clips et pincés pour le cuir chevelu
 Agrafes e pinze al cuoio capelluto

AA

AB

AC

AE

AK

AO

AB

KA

KS

XR

XT



MC KENZIE
 148 x 40 x 6 mm
 KS 275/01



MC KENZIE
 190 x 48 x 13 mm
 KS 275/02

Verkaufseinheit: 100 Stück
 Unit for Sale: 100 pieces
 Unidad de venta: 100 piezas
 Unité de vente: 100 pièces
 Unità di vendita: 100 pezzi



KS 277/00

Verkaufseinheit: 10 Stück
 Unit for Sale: 10 pieces
 Unidad de venta: 10 piezas
 Unité de vente: 10 pièces
 Unità di vendita: 10 pezzi



KÖLNER
 KS 282/00



RANEY
 KS 286/00
 16,0 cm/6 1/4"



RANEY
 KS 288/00

Galeahaken
 Galea Hooks
 Gancho para Galea
 Crochets à Galea
 Uncini per Galea



Aneurysmen- und Gefäßclips
 Aneurysm- and Vessel Clips
 Clips de Aneurisma
 Clips pour Aneurisme
 Clips per Aneurismi

Also available in
TITANIUM

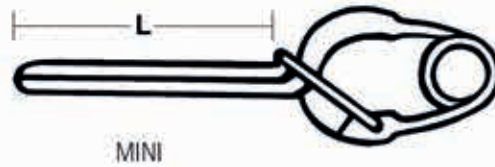

B
 Maulöffnung
 Opening
 Abertura
 Overture
 Apertura

F
 Schließkraft
 Closing Force
 Presión
 Pression
 Pressione

Permanent	KS 300/01	KS 302/01	KS 304/01	KS 306/01	KS 308/01
Temporary	KS 300/02	KS 302/02			KS 308/02

Permanent	KS 301/01	KS 303/01	KS 305/01	KS 307/01	KS 309/01
Temporary		KS 303/02		KS 307/02	

Permanent	KS 311/01	KS 313/01	KS 315/01	KS 317/01	KS 319/01
Temporary		KS 313/02			

	L (mm)	B (mm)	F (g)
KS 300/01	3,0	3,3	110
KS 300/02	3,0	3,3	50
KS 301/01	3,0	3,2	110
KS 302/01	5,0	4,0	110
KS 302/02	5,0	4,0	50
KS 303/01	5,0	3,8	110
KS 303/02	5,0	3,8	50
KS 304/01	3,0	3,3	110
KS 305/01	5,0	3,8	110
KS 306/01	5,0	4,0	110
KS 307/01	7,0	4,4	110

Also available in
TITANIUM

	L (mm)	B (mm)	F (g)
KS 307/02	7,0	4,4	70
KS 308/01	7,0	4,6	110
KS 308/02	7,0	4,6	70
KS 309/01	5,0	3,6	110
KS 311/01	5,0	3,5	110
KS 313/01	7,0	4,0	110
KS 313/02	7,0	4,0	70
KS 315/01	5,0	3,5	130
KS 317/01	7,0	5,7	130
KS 319/01	7,0	4,5	130

Aneurysmen- und Gefäßclips
 Aneurysm- and Vessel Clips
 Clips de Aneurisma
 Clips pour Aneurisme
 Clips per Aneurismi

Also available in
TITANIUM

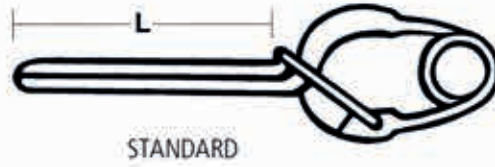

B
 Maulöffnung
 Opening
 Abertura
 Overture
 Apertura

F
 Schließkraft
 Closing Force
 Presión
 Pression
 Pressione

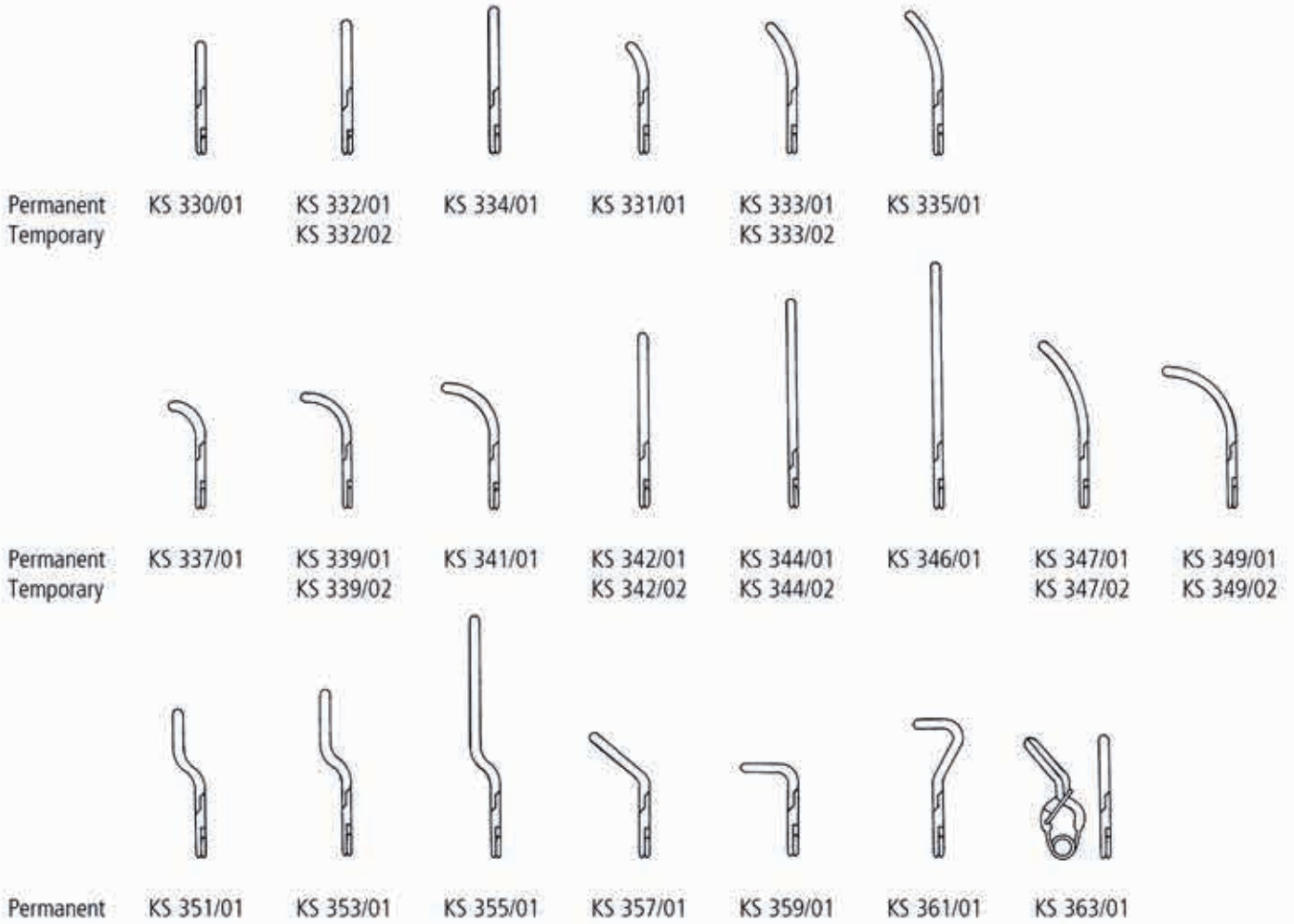

	L (mm)	B (mm)	F (g)		L (mm)	B (mm)	F (g)
KS 330/01	7,0	6,2	150	KS 344/01	20,0	11,4	200
KS 331/01	7,0	6,0	150	KS 344/02	20,0	11,4	90
KS 332/01	9,0	7,0	180	KS 346/01	25,0	13,3	180
KS 332/02	9,0	7,0	70	KS 347/01	15,0	8,7	200
KS 333/01	9,0	6,8	180	KS 347/02	15,0	8,7	70
KS 333/02	9,0	6,8	70	KS 349/01	15,0	7,4	200
KS 334/01	11,0	7,8	180	KS 349/02	15,0	7,4	70
KS 335/01	11,0	7,5	180	KS 351/01	7,0	7,9	200
KS 337/01	7,0	5,5	150	KS 353/01	9,0	8,7	200
KS 339/01	9,0	6,1	180	KS 355/01	20,0	13,0	180
KS 339/02	9,0	6,1	70	KS 357/01	9,0	6,5	200
KS 341/01	11,0	6,5	180	KS 359/01	7,0	4,5	200
KS 342/01	15,0	9,2	200	KS 361/01	7,0	7,2	200
KS 342/02	15,0	9,2	70	KS 363/01	7,0	5,7	200

Also available in
TITANIUM

NEUROCHIRURGIE NEUROSURGERY NEUROCIRUGIA NEUROCHIRURGIE NEUROCHIRURGIA

Aneurysmen- und Gefäßclips
Aneurysm- and Vessel Clips
Clips de Aneurisma
Clips pour Aneurisme
Clips per Aneurismi

Also available in
TITANIUM

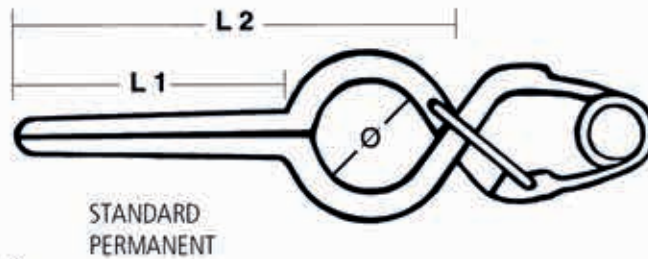

B Maulöffnung
Opening
Abertura
Overture
Apertura

F Schließkraft
Closing Force
Presión
Pression
Pressione

Ø 3,5 mm



KS 370/01

KS 370/02

KS 370/03

KS 371/01

KS 371/02

KS 371/03

KS 372/01

KS 372/02

KS 372/03

Ø 5,0 mm



KS 374/01

KS 374/02

KS 374/03

KS 375/01

KS 375/02

KS 375/03

Also available in
TITANIUM

Ø 5,0 mm



KS 376/01

KS 376/02

KS 376/03

KS 377/01

KS 377/02

KS 377/03

	L1/L2 (mm)	B (mm)	F (g)
KS 370/01	6,0/11,0	7,4	150
KS 370/02	9,0/14,0	8,4	150
KS 370/03	12,0/17,0	9,6	180
KS 371/01	5,0/ 9,0	5,8	150
KS 371/02	7,5/11,5	6,5	150
KS 371/03	10,0/14,0	7,2	180
KS 372/01	5,0/ 9,6	4,9	150
KS 372/02	7,5/12,1	4,9	150
KS 372/03	10,0/14,6	4,9	180
KS 374/01	6,0/12,7	7,9	150
KS 374/02	9,0/15,7	9,1	150
KS 374/03	12,0/18,7	10,3	180

Also available in
TITANIUM

	L1/L2 (mm)	B (mm)	F (g)
KS 375/01	5,0/10,5	6,5	150
KS 375/02	7,5/13,0	7,2	150
KS 375/03	10,0/15,5	7,8	180
KS 376/01	5,0/11,0	5,5	150
KS 376/02	7,5/13,5	5,5	150
KS 376/03	10,0/16,0	5,5	180
KS 377/01	5,0/14,8	7,9	150
KS 377/02	7,5/17,3	8,8	150
KS 377/03	10,0/19,8	10,0	180

AA
AB
AC
AE
AK
AO
AR
KA
KS
XR
XT

Anlegezangen für Aneurysmen-Clips
 Applying Forceps for Aneurysm Clips
 Pinza para juntar clips de Aneurisma
 Pince pour poser les clips de Aneurisme
 Pinze per applicare clips Aneurismi



18,0 cm/7"



17,0 cm/6³/₄"



20,5 cm/8"



22,5 cm/9"

MINI
 STANDARD

KS 390/01
 KS 390/02

KS 391/01
 KS 391/02

KS 392/01
 KS 392/02

KS 393/01
 KS 393/02

Anlegezangen für Aneurysmen-Clips
 Applying Forceps for Aneurysm Clips
 Pinza para juntar clips de Aneurisma
 Pince pour poser les clips de Aneurisme
 Pinze per applicare clips Aneurismi

FLEXIBLE

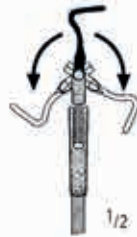

Beispiel für Drehmechanismus
 Example for rotation
 Ejemplo para la rotación
 Exemple pour la rotation
 Esempio per la rotazione



Schaft drehbar
 Shank rotatable
 Vaina giratoria
 Tige rotative
 Asta girevole



	MINI	STANDARD	MINI	STANDARD
70mm/2 ³ / ₄ "	KS 396/11	KS 396/21	KS 397/11	KS 397/21
90mm/3 ¹ / ₂ "	KS 396/12	KS 396/22	KS 397/12	KS 397/22
110mm/4 ¹ / ₄ "	KS 396/13	KS 396/23	KS 397/13	KS 397/23
130mm/5"	KS 396/14	KS 396/24	KS 397/14	KS 397/24

nicht drehbar
 non rotating
 non rotatif
 non rotativo
 non rotatorio

drehbar
 rotating
 rotatif
 rotativo
 rotatorio

AA
AB
AC
AE
AK
AO
AB
KA
KS
XR
XT

Muskelspreizer
 Dissectomy Retractors
 Separadores para músculos
 Ecarteurs musculaire
 Divaricatori muscolari



KS 520/01



1/1

20 x 50 mm

20 x 60 mm

20 x 70 mm

KS 520/50

KS 520/60

KS 520/70

KS 520/51

KS 520/61

KS 520/71

- HEY**
 KS 520/00 = 1 x KS 520/01
 + 1 x KS 520/50
 + 1 x KS 520/60
 + 1 x KS 520/70
 + 1 x KS 520/37
 + 1 x KS 520/53
 + 1 x KS 520/62



1/1

KS 520/37
 37 mm

KS 520/53
 53 mm

KS 520/62
 62 mm

Muskelspreizer
 Dissectomy Retractors
 Separadores para músculos
 Ecarteurs musculaire
 Divaricatori muscolari



KS 521/51 - KS 521/72
 17,0 cm/6³/₄"



KS 522/51 - KS 522/72
 17,0 cm/6³/₄"

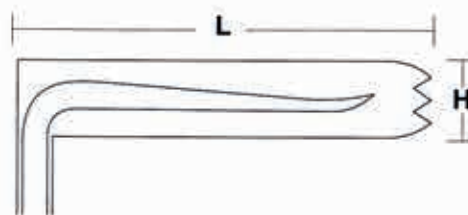

L	H	Linksmodell Left-type	Rechtsmodell Right-type
50 mm x 10 mm		KS 521/51	KS 522/51
60 mm x 10 mm		KS 521/61	KS 522/61
70 mm x 10 mm		KS 521/71	KS 522/71
50 mm x 20 mm		KS 521/52	KS 522/52
60 mm x 20 mm		KS 521/62	KS 522/62
70 mm x 20 mm		KS 521/72	KS 522/72

AA
 AB
 AC
 AE
 AK
 AO
 AR
 KA
 KR
 XT

KS

Wundspreizer Wirbelsäule
 Cervical Retractors
 Separadores vertebrales
 Ecarteurs cervicaux
 Divaricatori vertebrali

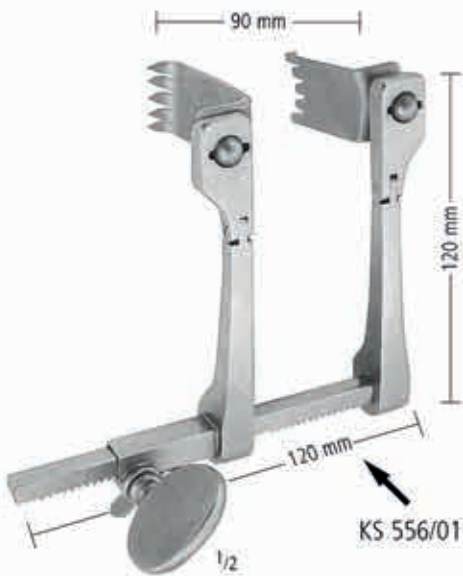

CASPAR
 KS 556/00
 Transversal



CASPAR
 KS 557/00



CASPAR
 KS 558/00

- KS 556/00 = 1 x KS 556/01
- + 1 x KS 559/01
- + 1 x KS 559/02
- + 1 x KS 559/03
- + 1 x KS 559/04
- + 1 x KS 559/05
- + 1 x KS 559/11
- + 1 x KS 559/12
- + 1 x KS 559/13
- + 1 x KS 559/14
- + 1 x KS 559/15

- KS 557/00 = 1 x KS 557/01
- + 1 x KS 559/21
- + 1 x KS 559/22
- + 1 x KS 559/23
- + 1 x KS 559/24
- + 1 x KS 559/25

- KS 558/00 = 1 x KS 558/01
- + 1 x KS 559/21
- + 1 x KS 559/22
- + 1 x KS 559/23
- + 1 x KS 559/24
- + 1 x KS 559/25

Wundspreizer Wirbelsäule
 Cervical Retractors
 Separadores vertebrales
 Ecarteurs cervicales
 Divaricatori vertebrali



- 40 x 23 mm KS 559/01
- 45 x 23 mm KS 559/02
- 50 x 23 mm KS 559/03
- 55 x 23 mm KS 559/04
- 60 x 23 mm KS 559/05



- 40 x 23 mm KS 559/11
- 45 x 23 mm KS 559/12
- 50 x 23 mm KS 559/13
- 55 x 23 mm KS 559/14
- 60 x 23 mm KS 559/15



- 45 x 23 mm KS 559/21
- 50 x 23 mm KS 559/22
- 55 x 23 mm KS 559/23
- 60 x 23 mm KS 559/24
- 65 x 23 mm KS 559/25



- 50 x 25 mm KS 559/50
- 60 x 25 mm KS 559/60



KS 564/00
 11,5 cm/4 1/2"

AA
 AB
 AC
 AE
 AK
 AO
 AR
 KA
 KR
 XT

KS

Wundspreizer Wirbelsäule
 Cervical Retractors
 Separadores vertebrales
 Ecarteurs cervicaux
 Divaricatori vertebrali

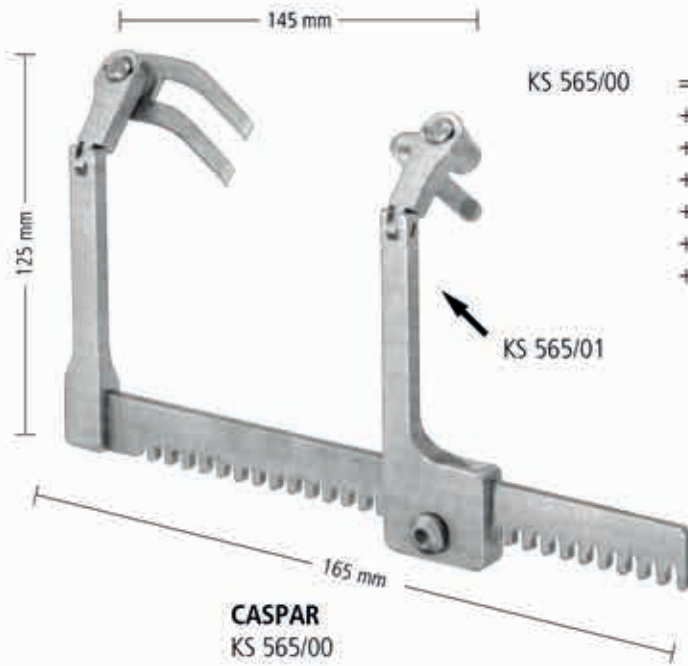

- KS 565/00 = 1 x KS 565/01
 + 1 x KS 565/99
 + 1 x KS 566/21
 + 1 x KS 566/22
 + 1 x KS 566/23
 + 1 x KS 566/24
 + 1 x KS 566/25



KS 565/99



38 mm
 KS 566/01



58 mm
 KS 566/02



L
 32 mm KS 566/20
 37 mm KS 566/21
 43 mm KS 566/22
 47 mm KS 566/23
 52 mm KS 566/24
 57 mm KS 566/25
 62 mm KS 566/26
 67 mm KS 566/27



KS 566/30
 KS 566/31
 KS 566/32
 KS 566/33
 KS 566/34
 KS 566/35
 KS 566/36
 KS 566/37



KS 566/40
 KS 566/41
 KS 566/42
 KS 566/43
 KS 566/44
 KS 566/45
 KS 566/46
 KS 566/47

Wundspreizer
Retractors
Separadores
Ecarteurs
Divaricatori

AA

AB

AC

AE

AK

AO

AB

KA

KS

XR

XT

Oberfläche geschwärzt
Surface black-finish



L	
40 mm	KS 568/40
45 mm	KS 568/45
50 mm	KS 568/50
55 mm	KS 568/55
60 mm	KS 568/60

CASPAR



L	
35 mm	KS 569/35
40 mm	KS 569/40
45 mm	KS 569/45
50 mm	KS 569/50
55 mm	KS 569/55
60 mm	KS 569/60

CASPAR

KS 569/00	=	1 x KS 569/01
	+	1 x KS 569/35
	+	1 x KS 569/40
	+	1 x KS 569/45
	+	1 x KS 569/50
	+	1 x KS 569/55
	+	1 x KS 569/60

Wundspreizer
Retractors
Separadores
Ecarteurs
Divaricatori

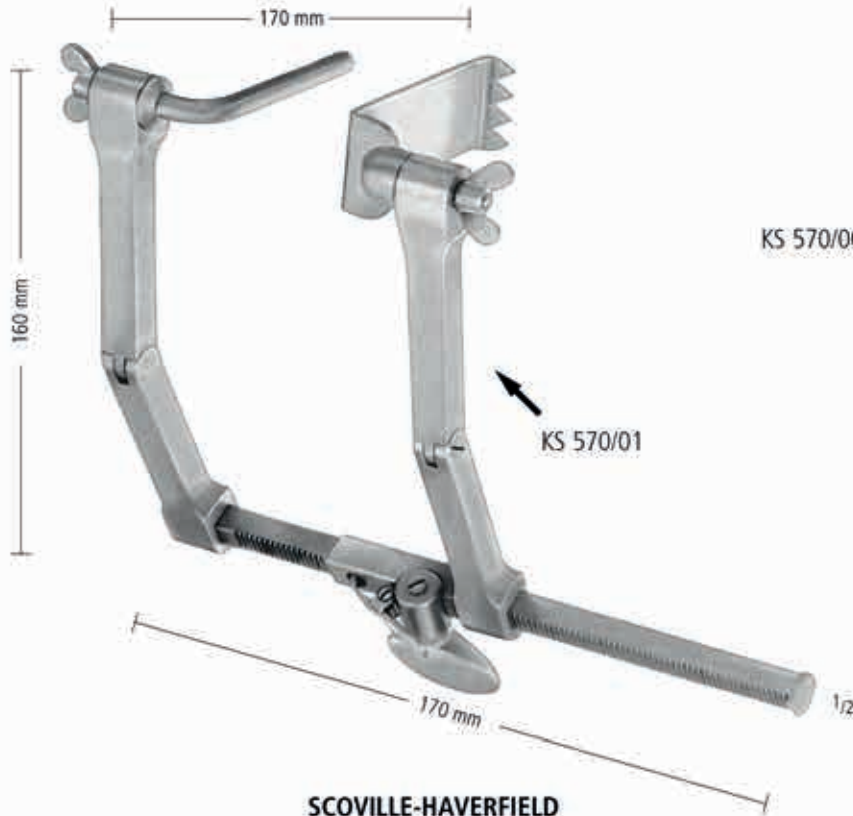

KS 570/00 = 1 x KS 570/01
+ 1 x KS 570/02
+ 1 x KS 570/10

SCOVILLE-HAVERFIELD
KS 570/00



SCOVILLE
KS 570/02
5,5 cm/2"



SCOVILLE
63 x 25 mm KS 570/10
63 x 51 mm KS 570/11
67 x 32 mm KS 570/12
89 x 25 mm KS 570/13



TAYLOR
47 X 37 mm KS 570/33



TAYLOR
63 X 51 mm KS 570/44

Wundspreizer
Retractors
Separadores
Ecarteurs
Divaricatori

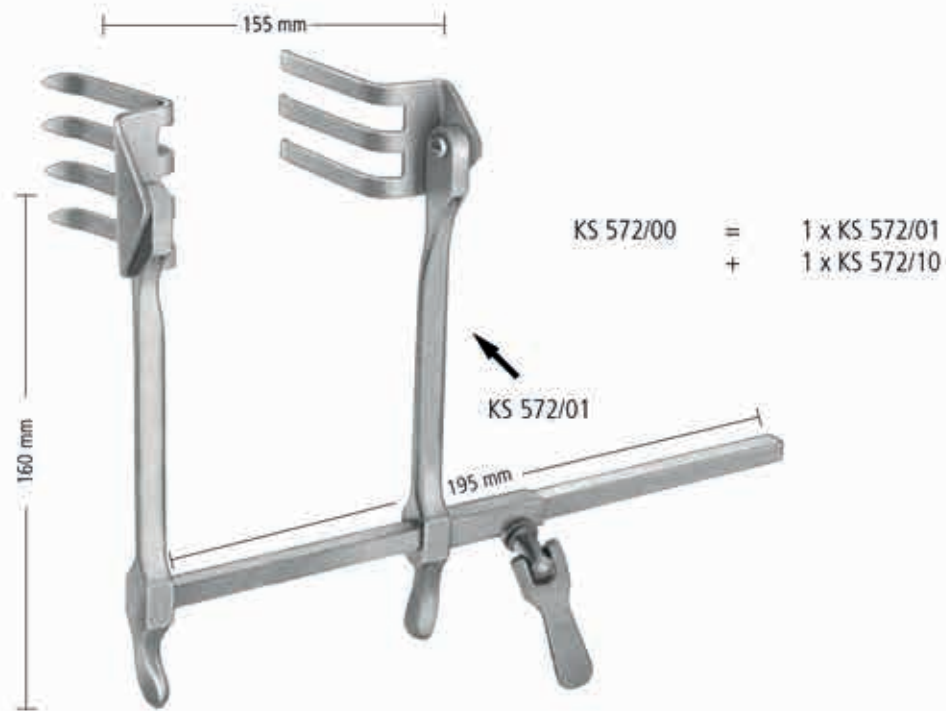

SCOVILLE-RICHTER
KS 572/00



KS 572/10 (Paar/Pair)
62 x 52 mm 62 x 37 mm



KS 572/20
47 x 51 mm



KS 572/30
30 x 40 mm



KS 572/40
37 x 62 mm

AA
AB
AC
AE
AK
AO
AR
KA
KS
XR
XT

Wundspreizer
 Retractors
 Separadores
 Ecarteurs
 Divaricatori



CLOWARD modif.
 KS 580/00
 25,0 cm/10"



- | | |
|----------|-----------|
| L | |
| 40 mm | KS 580/10 |
| 45 mm | KS 580/11 |
| 50 mm | KS 580/12 |
| 55 mm | KS 580/13 |
| 60 mm | KS 580/14 |



- | | |
|----------|-----------|
| L | |
| 40 mm | KS 580/20 |
| 45 mm | KS 580/21 |
| 50 mm | KS 580/22 |
| 55 mm | KS 580/23 |
| 60 mm | KS 580/24 |

- | | | |
|-----------|---|---------------|
| KS 580/00 | = | 1 x KS 580/01 |
| | + | 1 x KS 580/10 |
| | + | 1 x KS 580/11 |
| | + | 1 x KS 580/12 |
| | + | 1 x KS 580/13 |
| | + | 1 x KS 580/14 |

Wundspreizer
Retractors
Separadores
Ecarteurs
Divaricatori

AA

AB

AC

AE

AK

AO

AB

KA

KS

XR

XT



KS 582/00



L	Part Number
40 mm	KS 580/10
45 mm	KS 580/11
50 mm	KS 580/12
55 mm	KS 580/13
60 mm	KS 580/14



L	Part Number
40 mm	KS 580/20
45 mm	KS 580/21
50 mm	KS 580/22
55 mm	KS 580/23
60 mm	KS 580/24

KS 582/00	=	1 x KS 582/01
	+	1 x KS 580/10
	+	1 x KS 580/11
	+	1 x KS 580/12
	+	1 x KS 580/13
	+	1 x KS 580/14

Wirbelkörperspreizer
 Lamina Spreaders
 Separadores para cuerpos vertebrales
 Ecarteurs pour corps vertébraux
 Separatori per vertebre



CLOWARD
 KS 587/08
 T = 70 mm



CLOWARD
 KS 588/09 9,0 cm/3³/₄" KS 588/11 11,0 cm/4¹/₄"



CLOWARD
 KS 589/00
 21,0 cm/8¹/₄"

Wirbelkörperspreizer
 Lamina Spreaders
 Separadores para cuerpos vertebrales
 Ecarteurs pour corps vertébraux
 Separatori per vertebre

AA

AB

AC

AE

AK

AO

AB

KA

KS

XR

XT



HARMS
 KS 590/01
 18,0 cm/7"



HARMS
 KS 590/02
 18,0 cm/7"

Wirbelkörperspreizer
 Lamina Spreaders
 Separadores para cuerpos vertebrales
 Ecarteurs pour corps vertébraux
 Separatori per vertebre



CLOWARD
 KS 592/16
 16,0 cm/6¹/₂"

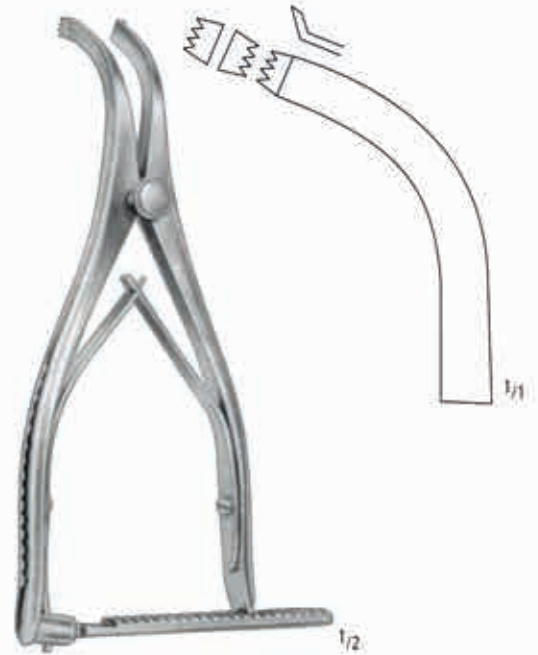

INGE
 KS 593/17
 16,5 cm/6¹/₂"

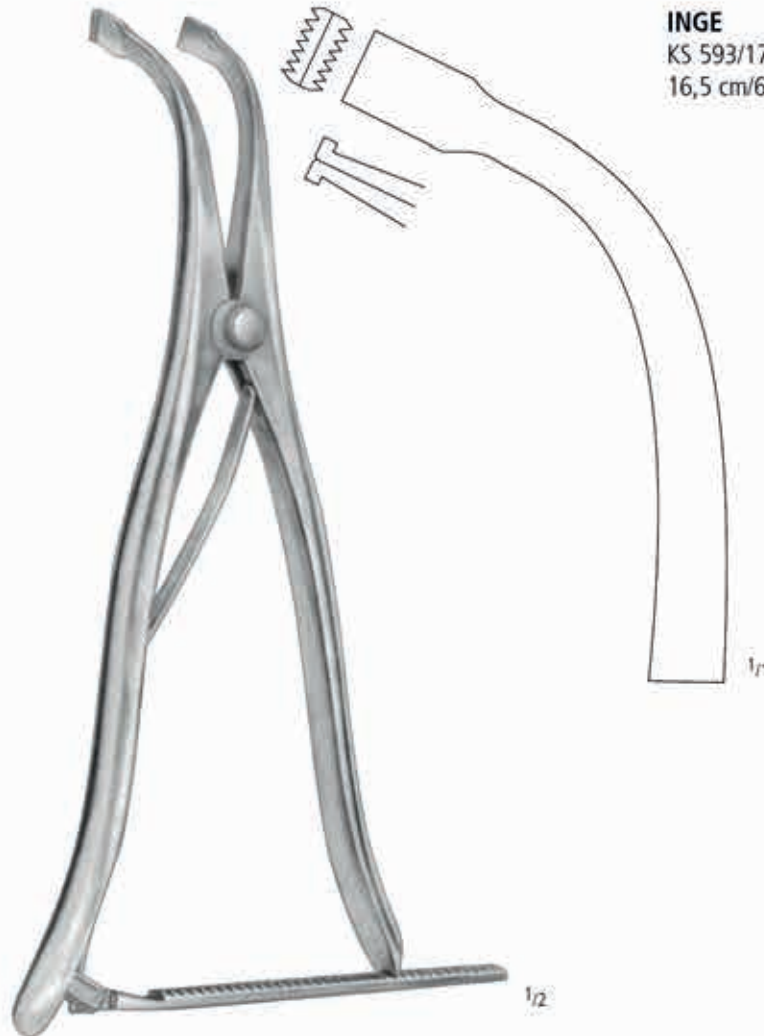

INGE
 KS 594/27
 27,0 cm/10³/₄"

Nervwurzelhaken
 Nerve Root Retractors
 Separadores de raíz de nervios
 Rétracteurs pour racines nerveuses
 Uncini per le radici dei nervi

AA

AB

AC

AE

AK

AO

AB

KA

KS

XR

XT



HORSLEY
 KS 607/20
 20,0 cm/8"



SACHS
 KS 608/21
 21,0 cm/8 1/2"



SCOVILLE
 KS 609/23
 23,0 cm/9 1/4"

Nervwurzelhaken
Nerve Root Retractors
Separadores de raíz de nervios
Rétracteurs pour racines nerveuses
Uncini per le radici dei nervi



LOVE

	45°	90°
KS 610/01	KS 610/02	KS 610/03
19,0 cm/7 1/2"	19,0 cm/7 1/2"	19,0 cm/7 1/2"



Tip
3 mm
5 mm
7 mm

	L	L
	7,0 cm/3"	10,0 cm/4"
	KS 610/11	KS 610/21
	KS 610/12	KS 610/22
	KS 610/13	KS 610/23

LOVE modif.

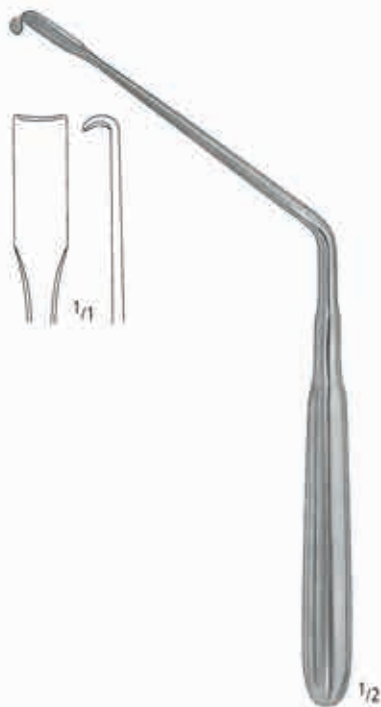

KS 611/20
20,0 cm/8"

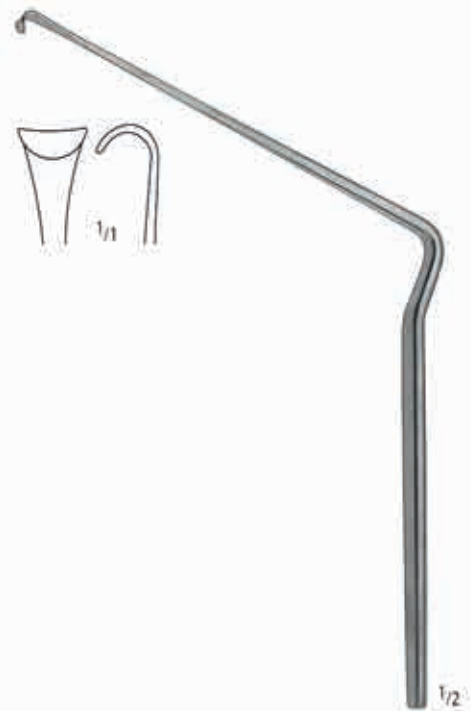

MARTIN
KS 612/21
21,0 cm/8 1/4"

Nervhaken
Nerve Hooks
Ganchos para nervios
Crochets à nerfs
Uncini per nervi

AA

AB

AC

AE

AK

AO

AR

KA

KS

XR

XT



KS 613/01

KS 613/02

GRONINGEN
26,0 cm/10¹/₄"

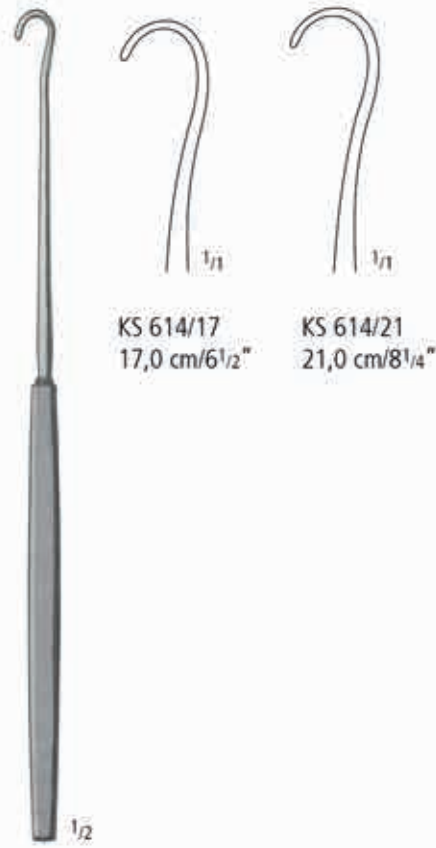

KS 614/17
17,0 cm/6¹/₂"

KS 614/21
21,0 cm/8¹/₄"

SMITHWICK



DANDY
KS 615/20
20,0 cm/8"

Nervhaken
Nerve Hooks
Ganchos para nervios
Crochets à nerfs
Uncini per nervi



KRAYENBÜHL
18,5 cm/7¹/₄"

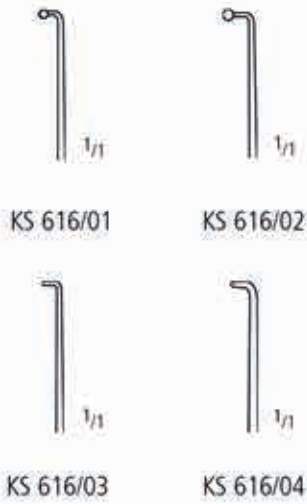

BIEMER
KS 617/16
16,0 cm/6¹/₄"



FISCH
18,5 cm/7¹/₄"

Durahaken
 Dura Hooks
 Ganchos para dura-madre
 Crochets à dure-mère
 Uncini per dura-madre

AA

AB

AC

AE

AK

AO

AR

KA

KS

XR

XT



CUSHING
 KS 620/14
 14,0 cm/5 1/2"



ADSON
 KS 621/20
 20,0 cm/8"



GRAHAM
 KS 622/16
 16,5 cm/6 1/2"

Dura Dissektoren
 Dura Dissectors
 Disecadores para dura-madre
 Dissecteurs à dure-mère
 Dissetori per dura-madre

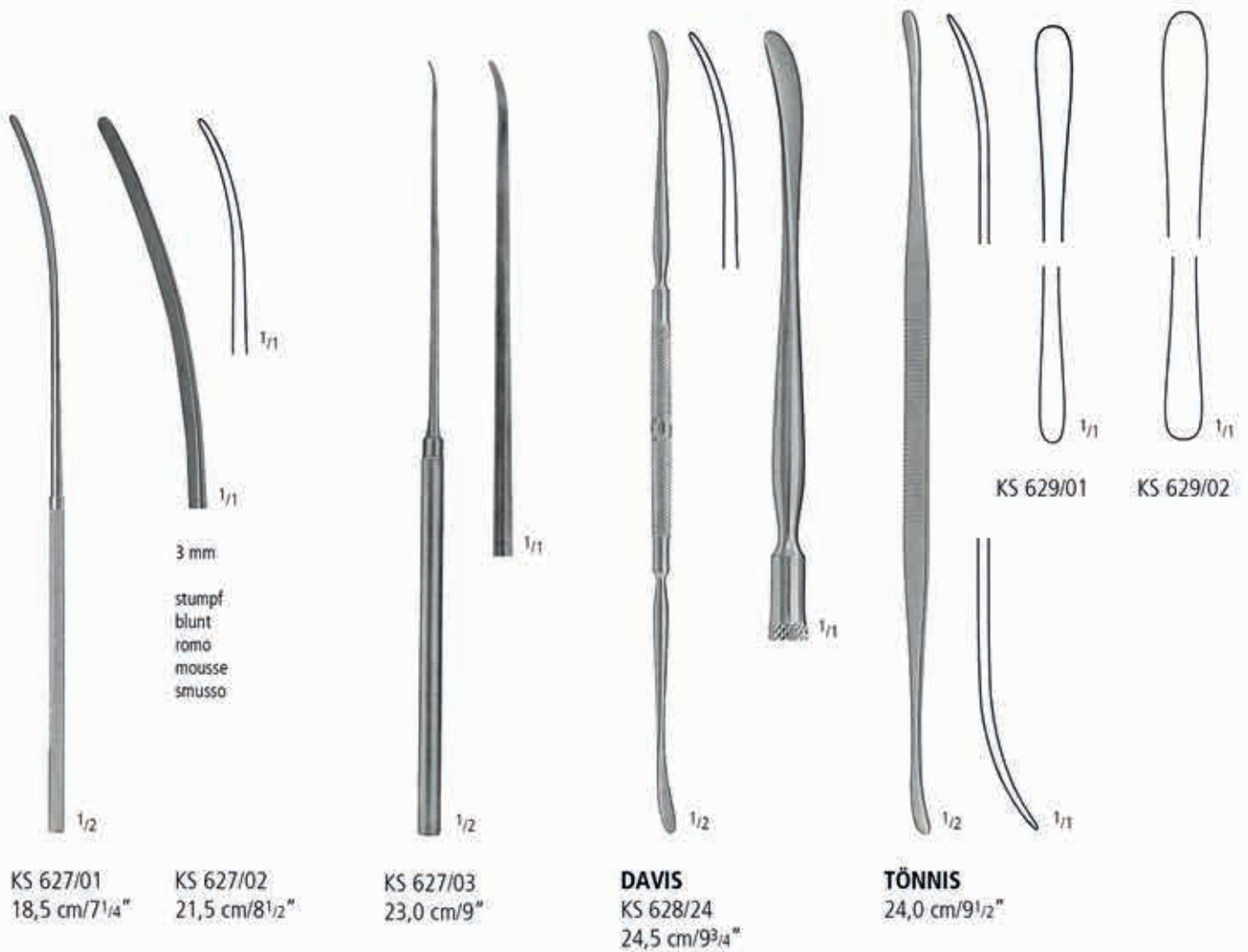

Dura Dissektoren
 Dura Dissectors
 Disecadores para dura-madre
 Dissecteurs à dure-mère
 Dissettori per dura-madre



SACHS
 KS 631/21
 21,0 cm/8¹/₄"



SACHS
 KS 632/21
 21,0 cm/8¹/₄"



FRAZIER
 KS 633/01
 15,0 cm/6"



HOEN
 KS 633/02
 15,0 cm/6"



HOEN
 KS 633/03
 15,0 cm/6"

AA
 AB
 AC
 AE
 AK
 AO
 AB
 KA
 KS
 XR
 XT

Dura Dissektoren
 Dura Dissectors
 Disecadores para dura-madre
 Dissecteurs à dure-mère
 Dissetori per dura-madre



KS 634/18
 18,0 cm/7"

KS 635/20
 19,5 cm/7³/₄"

KS 634/24
 24,0 cm/9¹/₂"

KS 635/24
 24,0 cm/9¹/₂"

¹/₂

OLIVECRONA



MILLIGAN
 KS 636/21
 21,0 cm/8¹/₄"

¹/₁₁

¹/₁₂

¹/₁₁



KS 637/22
 22,0 cm/8³/₄"

¹/₁₂

¹/₁₁

Dura Dissektoren
 Dura Dissectors
 Disecadores para dura-madre
 Dissecteurs à dure-mère
 Dissetori per dura-madre

AA

AB

AC

AE

AK

AO

AR

KA

KS

XR

XT



PENFIELD
 KS 638/01
 17,5 cm/7"



PENFIELD
 KS 638/02
 19,5 cm/7³/₄"



PENFIELD
 KS 638/03
 19,5 cm/7³/₄"



PENFIELD
 KS 638/04
 20,5 cm/8"



PENFIELD
 KS 638/05
 29,0 cm/11¹/₂"

Mikro-Instrumente
 Micro Instruments
 Instrumentos para microcirugia
 Instruments pour la chirurgie micro
 Strumenti per chirurgia micro



1/1 23,0 cm/9"



1/1 23,0 cm/9"

Mikro-Instrumente
 Micro Instruments
 Instrumentos para microcirugía
 Instruments pour la chirurgie micro
 Strumenti per chirurgia micro

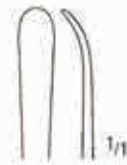

KS 642/01
 23,0 cm/9"



KS 642/02
 20,0 cm/8"

1/1 CASPAR

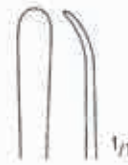

KS 642/03
 23,0 cm/9"



KS 642/05
 21,0 cm/8 1/4"

1/1 CASPAR



KS 642/04
 23,0 cm/9"



KS 642/06
 21,0 cm/8 1/4"

AA
 AB
 AC
 AE
 AK
 AO
 AR
 KA
 KR
 XT

KS

Mikro-Instrumente
 Micro Instruments
 Instrumentos para microcirugía
 Instruments pour la chirurgie micro
 Strumenti per chirurgia micro



KS 643/19
 18,5 cm/7¹/₄"



KS 643/22
 21,5 cm/8¹/₂"



1/1



1/1 CASPAR



KS 644/01
 24,5 cm/9³/₄"



KS 644/02
 24,5 cm/9³/₄"



KS 644/03
 24,5 cm/9³/₄"



KS 644/04
 24,5 cm/9³/₄"

Mikro-Instrumente
 Micro Instruments
 Instrumentos para microcirugía
 Instruments pour la chirurgie micro
 Strumenti per chirurgia micro

AA
 AB
 AC
 AE
 AK
 AO
 AB
 KA
 KS
 XR
 XT



1/1 SAMII



20,0 cm/8" KS 647/01
 23,0 cm/9 1/4" KS 648/01



KS 647/02
 KS 648/02



KS 647/03
 KS 648/03



KS 647/04
 KS 648/04



20,0 cm/8" KS 647/05
 23,0 cm/9 1/4" KS 648/05



KS 647/06
 KS 648/06



KS 647/07
 KS 648/07



KS 647/08
 KS 648/08

Mikro-Instrumente
 Micro Instruments
 Instrumentos para microcirugia
 Instruments pour la chirurgie micro
 Strumenti per chirurgia micro



18,5 cm/7¹/₄"



KS 650/01



KS 650/02



KS 650/06

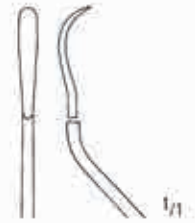

KS 650/07

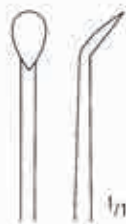

KS 650/03



KS 650/04

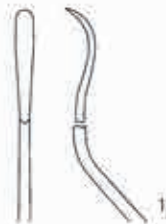

KS 650/08

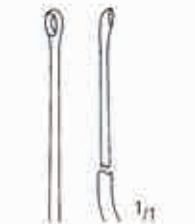

KS 650/09



KS 650/05



18,5 cm/7¹/₄"

Mikro-Instrumente
 Micro Instruments
 Instrumentos para microcirugia
 Instruments pour la chirurgie micro
 Strumenti per chirurgia micro

AA

AB

AC

AE

AK

AO

AB

KA

KS

XR

XT

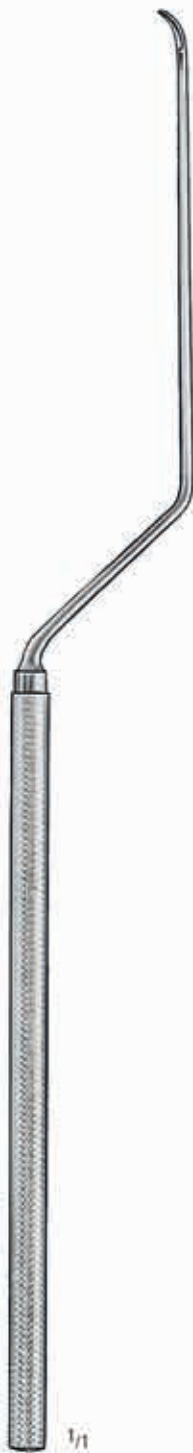

KOOS
 19,0 cm/7¹/₂"



KS 652/01



KS 652/02



KS 652/03



KS 652/04



KS 652/05



KS 652/06

Mikro-Instrumente
 Micro Instruments
 Instrumentos para microcirugía
 Instruments pour la chirurgie micro
 Strumenti per chirurgia micro

Schneide seitlich
 Lateral cutting edge
 Filo de corte lateral
 Trachant latéral
 Taglio laterale



KRAUS
 KS 653/19
 19,0 cm/7 1/2"



KS 654/01
 19,0 cm/7 1/2"



KS 654/02
 19,0 cm/7 1/2"

Mikro-Instrumente
 Micro Instruments
 Instrumentos para microcirugía
 Instruments pour la chirurgie micro
 Strumenti per chirurgia micro



KS 656/19

JACOBSON
 19,0 cm/7¹/₂"



KS 658/01

KS 658/02

KS 658/03

JACOBSON
 18,5 cm/7¹/₄"



CASPAR
 KS 659/23
 23,0 cm/9"

- AA
- AB
- AC
- AE
- AK
- AO
- AR
- KA
- KS**
- XR
- XT

Mikro-Instrumente
 Micro Instruments
 Instrumentos para microcirugía
 Instruments pour la chirurgie micro
 Strumenti per chirurgia micro



3 mm
 1/1
 KS 660/03



4 mm
 1/1
 KS 660/04



5 mm
 1/1
 KS 660/05



8 mm
 1/1
 KS 660/08



OKONEK
 1/1 23,0 cm/9"



1/1
 KS 665/01



1/1
 KS 665/02



1/1
 KS 665/03



1/1
 KS 665/04



1/1 19,0 cm/7 1/2"

Mikro-Instrumente
 Micro Instruments
 Instrumentos para microcirugía
 Instruments pour la chirurgie micro
 Strumenti per chirurgia micro

AA

AB

AC

AE

AK

AO

AB

KA

KS

XR

XT



KS 666/19
 Ø 1,8 mm
 18,5 cm/7 1/4"



KS 670/00



KS 670/01



KS 670/02

Rhoton Mikro Dissektoren
 Rhoton Micro Dissectors
 Rhoton micro disecadores
 Rhoton micro dissecteurs
 Rhoton micro dissetori



KS 680/01



KS 680/02



KS 680/03



KS 680/04



KS 680/05



KS 680/06



KS 680/07



KS 680/08



KS 680/09

RHOTON

Rhoton Mikro Dissektoren
 Rhoton Micro Dissectors
 Rhoton micro disecadores
 Rhoton micro dissecteurs
 Rhoton micro dissetori



RHOTON



KS 680/00 = KS 680/01 - KS 680/15

Set komplett, 15 Dissektoren
 Set complete, 15 dissectors
 Set completo, 15 disecadores
 Jeu complet, 15 dissecteurs
 Set completo, 15 dissetori

AA
 AB
 AC
 AE
 AK
 AO
 AR
 KA
 KR
 XT

KS

Mikro-Instrumente
 Micro Instruments
 Instrumentos para microcirugía
 Instruments pour la chirurgie micro
 Strumenti per la chirurgia micro

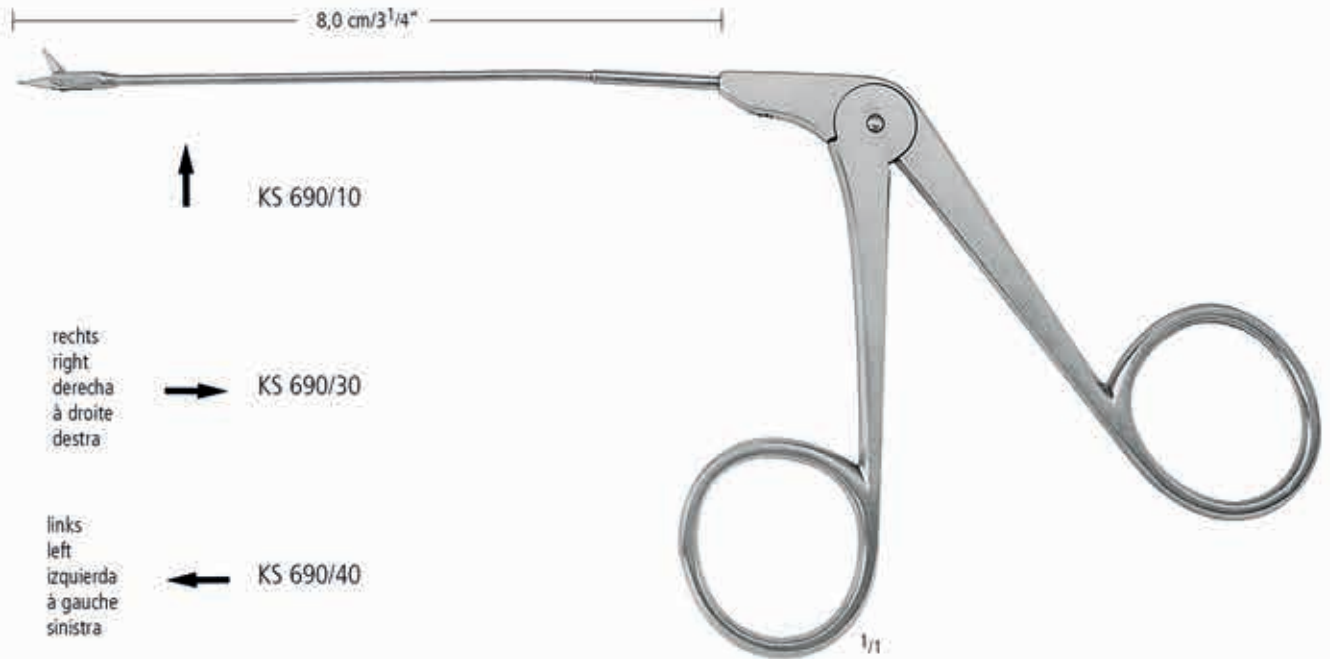

↑ KS 690/10

rechts
 right
 derecha
 à droite
 destra → KS 690/30

links
 left
 izquierda
 à gauche
 sinistra ← KS 690/40

BELLUCCI



FAHLBUSCH
 KS 693/17

Mikro-Instrumente
 Micro Instruments
 Instrumentos para microcirugía
 Instruments pour la chirurgie micro
 Strumenti per la chirurgia micro

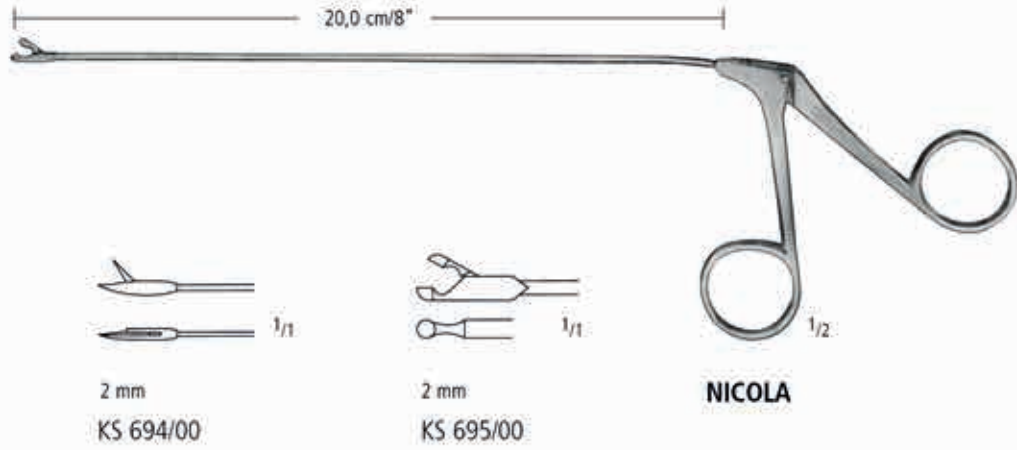

↑ 30° KS 694/10 KS 695/10

rechts
right
derecha
à droite
destra → KS 694/30 KS 695/30

links
left
izquierda
à gauche
sinistra ← KS 694/40 KS 695/40

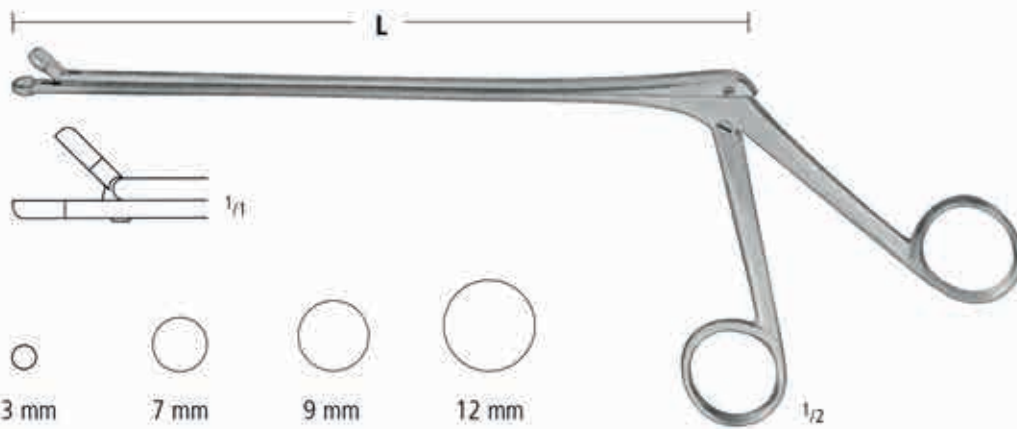

	L = 14,0 cm/5 1/2"	L = 18,0 cm/7"
∅ 3 mm	KS 696/03	KS 697/03
∅ 7 mm	KS 696/07	KS 697/07
∅ 9 mm	KS 696/09	KS 697/09
∅ 12 mm	KS 696/12	KS 697/12

AA
AB
AC
AE
AK
AO
AR
KA
KS
XR
XT

Laminektomie-Stanzen
 Laminectomy Punches
 Pinzas cortantes para discos intervertebrales
 Pinces emporte-pièces pour lames intervertébrales
 Pinze taglianti per dischi intervertebrali



KERRISON

Also available in
TITANIUM



1 mm	15,0 cm/6"	18,0 cm/7"	20,0 cm/8"
2 mm	KS 700/01	KS 701/01	KS 702/01
3 mm	KS 700/02	KS 701/02	KS 702/02
5 mm	KS 700/03	KS 701/03	KS 702/03
	KS 700/05	KS 701/05	KS 702/05

Also available in
TITANIUM

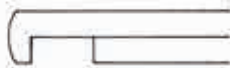

1 mm	15,0 cm/6"	18,0 cm/7"	20,0 cm/8"
2 mm	KS 706/01	KS 707/01	KS 708/01
3 mm	KS 706/02	KS 707/02	KS 708/02
5 mm	KS 706/03	KS 707/03	KS 708/03
	KS 706/05	KS 707/05	KS 708/05



1 mm	15,0 cm/6"	18,0 cm/7"	20,0 cm/8"
2 mm	KS 712/01	KS 713/01	KS 714/01
3 mm	KS 712/02	KS 713/02	KS 714/02
5 mm	KS 712/03	KS 713/03	KS 714/03
	KS 712/05	KS 713/05	KS 714/05

Laminektomie-Stanzen
 Laminectomy Punches
 Pinzas cortantes para discos intervertebrales
 Pincas emporte-pièces pour lames intervertébrales
 Pinze taglienti per dischi intervertebrali



easyClean®

ZERLEGBAR
 DETACHABLE
 DESMONTABLE
 DEMONTABLE
 SMONTABILE

	1 mm	18,0 cm/7"	20,0 cm/8"
	2 mm	KS 701/11	KS 702/11
	3 mm	KS 701/12	KS 702/12
	4 mm	KS 701/13	KS 702/13
	5 mm	KS 701/14	KS 702/14
	2 mm	18,0 cm/7"	20,0 cm/8"
	3 mm	KS 707/12	KS 708/12
	4 mm	KS 707/13	KS 708/13
	5 mm	KS 707/14	KS 708/14
	5 mm	KS 707/15	KS 708/15
	1 mm	18,0 cm/7"	20,0 cm/8"
	2 mm	KS 713/11	KS 714/11
	3 mm	KS 713/12	KS 714/12
	4 mm	KS 713/13	KS 714/13
	5 mm	KS 713/14	KS 714/14
5 mm	KS 713/15	KS 714/15	

AA

AB

AC

AE

AK

AO

AB

KA

KS

XR

XT

Laminektomie-Stanzen
 Laminectomy Punches
 Pinzas cortantes para discos intervertebrales
 Pincas emporte-pièces pour lames intervertébrales
 Pinze taglianti per dischi intervertebrali

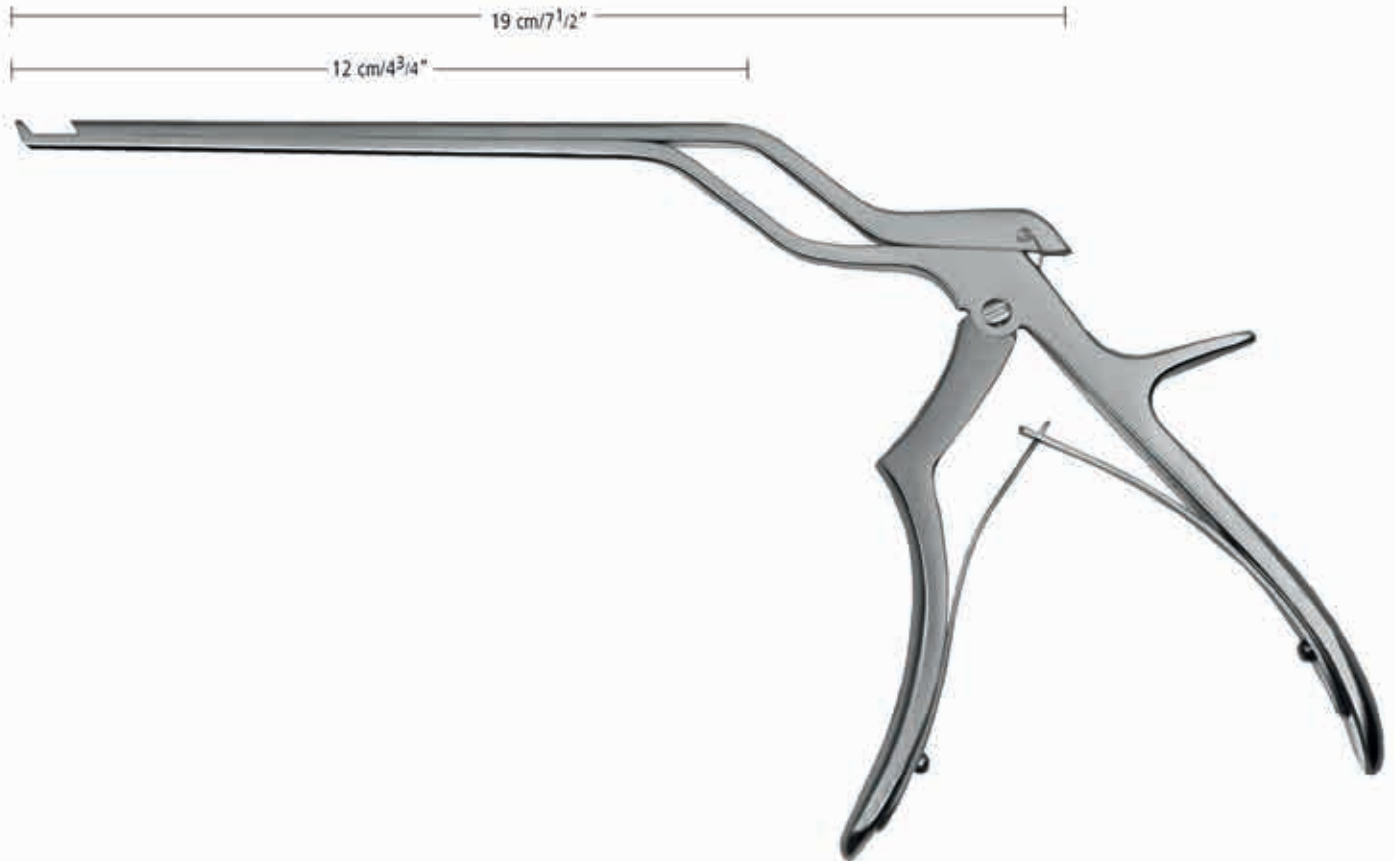

KERRISON-BAJONETT

12,0 cm/4³/₄"



- 2 mm
- 3 mm
- 4 mm
- 5 mm

- KS 715/12
- KS 715/13
- KS 715/14
- KS 715/15

Laminektomie-Stanzen
 Laminectomy Punches
 Pinzas cortantes para discos intervertebrales
 Pincas emporte-pièces pour lames intervertébrales
 Pinze taglienti per dischi intervertebrali



großer Griff
 large handle
 mango grande
 branche grande
 impugnatura grande

KERRISON-COLCLOUGH

Also available in
TITANIUM



	15,0 cm/6"	18,0 cm/7"	20,0 cm/8"	30,0 cm/12"
2 mm	KS 720/02	KS 721/02	KS 722/02	KS 725/02
3 mm	KS 720/03	KS 721/03	KS 722/03	KS 725/03
4 mm	KS 720/04	KS 721/04	KS 722/04	KS 725/04
5 mm	KS 720/05	KS 721/05	KS 722/05	KS 725/05

Also available in
TITANIUM



	15,0 cm/6"	18,0 cm/7"	20,0 cm/8"	30,0 cm/12"
2 mm	KS 726/02	KS 727/02	KS 728/02	KS 731/02
3 mm	KS 726/03	KS 727/03	KS 728/03	KS 731/03
4 mm	KS 726/04	KS 727/04	KS 728/04	KS 731/04
5 mm	KS 726/05	KS 727/05	KS 728/05	KS 731/05



	15,0 cm/6"	18,0 cm/7"	20,0 cm/8"	30,0 cm/12"
2 mm	KS 732/02	KS 733/02	KS 734/02	KS 737/02
3 mm	KS 732/03	KS 733/03	KS 734/03	KS 737/03
4 mm	KS 732/04	KS 733/04	KS 734/04	KS 737/04
5 mm	KS 732/05	KS 733/05	KS 734/05	KS 737/05

AA
 AB
 AC
 AE
 AK
 AO
 AR
 KA
 KS
 XR
 XT

Laminektomie-Zangen
 Laminectomy Rongeurs
 Pinzas cortantes para laminectomia
 Pincas emporte-pièces à laminectomie
 Pinze taglianti per laminectomia



Also available in
TITANIUM

CUSHING
LOVE-GRUENWALD
SPURLING



CUSHING
 2 x 10 mm



13,0 cm/5"	KS 742/00
15,0 cm/6"	KS 742/04
18,0 cm/7"	KS 742/08
20,0 cm/8"	KS 742/12
25,0 cm/10"	KS 742/16
30,0 cm/12"	KS 742/20

KS 742/01
KS 742/05
KS 742/09
KS 742/13
KS 742/17
KS 742/21

KS 742/03
KS 742/07
KS 742/11
KS 742/15
KS 742/19
KS 742/23

LOVE-GRUENWALD
 3 x 10 mm



13,0 cm/5"	KS 743/00
15,0 cm/6"	KS 743/04
18,0 cm/7"	KS 743/08
20,0 cm/8"	KS 743/12
25,0 cm/10"	KS 743/16
30,0 cm/12"	KS 743/20

KS 743/01
KS 743/05
KS 743/09
KS 743/13
KS 743/17
KS 743/21

KS 743/03
KS 743/07
KS 743/11
KS 743/15
KS 743/19
KS 743/23

SPURLING
 4 x 10 mm



13,0 cm/5"	KS 744/00
15,0 cm/6"	KS 744/04
18,0 cm/7"	KS 744/08
20,0 cm/8"	KS 744/12
25,0 cm/10"	KS 744/16
30,0 cm/12"	KS 744/20

KS 744/01
KS 744/05
KS 744/09
KS 744/13
KS 744/17
KS 744/21

KS 744/03
KS 744/07
KS 744/11
KS 744/15
KS 744/19
KS 744/23

Laminektomie-Zangen
 Laminectomy Rongeurs
 Pinzas cortantes para laminectomia
 Pincas emporte-pièces à laminectomie
 Pinze taglianti per laminectomia



 1/1
 2 x 3 mm
 KS 750/03

 1/1
 2 x 5 mm
 KS 750/05

 1/2
SELVERSTONE

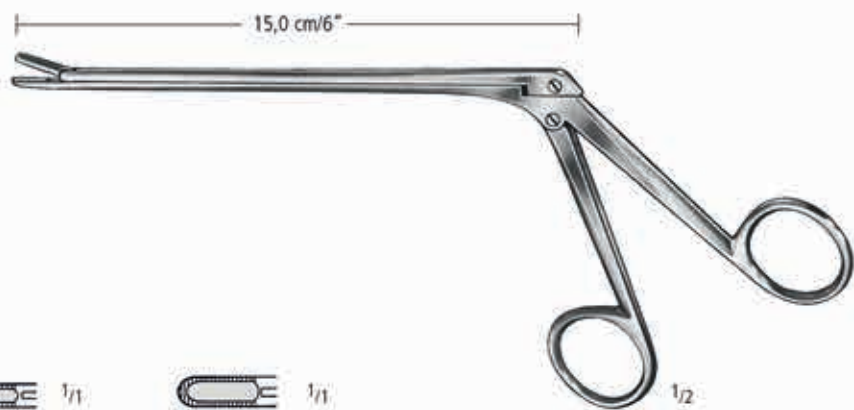

 1/1
 2 x 10 mm
 KS 752/02

 1/1
 3 x 10 mm
 KS 752/03

 1/1
 4 x 10 mm
 KS 752/04

 1/2
SCHLESINGER

AA
 AB
 AC
 AE
 AK
 AO
 AB
 KA
 KS
 XR
 XT

Laminektomie-Zangen
 Laminectomy Rongeurs
 Pinzas cortantes para laminectomia
 Pinces emporte-pièces à laminectomie
 Pinze taglianti per laminectomia



2 x 10 mm
 KS 754/02



3 x 10 mm
 KS 754/03



4 x 10 mm
 KS 754/04

CASPAR



6 x 10 mm

CLOWARD



KS 756/01



KS 756/02







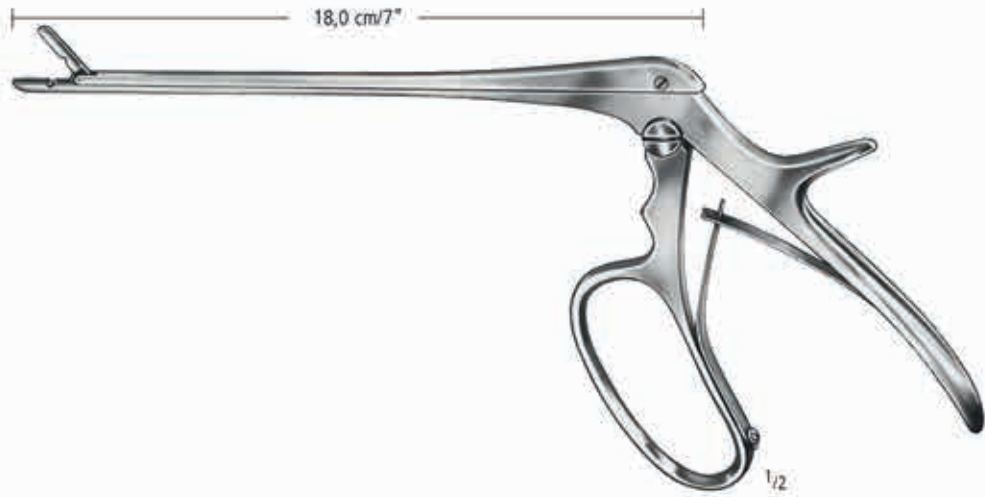

KS 756/03

Laminektomie-Zangen
 Laminectomy Rongeurs
 Pinzas cortantes para laminectomia
 Pincas emporte-pièces à laminectomie
 Pinze taglienti per laminectomia



FERRIS-SMITH-CUSHING

	 1/1	 1/1	 1/1	 1/1
 1/1	2 x 10 mm KS 762/00	3 x 10 mm KS 763/00	4 x 10 mm KS 764/00	6 x 12 mm KS 766/00
 1/1	KS 762/01	KS 763/01	KS 764/01	KS 766/01
 1/1	KS 762/03	KS 763/03	KS 764/03	KS 766/03



OLDBERG
 KS 770/00

AA
 AB
 AC
 AE
 AK
 AO
 AR
 KA
 KS
 XR
 XT

Laminektomie-Stanzen
 Laminectomy Punches
 Pinzas cortantes para discos intervertebrales
 Pincas emporte-pièces pour lames intervertébrales
 Pinze taglienti per dischi intervertebrali

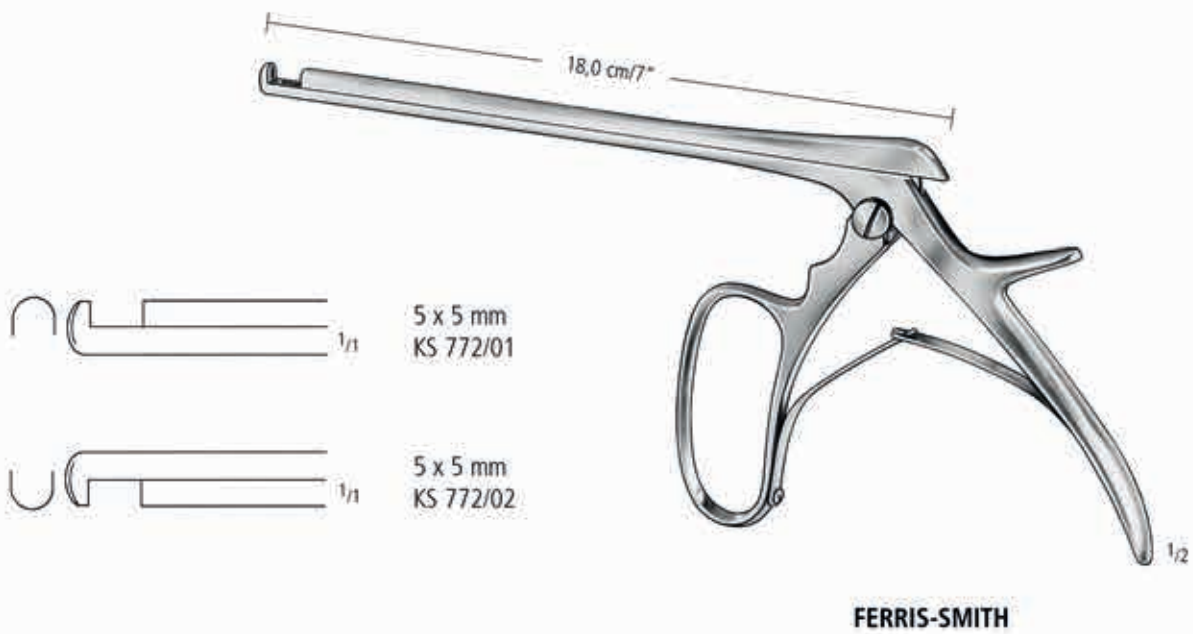

Laminektomie-Stanzen
 Laminectomy Punches
 Pinzas cortantes para discos intervertebrales
 Pinces emporte-pièces pour lames intervertébrales
 Pinze taglienti per dischi intervertebrali

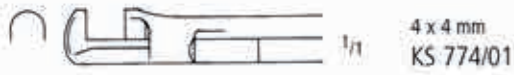

4 x 4 mm
 KS 774/01

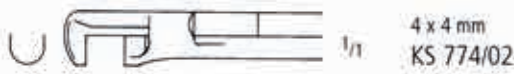

4 x 4 mm
 KS 774/02



3,5 x 3,5 mm
 KS 774/03

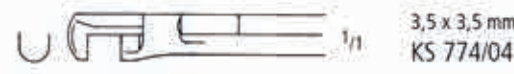

3,5 x 3,5 mm
 KS 774/04



HAJEK-KOFFLER



HAJEK-KOFFLER
 KS 774/16



KERRISON

3 x 3 mm
 KS 775/01

4 x 4 mm
 KS 775/02

5 x 5 mm
 KS 775/03

6 x 6 mm
 KS 775/04

AA

AB

AC

AE

AK

AO

AB

KA

KS

XR

XT

Laminektomie-Stanzen
 Laminectomy Punches
 Pinzas cortantes para discos intervertebrales
 Pincas emporte-pièces pour lames intervertébrales
 Pinze taglianti per dischi intervertebrali

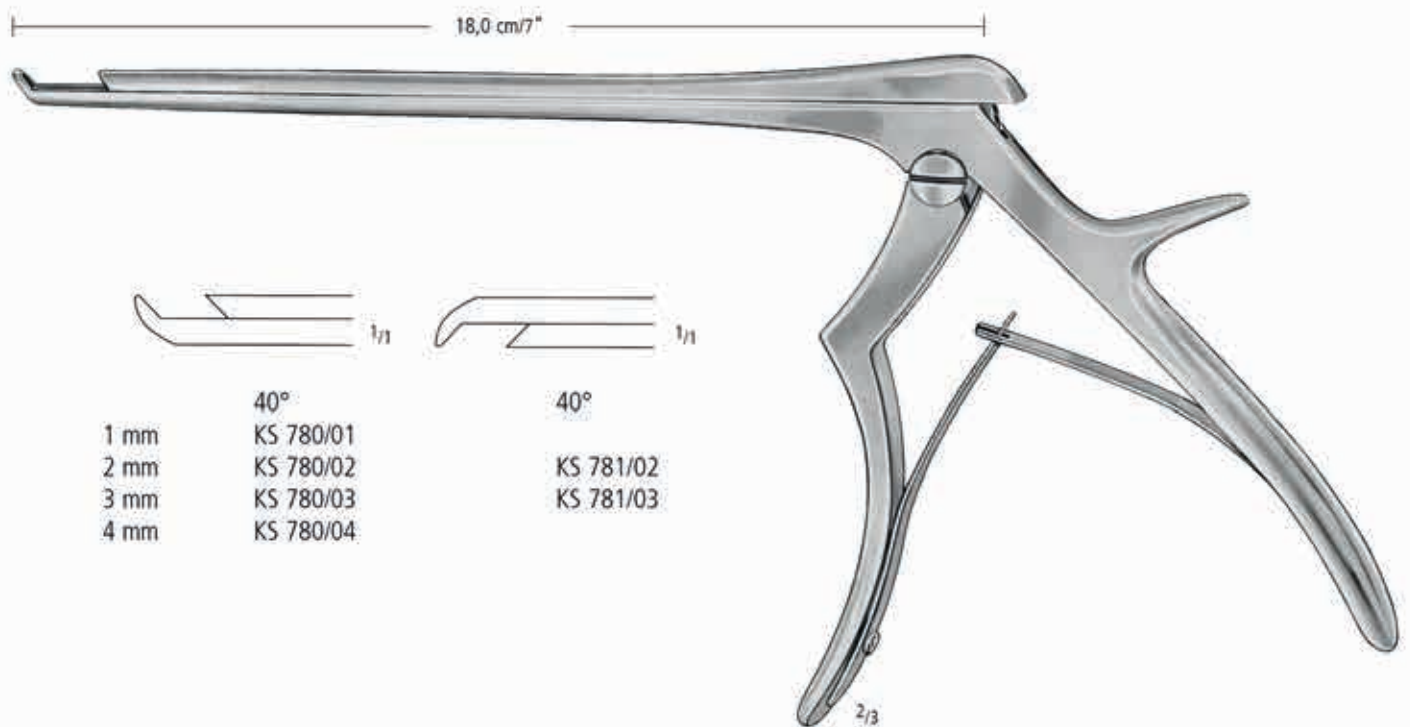

	40°
1 mm	KS 780/01
2 mm	KS 780/02
3 mm	KS 780/03
4 mm	KS 780/04

40°
KS 781/02
KS 781/03

PLATTFUSS

Hypophysen-Instrumente
 Pituitary Instruments
 Instrumentos para hipófisis
 Instruments pour la chirurgie pituitaire
 Strumenti per ipofisi cerebrale

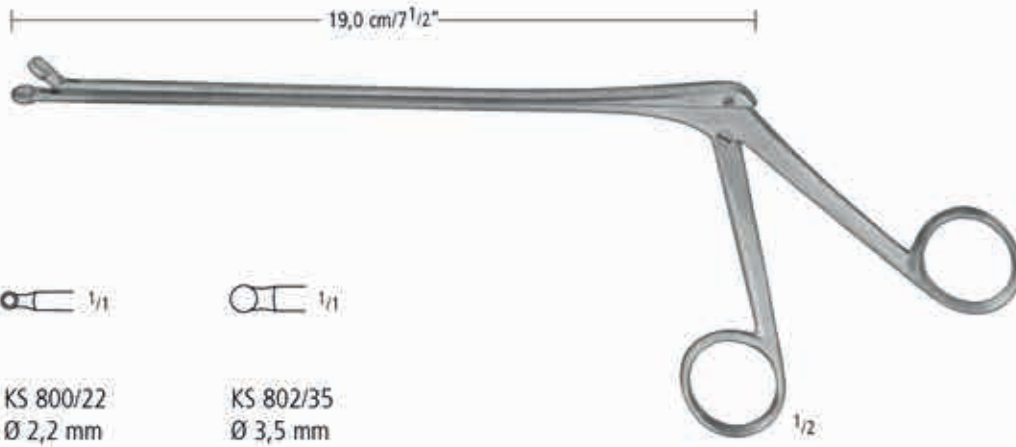

LANDOLT
 KS 804/09
 Ø 9 mm

AA
 AB
 AC
 AE
 AK
 AO
 AB
 KA
 KR
 XT

KS

Hypophysen-Instrumente
 Pituitary Instruments
 Instrumentos para hipófisis
 Instruments pour la chirurgie pituitaire
 Strumenti per ipofisi cerebrale



CUSHING-LANDOLT

L	
70 x 15 mm	KS 820/01
90 x 15 mm	KS 820/02
110 x 15 mm	KS 820/03



LANDOLT
 KS 821/21
 21,5 cm/8 1/2"



COTTLE
 KS 822/04
 18 cm/7"

Hypophysen-Instrumente
 Pituitary Instruments
 Instrumentos para hipófisis
 Instruments pour la chirurgie pituitaire
 Strumenti per ipofisi cerebrale



RAY
 18,0 cm/7¹/₄"



Ø 4 mm
 KS 830/18



Ø 4 mm
 KS 831/18

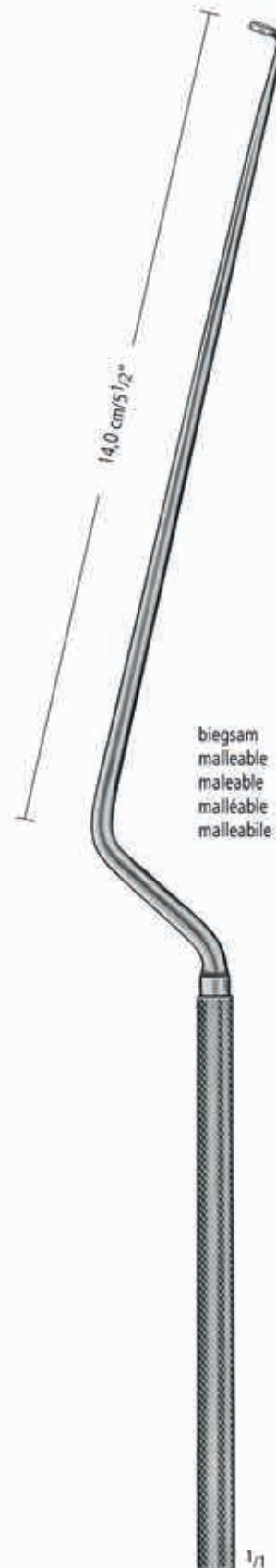

HARDY
 26,0 cm/10¹/₄"



Ø 4 mm
 KS 832/04



Ø 6 mm
 KS 832/06

biegsam
 malleable
 maleable
 malleable
 malleabile

Hypophysen-Instrumente
 Pituitary Instruments
 Instrumentos para hipófisis
 Instruments pour la chirurgie pituitaire
 Strumenti per ipofisi cerebrale

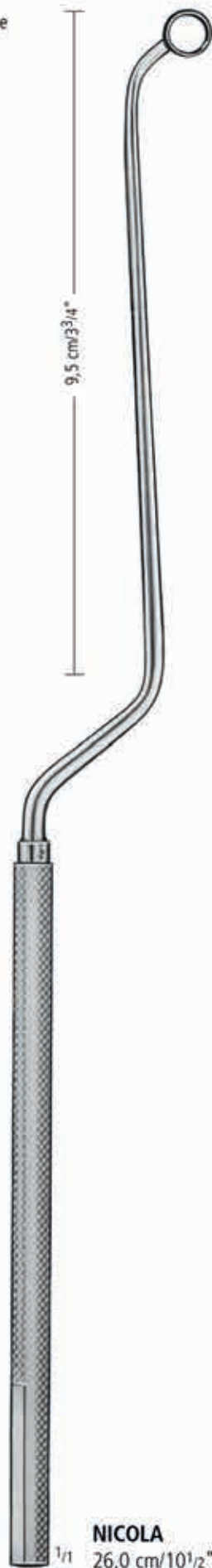

9,5 cm/3 3/4"



KS 834/01
 biegsam
 malleable
 maleable
 malléable
 malleabile



KS 834/02
 biegsam
 malleable
 maleable
 malléable
 malleabile



KS 835/22



KS 836/22

NICOLA
 26,0 cm/10 1/2"

Hypophysen-Instrumente
 Pituitary Instruments
 Instrumentos para hipófisis
 Instruments pour la chirurgie pituitaire
 Strumenti per ipofisi cerebrale



HARDY
 1/1 26,0 cm/10 1/4"



KS 837/01
 stumpf
 blunt
 romo
 mousse
 smusso



KS 837/02
 stumpf
 blunt
 romo
 mousse
 smusso



KS 837/03
 scharf
 sharp
 cortante
 tagliente



KS 837/04
 scharf
 sharp
 cortante
 tagliente



HARDY
 KS 838/25



HARDY-FAHLBUSCH
 KS 839/01
 scharf
 sharp
 cortante
 tagliente



HARDY-FAHLBUSCH
 KS 839/02
 scharf
 sharp
 cortante
 tagliente

AA
 AB
 AC
 AE
 AK
 AO
 AR
 KA
 KR
 XT

KS

Hypophysen-Instrumente
 Pituitary Instruments
 Instrumentos para hipófisis
 Instruments pour la chirurgie pituitaire
 Strumenti per ipofisi cerebrale

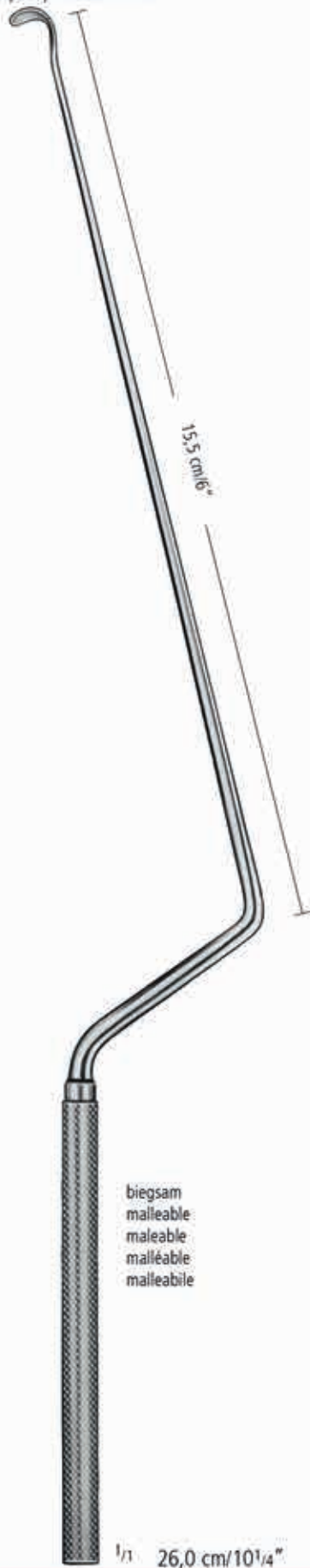

LANDOLT
KS 840/01



LANDOLT
KS 840/02

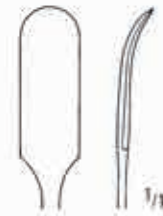

LANDOLT
KS 841/26



LANDOLT
KS 842/26



LANDOLT
KS 843/26



FAHLBUSCH
KS 844/26



FAHLBUSCH
KS 845/26

Hypophysen-Instrumente
 Pituitary Instruments
 Instrumentos para hipófisis
 Instruments pour la chirurgie pituitaire
 Strumenti per ipofisi cerebrale



HOSOBUCHI
 KS 846/26



LANDOLT-REULEN
 Ø 2,2 mm
 KS 847/22



LANDOLT-REULEN
 Ø 3,2 mm
 KS 847/32



LANDOLT-REULEN
 Ø 2,5 mm
 KS 848/25



LANDOLT-REULEN
 Ø 1,7 mm
 KS 849/17



LANDOLT-REULEN
 Ø 2,0 mm
 KS 850/20

AA
 AB
 AC
 AE
 AK
 AO
 AB
 KA
 KS
 XR
 XT

ENDOSKOPIE
ENDOSCOPY
ENDOSCOPIA
ENDOSCOPIE
ENDOSCOPIA

XR

nopa[®] instruments

Unser komplettes **Endoskopie**-Programm finden Sie in Katalog **X - ENDOSKOPIE**.

For our complete program in **endoscopy** please refer to catalogue **X - ENDOSCOPY**.

Para nuestro programa completo de **endoscopia** vea el catálogo **X - ENDOSCOPIA**.

Pour notre programme complet d'**endoscopie** voir le catalogue **X - ENDOSCOPIE**.

Per la nostra gamma completa di **endoscopia** la preghiamo di consultare il catalogo **X - ENDOSCOPIA**.



Anschlußkabel
 Connection Cords
 Cables de connexion
 Câbles de raccordement
 Cavi da connessione

monopolar

bipolar



MARTIN/BERCHTOLD

300 cm XR 827/03
 500 cm XR 827/05

XR 828/03
 XR 828/05

XR 830/03
 XR 830/05

monopolar

bipolar

monopolar

bipolar



ERBE
 300 cm XR 831/03
 500 cm XR 831/05
 (ACC/ICC)

ERBE
 XR 831/13
 XR 831/15
 (T-Serie)

ERBE/SELECT
 XR 832/03
 XR 832/05

ERBE
 XR 833/03
 XR 833/05

VALLEYLAB
 XR 834/03
 XR 834/05
 (in D nicht zulässig
 nach MedGV)

ENDOSKOPIE ENDOSCOPY ENDOSCOPIA ENDOSCOPIE ENDOSCOPIA

Bi-Koagulations-Pinzetten
 Bi-Coagulation-Forceps
 Pinzas para la Bi-Coagulación
 Pince pour la Bi-Coagulation
 Pinze per la Bi-Coagulazione



16,0 cm/6 1/4"	XR 890/16 A	XR 891/16 C	XR 894/16 C		
16,0 cm/6 1/4"	XR 890/16 C	XR 891/16 D	XR 894/16 D		
16,0 cm/6 1/4"	XR 890/16 E	XR 891/16 E	XR 894/16 E		
20,0 cm/8"	XR 890/20 A	XR 891/20 A	XR 894/20 A		
20,0 cm/8"	XR 890/20 C	XR 891/20 C	XR 894/20 C	XR 895/20 C	XR 896/20 C
20,0 cm/8"	XR 890/20 E	XR 891/20 F	XR 894/20 E		
20,0 cm/8"			XR 894/20 F		
22,0 cm/8 3/4"	XR 890/22 A	XR 891/22 C	XR 894/22 D		
22,0 cm/8 3/4"	XR 890/22 C		XR 894/22 E	XR 895/22 C	XR 896/22 C

A=2,0 mm

C=1,0 mm



D=0,5 mm

E=Nadel

F=Profil



11,0 cm/4 1/4"	XR 898/11 D	XR 899/11 D
11,0 cm/4 1/4"	XR 898/11 E	XR 899/11 E

ENDOSKOPIE
ENDOSCOPY
ENDOSCOPIA
ENDOSCOPIE
ENDOSCOPIA

XT

nopa[®] instruments

Unser komplettes **Endoskopie**-Programm finden Sie in Katalog **X - ENDOSKOPIE**.

For our complete program in **endoscopy** please refer to catalogue **X - ENDOSCOPY**.

Para nuestro programa completo de **endoscopia** vea el catálogo **X - ENDOSCOPIA**.

Pour notre programme complet d'**endoscopie** voir le catalogue **X - ENDOSCOPIE**.

Per la nostra gamma completa di **endoscopia** la preghiamo di consultare il catalogo **X - ENDOSCOPIA**.



Kaltlichtkabel
 Fibre optic cable
 Cable fibra óptica
 Câble fibre optique
 Cavo fibra ottica



Kaltlichtkabel-Grundkabel
Basic fibre optic cable

XT 035/18	Ø 3,5 mm, 180 cm
XT 035/23	Ø 3,5 mm, 230 cm
XT 035/30	Ø 3,5 mm, 300 cm
XT 045/18	Ø 4,5 mm, 180 cm
XT 045/23	Ø 4,5 mm, 230 cm
XT 045/30	Ø 4,5 mm, 300 cm
XT 060/18	Ø 6,0 mm, 180 cm
XT 060/23	Ø 6,0 mm, 230 cm
XT 060/30	Ø 6,0 mm, 300 cm



XT 070/18	Ø 3,5 mm, 180 cm
XT 070/23	Ø 3,5 mm, 230 cm
XT 070/30	Ø 3,5 mm, 300 cm

- >> **Zusätzliche Isolierung**
- >> **Metallspirale**
- >> **Silikonmantel**
- >> **Sterilisierbar**

- >> **Additionally insulated**
- >> **Metal spiral**
- >> **Silicon tube**
- >> **Autoclavable**

AA
AB
AC
AE
AK
AO
AR
KA
KS
XR

XT

Adapter
Adapter
Adaptador
Connexion
Adattatore

**Projektor-Seite
Projector side**

**Endoskop-Seite
Endoscope side**

XT 100/01



STORZ



XT 100/11

**STORZ/WINTER + IBE
OLYMPUS/STRYKER**

XT 100/02



WOLF/HENKE-SASS



XT 100/12

WOLF/HENKE-SASS

XT 100/03



ACM/HEINE



XT 100/13

ACM/HEINE

XT 100/04



WINTER + IBE

XT 100/05



OLYMPUS

Bestellinformation / Ordering information

**>> Bitte bestellen Sie Kaltlicht-
grundkabel mit 2 Adaptern**

**>> Please order the basic fibre
optic cable and two adapters**

Kaltlichtquellen
Cold Light Sources
Fuente de luz fría
Source à lumière froide
Sorgente luce fredda

nopa[®] light halogen 2 x 250W future 100



XT 170/00 = 110 - 230 VAC

XT 169/00 = Ersatzlampe
Spare bulb
Bombilla de recambio
Lampe de rechange
Lampadina di ricambio

nopalight halogen 2 x 250W

Beschreibung XT 170/00

Die nopalight halogen 2 x 250 W Lichtquelle kann bei allen Einsätzen angewendet werden, besonders dann, wenn eine starke Ausleuchtung oder eine Videoaufzeichnung notwendig ist.

Alle modernen Autoshutter-Videokameras werden mit ausreichender Lichtzufuhr versorgt. Die zweite Lampe wird als Reserve bei Lampendefekten oder Lampenausfall durch sofortiges Umschalten während den Einsätzen aktiviert.

Spezielle Wärmeschutzfilter sorgen für eine Schonung der Lichtleiter und eine optimale Lichtfiltrierung. Das Gerät ist MedGV-geprüft.

Technische Daten

Elektr. Versorgung:	100-240 VAC/50-60Hz Weltnetzteil
Farbtemperatur:	über 3500° K
Lichtregelung:	automatisch, stufenlos
Maße (B x H x T):	355 x 110 x 320 mm
Gewicht:	ca. 8,5 kg

Zubehör

Lampe XT 169/00: 250 Watt Halogen

nopalight halogen 2 x 250W

Description XT 170/00

The nopalight halogen 2 x 250 W lightsource can be utilized in all procedures, especially if a strong illumination or video-monitoring is required.

All modern autoshutter-videocameras will be supplied with sufficient light-intensity, the second lamp serves as stand-by. Simply switch-over.

Special temperature-filters guarantee long life of light cables and optimal light output. The nopalight halogen 2 x 250 W lightsource is approved by MedGV.

Technical data

Power supply:	100-240 VAC/50-60Hz world power supply
Color temperature:	more than 3500° K
Light control:	automatic
Measurements (W x H x D):	355 x 110 x 320 mm
Weight:	approx. 8,5 kg

Accessories

Bulb XT 169/00: 250 Watt Halogen



Inhaltsverzeichnis

	Seite		Seite
A			
Adapter	176	COTTLE , Hämmer	69
ADSON , Durahaken	131	COTTLE , Meissel	162
ADSON , Elevatorien	73	CRILE-WOOD, BABY Hartmetallnadelhalter TUC	38
ADSON , Hartmetallpinzetten TUC	20	CRILE-WOOD , Hartmetallnadelhalter TUC	38
ADSON , Pinzetten	12	CRUTCHFIELD , Schädelhalter	100
ADSON , Saugrohre	56	CUSHING , Pinzetten	13
ADSON , Wundsperrerr	50	CUSHING , Durahaken	131
ADSON-ANDERSON , Wundsperrerr	49	CUSHING , feine Wundhaken	45
ADSON-BABY , Arterienklemmen	9	CUSHING , Hartmetallpinzetten TUC	20
ADSON-BECKMANN , Wundsperrerr	52	CUSHING , Laminektomie-Stanzen	154
ADSON-BROWN , Pinzetten	12	CUSHING , Spinalhaken	46
ADSON-MICRO , Pinzetten	12	CUSHING-FERRIS-SMITH , Laminektomie-Zangen	157
ADSON-TOENNIS-DELICATE , Hartmetallscheren TUC	33	CUSHING-LANDOLT , Spekula für Hypophysektomie	162
ALM , Wundsperrerr	48	CUSHING-TAYLOR , Hartmetallpinzetten TUC	20
ALY , Sensibilitäts-Instrumente	60	D	
Anatomische Pinzetten	12,13	DAHLGREEN , Schädelzangen	99
ANDERSON-ADSON , Wundsperrerr	49	DAHMEN , Meissel	68
Aneurysmen- und Gefässclips	109-111	DAHMEN , Osteotome	68
Anlegezangen	105-107	DANDY , Nervhaken	129
Anlegezangen für Aneurysmen-Clips	112,113	DANDY , Präparierklemmen	10
Anschlusskabel	170	DANDY , Scheren	22
Arterienklemmen	9, 85	DAVIS , Dura Dissektoren	132
Atraumatische Pinzetten	19	DE BAKEY , atraumatische Pinzetten	19
AUSTIN , Knüpfpinzetten mit Plateau	16	DE BAKEY , Hartmetallnadelhalter TUC	36
B			
BABINSKY , Perkussionshämmer	58	DE VILBISS , Schädelzangen	99
BABY-ADSON , Arterienklemmen	9	DÉJERINE , Perkussionshämmer	59
BABY-CRILE-WOOD , Hartmetallnadelhalter TUC	38	DIETHRICH , Mikro-Pinzetten	90
BABY-MIXTER , Präparierklemmen	10	Dissektoren, Rhoton-	146,147
BABY-OVERHOLT , Arterienklemmen	9	Drahtsägen	98
BACON , Hohlmeisselzangen	76	Dura Dissektoren	132-135
BARRAQUER , Mikro-Nadelhalter	94	Durahaken	131
BECKMANN , Wundsperrerr	51	E	
BECKMANN-ADSON , Wundsperrerr	52	EasyClean Laminektomie-Zangen	151,152
BECKMANN-EATON , Wundsperrerr	52	EATON-BECKMANN , Wundsperrerr	52
BELLUCCI , Mikro-Instrumente	148	ECHLIN , Hohlmeisselzangen	79
BERLINER , Perkussionshämmer	59	Einführungssonden	98
BEYER , Hohlmeisselzangen	77	Elevatorien	72,73
BIEMER , Nervhaken	130	F	
BLUMENTHAL , Hohlmeisselzangen	75	FAHLBUSCH , Hypophysen-Instrumente	165
BÖHLER , Hohlmeisselzangen	77	FAHLBUSCH , Mikro-Instrumente	148
Bohrer, Hand-	62,63	FAHLBUSCH-HARDY , Hypophysen-Instrumente	165
BROWN-ADSON , Pinzetten	12	Fasspinzetten	15
BUCK , Perkussionshämmer	58	Feine Wundhaken	44,45
C			
CASPAR , Laminektomie-Zangen	156	FERGUSSON , Saugrohre	56
CASPAR , Mikro-Instrumente	137,138,143	FERRIS-SMITH , Laminektomie-Stanzen	158
CASPAR , Wundspreizer	119	FERRIS-SMITH-CUSHING , Laminektomie-Zangen	157
CASPAR , Wundspreizer Wirbelsäule	116,118	FISCH , Nervhaken	130
CASTROVIEJO , Hartmetallnadelhalter TUC	40	FOX-GOLDMAN , Hartmetallscheren TUC	33
Chirurgische Pinzetten	12,13	FRAZIER , Dura Dissektoren	133
CLEVELAND , Hohlmeisselzangen	74	FRAZIER , feine Wundhaken	44
Clips	105,107,109-111	FRAZIER , Saugrohre	56
CLOWARD modif., Wundspreizer	122	FREER , Elevatorien	72
CLOWARD , Laminektomie-Stanzen	156	FRIEDMAN , Hohlmeisselzangen	74
CLOWARD , scharfe Löffel	71	FRIEDMAN-MINI , Hohlmeisselzangen	74
CLOWARD , Wirbelkörperspreizer	122,124	FRYKHOLM , Hohlmeisselzangen	79
COLCLOUGH-KERRISON , Laminektomie-Stanzen	153	G	
CONE , Wundsperrerr	51	Galeahaken	108
CONTOUR-SCALP , Wundsperrerr	53	GEMINI , Präparierklemmen	10
CONVERSE , Hartmetallnadelhalter TUC	37	GILLIES , feine Wundhaken	44

GOLDMAN-FOX , Hartmetallscheren TUC	33
GRAHAM , Durahaken	131
GRONINGEN , Nervhaken	129
GRUENWALD-LOVE , Laminektomie-Stanzen	154

H

HAJEK-KOFFLER , Laminektomie-Stanzen	159
Hakengriffe für Drahtsägen	98
HALSEY , Hartmetallnadelhalter TUC	37
Hämmer	58,59,69,70
Hammer, Perkussion-	58,59
Handbohrapparate	62,63
HARDY , Hypophysen-Instrumente	163,165
HARDY-FAHLBUSCH , Hypophysen-Instrumente	165
HARMS , Wirbelkörperspreizer	125
HARTMANN , Hohlmeisselzangen	75
HAVERFIELD-SCOVILLE , Wundspreizer	120
HEGAR-MAYO , Hartmetallnadelhalter TUC	36
HEGAR-MAYO-DELICATE , Hartmetallnadelhalter TUC	36
HEIFETZ , Fasspinzetten	15
HEIFETZ , Hirnspatel	104
HEY , Muskelspreizer	114
HIBBS SPRATT , scharfe Löffel	71
Hirn-Retraktor	101-103
Hirnspatel	104
Hochfrequenzkabel	178
HOEN , Arterienklemmen	85
HOEN , Dura Dissektoren	133
HOEN , Elevatorien	73
Hohlmeissel	66-68
Hohlmeisselzangen	74-80
HORSLEY , Nervwurzelhaken	127
HOSOBUCHI , Hypophysen-Instrumente	167
HUNT , Fasspinzetten	15
Hypophysen-Instrumente	161-167
Hypophysen-Zangen	161

I

INGE , Wirbelkörperspreizer	126
Instrumente, Mikro-	87,136-145,148-149
Instrumente zur Schädelöffnung	98,99

J

JACOBSON , Hartmetallnadelhalter TUC	40
JACOBSON , Mikro-Instrumente	143
JACOBSON , Mikro-Nadelhalter	42
JANSEN , Wundsperrer	48
JANSEN-ZAUFAL , Hohlmeisselzangen	77

K

Kaltlichtkabel	175
Kaltlichtquellen	176,177
KERRISON , Laminektomie-Stanzen	150,159
KERRISON-COLCLOUGH , Laminektomie-Stanzen	153
KILNER , feine Wundhaken	44
Klammerblock	107
KLEINERT-KUTZ , feine Wundhaken	44
KLEINERT-KUTZ , Hohlmeisselzangen	77
Klemmen	8-10,85-86
Klemmen, Arterien-	9,85
Klemmen, Kopfhaut-	8
Klemmen, Präparier-	10
Knüpfpinzetten mit Plateau	16,17
Koagulations-Pinzetten, bipolar	171
KOFFLER-HAJEK , Laminektomie-Stanzen	159
KÖLNER , Clips	107
KOOS , Mikro-Instrumente	141

Kopfhautklemmen	8
KRAUS , Mikro-Instrumente	142
KRAYENBÜHL , Nervhaken	130
KUTZ-KLEINERT , Hohlmeisselzangen	77

L

Laminektomie-Stanzen	150-153,158-160
Laminektomie-Zangen	154-157
LANDOLT , Hypophysen-Instrumente	166
LANDOLT , Hypophysen-Zangen	161
LANDOLT , Spreizzange	162
LANDOLT-CUSHING , Spekula für Hypophysektomie	162
LANDOLT-REULEN , Hypophysen-Instrumente	167
LANGENBECK , Elevatorien	72
LANGENBECK , Hartmetallnadelhalter TUC	39
LEKSELL-STILLE , Hohlmeisselzangen	79
LEMPERT , Hohlmeisselzangen	76
LEXER , Hartmetallscheren TUC	31
LEXER , Meissel	66,67
LEXER , Osteotome	67
LEXER-MINI , Meissel	66
LEYLA , Hirn-Retraktor	101-103
LISTER , Hartmetallscheren TUC	33
Löffel, scharf	71
LOVE modif., Nervwurzelhaken	128
LOVE , Nervwurzelhaken	128
LOVE-GRUENWALD , Laminektomie-Stanzen	154
LUER , Hohlmeisselzangen	75

M

MARQUARDT , Hohlmeisselzangen	76
MARTEL , Einföhrungssonde	98
MARTEL , Kopfhautklemmen	8
MARTIN , Nervwurzelhaken	128
MATHIEU , Hartmetallnadelhalter TUC	39
MATHIEU-DELICATE , Hartmetallnadelhalter TUC	39
MATHIEU-RYDER-MICRO , Hartmetallnadelhalter TUC	39
MAYFIELD , Hohlmeisselzangen	76
MAYO , Hartmetallscheren TUC	29
MAYO-HEGAR , Hartmetallnadelhalter TUC	36
MAYO-HEGAR-DELICATE , Hartmetallnadelhalter TUC	36
MC KENZIE , Anlegezangen	106
MC KENZIE , Klammerblock	107
MEAD , Hohlmeisselzangen	75
Meissel	66-68
METZENBAUM , Hartmetallscheren TUC	29-32
METZENBAUM-DELICATE , Hartmetallscheren TUC	31,32
MEYERDING , Wundhaken	47
MICRO , MATHIEU-RYDER , Hartmetallnadelhalter TUC	39
MICRO-ADSON , Pinzetten	12
MICRO-MOSQUITO , Arterienklemmen	9
MICRO-RYDER , Hartmetallnadelhalter TUC	37
MICRO-WULLSTEIN , Saugrohre	56
Mikro-Instrumente	87,136-145,148-149
Mikro-Nadelhalter	41,42,94
Mikro-Pinzetten	16-18,88-90
Mikro-Scheren	23-28,91-93
MILLES , Mikro-Scheren	92
MILLIGAN , Dura Dissektoren	134
MINI , Anlegezangen für Aneurysmen-Clips	113
MINI-FRIEDMAN , Hohlmeisselzangen	74
MINI-LEXER , Meissel	66
MINI-RUSKIN , Hohlmeisselzangen	77
MIXTER-BABY , Präparierklemmen	10
MOLDESTAD , feine Wundhaken	45
MOSQUITO-MICRO , Arterienklemmen	9
Muskelspreizer	114,115

	Seite		Seite
N		Saugrohre	56
Nadelhalter	35-42,94-97	SCALP-CONTOUR , Wundsperrerr	53
Nadelhalter, Hartmetall TUC	36-40	Schädelhalter	100
Nadelhalter, Mikro	41,42,94	Schädelzangen	99
NAGEL , Mikro-Scheren	91	Scheren	21-34,91-93
Nahtpinzetten	89	Scheren, Hartmetall TUC	29-33
NEIVERT , Hartmetallnadelhalter TUC	37	Scheren, Mikro	23-28,91-93
Nervhaken	129,130	SCHLESINGER , Laminektomie-Zangen	155
Nerv-Präparierschere	22	SCHMIEDEN-TAYLOR , Scheren	22
Nervwurzelhaken	127	SCOVILLE , Anlegezangen	106
NICOLA , Hypophysen-Instrumente	164	SCOVILLE , Nervwurzelhaken	127
NICOLA , Mikro-Instrumente	149	SCOVILLE , Wundspreizer	120
		SCOVILLE-HAVERFIELD , Wundspreizer	120
O		SCOVILLE-RICHTER , Wundspreizer	121
OKONEK , Mikro-Instrumente	144	SELVERSTONE , Laminektomie-Zangen	155
OLDBERG , Laminektomie-Zangen	157	SEMB , Hohlmeisselzangen	78
OLIVECRONA , Dura Dissektoren	134	Sensibilitäts-Instrumente	60
OLIVECRONA , Hirnspatel	104	SMITH-FERRIS , Laminektomie-Stanzen	158
OLIVECRONA , Scheren	22	SMITH-FERRIS-CUSHING , Laminektomie-Zangen	157
OLIVECRONA-GIGLI , Drahtsägen	98	SMITH-PETERSON , Hohlmeisselzangen	80
OLIVECRONA-TOENNIS , Anlegezangen	106	SMITHWICK , Nervhaken	129
OMBREDANNE , Hämmer	69	SNITMAN , Wundsperrerr	48
Osteotome	66,67	Spekula für Hypophysektomie	162
OVERHOLT-BABY , Arterienklemmen	9	SPINAL FUSION , scharfe Löffel	71
		Spinalhaken	46
P		Spreizzange für Hypophysektomie	162
PENFIELD , Dura Dissektoren	135	SPURLING , Laminektomie-Stanzen	154
Perkussionshämmer	58,59	STANDARD , Anlegezangen für Aneurysmen-Clips	113
PETERSON-SMITH , Hohlmeisselzangen	80	STANDARD , Hartmetallscheren TUC	29
Pinzetten	11-20,89-90	Stanzen, Laminektomie-	150-153,159-160
Pinzetten, anatomisch	12,13	STELLBRINK , Hohlmeisselzangen	74
Pinzetten, atraumatisch	19	STILLE , Handbohrapparate	62
Pinzetten, BI-Koagulation	171	STILLE , Hohlmeisselzangen	78
Pinzetten, chirurgisch	12,13	STILLE-LEKSELL , Hohlmeisselzangen	79
Pinzetten, Fass-	15	STILLE-RUSKIN , Hohlmeisselzangen	78
Pinzetten, Hartmetall TUC	20	STRULLY , Scheren	22
Pinzetten, Knüpf-	16, 17		
Pinzetten, Mikro-	18	T	
Pinzetten, Mikro-	16-18,88-90	TAYLOR , Perkussionshämmer	58
Pinzetten, Naht-	89	TAYLOR , Spinalhaken	46
Pinzetten, Uhrmacher-	14	TAYLOR , Wundspreizer	120
PLATTFUSS , Laminektomie-Stanzen	160	TAYLOR-CUSHING , Hartmetallpinzetten TUC	20
PLESTER , Saugrohre	56	TAYLOR-SCHMIEDEN , Scheren	22
Präparierklemmen	10, 86	TOENNIS-ADSON-DELICATE , Hartmetallscheren TUC	33
		TOENNIS-OLIVECRONA , Anlegezangen	106
R		TÖNNIS , Dura Dissektoren	132
RABINER , Perkussionshämmer	58	TROEMNER , Perkussionshämmer	59
RAIMONDI , Arterienklemmen	85		
RALK , Handbohrapparate	63	U	
RANEY , Anlegezangen	107	Uhrmacherpinzetten	14
RANEY , Clips	107	UNIVERSAL , Hartmetallscheren TUC	33
RAY , Hypophysen-Instrumente	163	UNIVERSAL , Hohlmeisselzangen	74
REULEN-LANDOLT , Hypophysen-Instrumente	167		
Rhoton-Dissektoren	146,147	V	
RICHTER-SCOVILLE , Wundspreizer	121	VANNAS , Mikro-Scheren	92
RUSKIN , Hohlmeisselzangen	77,78,80	WISE , Knüpfpinzetten mit Plateau	16
RUSKIN-MINI , Hohlmeisselzangen	77		
RUSKIN-STILLE , Hohlmeisselzangen	78	W	
RYDER-MATHIEU-MICRO , Hartmetallnadelhalter TUC	39	WARTENBERG , Sensibilitäts-Instrumente	60
RYDER-MICRO , Hartmetallnadelhalter TUC	37	WEITLANER , Wundsperrerr	49
		WILLET-MARTEL , Kopfhautklemmen	8
S		Wirbelkörperspreizer	124-126
SACHS , Dura Dissektoren	133	WOOD-CRILE, BABY Hartmetallnadelhalter TUC	38
SACHS , Nervwurzelhaken	127	WOOD-CRILE , Hartmetallnadelhalter TUC	38
SAMII , Fasspinzetten	15	WULLSTEIN-MICRO , Saugrohre	56
SAMII , Mikro-Instrumente	139	Wundhaken	43-54
		Wundhaken, fein	44,45

Wundsperrer, selbsthaltend
Wundspreizer
Wundspreizer Wirbelsäule

48-53
116-123
116-118

Z

Zangen, Laminektomie-
ZAUFAL-JANSEN, Hohlmeisselzangen

154-157
77

Index

	Page		Page
A			
Adapter	176	CONE , retractors	51
ADSON , dissecting forceps tungsten TUC	20	Connection cords	170
ADSON , dressing forceps	12	CONVERSE , needle holders tungsten TUC	37
ADSON , dura hooks	131	COTTLE , chisels	162
ADSON , elevators	73	COTTLE , mallets	69
ADSON , retractors	50	Cranial rongeurs	99
ADSON , suction tubes	56	CRILE-WOOD , needle holders tungsten TUC	38
ADSON-ANDERSON , retractors	49	CRILE-WOOD-BABY , needle holders tungsten TUC	38
ADSON-BABY , artery forceps	9	CRUTCHFIELD , cervical traction tongs	100
ADSON-BECKMANN , retractors	52	CUSHING , delicate hooks	45
ADSON-BROWN , dressing forceps	12	CUSHING , dissecting forceps tungsten TUC	20
ALM , retractors	48	CUSHING , dressing forceps	13
ALY , sensibility instruments	60	CUSHING , dura hooks	131
ANDERSON-ADSON , retractors	49	CUSHING , laminectomy punches	154
Aneurysm- and vessel clips	109-111	CUSHING , spinal retractors	46
Applying forceps	105-107	CUSHING , tissue forceps	13
Applying forceps for aneurysm clips	112,113	CUSHING-LANDOLT , specula for hypophysectomy	162
Artery forceps	9,85	CUSHING-TAYLOR , dissecting forceps tungsten TUC	20
AUSTIN , suture tying forceps with platform	16	D	
B			
BABINSKY , percussion hammers	58	DAHLGREEN , cranial rongeurs	99
BABY-ADSON , artery forceps	9	DAHMEN , chisels	68
BABY-CRILE-WOOD , needle holders tungsten TUC	38	DAHMEN , osteotomes	68
BABY-MIXTER , dissecting forceps	10	DANDY , dissecting forceps	10
BABY-OVERHOLT , artery forceps	9	DANDY , nerve hooks	129
BACON , bone rongeurs	76	DANDY , scissors	22
BARRAQUER , micro needle holders	94	DAVIS , dura dissectors	132
BECKMANN , retractors	51	DE BAKEY , needle holders tungsten TUC	36
BECKMANN-ADSON , retractors	52	DE BAKEY , non-traumatic forceps	19
BECKMANN-EATON , retractors	52	DE VILBISS , cranial rongeurs	99
BELLUCCI , micro instruments	148	DÉJERINE , percussion hammers	59
BERLINER , percussion hammers	59	Delicate hooks	44,45
BEYER , bone rongeurs	77	DIETHRICH , micro forceps	90
BIEMER , nerve hooks	130	Dissectomy retractors	114,115
BLUMENTHAL , bone rongeurs	75	Dissecting forceps	10,86
BÖHLER , bone rongeurs	77	Dissecting forceps tungsten TUC	20
Bone curettes	71	Dressing forceps	12,13
Bone rongeurs	74-80	Dura dissectors	132-135
Brain retractor	101-103	Dura hooks	131
Brain spatulas	104	E	
BROWN-ADSON , dressing forceps	12	EasyClean laminectomy rongeurs	151,152
BUCK , percussion hammers	58	EATON-BECKMANN , retractors	52
C			
CASPAR , cervical retractors	116,118	ECHLIN , bone rongeurs	79
CASPAR , laminectomy rongeurs	156	Elevators	72,73
CASPAR , micro instruments	137,138,143	F	
CASPAR , retractors	119	FAHLBUSCH , micro instruments	148
CASTROVIEJO , needle holders tungsten TUC	40	FAHLBUSCH , pituitary instruments	165
Cervical retractors	116-118	FERGUSSON , suction tubes	56
Cervical traction tongs	100	FERRIS-SMITH , laminectomy punches	158
Chisels	66-68	FERRIS-SMITH-CUSHING , laminectomy rongeurs	157
CLEVELAND , bone rongeurs	74	Fibre optic cable	175
Clip carrier	107	FISCH , nerve hooks	130
Clips	105,107,109-111	Forceps	11-20,89-90
CLOWARD , bone curettes	71	Forceps, applying	105-107
CLOWARD , lamina spreaders	122,124	Forceps, artery	9,85
CLOWARD , laminectomy rongeurs	156	Forceps, BI-coagulation	171
CLOWARD modif., retractors	122	Forceps, dissecting	10,86
Coagulation forceps, bipolar	171	Forceps, dissecting tungsten TUC	20
Cold light sources	177,178	Forceps, dressing	12,13
Conductors for wire saws	98	Forceps, grasping	15
		Forceps, Jeweler's	14
		Forceps, micro	16-18,88-90

	Page		Page
Forceps, non-traumatic	19	KOOS , micro instruments	141
Forceps, scalp flap	8	KRAUS , micro instruments	142
Forceps, suture	89	KRAYENBÜHL , nerve hooks	130
Forceps, suture tying	16,17		
Forceps, tungsten TUC	20	L	
FRAZIER , delicate hooks	44	Lamina spreaders	124-126
FRAZIER , dura dissectors	133	Laminectomy punches	150-153,158-160
FRAZIER , suction tubes	56	Laminectomy rongeurs	154-157
FREER , elevators	72	LANDOLT , pituitary instruments	166
FRIEDMAN , bone rongeurs	74	LANDOLT , pituitary rongeurs	161
FRIEDMAN-MINI , bone rongeurs	74	LANDOLT , spreader	162
FRYKHOLM , bone rongeurs	79	LANDOLT-REULEN , pituitary instruments	167
		LANGENBECK , elevators	72
G		LANGENBECK , needle holders tungsten TUC	39
Galea hooks	108	LEMPERT , bone rongeurs	76
GEMINI , dissecting forceps	10	LEXER , chisels	66,67
GILLIES , delicate hooks	44	LEXER , osteotomes	67
GOLDMAN-FOX , scissors tungsten TUC	33	LEXER , scissors tungsten TUC	31
Gouges	66-68	LEXER-MINI , chisels	66
GRAHAM , dura hooks	131	LEYLA , brain retractor	101-103
Grasping forceps	15	LOVE-GRUENWALD , laminectomy punches	154
GRONINGEN , nerve hooks	129	LOVE , nerve root retractors	128
		LOVE modif., nerve root retractors	128
H		LUER , bone rongeurs	75
HAJEK-KOFFLER , laminectomy punches	159		
HALSEY , needle holders tungsten TUC	37	M	
Hammers, percussion	58,59	Mallets	58,59,69,70
Hand drills	62,63	MARQUARDT , bone rongeurs	76
Handles for wire saws	98	MARTEL , conductors for wire saws	98
HARDY , pituitary instruments	163,165	MARTEL , scalp flap forceps	8
HARDY-FAHLBUSCH , pituitary instruments	165	MARTIN , nerve root retractors	128
HARMS , lamina spreaders	125	MATHIEU , needle holders tungsten TUC	39
HARTMANN , bone rongeurs	75	MATHIEU-DELICATE , needle holders tungsten TUC	39
HEIFETZ , brain spatulas	104	MATHIEU-RYDER-MICRO , needle holders tungsten TUC	39
HEIFETZ , grasping forceps	15	MAYFIELD , bone rongeurs	76
HEY , discectomy retractors	114	MAYO , scissors tungsten TUC	29
HIBBS SPRATT , bone curettes	71	MAYO-HEGAR , needle holders tungsten TUC	36
High frequency cord	178	MAYO-HEGAR-DELICATE , needle holders tungsten TUC	36
HOEN , artery forceps	85	MC KENZIE , applying forceps	106
HOEN , dura dissectors	133	MC KENZIE , clip carrier	107
HOEN , elevators	73	MEAD , bone rongeurs	75
Hooks, dura	131	METZENBAUM , scissors tungsten TUC	29-32
Hooks, nerve	129,13	METZENBAUM-DELICATE , scissors tungsten TUC	31,32
HORSLEY , nerve root retractors	127	MEYERDING , retractors	47
HOSOBUCHI , pituitary instruments	167	MICRO-ADSON , dressing forceps	12
HUNT , grasping forceps	15	MICRO-MOSQUITO , artery forceps	9
		MICRO-RYDER , needle holders tungsten TUC	37
I		Micro forceps	16-18,88-90
INGE , lamina spreaders	126	Micro instruments	87,136-145,148,149
Instruments for cranial opening	98,99	Micro needle holders	41,42,94
		Micro scissors	23-28,91-93
J		MILLES , micro scissors	92
JACOBSON , micro-needle holders	42	MILLIGAN , dura dissectors	134
JACOBSON , micro instruments	143	MINI , applying forceps for aneurysm clips	113
JACOBSON , needle holders tungsten TUC	40	MINI-FRIEDMAN , bone rongeurs	74
JANSEN , retractors	48	MINI-LEXER , chisels	66
JANSEN-ZAUFAL , bone rongeurs	77	MINI-RUSKIN , bone rongeurs	77
Jeweler's forceps	14	MIXTER-BABY , dissecting forceps	10
		MOLDESTAD , delicate hooks	45
K			
KERRISON , laminectomy punches	150,159	N	
KERRISON-COLCLOUGH , laminectomy punches	153	NAGEL , micro scissors	91
KILNER , delicate hooks	44	Needle holders	35-42,94-97
KLEINERT-KUTZ , bone rongeurs	77	Needle holders, micro	41,42,94
KLEINERT-KUTZ , delicate hooks	44	Needle holders, tungsten TUC	36-40
KÖLNER , clips	107	NEIVERT , needle holders tungsten TUC	37
		Nerve dissecting scissors	22
		Nerve hooks	129,130

	Page		Page
Nerve root retractors	127	STANDARD , applying forceps for aneurysm clips	113
NICOLA , micro instruments	149	STANDARD , scissors tungsten TUC	29
NICOLA , pituitary instruments	164	STELLBRINK , bone rongeurs	74
Non-traumatic tissue forceps	19	STILLE , bone rongeurs	78
O		STILLE , hand drills	62
OKONEK-YASARGIL , micro instruments	144	STILLE-RUSKIN , bone rongeurs	78
OLDBERG , laminectomy rongeurs	157	STRULLY , scissors	22
OLIVECRONA , brain spatulas	104	Suction tubes	56
OLIVECRONA , dura dissectors	134	Suture forceps	89
OLIVECRONA , scissors	22	Suture tying forceps with platform	16,17
OLIVECRONA-GIGLI , wire saws	98	T	
OLIVECRONA-TOENNIS , applying forceps	106	TAYLOR , percussion hammers	58
OMBREDANNE , mallets	69	TAYLOR , retractors	120
Osteotomes	66,67	TAYLOR , spinal retractors	46
OVERHOLT-BABY , artery forceps	9	TOENNIS-ADSON-DELICATE , scissors tungsten TUC	33
P		TÖNNIS , dura dissectors	132
PENFIELD , dura dissectors	135	TROEMNER , percussion hammers	59
Percussion hammers	58,59	Tubes, suction	56
Pituitary instruments	161-167	U	
Pituitary rongeurs	161	UNIVERSAL , bone rongeurs	74
PLATTFUSS , laminectomy punches	160	UNIVERSAL , scissors tungsten TUC	33
PLESTER , suction tubes	56	V	
R		VANNAS , micro scissors	92
RABINER , percussion hammers	58	Vessel- and aneurysm clips	109-111
RAIMONDI , artery forceps	85	W	
RALK , hand drills	63	WARTENBERG , sensibility instruments	60
RANEY , applying forceps	107	WEITLANER , retractors	49
RANEY , clips	107	WILLET-MARTEL , scalp flap forceps	8
RAY , pituitary instruments	163	Wire saws	98
Retractors	43-54	WULLSTEIN-MICRO , suction tubes	56
Retractors	116-123	Z	
Retractors, cervical	116-118	ZAUFAL-JANSEN , bone rongeurs	77
Retractors, selfretaining	48-53		
RUSKIN , bone rongeurs	77,78,80		
RUSKIN-MINI , bone rongeurs	77		
S			
SACHS , dura dissectors	133		
SACHS , nerve root retractors	127		
SAMII , grasping forceps	15		
SAMII , micro instruments	139		
SCALP-CONTOUR , retractors	53		
Scalp flap forceps	8		
SCHLESINGER , laminectomy rongeurs	155		
SCHMIEDEN-TAYLOR , scissors	22		
Scissors	21-34,91-93		
Scissors, micro	23-28,91-93		
Scissors, tungsten TUC	29-33		
SCOVILLE , nerve root retractors	127		
SCOVILLE , retractors	120		
SCOVILLE-HAVERFIELD , retractors	120		
SCOVILLE-RICHTER , retractors	121		
Selfretaining retractors	48-53		
SELVERSTONE , laminectomy rongeurs	155		
SEMB , bone rongeurs	78		
Sensibility instruments	60		
SMITH-PETERSON , bone rongeurs	80		
SMITHWICK , nerve hooks	129		
SNITMAN , retractors	48		
Specula for hypophysectomy	162		
SPINAL FUSION , bone curettes	71		
Spinal retractors	46		
Spreader for hypophysectomy	162		
SPURLING , laminectomy punches	154		

Índice alfabético

	Página		Página
A			
Adaptador	176		
ADSON , elevadores	73		
ADSON , ganchos para dura-madre	131		
ADSON , pinzas de disección	12		
ADSON , pinzas de disección tungsteno TUC	20		
ADSON , separadores	50		
ADSON , tubos de aspiración	56		
ADSON-BROWN , pinzas de disección	12		
ALM , separadores	48		
ALY , instrumentos sensibilidad	60		
ANDERSON-ADSON , separadores	49		
AUSTIN , pinzas de ligadura con plataforma	16		
B			
BABINSKY , martillos de percusión	58		
BABY-ADSON , pinzas hemostáticas	9		
BABY-CRILE-WOOD , porta-agujas tungsteno TUC	38		
BABY-MIXTER , pinzas para preparaciones	10		
BABY-OVERHOLT , pinzas hemostáticas	9		
BACON , pinzas-gubias	76		
BARRAQUER , micro-porta-agujas	94		
BECKMANN , separadores	51		
BECKMANN-ADSON , separadores	52		
BECKMANN-EATON , separadores	52		
BELLUCCI , instrumentos para microcirugía	148		
BERLINER , martillos de percusión	59		
BEYER , pinzas-gubias	77		
BIEMER , ganchos para nervios	130		
BLUMENTHAL , pinzas-gubias	75		
BÖHLER , pinzas-gubias	77		
BUCK , martillos de percusión	58		
C			
Cables de conexión	170		
Cables fibra óptica	175		
CASPAR , instrumentos para microcirugía	137,138,143		
CASPAR , pinzas cortantes para laminectomía	156		
CASPAR , separadores	119		
CASPAR , separadores vertebrales	116,118		
CASTROVIEJO , porta-agujas tungsteno TUC	40		
Cinceles	66-68		
CLEVELAND , pinzas-gubias	74		
Clips	105,107,109-111		
Clips de aneurisma	109-111		
CLOWARD , cucharillas cortantes	71		
CLOWARD , pinzas cortantes para laminectomía	156		
CLOWARD , separadores para cuerpos vertebrales	122,124		
CLOWARD modif., separadores	122		
CONE , separadores	51		
CONVERSE , porta-agujas tungsteno TUC	37		
COTTLE , cinceles	162		
COTTLE , martillos	69		
CRILE-WOOD , porta-agujas tungsteno TUC	38		
CRUTCHFIELD , pinzas de tracción craneal	100		
Cucharillas cortantes	71		
CUSHING , ganchos	45		
CUSHING , ganchos para dura-madre	131		
CUSHING , pinzas cortantes para laminectomía	154		
CUSHING , pinzas de disección	13		
CUSHING , pinzas de disección tungsteno TUC	20		
CUSHING , separadores espinales	46		
CUSHING-LANDOLT , espéculos para hipófisis	162		
CUSHING-TAYLOR , pinzas de disección tungsteno TUC	20		
D			
DAHLGREEN , pinzas craneal	99		
DAHMEN , cinceles	68		
DAHMEN , osteotomos	68		
DANDY , ganchos para nervios	129		
DANDY , pinzas para preparaciones	10		
DANDY , tijeras	22		
DAVIS , disecadores para dura-madre	132		
DE BAKEY , pinzas atrauma	19		
DE BAKEY , porta-agujas tungsteno TUC	36		
DE VILBISS , pinzas craneal	99		
DÉJERINE , martillos de percusión	59		
DIETHRICH , micro-pinzas	90		
Disecadores para dura-madre	132-135		
E			
EasyClean pinzas cortantes para discos intervertebrales	151,152		
ECHLIN , pinzas-gubias	79		
Elevadores	72,73		
Espátulas cerebrales	104		
Espéculos para hipófisis	162		
F			
FAHLBUSCH , instrumentos para hipófisis	165		
FAHLBUSCH , instrumentos para microcirugía	148		
FERGUSSON , tubos de aspiración	56		
FERRIS-SMITH , pinzas cortantes para discos intervertebrales	158		
FERRIS-SMITH-CUSHING , pinzas cortantes para laminectomía	157		
FISCH , ganchos para nervios	130		
FRAZIER , disecadores para dura-madre	133		
FRAZIER , ganchos	44		
FRAZIER , tubos de aspiración	56		
FREER , elevadores	72		
FRIEDMAN , pinzas-gubias	74		
FRIEDMAN-MINI , pinzas-gubias	74		
FRYKHOLM , pinzas-gubias	79		
Fuente de luz fría	177,178		
G			
Ganchos	44,45		
Ganchos para dura-madre	131		
Ganchos para galea	108		
Ganchos para nervios	129,130		
GEMINI , pinzas para preparaciones	10		
GILLIES , ganchos	44		
GOLDMAN-FOX , tijeras tungsteno TUC	33		
GRAHAM , ganchos para dura-madre	131		
GRONINGEN , ganchos para nervios	129		
Gubias	66-68		
H			
HAJEK-KOFFLER , pinzas cortantes para discos intervertebrales	159		
HALSEY , porta-agujas tungsteno TUC	37		
HARDY , instrumentos para hipófisis	163,165		
HARDY-FAHLBUSCH , instrumentos para hipófisis	165		
HARMS , separadores para cuerpos vertebrales	125		
HARTMANN , pinzas-gubias	75		
HEIFETZ , espátulas cerebrales	104		
HEIFETZ , pinzas para coger	15		
HEY , separadores para músculos	114		
HIBBS SPRATT , cucharillas cortantes	71		
HOEN , disecadores para dura-madre	133		

	Página		Página
HOEN , elevadores	73	METZENBAUM , tijeras tungsteno TUC	29-32
HOEN , pinzas hemostáticas	85	METZENBAUM-DELICATE , tijeras tungsteno TUC	31,32
HORSLEY , separadores de raíz de nervios	127	MEYERDING , separadores	47
HOSOBUCHI , instrumentos para hipófisis	167	MICRO-ADSON , pinzas de disección	12
HUNT , pinzas para coger	15	MICRO-MOSQUITO , pinzas hemostáticas	9
I		Micro-pinzas	16-18,88-90
INGE , separadores para cuerpos vertebrales	126	Micro-porta-agujas	41,42,94
Instrumentos para abertura craneana	98,99	MICRO-RYDER , porta-agujas tungsteno TUC	37
Instrumentos para hipófisis	161-167	Micro-tijeras	23-28,91-93
Instrumentos para microcirugía	87,136-145,148,149	MILLES , micro-tijeras	92
Instrumentos sensibilidad	60	MILLIGAN , disecadores para dura-madre	134
J		MINI , pinzas para juntar clips de aneurisma	113
JACOBSON , instrumentos para microcirugía	143	MINI-FRIEDMAN , pinzas-gubias	74
JACOBSON , micro-porta-agujas	42	MINI-LEXER , cinceles	66
JACOBSON , porta-agujas tungsteno TUC	40	MINI-RUSKIN , pinzas-gubias	77
JANSEN , separadores	48	MOLDESTAD , ganchos	45
K		N	
KERRISON , pinzas cortantes para discos intervertebrales	150,159	NAGEL , micro-tijeras	91
KERRISON-COLCLOUGH , pinzas para discos intervertebrales	153	NEIVERT , porta-agujas tungsteno TUC	37
KILNER , ganchos	44	NICOLA , instrumentos para hipófisis	164
KLEINERT-KUTZ , ganchos	44	NICOLA , instrumentos para microcirugía	149
KLEINERT-KUTZ , pinzas-gubias	77	O	
KÖLNER , clips	107	OKONEK , instrumentos para microcirugía	144
KOOS , instrumentos para microcirugía	141	OLDBERG , pinzas cortantes para laminectomía	157
KRAUS , instrumentos para microcirugía	142	OLIVECRONA , disecadores para dura-madre	134
KRAYENBÜHL , ganchos para nervios	130	OLIVECRONA , espátulas cerebrales	104
L		OLIVECRONA , tijeras	22
LANDOLT , instrumentos para hipófisis	166	OLIVECRONA-GIGLI , sierras de hilos	98
LANDOLT , pinzas cortantes para hipófisis	161	OLIVECRONA-TOENNIS , pinzas aplicadoras	106
LANDOLT , separador para hipófisis	162	OMBREDANNE , martillos	69
LANDOLT-REULEN , instrumentos para hipófisis	167	Osteotomes	66,67
LANGENBECK , elevadores	72	P	
LANGENBECK , porta-agujas tungsteno TUC	39	PENFIELD , disecadores para dura-madre	135
LEMPERT , pinzas-gubias	76	Perforadores de mano	62,63
LEXER , cinceles	66,67	Pinzas	11-20-,89,90
LEXER , osteotomes	67	Pinzas aplicadoras	105-107
LEXER , tijeras tungsteno TUC	31	Pinzas atrauma	19
LEXER-MINI , cinceles	66	Pinzas cortantes para discos intervertebrales	150-153,158-160
LEYLA , separadores cerebrales	101-103	Pinzas cortantes para hipófisis	161
LOVE-GRUENWALD , pinzas para discos intervertebrales	154	Pinzas cortantes para laminectomía	154-157
LOVE , separadores de raíz de nervios	128	Pinzas craneal	99
LOVE modif. , separadores de raíz de nervios	128	Pinzas de ligadura con plataforma	16,17
LUER , pinzas-gubias	75	Pinzas de relojero	14
M		Pinzas de tracción craneal	100
Mango maciza	98	Pinzas-gubias	74-80
MARQUARDT , pinzas-gubias	76	Pinzas hemostáticas	9,85
MARTEL , pinzas para pericráneo	8	Pinzas hemostáticas para pericráneo	8
MARTEL , sonda conductora	98	Pinzas micro	16-18,88-90
Martillos	58,59,69,70	Pinzas para coger	15
Martillos de percusión	58,59	Pinzas para juntar clips de aneurisma	112,113
MARTIN , separadores de raíz de nervios	128	Pinzas para la BI-Coagulación	171
MATHIEU , porta-agujas tungsteno TUC	39	Pinzas para preparaciones	10,86
MATHIEU-DELICATE , porta-agujas tungsteno TUC	39	Pinzas para sutura	89
MATHIEU-RYDER-MICRO , porta-agujas tungsteno TUC	39	Pinzas, tungsteno TUC	20
MAYFIELD , pinzas-gubias	76	PLATTFUSS , pinzas cortantes para discos intervertebrales	160
MAYO , tijeras tungsteno TUC	29	PLESTER , tubos de aspiración	56
MAYO-HEGAR , porta-agujas tungsteno TUC	36	Porta-agujas	36-42,94-97
MAYO-HEGAR-DELICATE , porta-agujas tungsteno TUC	36	Porta-agujas, micro	41,42,94
MC KENZIE , pinzas aplicadoras	106	Porta-agujas, tungsteno TUC	36-40
MC KENZIE , soporte de grapas	107	R	
MEAD , pinzas-gubias	75	RABINER , martillos de percusión	58
		RAIMONDI , pinzas hemostáticas	85
		RALK , perforadores de mano	63

	Página		Página
RANEY , clips	107	W	
RANEY , pinzas aplicadoras	107	WARTENBERG , instrumentos sensibilidad	60
RAY , instrumentos para hipófisis	163	WEITLANER , separadores	49
RUSKIN , pinzas-gubias	77,78,80	WILLET-MARTEL , pinzas para pericráneo	8
RUSKIN-MINI , pinzas-gubias	77	WULLSTEIN-MICRO , tubos de aspiración	56
S		Z	
SACHS , disecadores para dura-madre	133	ZAUFAL-JANSEN , pinzas-gubias	77
SACHS , separadores de raiz de nervios	127		
SAMII , instrumentos para microcirugía	139		
SAMII , pinzas para coger	15		
SCALP-CONTOUR , separadores	53		
SCHLESINGER , pinzas cortantes para laminectomía	155		
SCHMIEDEN-TAYLOR , tijeras	22		
SCOVILLE , separadores	106		
SCOVILLE , separadores de raiz de nervios	127		
SCOVILLE-HAVERFIELD , separadores	120		
SCOVILLE-RICHTER , separadores	121		
SELVERSTONE , pinzas cortantes para laminectomía	155		
SEMB , pinzas-gubias	78		
Separadores	44-53,114-128		
Separadores autoestaticos	48-53		
Separadores cerebrales	101-103		
Separadores de raiz de nervios	127,128		
Separadores espinales	46		
Separadores para cuerpos vertebrales	124-126		
Separadores para hipófisis	162		
Separadores para músculos	114,115		
Separadores vertebrales	116-118		
Sierras de hilos	98		
SMITH-PETERSON , pinzas-gubias	80		
SMITHWICK , ganchos para nervios	129		
SNITMAN , separadores	48		
Sonda conductora	98		
Soporte de grapas	107		
SPINAL FUSION , cucharillas cortantes	71		
SPURLING , pinzas cortantes para discos intervertebrales	154		
STANDARD , pinzas para juntar clips de aneurysma	113		
STANDARD , tijeras tungsteno TUC	29		
STELLBRINK , pinzas-gubias	74		
STILLE , perforadores de mano	62		
STILLE , pinzas-gubias	78		
STILLE-RUSKIN , pinzas-gubias	78		
STRULLY , tijeras	22		
T			
TAYLOR , martillos de percusión	58		
TAYLOR , separadores	120		
TAYLOR , separadores espinales	46		
Tijeras	21-34,91-93		
Tijeras micro	23-28,91-93		
Tijeras para nervios	22		
Tijeras, tungsteno TUC	29-33		
TOENNIS-ADSON-DELICATE , tijeras tungsteno TUC	33		
TÖNNIS , disecadores para dura-madre	132		
TROEMNER , martillos de percusión	59		
Tubos de aspiración	56		
U			
UNIVERSAL , pinzas-gubias	74		
UNIVERSAL , tijeras tungsteno TUC	33		
V			
VANNAS , micro-tijeras	92		

Index

	Page		Page
A			
ADSON , canules d'aspiration	56	Crochets très fins	44,45
ADSON , crochets à dure-mère	131	CRUTCHFIELD , pinces de traction crânienne	100
ADSON , écarteurs	50	Curettes tranchantes	71
ADSON , élévateurs	73	CUSHING , crochets à dure-mère	131
ADSON , pinces à dissection	12	CUSHING , crochets très fins	45
ADSON , pinces à dissection tungstène TUC	20	CUSHING , écarteurs spinals	46
ADSON-BROWN , pinces à dissection	12	CUSHING , pinces à dissection	13
ALM , écarteurs	48	CUSHING , pinces à dissection tungstène TUC	20
ALY , instruments sensibilités	60	CUSHING , pinces pour lames intervertébrales	154
ANDERSON-ADSON , écarteurs	49	CUSHING-LANDOLT , spéculums pour la chirurgie pituitaire	162
AUSTIN , pinces à ligature avec plate-forme	16	CUSHING-TAYLOR , pinces à dissection tungstène TUC	20
B			
BABINSKY , marteaux-percuteurs	58	D	
BABY-ADSON , pinces hémostatiques	9	DAHLGREEN , pinces pour crâne	99
BABY-CRILE-WOOD , porte-aiguilles tungstène TUC	38	DAHMEN , ciseaux-burins	68
BABY-MIXTER , pinces à dissection	10	DAHMEN , ostéotomes	68
BABY-OVERHOLT , pinces hémostatiques	9	DANDY , ciseaux	22
BACON , pinces-gouges	76	DANDY , crochets à nerfs	129
BARRAQUER , micro-porte-aiguilles	94	DANDY , pinces à dissection	10
BECKMANN , écarteurs	51	DAVIS , dissecteurs à dure-mère	132
BECKMANN-ADSON , écarteurs	52	DE BAKEY , pinces atrauma	19
BECKMANN-EATON , écarteurs	52	DE BAKEY , porte-aiguilles tungstène TUC	36
BELLUCCI , instruments pour la chirurgie micro	148	DE VILBISS , pinces pour crâne	99
BERLINER , marteaux-percuteurs	59	DÉJERINE , marteaux-percuteurs	59
BEYER , pinces-gouges	77	DIETHRICH , micro-pinces	90
BIEMER , crochets à nerfs	130	Dissecteurs à dure-mère	132-135
BLUMENTHAL , pinces-gouges	75	E	
BÖHLER , pinces-gouges	77	EasyClean pinces emporte-pièces à laminectomie	151,152
BUCK , marteaux-percuteurs	58	Écarteurs	44-53,114-128
C			
Câbles de raccordement	170	Écarteurs autostatiques	48-53
Câbles fibre optique	175	Écarteurs cérébrales	101-103
Canules d'aspiration	56	Écarteurs cervicales	116-118
CASPAR , écarteurs	119	Écarteurs musculaire	114,115
CASPAR , écarteurs cervicales	116,118	Écarteurs pour corps vertébraux	124-126
CASPAR , instruments pour la chirurgie micro	137,138,143	Écarteurs pour la chirurgie pituitaire	162
CASPAR , pinces emporte-pièces à laminectomie	156	Écarteurs spinals	46
CASTROVIEJO , porte-aiguilles tungstène TUC	40	ECHLIN , pinces-gouges	79
Ciseaux	21-34,91-93	Élévateurs	72,73
Ciseaux-burins	66-68	F	
Ciseaux micro	23-28,91-93	FAHLBUSCH , instruments pour la chirurgie micro	148
Ciseaux pour nerfs	22	FAHLBUSCH , instruments pour la chirurgie pituitaire	165
Ciseaux, tungstène TUC	29-33	FERGUSSON , canules d'aspiration	56
CLEVELAND , pinces-gouges	74	FERRIS-SMITH , pinces pour lames intervertébrales	158
Clips	105,107,109-111	FERRIS-SMITH-CUSHING , pinces emporte-pièces à laminectomie	157
Clips pour aneurisme	109-111	Fils scies	98
CLOWARD , curettes tranchantes	71	FISCH , crochets à nerfs	130
CLOWARD , écarteurs pour corps vertébraux	122,124	FRAZIER , canules d'aspiration	56
CLOWARD , pinces emporte-pièces à laminectomie	156	FRAZIER , crochets très fins	44
CLOWARD modif., écarteurs	122	FRAZIER , dissecteurs à dure-mère	133
Conducteurs pour fils scies	98	FREER , élévateurs	72
CONE , écarteurs	51	FRIEDMAN , pinces-gouges	74
Connexion	176	FRIEDMAN-MINI , pinces-gouges	74
CONVERSE , porte-aiguilles tungstène TUC	37	FRYKHOLM , pinces-gouges	79
COTTLE , ciseaux-burins	162	G	
COTTLE , marteaux	69	GEMINI , pinces à dissection	10
CRILE-WOOD , porte-aiguilles tungstène TUC	38	GILLIES , crochets très fins	44
Crochets à dure-mère	131	GOLDMAN-FOX , ciseaux tungstène TUC	33
Crochets à galea	108	GRAHAM , crochets à dure-mère	131
Crochets à nerfs	129,130	GRONINGEN , crochets à nerfs	129
Crochets pour fils scies	98		

H

HAJEK-KOFFLER , pinces pour lames intervertébrales	159
HALSEY , porte-aiguilles tungstène TUC	37
HARDY , instruments pour la chirurgie pituitaire	163,165
HARDY-FAHLBUSCH , instruments pour la chirurgie pituitaire	165
HARMS , écarteurs pour corps vertébraux	125
HARTMANN , pinces-gouges	75
HEIFETZ , pinces pour saisir les tissus	15
HEIFETZ , spatules cérébrales	104
HEY , écarteurs musculaire	114
HIBBS SPRATT , curettes tranchantes	71
HOEN , dissecteurs à dure-mère	133
HOEN , élévateurs	73
HOEN , pinces hémostatiques	85
HORSLEY , rétracteurs pour racines nerveuses	127
HOSOBUCHI , instruments pour la chirurgie pituitaire	167
HUNT , pinces pour saisir les tissus	15

I

INGE , écarteurs pour corps vertébraux	126
Instruments pour la chirurgie micro	87,136-145,148,149
Instruments pour la chirurgie pituitaire	161-167
Instruments pour l'ouverture du crâne	98,99
Instruments sensibilités	60

J

JACOBSON , instruments pour la chirurgie micro	143
JACOBSON , micro-porte-aiguilles	42
JACOBSON , porte-aiguilles tungstène TUC	40
JANSEN , écarteurs	48

K

KERRISON , pinces pour lames intervertébrales	150,159
KERRISON-COLCLOUGH , pinces pour lames intervertébrales	153
KILNER , crochets très fins	44
KLEINERT-KUTZ , crochets très fins	44
KLEINERT-KUTZ , pinces-gouges	77
KÖLNER , clips	107
KOOS , instruments pour la chirurgie micro	141
KRAUS , instruments pour la chirurgie micro	142
KRAYENBÜHL , crochets à nerfs	130

L

LANDOLT , écarteur pour la chirurgie pituitaire	162
LANDOLT , instruments pour la chirurgie pituitaire	166
LANDOLT , pinces emporte-pièces pour la chirurgie pituitaire	161
LANDOLT-REULEN , instruments pour la chirurgie pituitaire	167
LANGENBECK , élévateurs	72
LANGENBECK , porte-aiguilles tungstène TUC	39
LEMPERT , pinces-gouges	76
LEXER , ciseaux-burins	66,67
LEXER , ciseaux tungstène TUC	31
LEXER , ostéotomes	67
LEXER-MINI , ciseaux-burins	66
LEYLA , écarteurs cérébrales	101,103
LOVE-GRUENWALD , pinces pour lames intervertébrales	154
LOVE , rétracteurs pour racines nerveuses	128
LOVE modif. , rétracteurs pour racines nerveuses	128
LUER , pinces-gouges	75

M

MARQUARDT , pinces-gouges	76
Marteaux	58,59,69,70
Marteaux-percuteurs	58,59
MARTEL , conducteurs pour fils scies	98

MARTEL , pinces pour le cuir chevelu	8
MARTIN , rétracteurs pour racines nerveuses	128
MATHIEU , porte-aiguilles tungstène TUC	39
MATHIEU-DELICATE , porte-aiguilles tungstène TUC	39
MATHIEU-RYDER-MICRO , porte-aiguilles tungstène TUC	39
MAYFIELD , pinces-gouges	76
MAYO , ciseaux tungstène TUC	29
MAYO-HEGAR , porte-aiguilles tungstène TUC	36
MAYO-HEGAR-DELICATE , porte-aiguilles tungstène TUC	36
MC KENZIE , pinces pour le cuir chevelu	106
MC KENZIE , support pour le cuir chevelu	107
MEAD , pinces-gouges	75
METZENBAUM , ciseaux tungstène TUC	29-32
METZENBAUM-DELICATE , ciseaux tungstène TUC	31,32
MEYERDING , écarteurs	47
MICRO-ADSON , pinces à dissection	12
Micro-ciseaux	23-28,91-93
MICRO-MOSQUITO , pinces hémostatiques	9
Micro-pinces	16-18,88-90
Micro-porte-aiguilles	41,42,94
MICRO-RYDER , porte-aiguilles tungstène TUC	37
MILLES , micro-ciseaux	92
MILLIGAN , dissecteurs à dure-mère	134
MINI , pinces pour poser les clips d'anéurisme	113
MINI-FRIEDMAN , pinces-gouges	74
MINI-LEXER , ciseaux-burins	66
MINI-RUSKIN , pinces-gouges	77
MOLDESTAD , crochets très fins	45

N

NAGEL , micro-ciseaux	91
NEIVERT , porte-aiguilles tungstène TUC	37
NICOLA , instruments pour la chirurgie micro	149
NICOLA , instruments pour la chirurgie pituitaire	164

O

OKONEK , instruments pour la chirurgie micro	144
OLDBERG , pinces emporte-pièces à laminectomie	157
OLIVECRONA , ciseaux	22
OLIVECRONA , dissecteurs à dure-mère	134
OLIVECRONA , spatules cérébrales	104
OLIVECRONA-GIGLI , fils scies	98
OLIVECRONA-TOENNIS , pinces pour le cuir chevelu	106
OMBREDANNE , marteaux	69
Ostéotomes	66-68

P

PENFIELD , dissecteurs à dure-mère	135
Perforateurs à main	62,63
Pinces	11-20,89,90
Pinces à dissection	10,86
Pinces à ligature avec plate-forme	16,17
Pinces atrauma	19
Pinces d'horloger	14
Pinces de traction crânienne	100
Pinces emporte-pièces à laminectomie	154-157
Pinces emporte-pièces pour la chirurgie pituitaire	161
Pinces-gouges	74-80
Pinces hémostatiques	9,85
Pinces hémostatiques pour le cuir chevelu	8
Pinces micro	16-18,88-90
Pinces pour crâne	99
Pinces pour la BI-Coagulation	171
Pinces pour lames intervertébrales	150-153,158-160
Pinces pour le cuir chevelu	105-107
Pinces pour poser les clips d'anéurisme	112,113
Pinces pour saisir les tissus	15
Pinces pour sutures	89

	Page		Page
Pinces, tungstène TUC	20	W	
PLATTFUSS , pinces pour lames intervertébrales	160	WARTENBERG , instruments sensibilités	60
PLESTER , canules d'aspiration	56	WEITLANER , écarteurs	49
Porte-aiguilles	36-42,94-97	WILLET-MARTEL , pinces pour le cuir chevelu	8
Porte-aiguilles, micro	41,42,94	WULLSTEIN-MICRO , canules d'aspiration	56
Porte-aiguilles, tungstène TUC	36-40	Z	
R		ZAUFAL-JANSEN , pinces-gouges	77
RABINER , marteaux-percuteurs	58		
RAIMONDI , pinces hémostatiques	85		
RALK , perforateurs à main	63		
RANEY , clips	107		
RANEY , pinces pour le cuir chevelu	107		
RAY , instruments pour la chirurgie pituitaire	163		
Rétracteurs pour racines nerveuses	127,128		
RUSKIN , pinces-gouges	77,78,80		
RUSKIN-MINI , pinces-gouges	77		
S			
SACHS , dissecteurs à dure-mère	133		
SACHS , rétracteurs pour racines nerveuses	127		
SAMII , instruments pour la chirurgie micro	139		
SAMII , pinces pour saisir les tissus	15		
SCALP-CONTOUR , écarteurs	53		
SCHLESINGER , pinces emporte-pièces à laminectomie	155		
SCHMIEDEN-TAYLOR , ciseaux	22		
SCOVILLE , écarteurs	106		
SCOVILLE , rétracteurs pour racines nerveuses	127		
SCOVILLE-HAVERFIELD , écarteurs	120		
SCOVILLE-RICHTER , écarteurs	121		
SELVERSTONE , pinces emporte-pièces à laminectomie	155		
SEMB , pinces-gouges	78		
SMITH-PETERSON , pinces-gouges	80		
SMITHWICK , crochets à nerfs	129		
SNITMAN , écarteurs	48		
Source à lumière froide	177,178		
Spatules cérébrales	104		
Spéculums pour la chirurgie pituitaire	162		
SPINAL FUSION , curettes tranchantes	71		
SPURLING , pinces pour lames intervertébrales	154		
STANDARD , ciseaux tungstène TUC	29		
STANDARD , pinces pour poser les clips d'anéurisme	113		
STELLBRINK , pinces-gouges	74		
STILLE , perforateurs à main	62		
STILLE , pinces-gouges	78		
STILLE-RUSKIN , pinces-gouges	78		
STRULLY , ciseaux	22		
Support pour le cuir chevelu	107		
T			
TAYLOR , écarteurs	120		
TAYLOR , écarteurs spinaux	46		
TAYLOR , marteaux-percuteurs	58		
TOENNIS-ADSON-DELICATE , ciseaux tungstène TUC	33		
TÖNNIS , dissecteurs à dure-mère	132		
TROEMNER , marteaux-percuteurs	59		
U			
UNIVERSAL , ciseaux tungstène TUC	33		
UNIVERSAL , pinces-gouges	74		
V			
VANNAS , micro-ciseaux	92		

Indice alfabetico

	Pagina		Pagina
A		D	
Adattatore	176	DAHLGREEN , pinze per il cranio	99
ADSON , cannule di aspirazione	56	DAHMEN , osteotomi	68
ADSON , divaricatori	50	DAHMEN , scalpelli	68
ADSON , elevatori	73	DANDY , forbici	22
ADSON , pinze per dissezione	12	DANDY , pinze per preparazioni	10
ADSON , pinze tungsteno TUC	20	DANDY , uncini per nervi	129
ADSON , uncini per dura-madre	131	DAVIS , dissestori per dura-madre	132
ADSON-BROWN , pinze per dissezione	12	DE BAKEY , pinze atrauma	19
Agrafes al cuoio capelluto		DE BAKEY , portaghi tungsteno TUC	36
ALM , divaricatori	48	DE VILBISS , pinze per il cranio	99
ALY , strumenti per sensibilità	60	DÉJERINE , martelli percussori	59
ANDERSON-ADSON , divaricatori	49	DIETHRICH , micro-pinze	90
AUSTIN , pinze per ligatura con piattaforma	16	Dissestori per dura-madre	132-135
B		Divaricatori	44-53,114-128
BABINSKY , martelli percussori	58	Divaricatori autostatici	48-53
BABY-ADSON , pinze emostatiche	9	Divaricatori cerebrali	101-103
BABY-CRILE-WOOD , portaghi tungsteno TUC	38	Divaricatori muscolari	114,115
BABY-MIXTER , pinze per preparazioni	10	Divaricatori per ipofisi cerebrale	162
BABY-OVERHOLT , pinze emostatiche	9	Divaricatori sottili	44,45
BACON , pinze-sgorbie	76	Divaricatori spinali	46
BARRAQUER , micro-portaghi	94	Divaricatori vertebrali	116-118
BECKMANN , divaricatori	51	E	
BECKMANN-ADSON , divaricatori	52	EasyClean pinze taglienti per laminectomia	151,152
BECKMANN-EATON , divaricatori	52	ECHLIN , pinze-sgorbie	79
BELLUCCI , strumenti per la chirurgia micro	148	Elevatori	72,73
BERLINER , martelli percussori	59	F	
BEYER , pinze-sgorbie	77	FAHLBUSCH , strumenti per ipofisi cerebrale	165
BIEMER , uncini per nervi	130	FAHLBUSCH , strumenti per la chirurgia micro	148
BLUMENTHAL , pinze-sgorbie	75	FERGUSON , cannule di aspirazione	56
BÖHLER , pinze-sgorbie	77	FERRIS-SMITH , pinze taglienti per dischi intervertebrali	158
BUCK , martelli percussori	58	FERRIS-SMITH-CUSHING , pinze taglienti per laminectomia	157
C		Fili sega	98
Cannule di aspirazione	56	FISCH , uncini per nervi	130
CASPAR , divaricatori	119	Forbici	21-34,91-93
CASPAR , divaricatori vertebrali	116,118	Forbici per nervi	22
CASPAR , pinze taglienti per laminectomia	156	Forbici, micro	23-28,91-93
CASPAR , strumenti per la chirurgia micro	137,138,143	Forbici, tungsteno TUC	29-33
CASTROVIEJO , portaghi tungsteno TUC	40	FRAZIER , cannule di aspirazione	56
Cavi da connessione	170	FRAZIER , dissestori per dura-madre	133
Cavo fibra ottica	175	FRAZIER , divaricatori sottili	44
CLEVELAND , pinze-sgorbie	74	FREER , elevatori	72
Clips	105,107,109-111	FRIEDMAN , pinze-sgorbie	74
Clips per aneurismi	109-111	FRIEDMAN-MINI , pinze-sgorbie	74
CLOWARD , curette taglienti	71	FRYKHOLM , pinze-sgorbie	79
CLOWARD , pinze taglienti per laminectomia	156	G	
CLOWARD , separatori per vertebre	122,124	GEMINI , pinze per preparazioni	10
CLOWARD modif., divaricatori	122	GILLIES , divaricatori sottili	44
CONE , divaricatori	51	GOLDMAN-FOX , forbici tungsteno TUC	33
CONVERSE , portaghi tungsteno TUC	37	GRAHAM , uncini per dura-madre	131
COTTLE , martelli	69	GRONINGEN , uncini per nervi	129
COTTLE , scalpelli	162	H	
CRILE-WOOD , portaghi tungsteno TUC	38	HAJEK-KOFFLER , pinze taglienti per dischi intervertebrali	159
CRUTCHFIELD , pinze per trazione craniale	100	HALSEY , portaghi tungsteno TUC	37
Curette taglienti	71	HARDY , strumenti per ipofisi cerebrale	163,165
CUSHING , divaricatori sottili	45	HARDY-FAHLBUSCH , strumenti per ipofisi cerebrale	165
CUSHING , divaricatori spinali	46	HARMS , separatori per vertebre	125
CUSHING , pinze per dissezione	13	HARTMANN , pinze-sgorbie	75
CUSHING , pinze taglienti per dischi intervertebrali	154		
CUSHING , pinze tungsteno TUC	20		
CUSHING , uncini per dura-madre	131		
CUSHING-LANDOLT , specoli per ipofisi cerebrale	162		
CUSHING-TAYLOR , pinze tungsteno TUC	20		

HEIFETZ , pinze per afferrare tessuti	15	MEAD , pinze-sgorbie	75
HEIFETZ , spatoli cerebrali	104	METZENBAUM , forbici tungsteno TUC	29-32
HEY , divaricatori muscolari	114	METZENBAUM-DELICATE , forbici tungsteno TUC	31,32
HIBBS SPRATT , curette taglienti	71	MEYERDING , divaricatori	47
HOEN , dissestori per dura-madre	130	MICRO-ADSON , pinze per dissezione	12
HOEN , elevatori	73	Micro-forbici	23-28,91-93
HOEN , pinze emostatiche	85	MICRO-MOSQUITO , pinze emostatiche	9
HORSLEY , uncini per le radici dei nervi	127	Micro-pinze	16-18,88-90
HOSOBUCHI , strumenti per ipofisi cerebrale	167	Micro-portaghi	41,42,94
HUNT , pinze per afferrare tessuti	15	MICRO-RYDER , portaghi tungsteno TUC	37
I		MILLES , micro-forbici	92
INGE , separatori per vertebre	126	MILLIGAN , dissestori per dura-madre	134
J		MINI , pinze per applicare clips aneurismi	113
JACOBSON , micro-portaghi	42	MINI-FRIEDMAN , pinze-sgorbie	74
JACOBSON , portaghi tungsteno TUC	40	MINI-LEXER , scalpelli	66
JACOBSON , strumenti per la chirurgia micro	143	MINI-RUSKIN , pinze-sgorbie	77
JANSEN , divaricatori	48	MOLDESTAD , divaricatori sottili	45
K		N	
KERRISON , pinze taglienti per dischi intervertebrali	150,159	NAGEL , micro-forbici	91
KERRISON-COLCLOUGH , pinze per dischi intervertebrali	153	NEIVERT , portaghi tungsteno TUC	37
KILNER , divaricatori sottili	44	NICOLA , strumenti per ipofisi cerebrale	164
KLEINERT-KUTZ , divaricatori sottili	44	NICOLA , strumenti per la chirurgia micro	149
KLEINERT-KUTZ , pinze-sgorbie	77	O	
KÖLNER , clips	107	OKONEK , strumenti per la chirurgia micro	144
KOOS , strumenti per la chirurgia micro	141	OLDBERG , pinze taglienti per laminectomia	157
KRAUS , strumenti per la chirurgia micro	142	OLIVECRONA , dissestori per dura-madre	134
KRAYENBÜHL , uncini per nervi	130	OLIVECRONA , forbici	22
L		OLIVECRONA , spatoli cerebrali	104
LANDOLT , divaricatori per ipofisi cerebrale	162	OLIVECRONA-GIGLI , fili sega	98
LANDOLT , pinze taglienti per ipofisi cerebrale	161	OLIVECRONA-TOENNIS , pinze per il cuoio capelluto	106
LANDOLT , strumenti per ipofisi cerebrale	166	OMBREDANNE , martelli	69
LANDOLT-REULEN , strumenti per ipofisi cerebrale	167	Osteotomi	66-68
LANGENBECK , elevatori	72	P	
LANGENBECK , portaghi tungsteno TUC	39	PENFIELD , dissestori per dura-madre	135
LEMPERT , pinze-sgorbie	76	Perforatori a mano	62,63
LEXER , forbici tungsteno TUC	31	Pinze	11-20,89,90
LEXER , osteotomi	67	Pinze-sgorbie	74-80
LEXER , scalpelli	66,67	Pinze al cuoio capelluto	105-107
LEXER-MINI , scalpelli	66	Pinze atrauma	19
LEYLA , divaricatori cerebrali	101-103	Pinze da orologio	14
LOVE-GRUENWALD , pinze per dischi intervertebrali	154	Pinze emostatiche	9,85
LOVE , uncini per le radici dei nervi	128	Pinze emostatiche per il cuoio capelluto	8
LOVE modif., uncini per le radici dei nervi	128	Pinze per afferrare tessuti	15
LUER , pinze-sgorbie	75	Pinze per applicare clips aneurismi	112,113
M		Pinze per il cranio	99
Manico per fili sega	98	Pinze per la BI-Coagulazione	171
MARQUARDT , pinze-sgorbie	76	Pinze per ligatura con piattaforma	16,17
MARTEL , pinze per il cuoio capelluto	8	Pinze per preparazione	10,86
MARTEL , sonda per introdurre fili sega	98	Pinze per sutura	89
Martelli	58,59,69,70	Pinze per trazione craniale	100
Martelli percussori	58,59	Pinze taglienti per dischi intervertebrali	150-153,158-160
MARTIN , uncini per le radici dei nervi	128	Pinze taglienti per ipofisi cerebrale	161
MATHIEU , portaghi tungsteno TUC	39	Pinze taglienti per laminectomia	154-157
MATHIEU-DELICATE , portaghi tungsteno TUC	39	Pinze, micro	16-18,88-90
MATHIEU-RYDER-MICRO , portaghi tungsteno TUC	39	Pinze, tungsteno TUC	20
MAYFIELD , pinze-sgorbie	76	PLATTFUSS , pinze taglienti per dischi intervertebrali	160
MAYO , forbici tungsteno TUC	29	PLESTER , cannule di aspirazione	56
MAYO-HEGAR , portaghi tungsteno TUC	36	Portaghi	36-42,94-97
MAYO-HEGAR-DELICATE , portaghi tungsteno TUC	36	Portaghi, micro	41,42,94
MC KENZIE , pinze per il cuoio capelluto	106	Portaghi, tungsteno TUC	36-40
MC KENZIE , supporte per il cuoio capelluto	107	R	
		RABINER , martelli percussori	58
		RAIMONDI , pinze emostatiche	85

	Pagina		Pagina
RALK , perforatori a mano	63	W	
RANEY , clips	107	WARTENBERG , strumenti per sensibilità	60
RANEY , pinze al cuoio capelluto	107	WEITLANER , divaricatori	49
RAY , strumenti per ipofisi cerebrale	163	WILLET-MARTEL , pinze per il cuoio capelluto	8
RUSKIN , pinze-sgorbie	77,78,80	WULLSTEIN-MICRO , cannule di aspirazione	56
RUSKIN-MINI , pinze-sgorbie	77		
S		Z	
SACHS , dissestori per dura-madre	133	ZAUFAL-JANSEN , pinze-sgorbie	77
SACHS , uncini per le radici dei nervi	127		
SAMII , pinze per afferrare tessuti	15		
SAMII , strumenti per la chirurgia micro	139		
SCALP-CONTOUR , divaricatori	53		
Scalpellini	66-68		
SCHLESINGER , pinze taglienti per laminectomia	155		
SCHMIEDEN-TAYLOR , forbici	22		
SCOVILLE , divaricatori	106		
SCOVILLE , uncini per le radici dei nervi	127		
SCOVILLE-HAVERFIELD , divaricatori	120		
SCOVILLE-RICHTER , divaricatori	121		
SELVERSTONE , pinze taglienti per laminectomia	155		
SEMB , pinze-sgorbie	78		
Separatori per vertebre	124-126		
Sgorbie	66-68		
SMITH-PETERSON , pinze-sgorbie	80		
SMITHWICK , uncini per nervi	129		
SNITMAN , divaricatori	48		
Sonda per introdurre fili sega	98		
Sorgente luce fredda	177,178		
Spatoli cerebrali	104		
Specoli per ipofisi cerebrale	162		
SPINAL FUSION , curette taglienti	71		
SPURLING , pinze taglienti per dischi intervertebrali	154		
STANDARD , forbici tungsteno TUC	29		
STANDARD , pinze per applicare clips aneurismi	113		
STELLBRINK , pinze-sgorbie	74		
STILLE , perforatori a mano	62		
STILLE , pinze-sgorbie	78		
STILLE-RUSKIN , pinze-sgorbie	78		
STRULLY , forbici	22		
Strumenti per ipofisi cerebrale	161-167		
Strumenti per la chirurgia micro	87,136-145,148,149		
Strumenti per l'apertura del cranio	98,99		
Strumenti per sensibilità	60		
Supporti per il cuoio capelluto	107		
T			
TAYLOR , divaricatori	120		
TAYLOR , divaricatori spinali	46		
TAYLOR , martelli percussori	58		
TOENNIS-ADSON-DELICATE , forbici tungsteno TUC	33		
TÖNNIS , dissestori per dura-madre	132		
TROEMNER , martelli percussori	59		
U			
Uncini per dura-madre	131		
Uncini per galea	108		
Uncini per le radici dei nervi	127,128		
Uncini per nervi	129,130		
UNIVERSAL , forbici tungsteno TUC	33		
UNIVERSAL , pinze-sgorbie	74		
V			
VANNAS , micro-forbici	92		

nopa[®] instruments

nopa instruments
Medizintechnik GmbH
Weilatten 7-9
D - 78532 Tuttlingen

Tel. +49.7462.9490-0
Fax +49.7462.9490-90
info@nopa.de
www.nopa.de

Herstellung und Verkauf chirurgischer
und endoskopischer Instrumente.
Manufacture and Sales of Surgical
and Endoscopic Instruments.