



CHIRURGIE

ORL

GYNEKOLOGIE

NEUROCHIRURGIE

# NÁSTROJE PRO CHIRURGII

## INSTRUMENTS FOR SURGERY



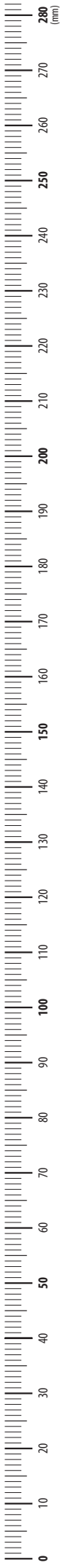





MEDIN, a.s.  
Vlachovická 619  
Nové Město na Moravě  
CZ 592 31  
Czech Republic  
IČ: 43378030  
DIČ: CZ43378030

**CENTRÁLA**  
tel.: 566 684 111

**PRODEJ ČESKÁ REPUBLIKA**  
tel.: 566 684 327  
fax: 566 684 384  
e-mail: prodej@medin.cz

**EXPORT**  
phone: +420 566 684 250  
fax: +420 566 684 385  
e-mail: export@medin.cz

**[www.medin.cz](http://www.medin.cz)**

MEDIN Slovensko, s.r.o.  
Mlynská 10  
Piešťany  
SK 921 01  
Slovak Republic  
IČ: 46540873  
SK DPH: SK2023412688

tel.: +421 337 746 259  
fax: +421 337 746 153  
e-mail: jana.snajdarova@medin.sk

**[www.medin.sk](http://www.medin.sk)**

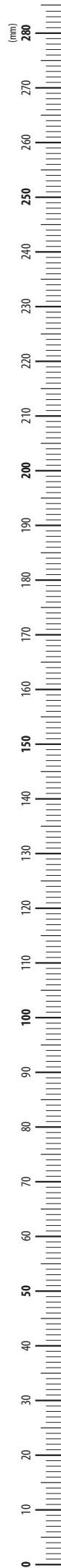

POZNÁMKA:

Katalogová čísla MEDIN jsou v katalogu uvedena ve zkrácené podobě bez předčísí pro zdravotnické prostředky.

Například: katalogové číslo / objednáací číslo  
XXX XX XXXX / 397XXXXXXXXX

Aktuální konverzní tabulku nebo ceník s kompletními objednáacími čísly si vyžádejte u svého obchodního zástupce.

NOTE:

MEDIN catalogue numbers in this catalogue are listed in short form without the prefix for medical devices.

For example: catalogue number / order number  
XXX XX XXXX / 397XXXXXXXXX

Ask your sales representative for the up-to-date conversion table or the price list with complete ordering numbers.

© 2018 MEDIN, a.s.; Všechna práva vyhrazena.

Dokument je určen pro obchodní účely MEDIN, a.s., údaje zde uvedené jsou informativního charakteru.

Žádná část tohoto dokumentu nesmí být reprodukována nebo publikována v jakékoliv formě bez předchozího souhlasu MEDIN, a.s. Zobrazení produktů odpovídá aktuálnímu stavu v době vydání tohoto dokumentu. Změny technických parametrů z důvodu dalšího vývoje jsou vyhrazeny.

Tiskové a typografické chyby jsou vyhrazeny.

© 2018 MEDIN, a.s.; All rights reserved.

This document should be used for commercial purposes of MEDIN, a.s.; the data mentioned in the document has informative character. No part of this document can be copied or published in any form without approval of MEDIN, a.s.

The product design may differ from those depicted in these illustrations at the date of issue. Adjustments, made from the reason of further developments of technical parameters, are reserved.

Printing and typographical errors are reserved.

# Od zubních vrtáčků po špičkové traumatologické implantáty MEDIN

MEDIN, a.s., je tradičním českým výrobcem lékařských nástrojů a implantátů. Portfolio firmy tvoří produkty pro traumatologii, chirurgii, stomatologii a ortopedii. Společnost dodává své výrobky do desítek zemí celého světa.

## Zahájení výroby a budování podniku Chirana

Budoucnost jedné z předních společností České republiky se začala psát dne 29. srpna 1948, kdy byl v Novém Městě na Moravě položen **základní kámen závodu Chirana**. V roce 1949 byla zahájena výroba zubních vrtáčků a fréz pro zubní laboratoře.



V únoru 1950 rozšířila Chirana své **portfolio o chirurgii**. Do výrobního programu bylo zařazeno 25 druhů nejběžnějších chirurgických nástrojů. Ve stejném roce Chirana **poprvé exportuje** své výrobky, a sice do Bulharska, Rumunska a Německa.



Roku 1957 byl podnik rozšířen začleněním firmy Diamantrob, která se zabývala patentově chráněnou výrobou diamantových nástrojů pro zubní lékaře. Chirana pod své vedení vzala také



firmu Pelc-Tyrolka a firmu Koutný, produkující speciální nástroje pro chirurgii. **V roce 1968 byl zřízen holding Chirana Nové Město.**



Počátkem 70. let dominovala snaha o rozšíření výroby. Výsledkem bylo více než 5 milionů vyrobených vrtáčků, počátkem 80. let až 9 milionů vrtáčků. Výroba pokrývala také přes 4 tisíce druhů chirurgických nástrojů.

Do výrobního programu byl v roce 1990 zařazen **obor traumatologie**.



## Privatizace a vznik společnosti MEDIN

V roce 1992 byl státní podnik Chirana zařazen do první vlny privatizace a dne 24. března 1992 vznikla akciová společnost MEDIN, právní nástupce státního závodu Chirana. V té době byla firma MEDIN vlastněná 154 zaměstnanci podniku.



Dne 23. března 2006 koupila společnost MEDIN firmu WALTER Medica a následně ji přejmenovala na MEDIN Orthopaedics, a.s. Společnost MEDIN tím rozšířila své **portfolio o ortopedii**.

V roce 2010 byla založena v Rusku dceřiná společnost MEDIN RU. Společnost MEDIN se od roku 2011 prezentuje novým logem.



MEDIN získal v roce 2012 druhou dceřinou společnost, a sice založením firmy MEDIN Slovensko. V roce 2013 došlo k propojení obchodní sítě MEDIN s firmou ProSpon, spol. s r.o. a MEDIN se tak stal výhradním distributorem ortopedických výrobků společnosti ProSpon. Dne 14. března 2014 zvítězil MEDIN, a.s., v soutěži Česká inovace v kategorii Inovativní firma. Ocenění se váže k patentovanému patnímu hřebu C-NAIL.

## Školení lékařů

Vedle vlastní kvalitní výzkumné a vývojové základny je nezbytným předpokladem inovativnosti firmy a uplatnění svých produktů v náročných podmínkách trhu schopnost poskytovat kvalitní doprovodné služby. Jednou z těchto služeb, kterým se společnost MEDIN úspěšně věnuje, je pořádání odborných školení, praktických workshopů a seminářů zejména pro mladé lékaře a další zdravotnický personál. Tato vzdělávání probíhají v úzké spolupráci s firmou SOGGIORNO, s.r.o., v rámci celoživotního vzdělávání zdravotníků formou výuky operačních postupů s novými nebo inovovanými produkty firmy. Odborné semináře vedou špičkoví a vysoce uznávaní lékaři zejména v oborech traumatologie, ortopedie a chirurgie, s nimiž se firmě podařilo navázat úspěšnou dlouhodobou spolupráci. Školení je zajišťováno ve školicím středisku přímo v areálu společnosti MEDIN nebo v prostředí klienta.



# Jaké hodnoty vám předáváme společně s výrobky?



Každý nástroj či implantát projde během zpracování rukama řady lidí a jeho výroba trvá až několik hodin. Nese tak s sebou i kus naší filozofie a základních hodnot.

*Kompletní nákup chirurgických nástrojů.  
Ze široké nabídky firmy MEDIN jsme si  
dokázali velmi dobře vybrat.“*

*Mgr. Renáta Michalíčková, staniční sestra  
op. sálů, Thomayerova nemocnice Praha*

## Užitná hodnota výrobku

Celá cesta výrobku, od vlastního vývoje po distribuci, má jediný cíl. Dát lékařům do rukou kvalitní nástroj, který usnadní operační zákrok a pomůže při jejich vlastní práci.

*„MEDIN instruments are good quality and long life. Most of the items prices are reasonable. We have been dealing with MEDIN for 6 years.“*

*A. A. Zahar, Sala Medical, Oman*

## Zákazník

Našimi konečnými zákazníky jsou lékaři a zdravotní sestry z oborů chirurgie, traumatologie, ortopedie a stomatologie. Snažíme se, aby řešení, která zákazníkům přinášíme, co nejvíce kopírovala jejich potřeby.



Testování nového instrumentária

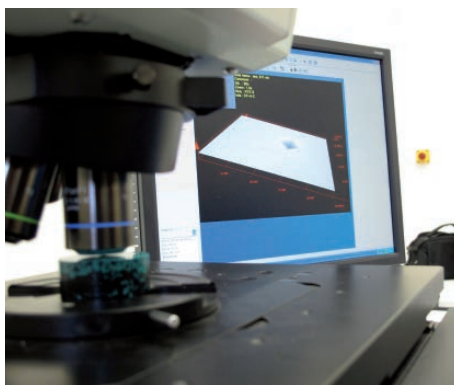

Zkoušky tvrdosti výrobku

*„Komunikace je na velké úrovni a skoro vše vyřídí jeden telefonát a to s velkou ochotou.“*

*Markéta Adamová, staniční sestra ORT  
op. sály, Nemocnice Rudolfa a Stefanie Benešov*

## Naše okolí

Uvědomujeme si, že každá lidská činnost přináší změny v životním prostředí. Proto aplikujeme systém environmentálního managementu EMS. V rámci modelu Plan – Do – Check – Act Cycle neustále zkoumáme jednotlivé postupy ve firmě a hledáme ekologicky šetrnější varianty.



Sídlo naší společnosti se nachází v Novém Městě na Moravě, v dějišti řady sportovních událostí

## Certifikáty

Společnost MEDIN je držitelem těchto certifikátů:

Certifikát ISO 13485

Certifikát ISO 14001

CE značka

Certifikáty jsou k dispozici ke stažení na webových stránkách: [www.medin.cz/certifikaty](http://www.medin.cz/certifikaty).





# From tooth drills to top-class traumatology implants MEDIN

MEDIN, a.s., is a traditional Czech producer of medical instruments and implants. The company's portfolio consists of products for traumatology, surgery, dentistry and orthopaedics. The company exports its products to dozens of countries around the world.

## The start of production and building Chirana

The future of one of the leading companies in the Czech Republic began on 29 August 1948, when the **foundation stone of the** Chirana works was laid in Nové Město na Moravě. In 1949, production started on dental drills and milling cutters for dental laboratories.



In February 1950 Chirana expanded its **portfolio to surgery**. 25 of the most common surgical instruments were included in the production programme. In the same year Chirana **first exported** its products, namely to Bulgaria, Romania and Germany.



In 1957 the company expanded by incorporating Diamantrob, which was involved in the patented production of diamond tools for dentists. Chirana



also took Pelc-Tyrolka and Koutný, companies producing special tools for surgery, under its management. **The Chirana Nové Město holding was set up in 1968.**



The early 1970s were dominated by an endeavour to expand production. The result was the manufacture of over 5 million drills, in the early 80's this had increased to 9,000,000 drills. Production covered over 4,000 kinds of surgical instruments. The field of traumatology was introduced into the production programme in 1990.



## Privatization and the emergence of MEDIN

In 1992, the state enterprise Chirana was included in the first wave of privatization and on 24 March 1992 the joint-stock company MEDIN was founded, the legal successor to the state-owned Chirana. At the time, MEDIN was owned by 154 company employees.



On 23 March 2006, MEDIN bought WALTER Medica and subsequently changed its name to MEDIN Orthopaedics, a.s. This allowed MEDIN to expand its **portfolio to orthopaedics.**

In 2010 a subsidiary, MEDIN RU, was founded in Russia. Since 2011 MEDIN has had a new logo.



In 2012 MEDIN gained a second subsidiary, namely through the founding of MEDIN Slovensko. In 2013 the MEDIN business network was linked to ProSpon, spol. s r.o. and MEDIN became the exclusive distributor of orthopaedic products for ProSpon. On 14 March 2014 MEDIN, a.s., won the Czech Innovation contest in the Innovative Company category. The award is for C-NAIL a patented calcaneal nail.

## Training doctors

Besides its high-quality research and development programme, the provision of good-quality services is a prerequisite of a company's innovation and its ability to sell its products in the demanding conditions of today's market. One of these services, which MEDIN has had great success in, is the organization of professional training, practical workshops and seminars especially for young physicians and other medical personnel. This training takes place in close cooperation with SOGGIORNO, s.r.o., as part of lifelong education for health care professionals and takes the form of training in operating procedures with new or innovated products from the company. Professional seminars are led by leading and highly respected doctors, in particular in the fields of orthopaedics, traumatology and surgery, with whom the company has been able to establish successful, long-term cooperation. Training is provided in the training centre directly at MEDIN or at the client's premises.



# What is the added value we offer with our products?



During processing, each instrument or implant passes through the hands of a number of people and takes up to several hours to produce. As such it carries a part of our philosophy and basic principles with it.

*"Our operating theatres are brand new which meant purchasing a full range of surgical instruments. We were spoilt for choice from the wide offer range provided by MEDIN."*

*MSc Renáta Michalíčková, Head Nurse for operating theatre at Thomayer's Hospital, Prague.*

## Customer

Our end customers are doctors and nurses from the fields of surgery, traumatology, orthopaedics and stomatology. We try to ensure that the solutions we deliver to customers match their needs as closely as possible.



Testing of new instrumentaria

## Useful product value

Throughout the journey of making a product, from actual development right up until distribution, there is only one goal – to provide doctors with a quality instrument which will facilitate the operation procedure and assist them in their own work.

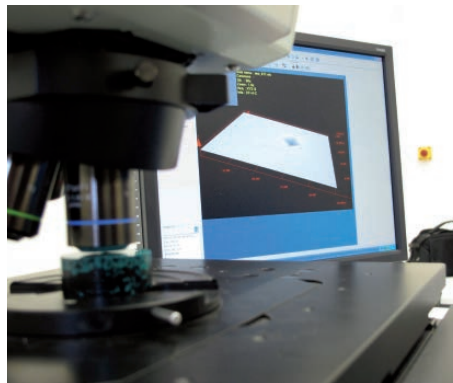

Tests on product hardness

*"Communication is of the highest level and is almost always dealt with over one phone call and with a great sense of willingness"*

*Markéta Adamová, Head Nurse ORT operating theatre, Rudolf and Stephanie Hospital, Benešov*

*"MEDIN instruments are good quality and long lasting. Most prices of items are reasonable. We have been dealing with Medin for 6 years."*

*A. A. Zahar, Sala Medical, Oman*

## Our surroundings

We are aware that all human activity is accompanied by changes in our environment. For this reason we have put in place a system of environmental management called EMS. As part of our Plan – Do – Check – Act Cycle model, we are constantly exploring individual processes in the company and looking for options which demonstrate greater consideration to the environment.



Our head offices are located in Nové Město na Moravě, venue of sporting events

## Certificates

The company MEDIN has been a holder of these certificates:

Certificate ISO 13485

Certificate ISO 14001

EC Certificate

Certificates are available to download on this website: [www.medin.cz/certificates](http://www.medin.cz/certificates).



**NÁSTROJE PRO CHIRURGII**  
INSTRUMENTS FOR SURGERY

**NÁSTROJE PRO ORL**  
INSTRUMENTS FOR ENT

**NÁSTROJE PRO GYNEKOLOGII**  
INSTRUMENTS FOR GYNAECOLOGY

**NÁSTROJE PRO NEUROCHIRURGII**  
INSTRUMENTS FOR NEUROSURGERY

**NÁSTROJE PRO CHIRURGII**  
INSTRUMENTS FOR SURGERY

**NÁSTROJE PRO ORL**  
INSTRUMENTS FOR ENT

**NÁSTROJE PRO GYNEKOLOGII**  
INSTRUMENTS FOR GYNAECOLOGY

**NÁSTROJE PRO NEUROCHIRURGII**  
INSTRUMENTS FOR NEUROSURGERY



	<b>NÁSTROJE PRO CHIRURGII</b>	<b>INSTRUMENTS FOR SURGERY</b>	9–355
397 111	Diagnostika	Diagnostic	11–16
397 112	Nástroje řezné	Cutting Instruments	17–28
397 113	Nůžky	Scissors	29–70
397 114	Pinzety	Forceps	71–93
397 115	Svorky	Clamps, Forceps	95–170
397 116	Kleště štípací	Bone Rongeurs	171–186
397 117	Kleště úchopné	Grasping Forceps	187–204
397 118	Háky	Hooks, Retractors	205–228
397 119	Rozvěrače	Retractors	229–250
397 121	Lopatky	Spatulas	251–254
397 122	Zrcadla	Specula	255–258
397 123	Páčidla	Elevators	259–266
397 124	Škrabky	Raspatories	267–272
397 125	Lžičky	Spoons	273–280
397 127	Pilky, pilníky	Saws, Files	281–286
397 128	Dláta, kladiva	Chisels, Mallets	287–292
397 132	Jehly, jehelce	Needles, Needle Holders	293–318
397 133	Pátradla	Probes	319–325
397 134	Trokary, odsávačky	Trocars, Suction Tubes	327–336
397 135	Dilatátory	Dilators	337–343
397 136	Speciální nástroje	Special Instruments	345–355
	<b>NÁSTROJE PRO ORL</b>	<b>INSTRUMENTS FOR ENT</b>	357–435
	<b>NÁSTROJE PRO GYNEKOLOGII</b>	<b>INSTRUMENTS FOR GYNAECOLOGY</b>	437–496
	<b>NÁSTROJE PRO NEUROCHIRURGII</b>	<b>INSTRUMENTS FOR NEUROSURGERY</b>	497–561
	Číselný rejstřík	Numerical Index	563–616
	Jmenný rejstřík	Alphabetical Index	617–633
	Symboly	Symbols	634



# 111

## DIAGNOSTIKA DIAGNOSTIC

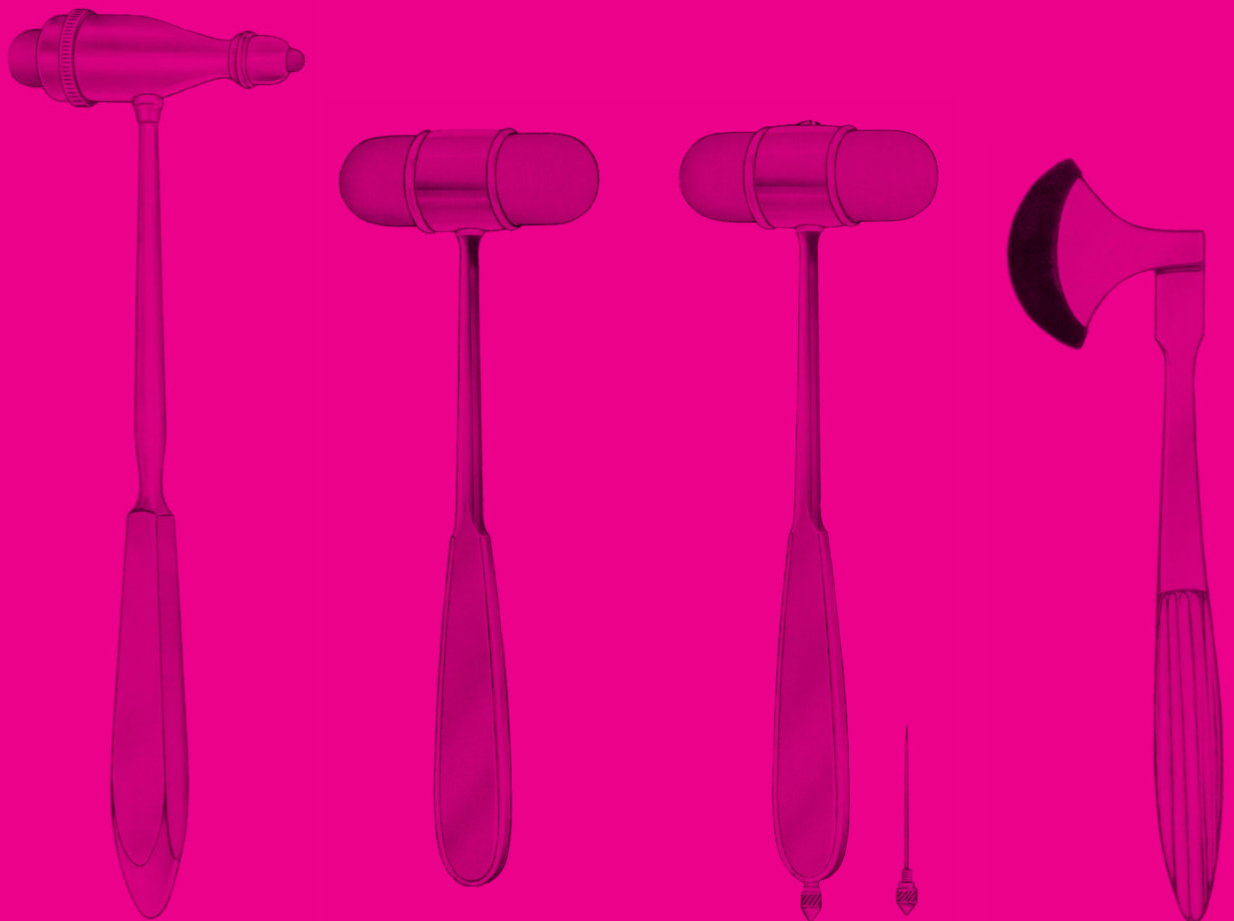







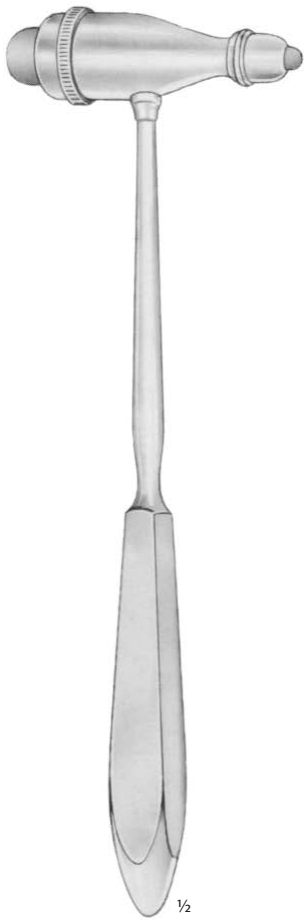

**TROEMNER**  
**111 91 0077**  
24,0 cm

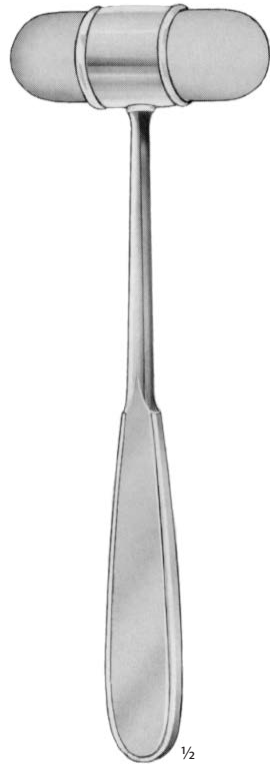

**DÉJERINE**  
**111 91 0078**  
20,0 cm



**DÉJERINE**  
**111 91 0079**  
20,0 cm

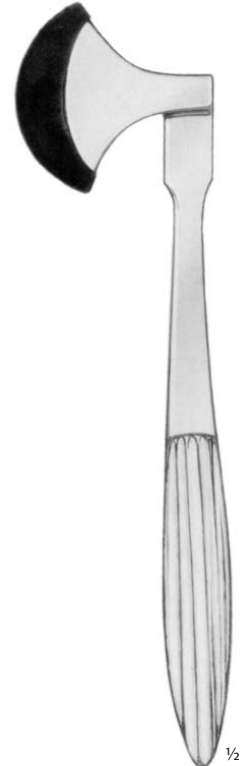

**BERLINER**  
**111 91 0080**  
20,0 cm



**456-602-500**  
ø 5,0 cm × 5,0 cm  
0,05 l



- 111 91 0081** 15,0 cm
- 111 91 0082** 20,0 cm
- 111 91 0083** 30,0 cm
- 111 91 0084** 50,0 cm



- 111 91 0085**  
150,0 cm

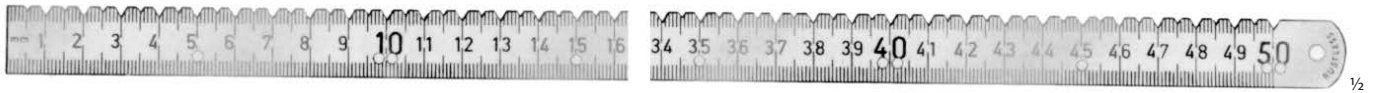

- 111 91 0086**  
50,0 cm  
pro RTG záření  
X-ray

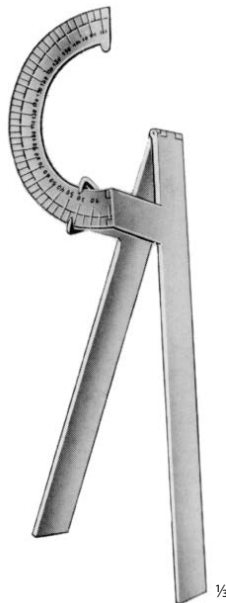

**MOELTGEN**  
**111 91 0088**

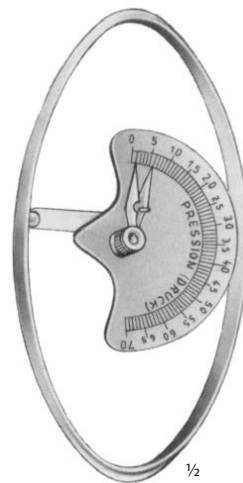

**COLLIN**  
**111 91 0090** pro dospělé  
adults      **111 91 0091** dětský  
children



# 112

## NÁSTROJE ŘEZNÉ CUTTING INSTRUMENTS







**112 91 0002**  
12,3 cm  
Fig. 3



**112 91 0003**  
12,3 cm  
Fig. 3



**112 91 0004**  
13,3 cm  
Fig. 4

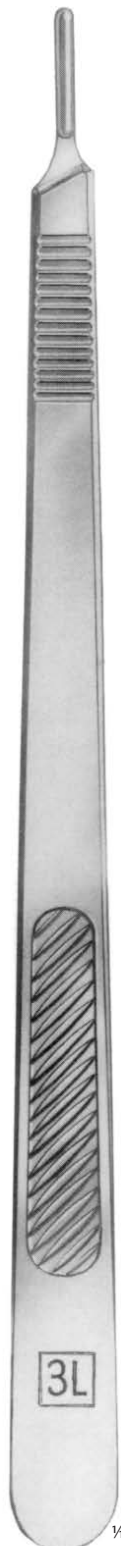

**112 91 0005**  
20,5 cm  
Fig. 3L



**112 91 0006**  
20,5 cm  
Fig. 4L



**112 91 0007**  
16,5 cm  
Fig. 7



**COLLIN**  
**112 91 0008**  
13,3 cm  
duté  
hollow  
Fig. 8

## SKALPELOVÉ ČEPELKY STERILNÍ PRO VELIKOST DRŽÁTKA 3

SCALPEL BLADES STERILE FOR HANDLE SIZE 3

pro držátka  
for handles112 91 0002  
112 91 0003  
112 91 0005  
112 91 0007**112 91 0010**  
Fig. 10**112 91 0011**  
Fig. 11**112 91 0012**  
Fig. 12**112 91 0025**  
Fig. 12d**112 91 0013**  
Fig. 13**112 91 0015**  
Fig. 15**112 91 0026**  
Fig. 15cPOZNÁMKY: sterilní, balení 100 ks  
NOTES: sterile, packing 100 pcs

## SKALPELOVÉ ČEPELKY STERILNÍ PRO VELIKOST DRŽÁTKA 4

SCALPEL BLADES STERILE FOR HANDLE SIZE 4

pro držátka  
for handles112 91 0004  
112 91 0006  
112 91 0008**112 91 0018**  
Fig. 18**112 91 0020**  
Fig. 20**112 91 0021**  
Fig. 21**112 91 0022**  
Fig. 22**112 91 0023**  
Fig. 23**112 91 0024**  
Fig. 24**112 91 0027**  
Fig. 25POZNÁMKY: sterilní, balení 100 ks  
NOTES: sterile, packing 100 pcs

## JEHLY EPILAČNÍ

DEPILATION NEEDLES

kuželová  
conical**112 08 2090** Ø 0,09 mm 3,1 cm**112 08 2080** Ø 0,10 mm 3,1 cm**112 08 2100** Ø 0,12 mm 3,1 cmPOZNÁMKY: sterilní, balení 10 ks  
NOTES: sterile, packing 10 pcs

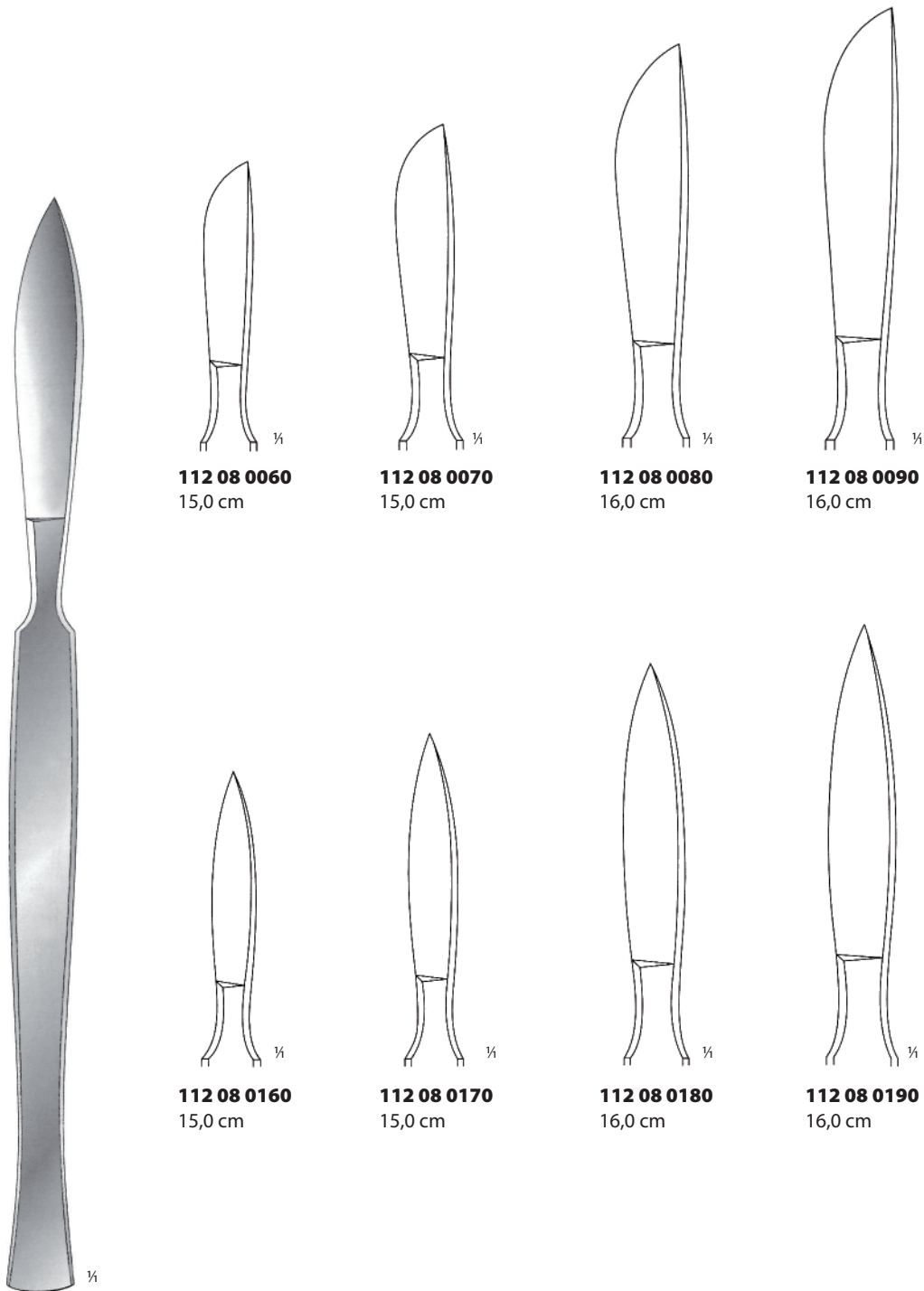

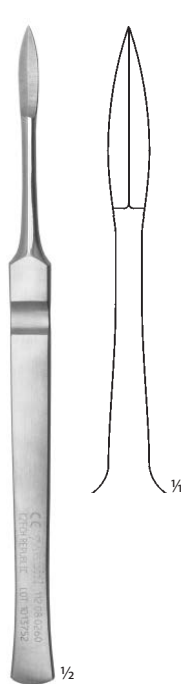

**112 08 0260**  
17,0 cm

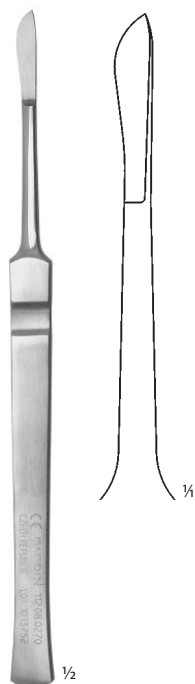

**112 08 0270**  
17,5 cm

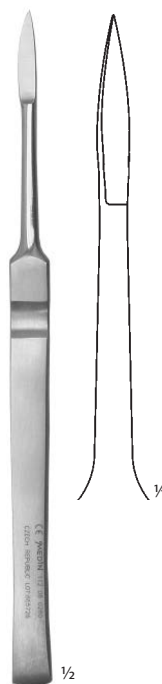

**112 08 0280**  
17,5 cm

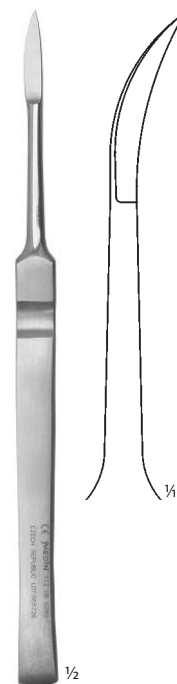

**112 08 0290**  
17,5 cm

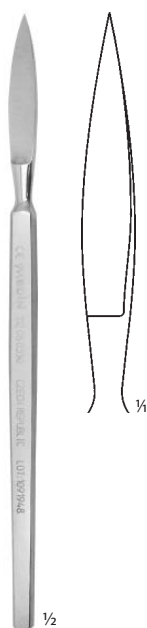

Skalpel s hranatým držadlem  
Operating knife square handle  
**112 08 0350**  
16,0 cm



Nůž resekcí  
Resection knife  
**112 08 0710**  
17,0 cm





**DIEFFENBACH**  
12,5 cm



**112 38 0010**  
Fig. 1  
12,5 cm



**112 38 0020**  
Fig. 2  
13,0 cm



**112 38 0030**  
Fig. 4  
13,5 cm



**112 38 0040**  
Fig. 5  
14,0 cm



**112 38 0110**  
Fig. 7  
12,5 cm



**112 38 0120**  
Fig. 8  
13,0 cm



**112 38 0130**  
Fig. 9  
13,5 cm



**112 38 0140**  
Fig. 10  
14,0 cm



Nástroj dvojitý na cizí těleso v rohovce  
Double foreign body instrument  
**112 38 2200**  
10,0 cm

NOŽE NA VARIXY  
KNIVES FOR VARICES

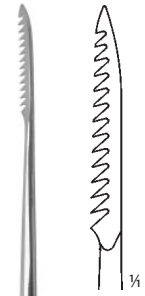

1/2

**112 14 0400**  
22,0 cm

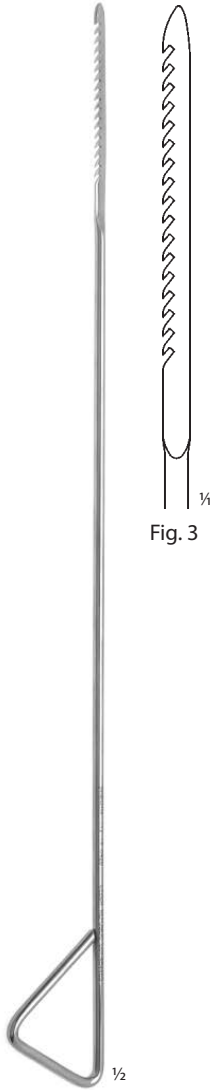

1/2

**112 14 0420**  
28,5 cm

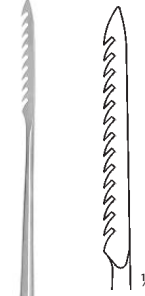

1/2

**112 14 0510**

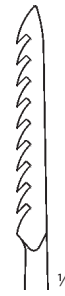

1/4

**112 14 0520**



1/4

**112 14 0550**

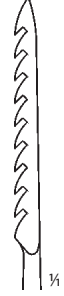

1/4

**112 14 0570**

**112 14 0520**  
22,0 cm



1/4

4,0 mm



1/2

Nůž klapův  
Klapp knife  
**112 99 0014**  
22,0 cm



1/2

**COLLIN**  
**112 91 0062**  
26,0 cm  
délka čepel 13,0 cm  
length of blade 13,0 cm

**112 08 0740**  
29,0 cm  
délka čepel 16,0 cm  
length of blade 16,0 cm

**112 08 0770**  
35,0 cm  
délka čepel 22,0 cm  
length of blade 22,0 cm



1/2

**CATLIN**  
**112 91 0067**  
29,0 cm  
délka čepel 16,0 cm  
length of blade 16,0 cm

**112 91 0069**  
35,0 cm  
délka čepel 22,0 cm  
length of blade 22,0 cm



1/2

**LANGENBECK**  
**112 08 0730**  
24,0 cm  
délka čepel 12,0 cm  
length of blade 12,0 cm



1/2

**REINER**  
**112 05 0010**  
18,5 cm



1/2

**VIRCHOW  
112 01 0210**

délka čepel 16,0 cm  
length of blade 16.0 cm  
29,0 cm



1/2

**VIRCHOW  
02-990-080**

s dřevěným držadlem  
délka čepel 8,0 cm  
wooden handle  
length of blade 8.0 cm  
21,0 cm



1/2

Nůž pitevní  
Post mortem knife  
**112 01 0240**  
24,0 cm



1/2

Nůž pitevní  
Post mortem knife  
**112 01 0250**  
25,5 cm

JEHLY PREPARAČNÍ  
DISSECTING NEEDLES



**112 02 0100**  
13,5 cm  
Fig. 1



**112 02 0110**  
13,5 cm  
Fig. 2



**112 02 0300**  
13,5 cm



Klička na výtěry  
Wire loop for microscopy  
**112 02 0410**  
7,0 cm  
Ø 3,1 mm  
balení 10 ks  
packing 10 pcs

NOŽE NA MENISKUS  
MENISCUS KNIVES



**112 09 0010**  
Fig. 1

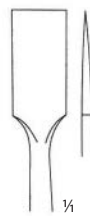

**112 09 0020**  
Fig. 2

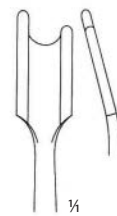

**112 09 0030**  
Fig. 3



**REHN**  
**112 91 0087**  
25,0 cm

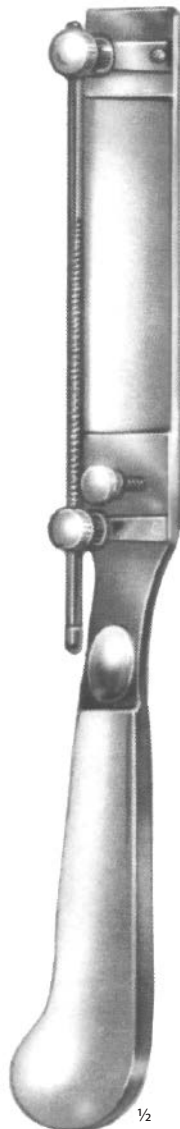

**SCHINK**  
**112 91 0088**  
30 cm



Čepel k transplantačnímu  
noži Schink  
Blade for transplantation  
knife Schink  
**112 91 0089**



**HUMBY**  
**112 12 0120**  
31,0 cm



Čepel pro nůž  
transplantační  
Blade for  
transplantation knife  
**112 12 0130**  
15,5 cm



# 113

## NŮŽKY SCISSORS





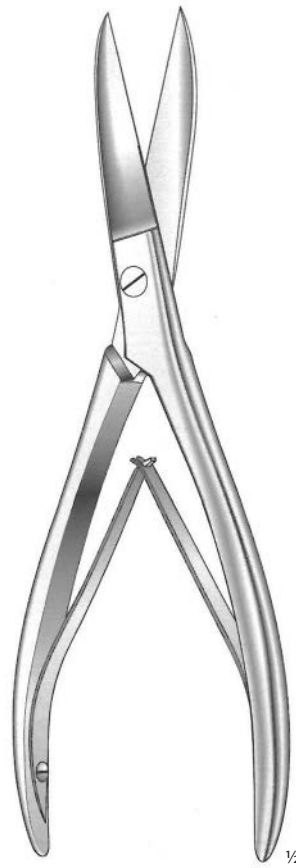

**113 01 0210**  
rovné  
straight  
23,0 cm

NŮŽKY CHIRURGICKÉ  
SURGICAL SCISSORS



Nůžky chirurgické na incisi  
Incision scissors  
**113 91 0071** 13,0 cm  
**113 08 0810** 14,0 cm

**RICHTER**  
**113 05 0020**  
14,5 cm

NŮŽKY CHIRURGICKÉ  
OPERATING SCISSORS

Original 15 cm

STANDARD  
hrotnaté rovné  
sharp straight

**113 08 0010** 13,0 cm  
**113 08 0020** 15,0 cm  
**113 08 0040** 18,5 cm  
**113 08 0060** 22,0 cm  
**113 08 0070** 30,0 cm

½



Original 15 cm

STANDARD  
hrotnaté zahnuté  
sharp curved

**113 08 0310** 13,0 cm  
**113 08 0320** 15,0 cm  
**113 08 0340** 18,5 cm  
**113 08 0360** 22,0 cm  
**113 08 0370** 30,0 cm

½



Original 15 cm

STANDARD  
hrotnatotupé rovné  
sharp-blunt straight

**113 08 0110** 13,0 cm  
**113 08 0120** 15,0 cm  
**113 08 0140** 18,5 cm  
**113 08 0160** 22,0 cm

½



Original 15 cm

STANDARD  
hrotnatotupé zahnuté  
sharp-blunt curved

**113 08 0410** 13,0 cm  
**113 08 0420** 15,0 cm  
**113 08 0440** 18,5 cm  
**113 08 0460** 22,0 cm

½



Original 15 cm

STANDARD  
tupé rovné  
blunt straight

**113 08 0210** 13,0 cm  
**113 08 0220** 15,0 cm  
**113 08 0240** 18,5 cm  
**113 08 0260** 22,0 cm

½



Original 15 cm

STANDARD  
tupé zahnuté  
blunt curved

**113 08 0510** 13,0 cm  
**113 08 0520** 15,0 cm  
**113 08 0540** 18,5 cm  
**113 08 0560** 22,0 cm

½

POZNÁMKY: 113 08 XXXX – leštěné; 113 91 XXXX – matované  
 NOTES: 113 08 XXXX – glossy; 113 91 XXXX – matt

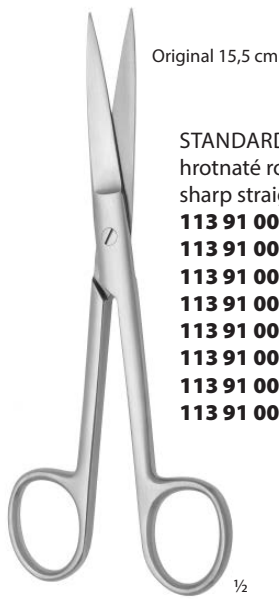

Original 15,5 cm

STANDARD  
hrotnaté rovné  
sharp straight

<b>113 91 0041</b>	10,5 cm
<b>113 91 0042</b>	11,5 cm
<b>113 91 0043</b>	13,0 cm
<b>113 91 0044</b>	14,5 cm
<b>113 91 0045</b>	15,5 cm
<b>113 91 0046</b>	16,5 cm
<b>113 91 0047</b>	18,5 cm
<b>113 91 0049</b>	20,0 cm

½

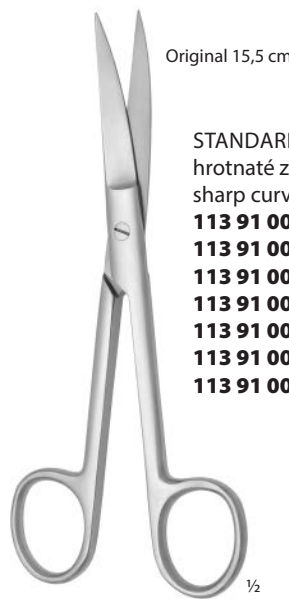

Original 15,5 cm

STANDARD  
hrotnaté zahnuté  
sharp curved

<b>113 91 0051</b>	11,5 cm
<b>113 91 0052</b>	13,0 cm
<b>113 91 0053</b>	14,5 cm
<b>113 91 0054</b>	15,5 cm
<b>113 91 0055</b>	16,5 cm
<b>113 91 0057</b>	18,5 cm
<b>113 91 0058</b>	20,0 cm

½

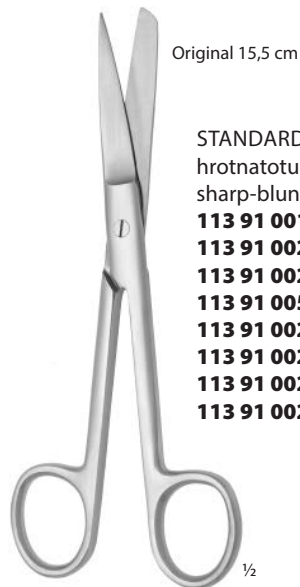

Original 15,5 cm

STANDARD  
hrotnatotupé rovné  
sharp-blunt straight

<b>113 91 0019</b>	10,5 cm
<b>113 91 0020</b>	11,5 cm
<b>113 91 0021</b>	13,0 cm
<b>113 91 0059</b>	14,5 cm
<b>113 91 0023</b>	15,5 cm
<b>113 91 0026</b>	16,5 cm
<b>113 91 0027</b>	18,5 cm
<b>113 91 0029</b>	20,0 cm

½

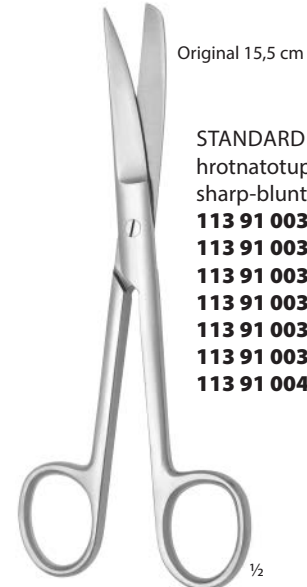

Original 15,5 cm

STANDARD  
hrotnatotupé zahnuté  
sharp-blunt curved

<b>113 91 0031</b>	11,5 cm
<b>113 91 0032</b>	13,0 cm
<b>113 91 0033</b>	14,5 cm
<b>113 91 0034</b>	15,5 cm
<b>113 91 0037</b>	16,5 cm
<b>113 91 0039</b>	18,5 cm
<b>113 91 0040</b>	20,0 cm

½

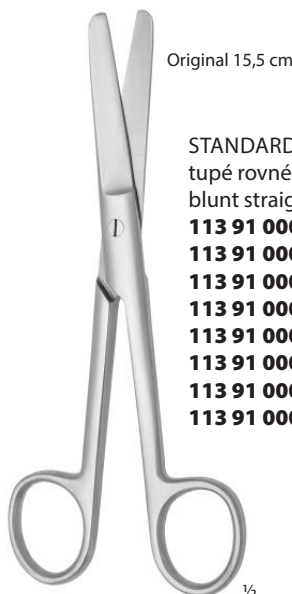

Original 15,5 cm

STANDARD  
tupé rovné  
blunt straight

<b>113 91 0001</b>	10,5 cm
<b>113 91 0002</b>	11,5 cm
<b>113 91 0003</b>	13,0 cm
<b>113 91 0004</b>	14,5 cm
<b>113 91 0005</b>	15,5 cm
<b>113 91 0006</b>	16,5 cm
<b>113 91 0008</b>	18,5 cm
<b>113 91 0009</b>	20,0 cm

½

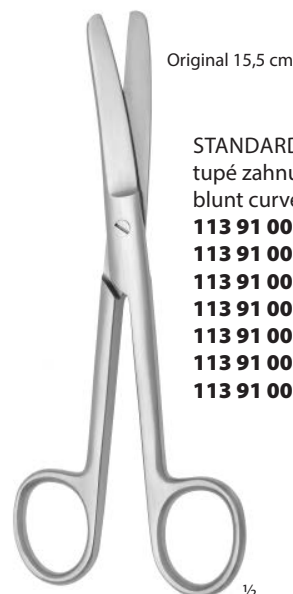

Original 15,5 cm

STANDARD  
tupé zahnuté  
blunt curved

<b>113 91 0011</b>	11,5 cm
<b>113 91 0012</b>	13,0 cm
<b>113 91 0013</b>	14,5 cm
<b>113 91 0014</b>	15,5 cm
<b>113 91 0015</b>	16,5 cm
<b>113 91 0017</b>	18,5 cm
<b>113 91 0018</b>	20,0 cm

½



**DEAVER**  
**113 91 0077**  
14,0 cm

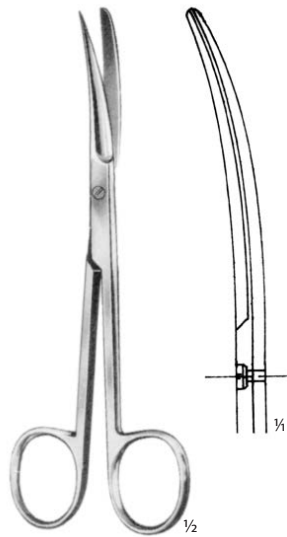

**DEAVER**  
**113 91 0078**  
14,0 cm

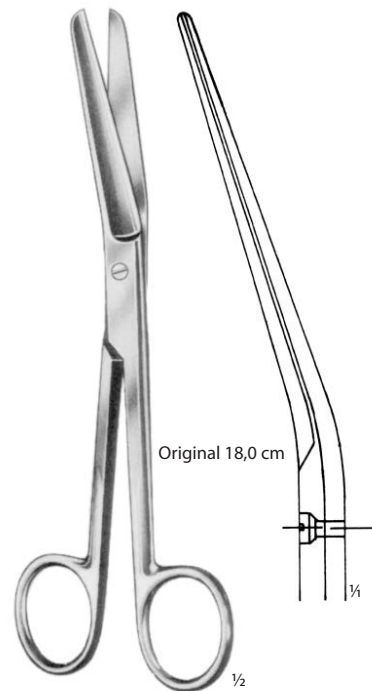

**FERGUSSON**  
**113 91 0075** 16,5 cm  
**113 91 0076** 18,0 cm

## NŮŽKY CHIRURGICKÉ JEMNÉ FINE OPERATING SCISSORS

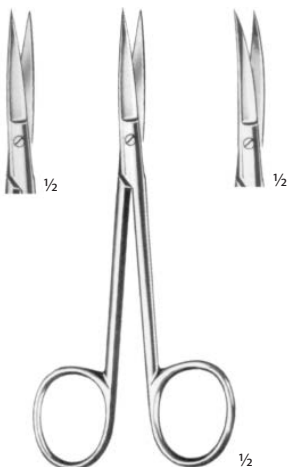

**WAGNER**  
**113 91 0328**  
jemné rovné  
fine straight  
12,0 cm

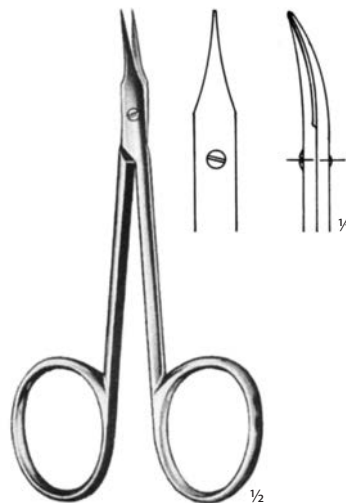

**WAGNER**  
**113 91 0331**  
jemné zahnuté  
fine curved  
12,0 cm

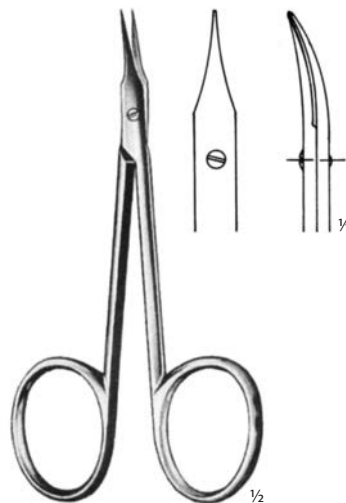

**WALTON**  
**113 91 0348**  
10,0 cm

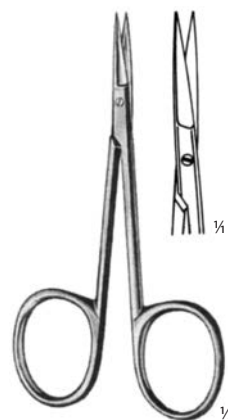

**MOD. BONN**  
**113 91 0349**  
extra jemné  
extra delicate  
8,0 cm

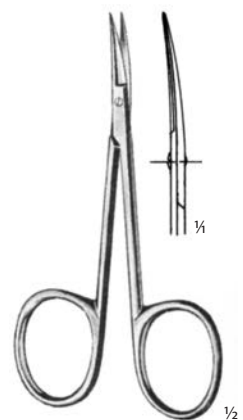

**MOD. BONN**  
**113 91 0350**  
extra jemné  
extra delicate  
8,0 cm



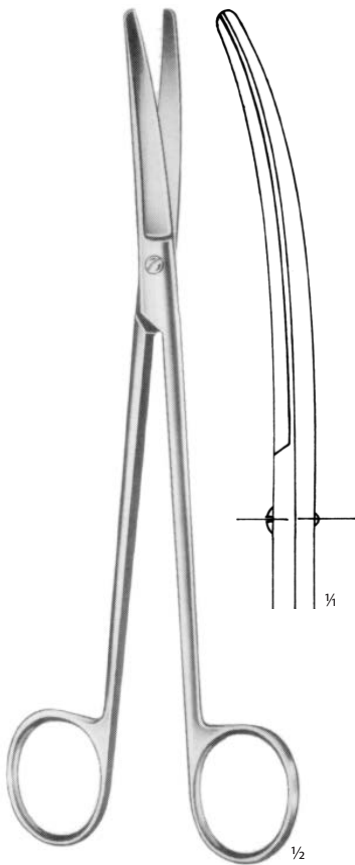

**WERTHEIM**  
**113 91 0116**  
22,5 cm

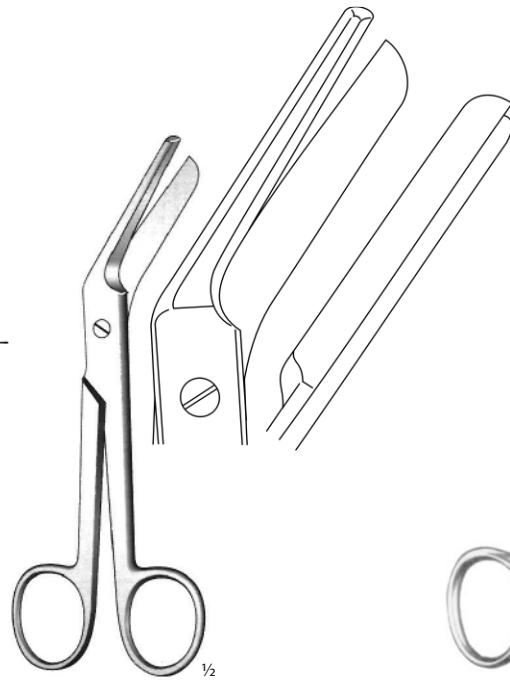

**BRAUN-STADLER**  
**113 91 0317**  
14,0 cm

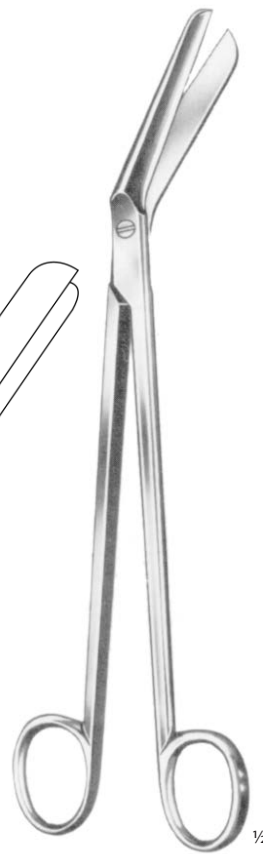

**BRAUN-STADLER**  
**113 91 0318**  
22,0 cm

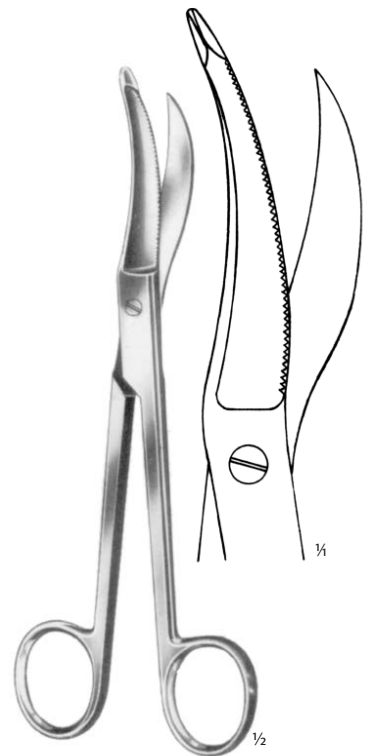

**WALDMANN**  
**113 91 0319**  
18,0 cm



**KELLY**  
**113 91 0110**  
rovné  
straight  
16,0 cm

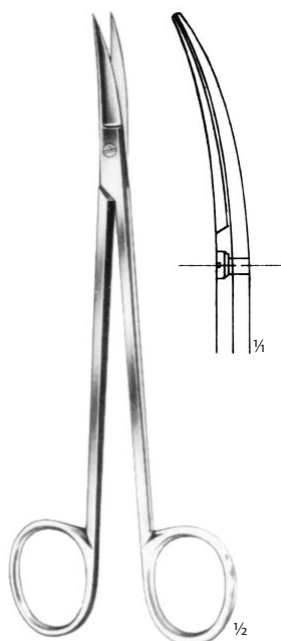

**KELLY**  
**113 91 0112**  
zahnuté  
curved  
16,0 cm



**DOYEN**  
**113 91 0106**  
rovné  
straight  
16,0 cm

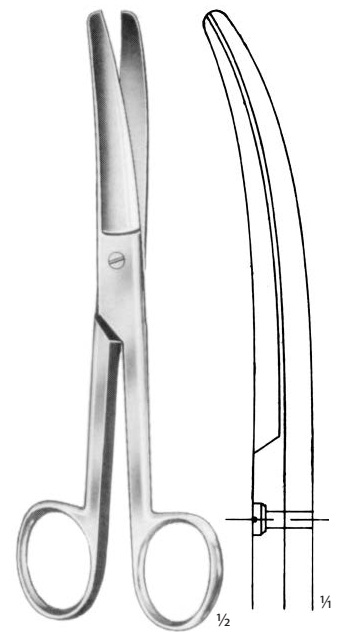

**DOYEN**  
**113 91 0107**  
zahnuté  
curved  
16,0 cm



**SIMS**  
**113 91 0121** 20,0 cm **113 91 0125**  
**113 91 0122** 23,0 cm **113 91 0126**

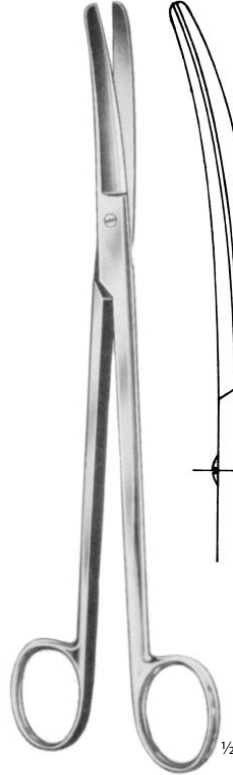

**SIMS**  
**113 91 0123** 20,0 cm **113 91 0127**  
**113 91 0124** 23,0 cm **113 91 0128**



**DUBOIS**  
**113 91 0129**  
 27,0 cm

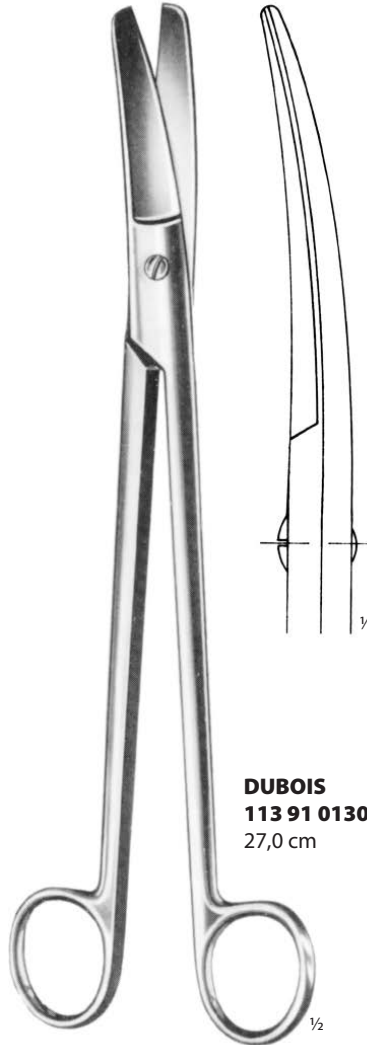

**DUBOIS**  
**113 91 0130**  
 27,0 cm

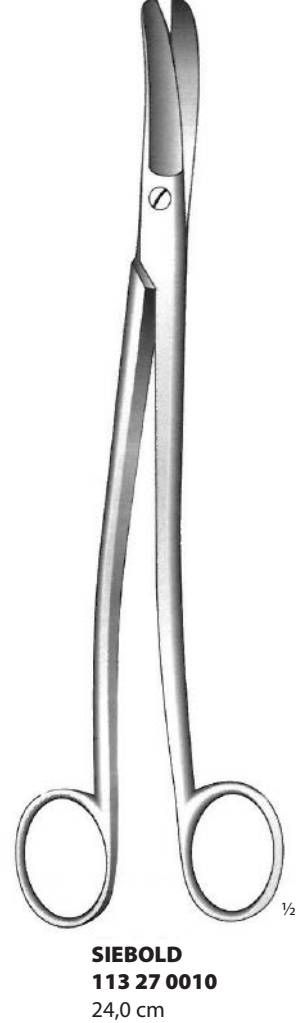

**SIEBOLD**  
**113 27 0010**  
 24,0 cm



**METZENBAUM**  
**113 91 0133**  
rovné  
straight  
14,5 cm

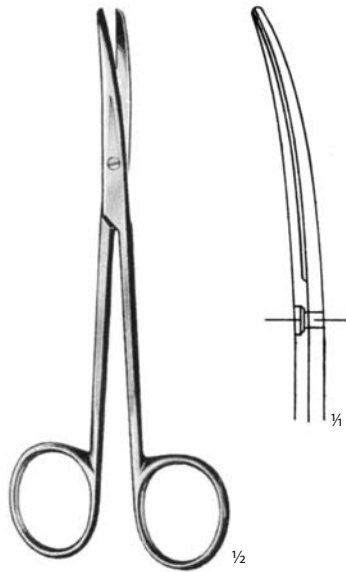

**METZENBAUM**  
**113 91 0135**  
zahnuté  
curved  
14,5 cm



**METZENBAUM**  
**113 91 0139**  
rovné  
straight  
14,5 cm

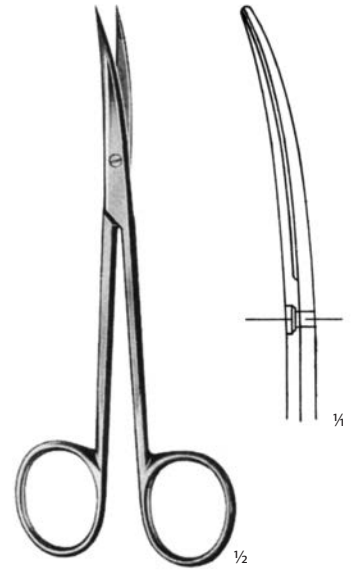

**METZENBAUM**  
**113 91 0140**  
zahnuté  
curved  
14,5 cm

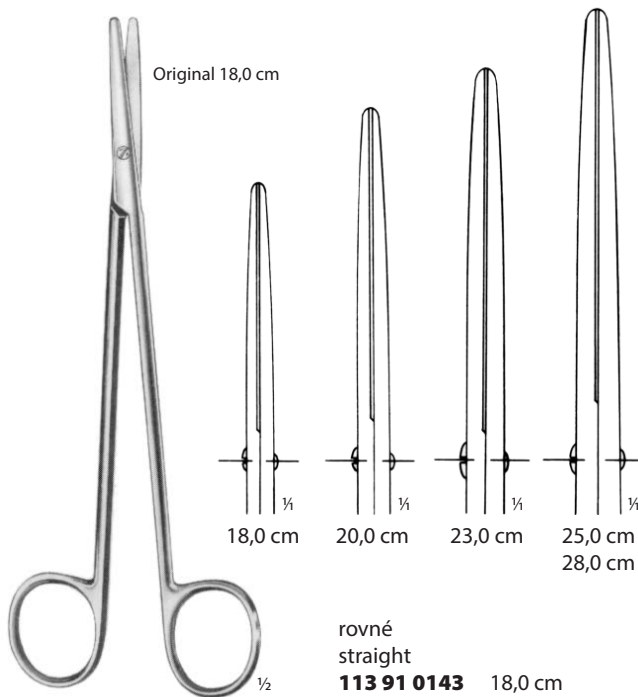

**METZENBAUM-NELSON**

rovné  
straight  
**113 91 0143** 18,0 cm  
**113 91 0145** 20,0 cm  
**113 91 0147** 23,0 cm  
**113 91 0149** 25,0 cm  
**113 91 0150** 28,0 cm

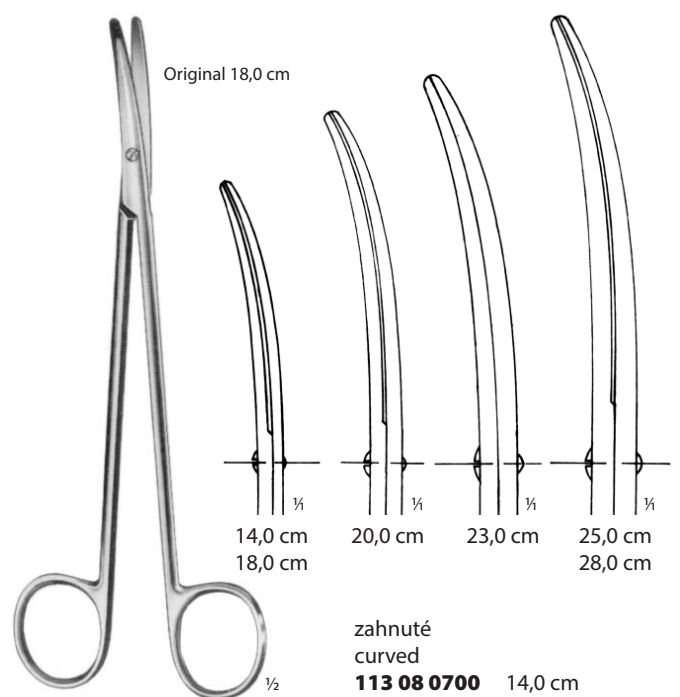

**METZENBAUM-NELSON**

zahnuté  
curved  
**113 08 0700** 14,0 cm  
**113 91 0152** 18,0 cm  
**113 91 0154** 20,0 cm  
**113 91 0156** 23,0 cm  
**113 91 0158** 25,0 cm  
**113 91 0159** 28,0 cm

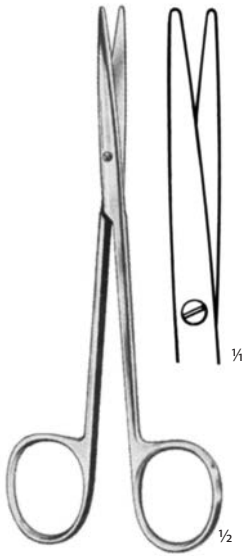

**METZENBAUM-DELICATE**  
**113 91 0185**  
rovné  
straight  
14,5 cm

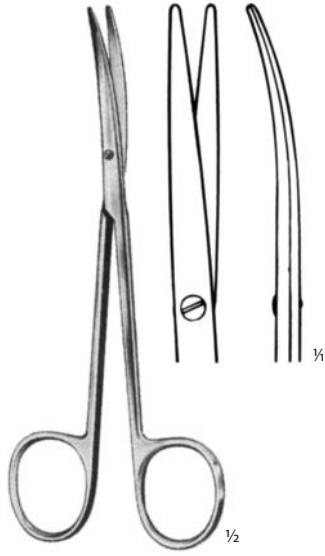

**METZENBAUM-DELICATE**  
**113 91 0186**  
zahnuté  
curved  
14,5 cm

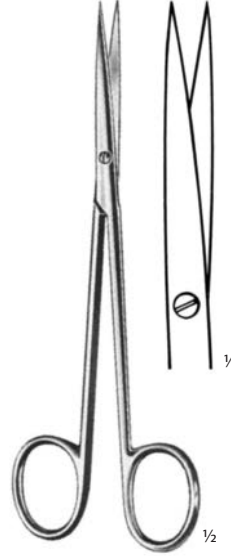

**METZENBAUM-DELICATE**  
**113 91 0187**  
rovné  
straight  
14,5 cm

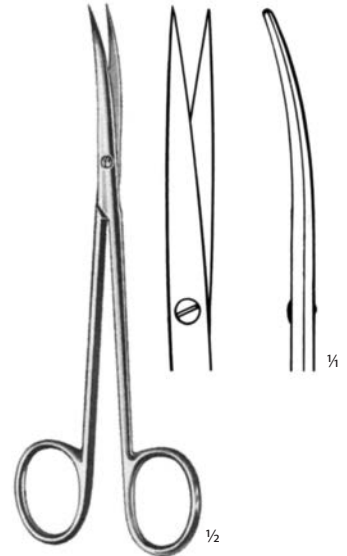

**METZENBAUM-DELICATE**  
**113 91 0188**  
zahnuté  
curved  
14,5 cm

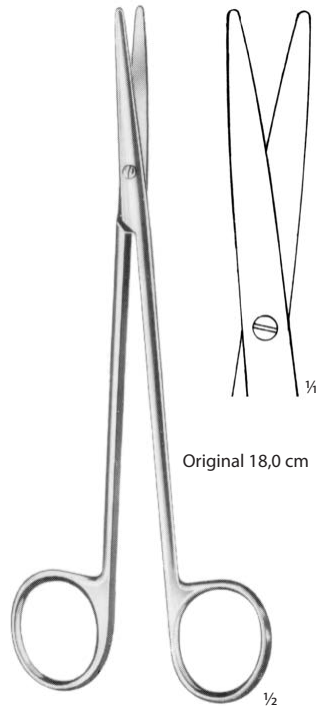

**METZENBAUM-DELICATE**  
rovné  
straight  
**113 91 0189** 18,0 cm  
**113 91 0190** 20,0 cm  
**113 91 0191** 23,0 cm  
**113 91 0192** 25,0 cm

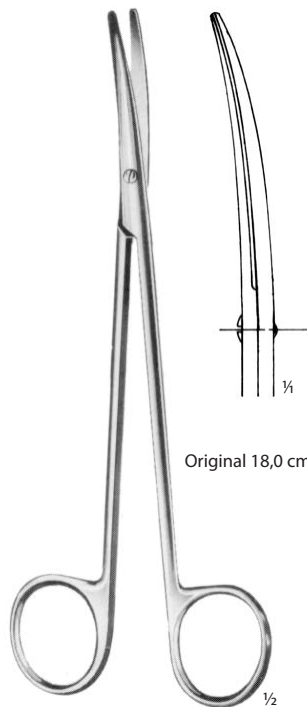

zahnuté  
curved  
**113 91 0195** 18,0 cm  
**113 91 0196** 20,0 cm  
**113 91 0197** 23,0 cm  
**113 91 0198** 25,0 cm

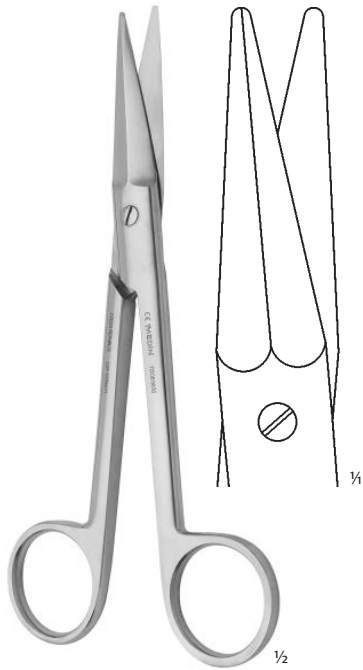

**MAYO**  
**113 08 0830**  
rovné  
straight  
17,0 cm



**MAYO**  
**113 08 0840**  
zahnuté  
curved  
16,8 cm

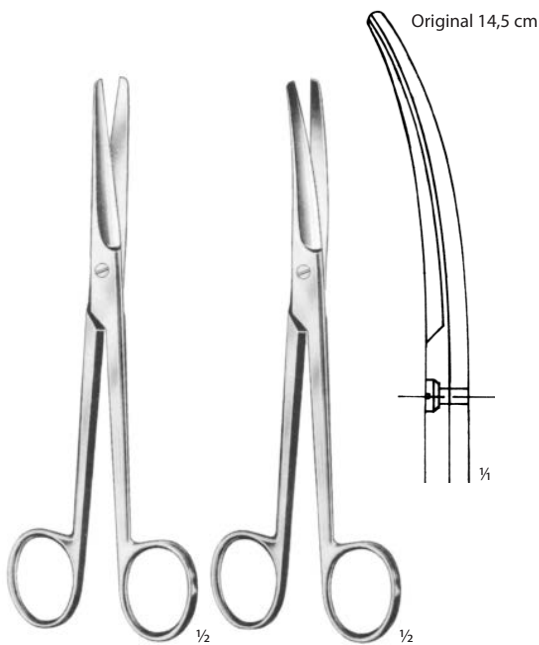

<b>MAYO</b>			
rovné		zahnuté	
straight		curved	
<b>113 91 0083</b>	14,5 cm	<b>113 91 0090</b>	14,5 cm
<b>113 91 0087</b>	23,0 cm	<b>113 91 0094</b>	23,0 cm

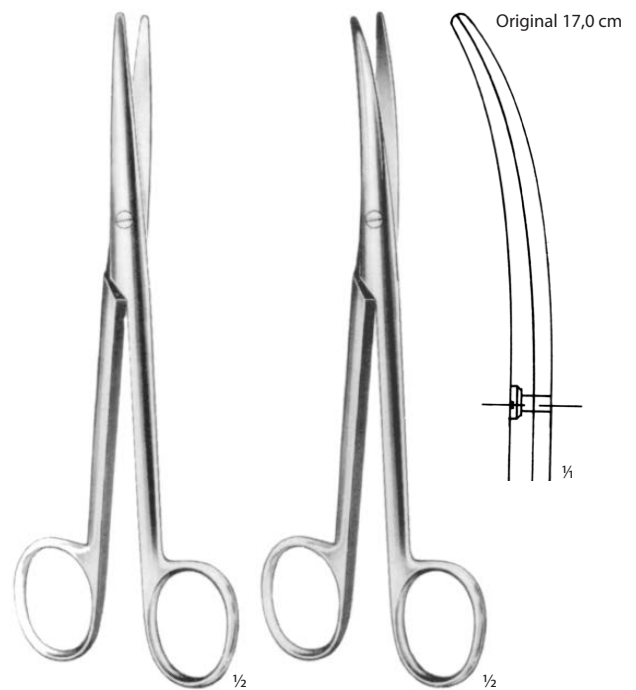

<b>MAYO-STILLE</b>			
rovné		zahnuté	
straight		curved	
<b>113 91 0097</b>	15,0 cm	<b>113 91 0101</b>	15,0 cm
<b>113 91 0098</b>	17,0 cm	<b>113 91 0102</b>	17,0 cm

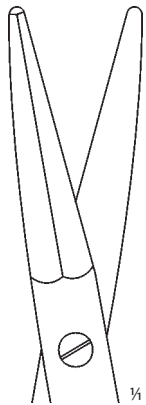

**113 08 0880**  
rovné  
straight  
18,5 cm



**113 08 0890**  
zahnuté  
curved  
18,5 cm

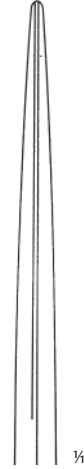
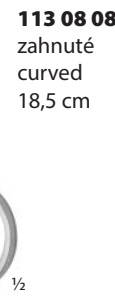

**113 08 0930**  
rovné  
straight  
17,0 cm

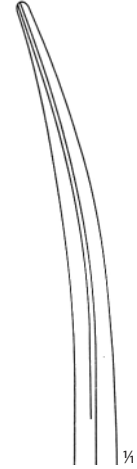

**113 08 0940**  
zahnuté  
curved  
17,0 cm

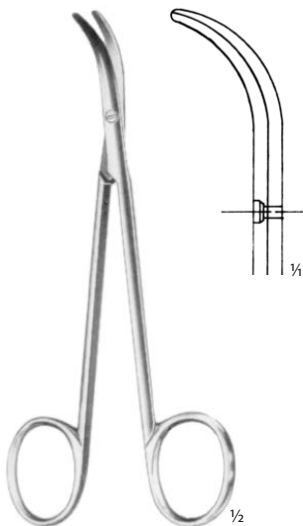
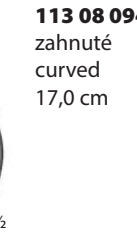

**FOMON**  
**113 91 0217**  
13,5 cm

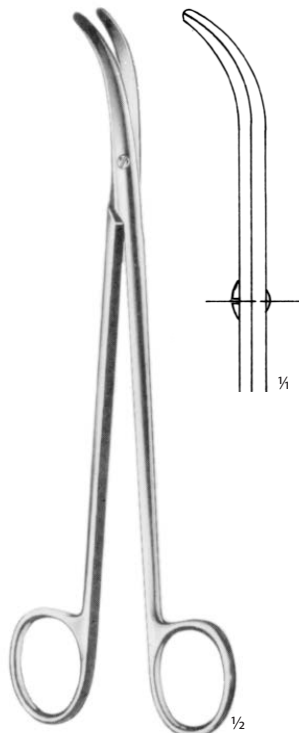

**THOREK**  
**113 91 0218**  
19,0 cm



**LEXER-BABY**  
**113 91 0219**  
rovné  
straight  
10,0 cm

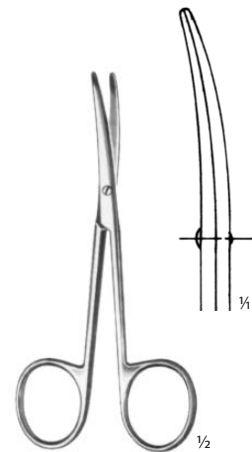

**LEXER-BABY**  
**113 91 0220**  
zahnuté  
curved  
10,0 cm





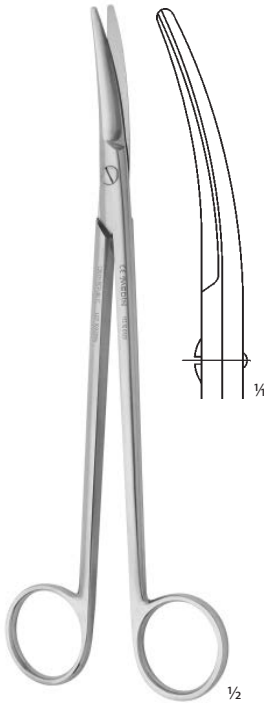

**113 10 0120**  
18,5 cm

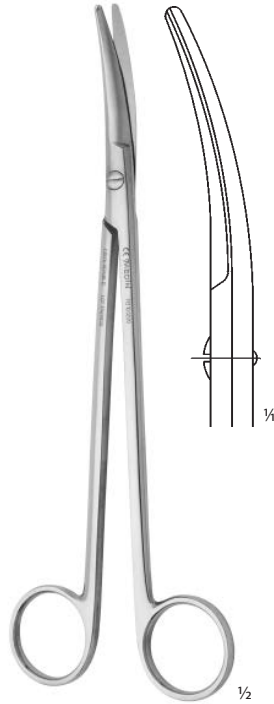

**113 10 0220**  
18,5 cm



**LEXER**  
**113 91 0215**  
16,0 cm

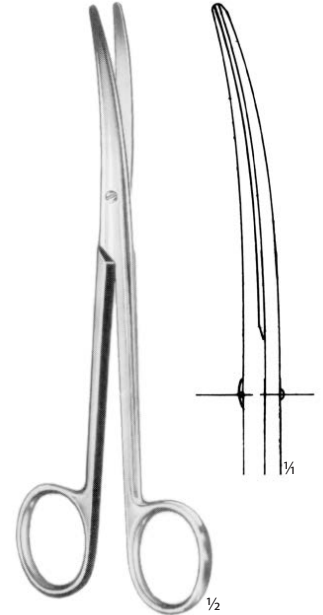

**LEXER**  
**113 91 0216**  
16,0 cm

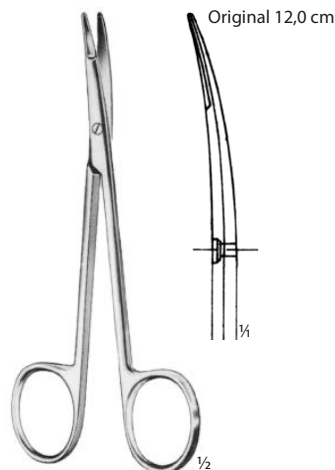

**KILNER (RAGNELL)**  
**113 91 0229** 12,0 cm  
**113 91 0230** 15,0 cm



**SANVENERO**  
rovné  
straight  
**113 91 0221**  
14,0 cm

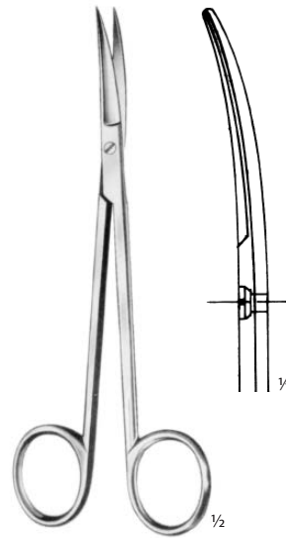

**SANVENERO**  
zahnuté  
curved  
**113 91 0222**  
14,0 cm



**REYNOLDS**  
**113 91 0233**  
rovné  
straight  
15,0 cm

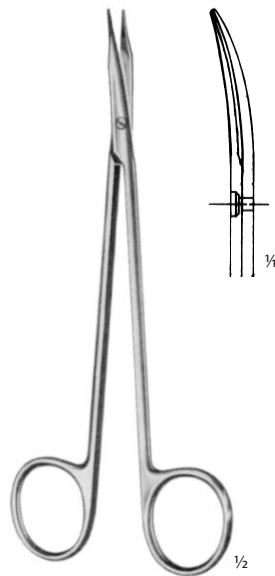

**REYNOLDS**  
**113 91 0235**  
zahnuté  
curved  
15,0 cm

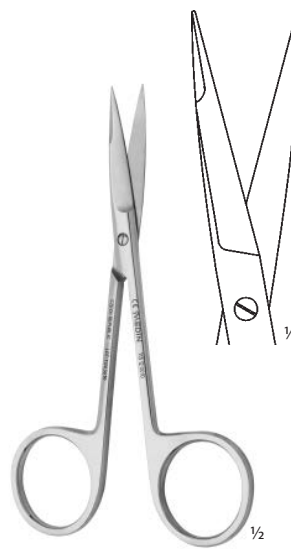

**113 12 0010**  
rovné  
straight  
12,0 cm

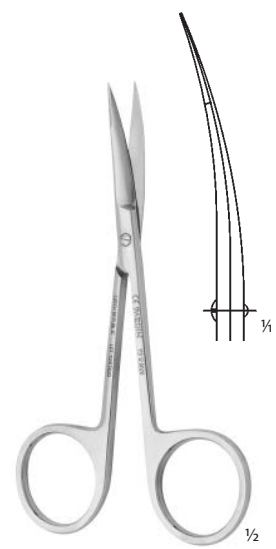

**113 12 0020**  
zahnuté  
curved  
12,0 cm

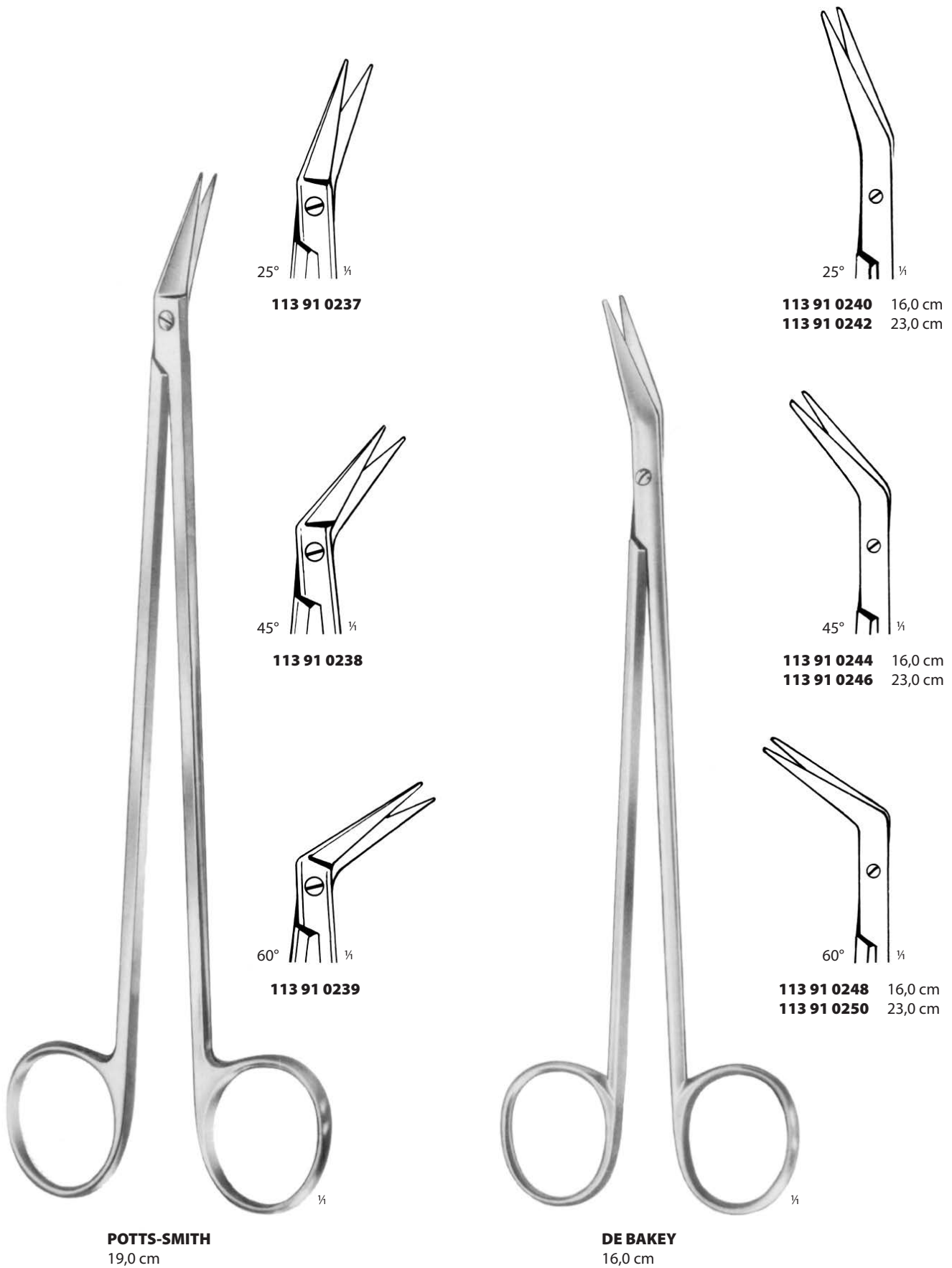

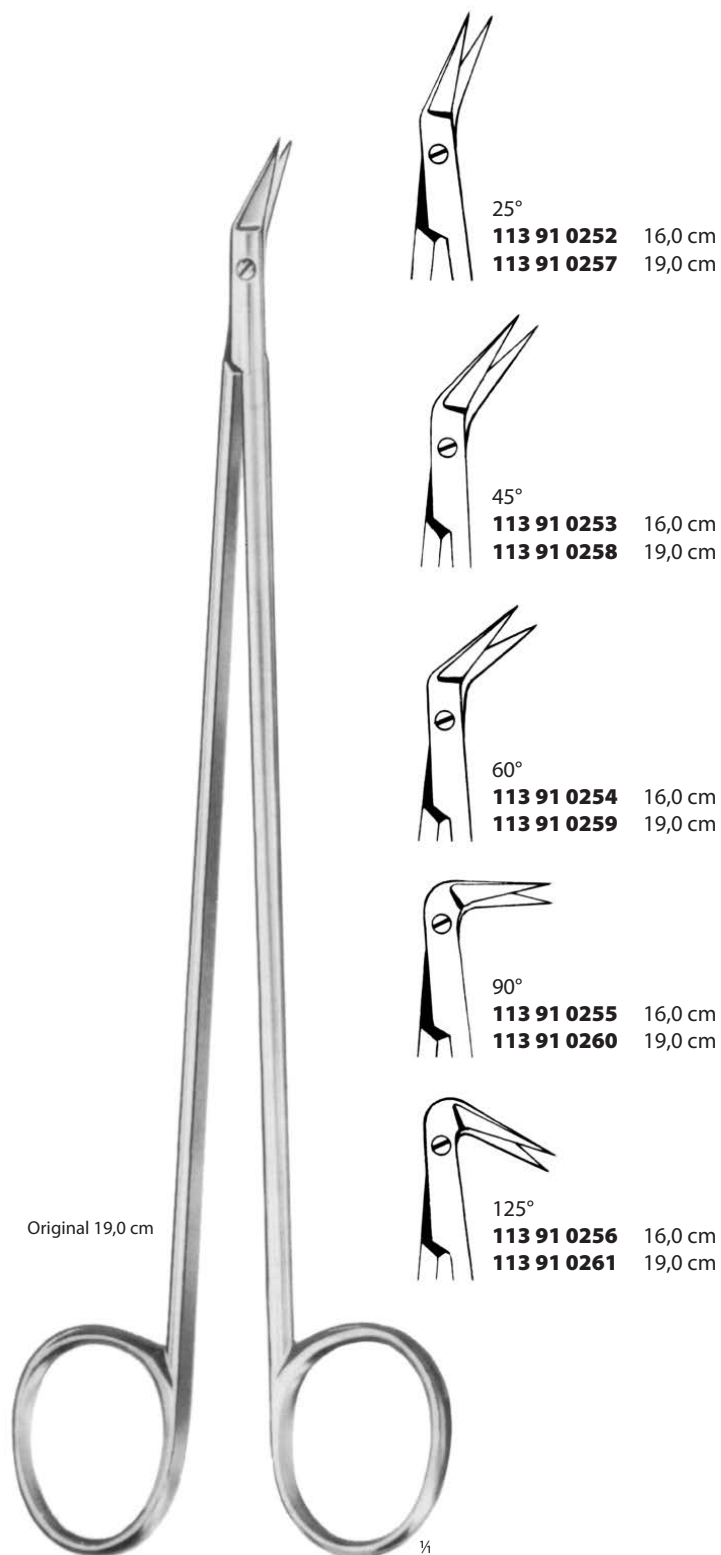

HEGEMANN-DIETRICH

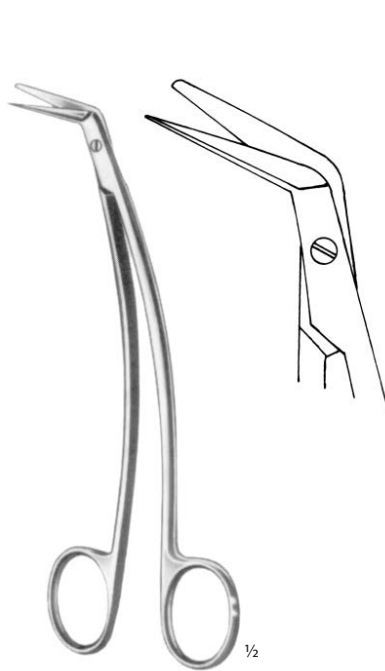

**FAVALORO**  
113 91 0270  
15,0 cm



**SCHMIEDEN-TAYLOR**  
113 91 0275 14,5 cm  
113 91 0276 17,0 cm

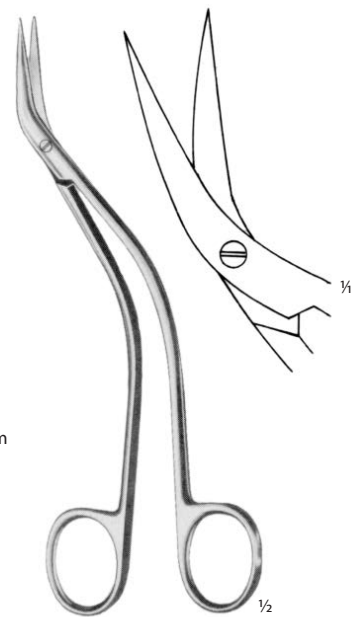

**DE BAKEY**  
113 91 0272  
15,5 cm



**STRULLY**  
113 91 0267  
22,0 cm

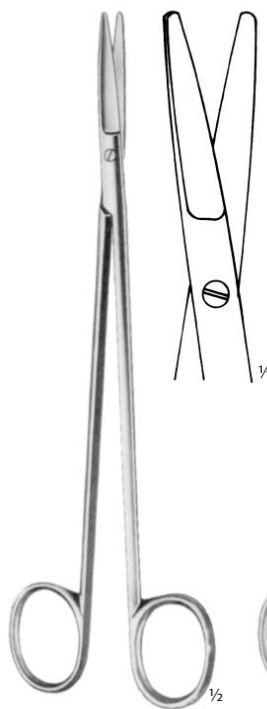

**TOENNIS**  
113 91 0278  
18,0 cm

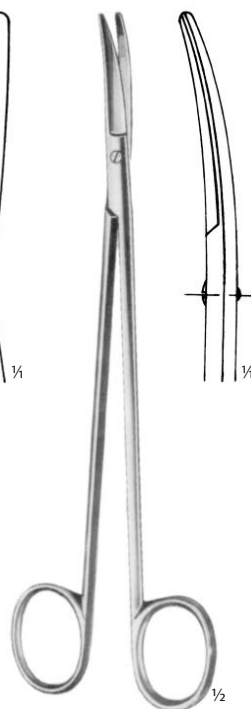

**TOENNIS**  
113 91 0279  
18,0 cm



**POTTS-DE MARTEL**  
113 91 0273  
21,0 cm



**KLINKENBERGH-LOTH**  
**113 91 0280**  
23,0 cm

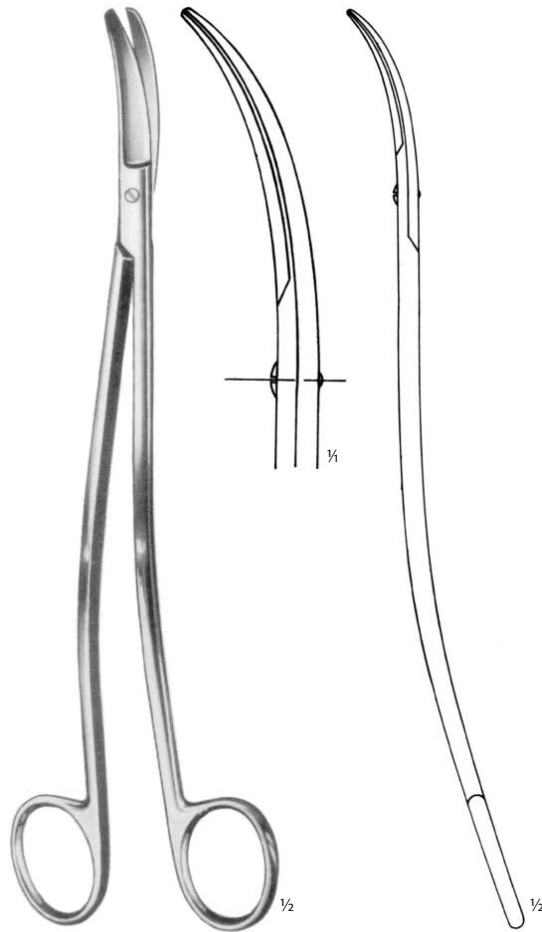

**SATINSKY**  
**113 91 0281**  
24,5 cm

NŮŽKY NA CHRUPAVKU A LOBEKTOMII  
CARTILAGE AND LOBECTOMY SCISSORS



**McINDOE**  
**113 91 0290**  
19,0 cm

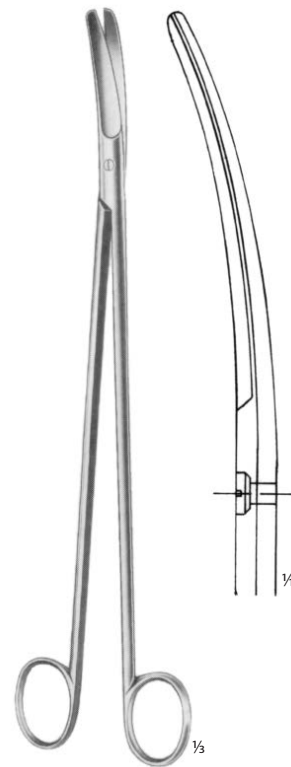

**CRAFOORD**  
**113 91 0292**  
30,0 cm

NŮŽKY NA STŘEVA, ANATOMICKÉ  
ENTERETOMY, DISSECTING SCISSORS



**113 91 0295**  
21,0 cm



**113 91 0296**  
21,0 cm



**113 91 0297**  
11,0 cm



**113 91 0300**  
11,0 cm



**PRINCE**  
**113 32 0010**  
18,5 cm

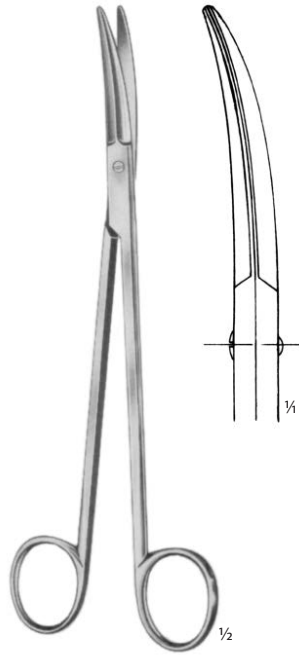

**PRINCE**  
**113 91 0303**  
17,5 cm



**GOOD**  
**113 91 0305**  
19,0 cm

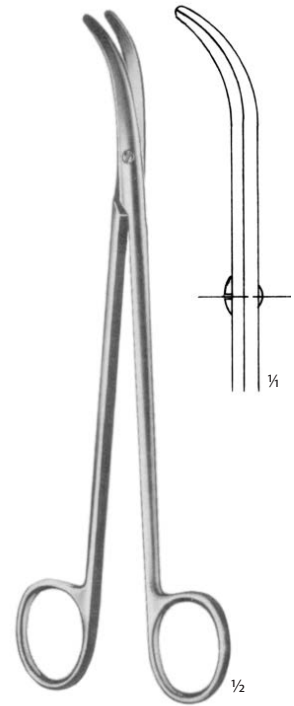

**HALLE**  
**113 91 0312**  
19,0 cm

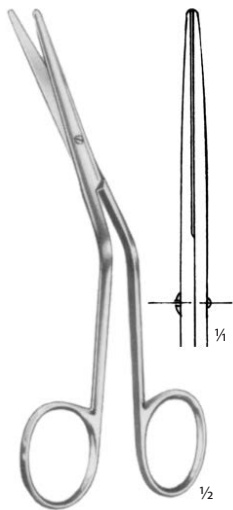

**FOMON**  
**113 91 0311**  
13,5 cm



**HOUGH**  
**113 91 0684**  
13,0 cm

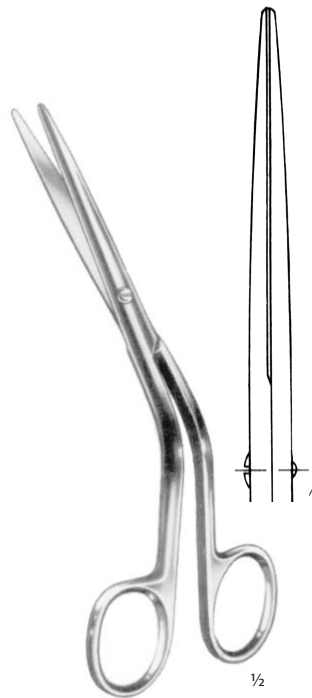

**COTTLE**  
**113 91 0313**  
16,0 cm



**HEYMANN**  
**113 30 0010**  
18,0 cm





10,0 cm  
11,5 cm

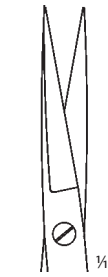

**113 38 0010**  
**113 38 0071**  
hrotnaté rovné  
sharp straight

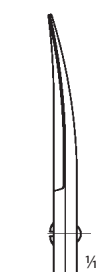

**113 38 0040**  
**113 38 0091**  
hrotnaté zahnuté  
sharp curved

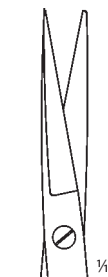

**113 38 0020**  
**113 38 0150**  
hrotnatotupé rovné  
sharp-blunt straight



**113 38 0050**  
**113 38 0100**  
hrotnatotupé zahnuté  
sharp-blunt curved



**113 38 0030**  
**113 38 0081**  
tupé rovné  
blunt straight



**113 38 0060**  
**113 38 0161**  
tupé zahnuté  
blunt curved



**113 38 0210**  
hrotnaté  
sharp  
10,5 cm

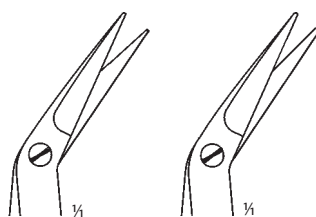

**113 38 0260**  
tupé  
blunt  
10,5 cm

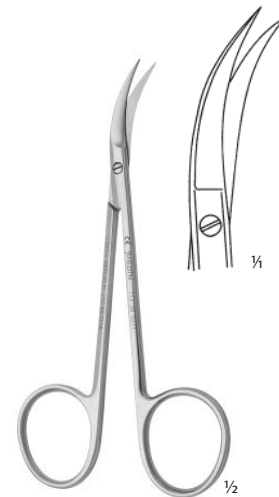

**113 38 0311**  
11,5 cm

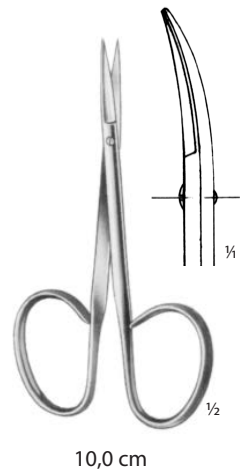
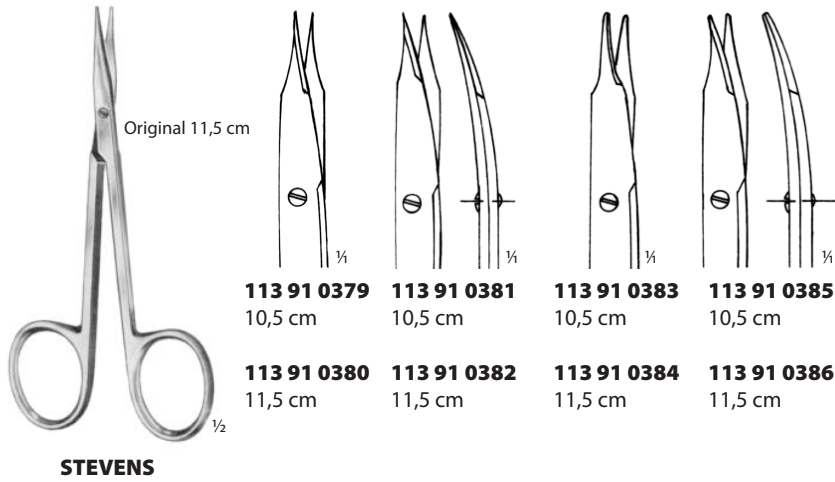

**113 91 0387** rovné ostré  
straight sharp

**113 91 0388** zahnuté ostré  
curved sharp

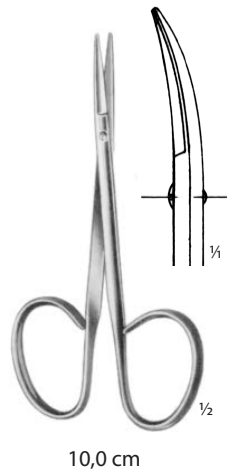

**113 91 0389** rovné tupé  
straight blunt

**113 91 0390** zahnuté tupé  
curved blunt

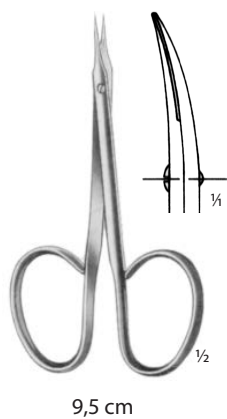

**113 91 0393** rovné ostré  
straight sharp

**113 91 0394** zahnuté ostré  
curved sharp

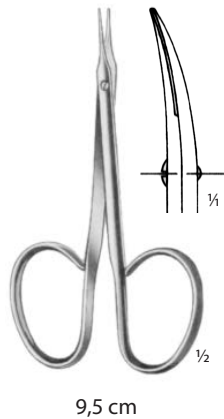

**113 91 0395** rovné tupé  
straight blunt

**113 91 0396** zahnuté tupé  
curved blunt

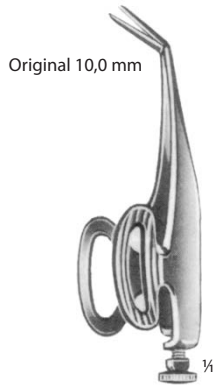

**BARRAQUER**

5,5 cm

**113 91 0499** 5,0 mm

**113 91 0500** 7,0 mm

**113 91 0501** 10,0 mm

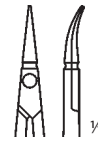

**113 38 1020**

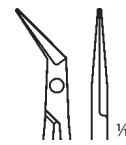

**113 38 1030**



9,0 cm



**113 38 0850**  
rovné  
straight  
12,0 cm



**113 38 0860**  
zahnuté  
curved  
11,0 cm



**NOYES**  
12,0 cm



**113 91 0490**



**113 91 0492**



**113 91 0494**

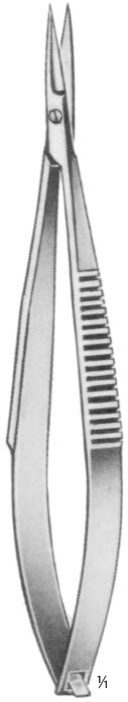

**CASTROVIEJO**  
**113 91 0502**  
9,0 cm



**113 91 0503**

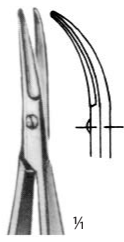

**113 91 0504**



**113 91 0505**



**113 91 0506**

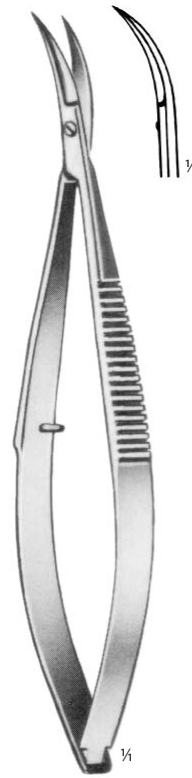

**CASTROVIEJO**  
**113 91 0507**  
10,0 cm

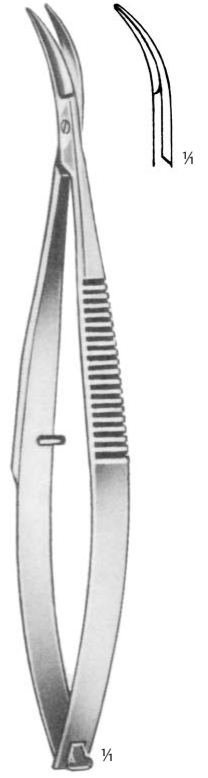

**CASTROVIEJO**  
**113 91 0508**  
10,0 cm

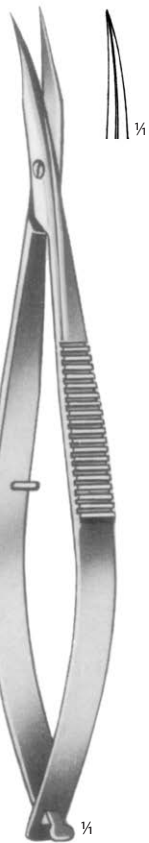

**WESTCOTT**  
**113 91 0518**  
11,0 cm



**WESTCOTT**  
**113 91 0517**  
11,0 cm



**CASTROVIEJO**  
**113 91 0521**  
11,0 cm

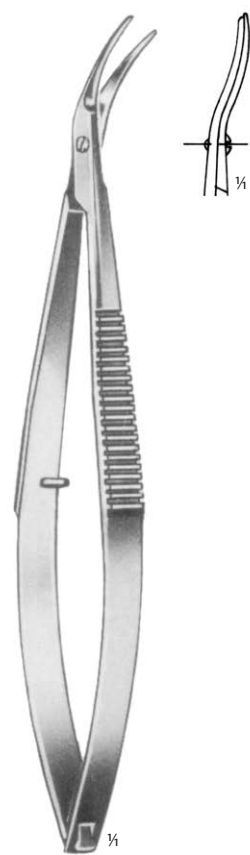

**CASTROVIEJO**  
**113 91 0522**  
11,0 cm



**SPENCER**  
113 91 0399 9,0 cm  
113 91 0400 10,5 cm



**LITTAUER**  
113 91 0403 14,0 cm

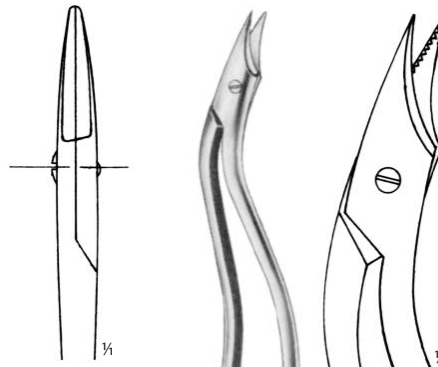

**HEATH**  
113 91 0408 15,0 cm



**NORTHBENT**  
113 91 0411 12,5 cm

**MIKRO NŮŽKY**  
MICRO SCISSORS

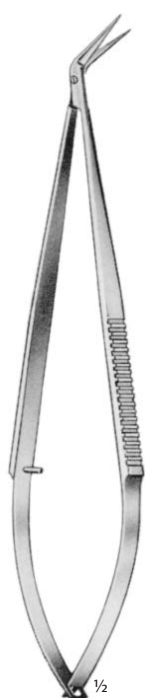

**113 91 0573**  
25°



**113 91 0574**  
45°



**113 91 0575**  
60°

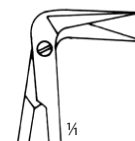

**113 91 0576**  
90°

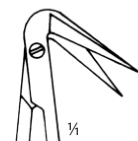

**113 91 0577**  
125°



**113 91 0578**  
25°



**113 91 0579**  
45°

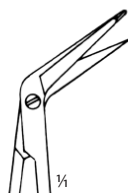

**113 91 0580**  
60°

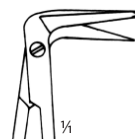

**113 91 0581**  
90°

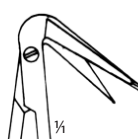

**113 91 0582**  
125°



**GOMEL**  
14,5 cm

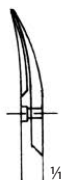

**113 91 0537**



**113 91 0539**



**GOMEL**  
18,0 cm



**113 91 0538**



**113 91 0540**

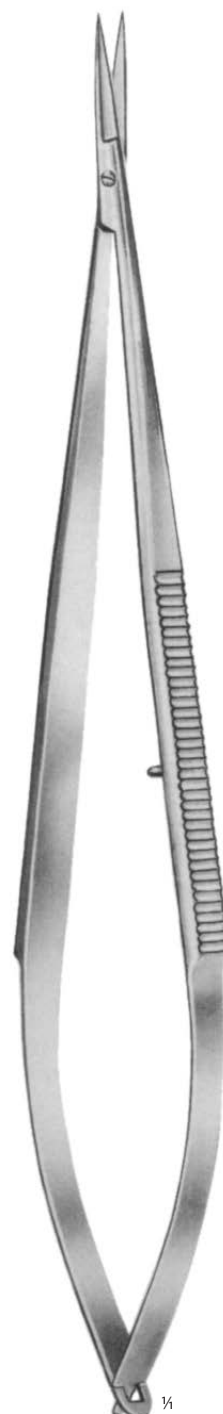

18,5 cm



**113 91 0552**



**113 91 0553**

NŮŽKY NA LÁTKU, NŮŽKY NA VLASY  
CLOTHING SCISSORS, HAIR SCISSORS



Nůžky na měkké obvazy  
Plaster scissors  
**113 05 0210**  
23,0 cm



Nůžky na vlasy  
Hair scissors  
**113 08 1000**  
16,5 cm

NŮŽKY NA OBVAZY  
BANDAGE SCISSORS



sterilizace při  
143°C /290° F  
autoclavable

**UNIVERSAL**  
**113 91 0432**  
18,0 cm

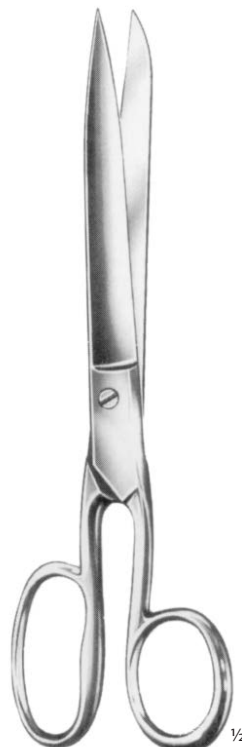

**SMITH (MOD. USA)**  
**113 91 0437**  
20,0 cm



**LORENZ**  
**113 91 0439**  
23,0 cm





Original 16,0 cm

**113 91 0444** 16,0 cm  
**113 91 0445** 19,0 cm

**LISTER-EXCENTRIC**  
se zuby  
saw edge



Original 18,0 cm

**113 91 0446** 9,0 cm  
**113 91 0447** 11,0 cm  
**113 91 0448** 14,0 cm  
**113 05 0030** 16,0 cm  
**113 91 0450** 18,0 cm  
**113 05 0040** 20,0 cm

**LISTER**



Original 20,0 cm

**113 91 0452** 20,0 cm  
**113 91 0453** 22,0 cm

**ESMARCH**



**SEUTIN**  
**113 91 0454**  
23,0 cm



**113 91 0455**  
se zuby  
saw edge  
20,0 cm



**BRUNS**  
**113 91 0456** se zuby  
saw edge  
23,0 cm  
**113 91 0457** hladký  
smooth  
23,0 cm



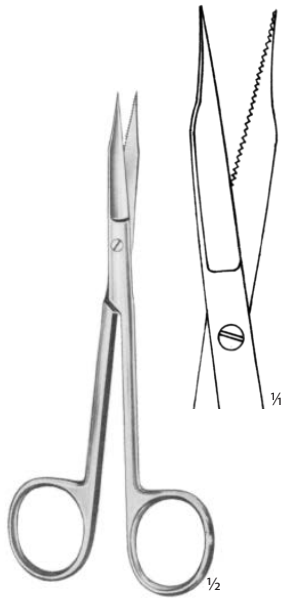

**GOLDMANN-FOX**  
**113 91 0474**  
rovné se zuby  
saw edge straight  
13,0 cm

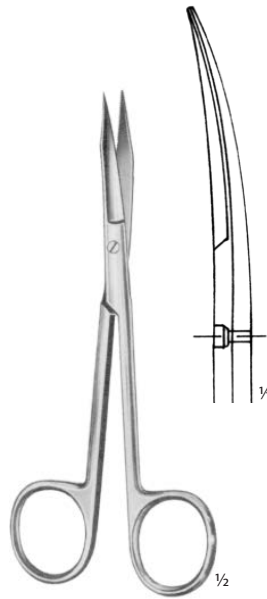

**113 91 0475**  
zahnuté se zuby  
saw edge curved  
13,0 cm

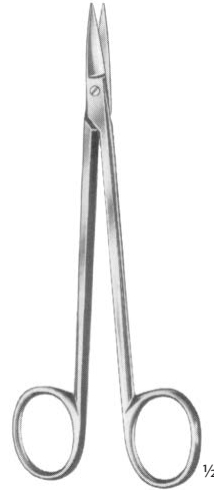

**QUINBY**  
**113 91 0483**  
rovné  
straight  
12,0 cm

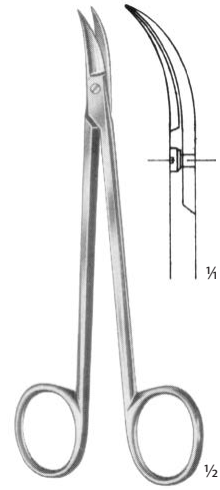

**113 91 0484**  
zahnuté  
curved  
12,0 cm

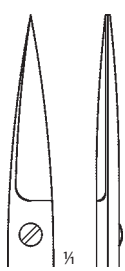

**113 50 0010**  
rovné  
straight  
12,0 cm

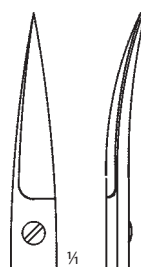

**113 50 0020**  
zahnuté  
curved  
12,0 cm



**113 50 0030**  
rovné  
straight  
14,5 cm

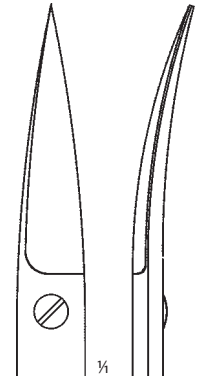

**113 50 0040**  
zahnuté  
curved  
14,5 cm



**113 91 0458** 9,0 cm  
**113 91 0459** 10,5 cm

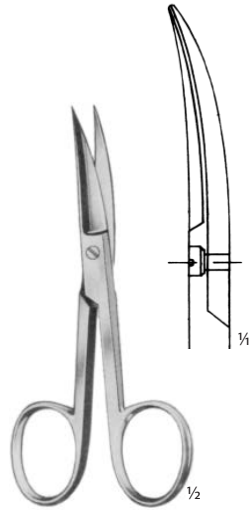

**113 91 0460** 9,0 cm  
**113 91 0461** 10,5 cm



**113 91 0462** 9,0 cm  
**113 91 0463** 10,5 cm

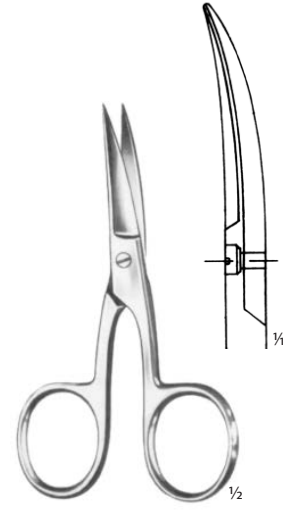

**113 91 0464** 9,0 cm  
**113 91 0465** 10,5 cm



**113 91 0466** 10,0 cm  
**113 91 0467** 11,0 cm

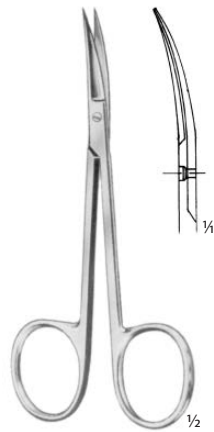

**113 91 0468** 10,0 cm  
**113 91 0469** 11,0 cm



**113 91 0470**  
10,5 cm



**KÖNIG**  
**113 91 0472**  
13,0 cm

**113 91 0473**  
15,0 cm



**STANDARD  
SUPER CUT**  
**113 91 0022**  
rovné hrotnatopé  
straight sharp-blunt  
14,5 cm

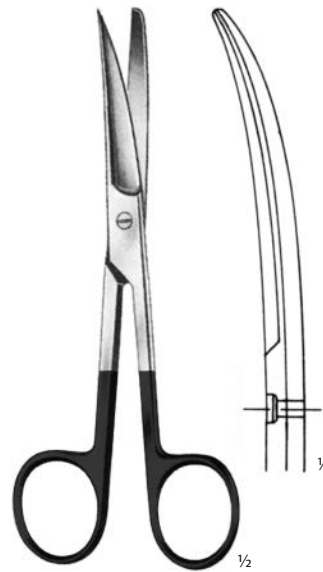

**STANDARD  
SUPER CUT**  
**113 91 0024**  
zahnuté hrotnatopé  
curved sharp-blunt  
14,5 cm



**MAYO  
SUPER CUT**  
**113 91 0084** 14,5 cm  
**113 91 0086** 17,0 cm  
**113 91 0088** 23,0 cm

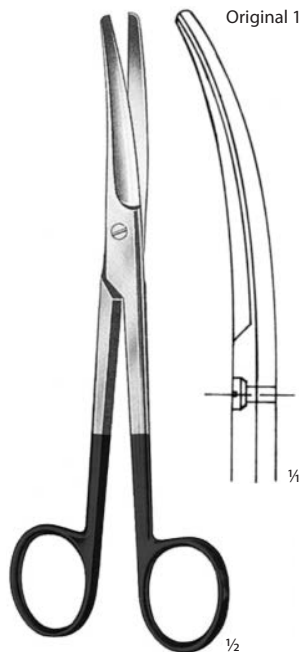

**MAYO  
SUPER CUT**  
**113 91 0091** 14,5 cm  
**113 91 0093** 17,0 cm  
**113 91 0095** 23,0 cm

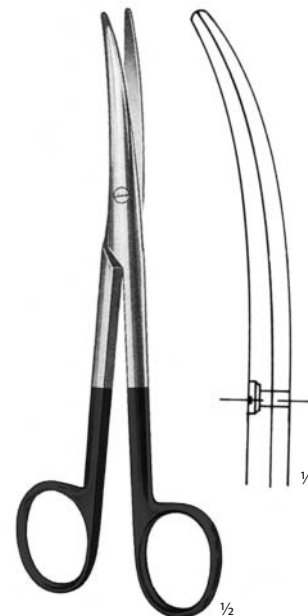

**MAYO-STILLE  
SUPER CUT**  
**113 91 0739** 17,0 cm

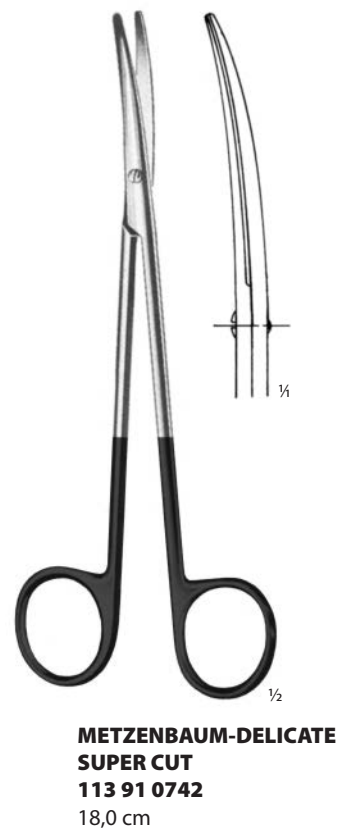
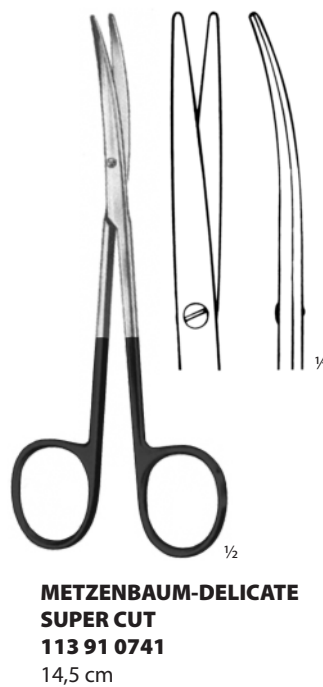
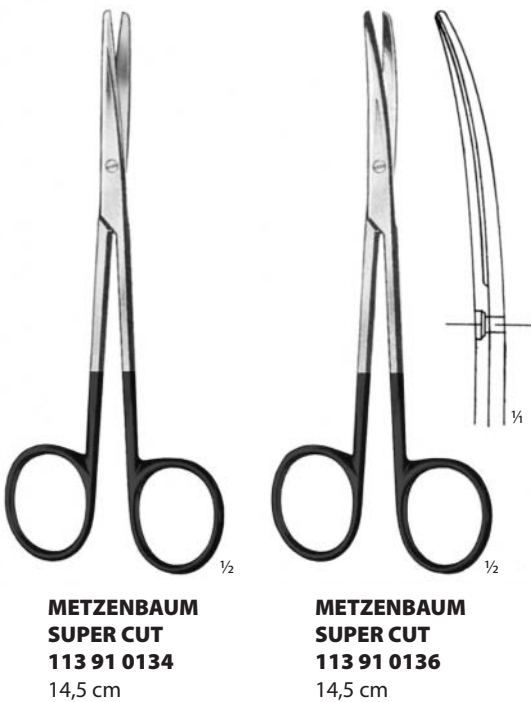
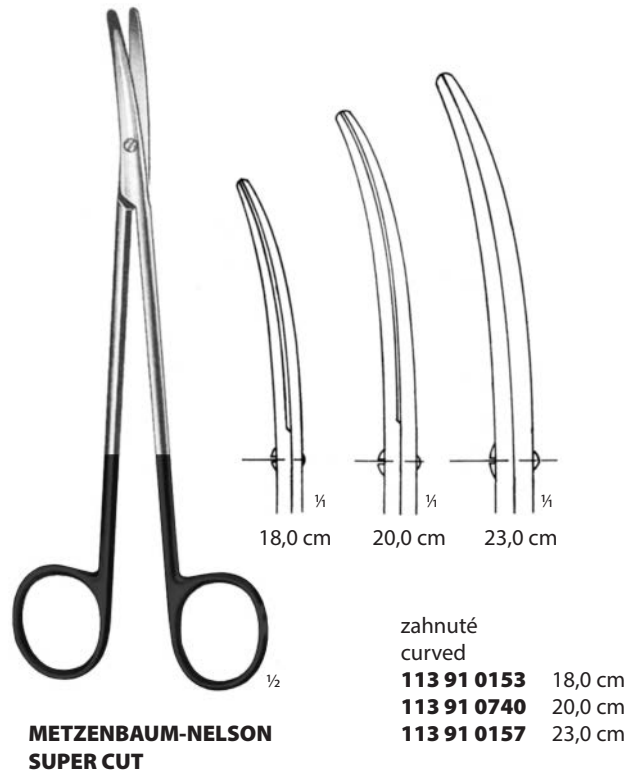
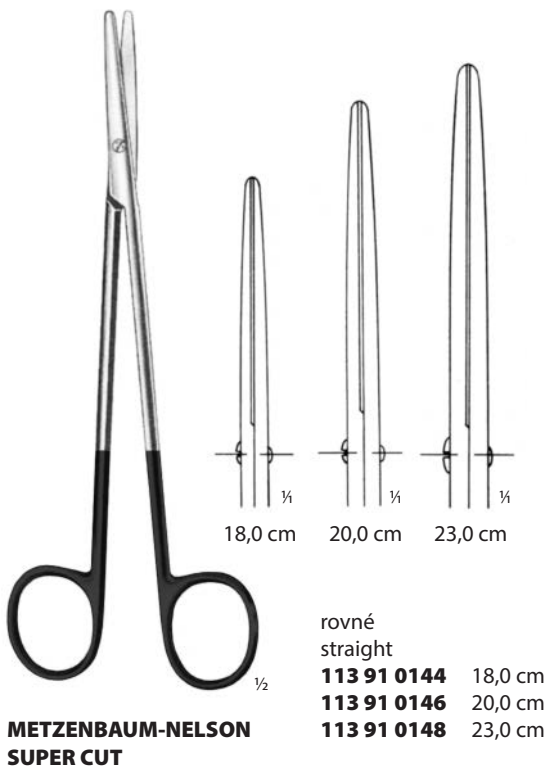



**REYNOLDS  
SUPER CUT**  
**113 91 0743** 15,0 cm  
**113 91 0745** 18,0 cm



**113 91 0364**  
11,5 cm

Nůžky na duhovku  
Iris scissors  
**SUPER CUT**



**113 91 0368**  
11,5 cm

Nůžky na duhovku  
Iris scissors  
**SUPER CUT**

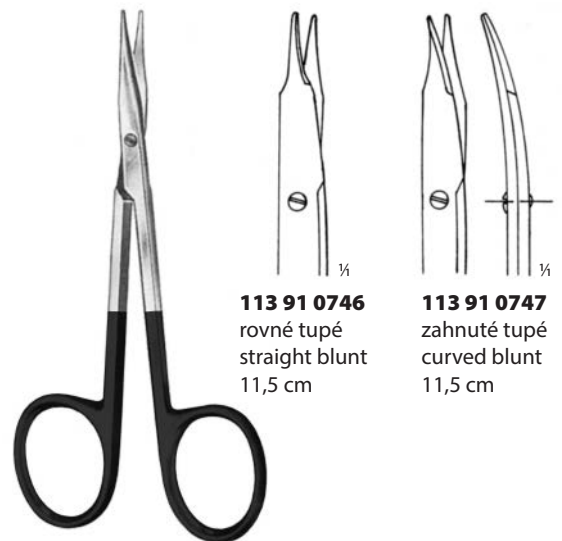

**113 91 0746**  
rovné tupé  
straight blunt  
11,5 cm

**113 91 0747**  
zahnuté tupé  
curved blunt  
11,5 cm

**STEVENS  
SUPER CUT**

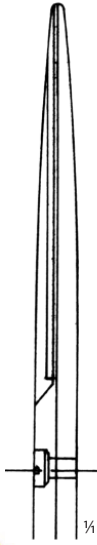

**113 91 0601**  
**113 91 0602**  
**113 91 0603**

**MAYO**



Original 17,0 cm

14,5 cm  
17,0 cm  
23,0 cm



**113 91 0604**  
**113 91 0605**  
**113 91 0606**

**MAYO**



**PARAMETRIUM**

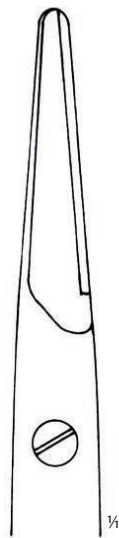

Original 23,0 cm

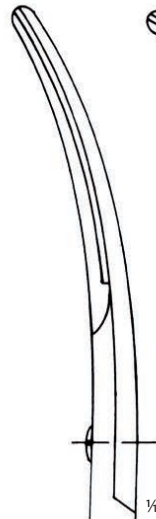

**113 91 0607**  
22,5 cm

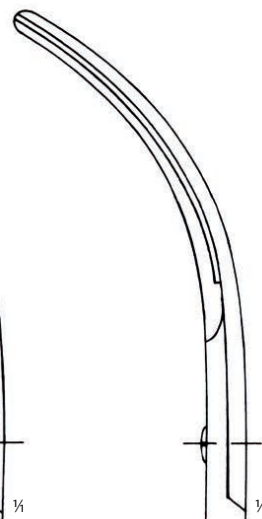

**113 91 0608**  
23,0 cm



MAYO-STILLE

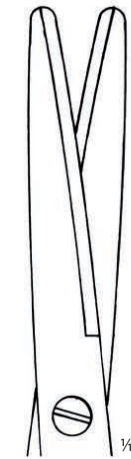

Original 17,0 cm



113 91 0611  
113 91 0612



MAYO-STILLE

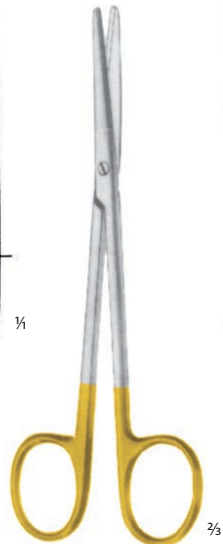
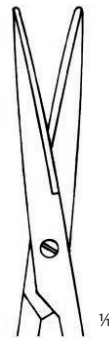
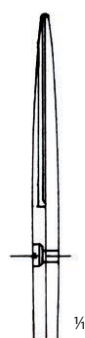

113 91 0617

METZENBAUM  
11,5 cm

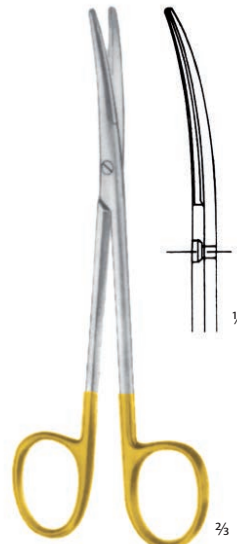

113 91 0618

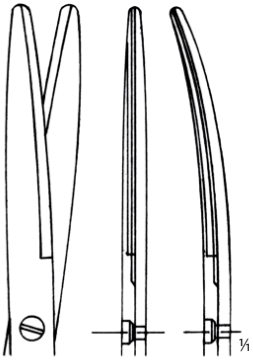

Original 18,0 cm

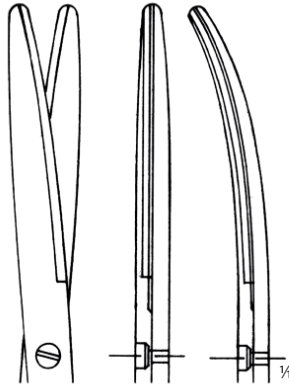

Original 20,0 cm

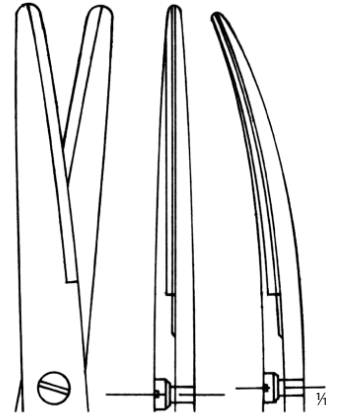

Original 23,0 cm



Original 18,0 cm



**METZENBAUM**

rovné  
straight

- 113 91 0621** 18,0 cm
- 113 91 0622** 20,0 cm
- 113 91 0623** 23,0 cm
- 113 91 0624** 25,0 cm
- 113 91 0625** 28,0 cm

zahnuté  
curved

- 113 91 0627**
- 113 91 0628**
- 113 91 0629**
- 113 91 0630**
- 113 91 0631**

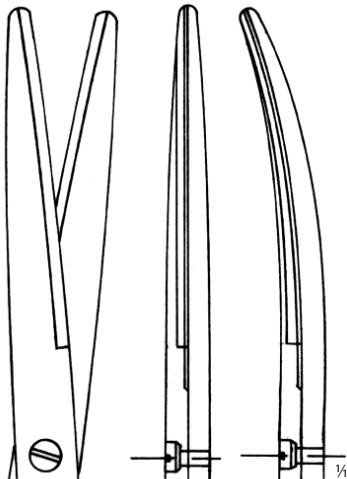

Original 25,0 cm

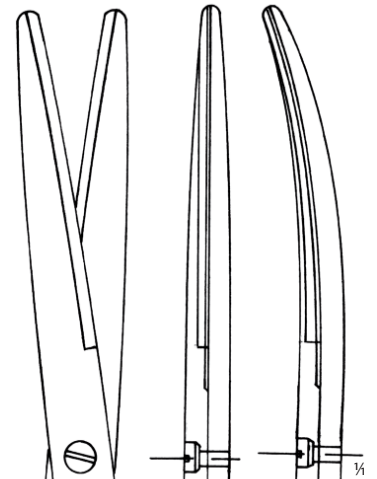

Original 28,0 cm





**113 91 0633**  
25°

**113 91 0634**  
45°

**113 91 0635**  
60°

**POTTS-SMITH**  
19,0 cm



**113 91 0636**  
25°

**113 91 0637**  
45°

**113 91 0638**  
60°

**DE BAKÉY**  
18,0 cm



**METZENBAUM-DELICATE**  
**113 91 0641**  
14,5 cm



**METZENBAUM-DELICATE**  
**113 91 0642**  
14,5 cm



**METZENBAUM-DELICATE**  
**113 91 0643**  
14,5 cm



**METZENBAUM-DELICATE**  
**113 91 0644**  
14,5 cm

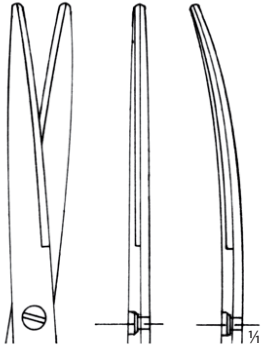

Original 18,0 cm

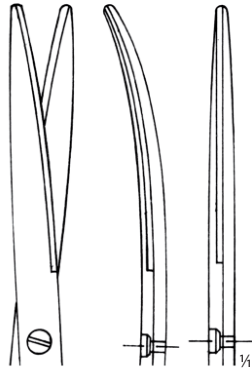

Original 20,0 cm

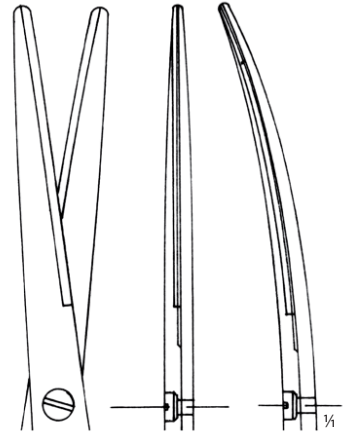

Original 23,0 cm



Original 18,0 cm

**METZENBAUM - DELICATE**

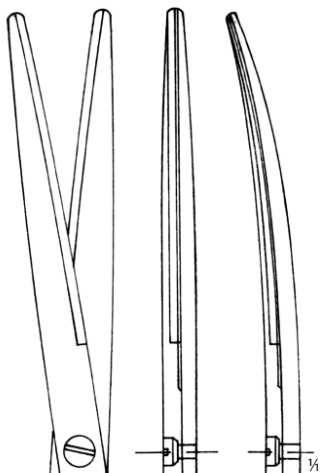

Original 25,0 cm

rovné  
straight

- 113 91 0645** 18,0 cm
- 113 91 0646** 20,0 cm
- 113 91 0647** 23,0 cm
- 113 91 0648** 25,0 cm
- 113 91 0649** 28,0 cm

zahnuté  
curved

- 113 91 0650**
- 113 91 0651**
- 113 91 0652**
- 113 91 0653**
- 113 91 0654**

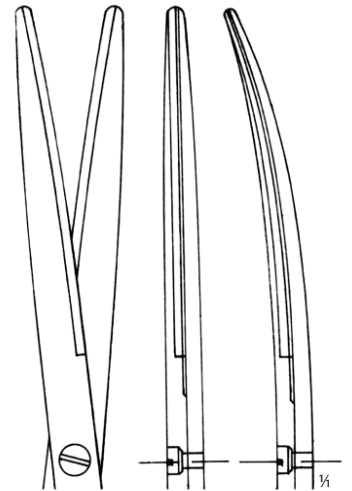

Original 28,0 cm

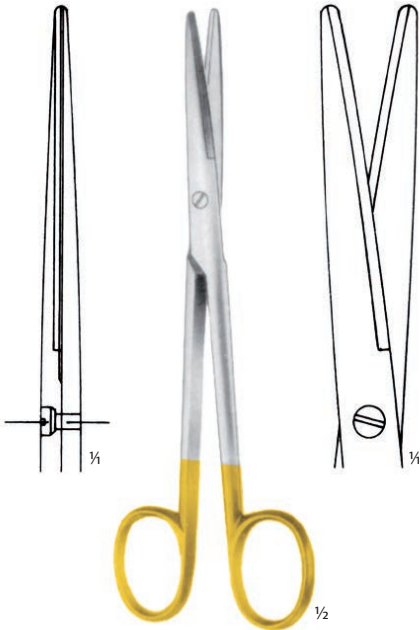

**LEXER**  
**113 91 0639**  
16,0 cm



**LEXER**  
**113 91 0640**  
16,0 cm

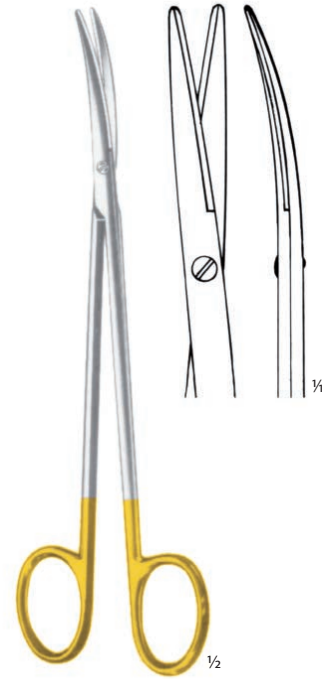

**TOENNIS-ADSON-DELICATE**  
**113 91 0665**  
17,5 cm

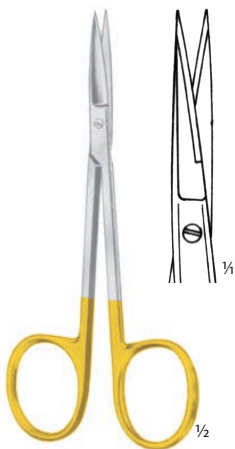

**113 91 0668**  
11,5 cm

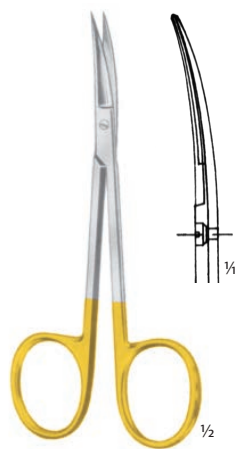

**113 91 0669**  
11,5 cm

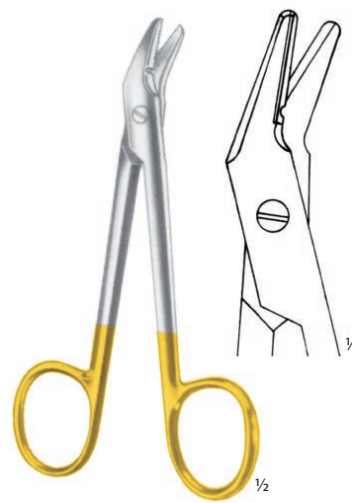

**UNIVERSAL**  
**113 91 0670**  
12,0 cm



**LISTER**  
**113 91 0671**  
18,0 cm

NŮŽKY TVRDOKOVOVÉ SUPER CUT  
SCISSORS SUPER CUT WITH TUNGSTEN CARBIDE INSERT



**MAYO  
SUPER CUT**  
113 91 0748 14,5 cm  
113 91 0749 17,0 cm



**MAYO  
SUPER CUT**  
113 91 0750 14,5 cm  
113 91 0751 17,0 cm



**MAYO-STILLE  
SUPER CUT**  
113 91 0752  
15,0 cm

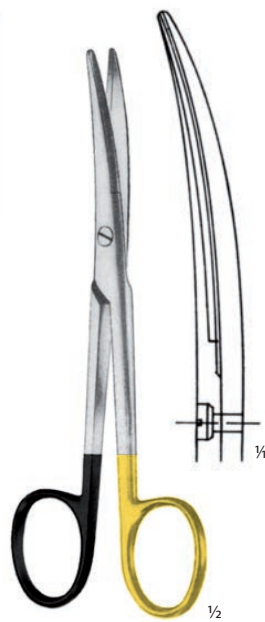

**MAYO-STILLE  
SUPER CUT**  
113 91 0753  
15,0 cm



**METZENBAUM  
SUPER CUT**  
113 91 0754  
14,5 cm



**METZENBAUM  
SUPER CUT**  
113 91 0767  
14,5 cm

NŮŽKY TVRDOKOVOVÉ SUPER CUT  
SCISSORS SUPER CUT WITH TUNGSTEN CARBIDE INSERT

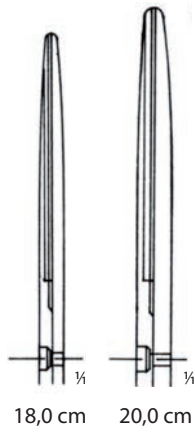

rovné  
straight  
**113 91 0768** 18,0 cm  
**113 91 0769** 20,0 cm

**METZENBAUM  
SUPER CUT**



zahnuté  
curved  
**113 91 0770** 18,0 cm  
**113 91 0771** 20,0 cm  
**113 91 0772** 23,0 cm  
**113 91 0773** 25,0 cm

**METZENBAUM  
SUPER CUT**

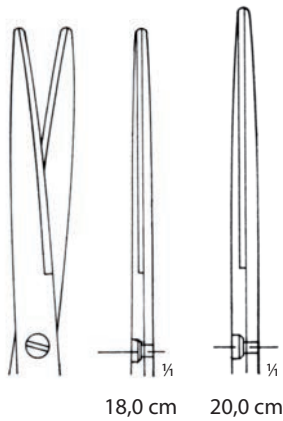

rovné  
straight  
**113 91 0776** 18,0 cm  
**113 91 0777** 20,0 cm

**METZENBAUM-DELICATE  
SUPER CUT**



zahnuté  
curved  
**113 91 0778** 18,0 cm  
**113 91 0779** 20,0 cm

**METZENBAUM-DELICATE  
SUPER CUT**





**METZENBAUM-DELICATE  
SUPER CUT**  
**113 91 0774**  
14,5 cm



**METZENBAUM-DELICATE  
SUPER CUT**  
**113 91 0775**  
14,5 cm



**113 91 0782**  
11,5 cm

Nůžky na duhovku  
Iris scissors  
**SUPER CUT**



**113 91 0783**  
11,5 cm

Nůžky na duhovku  
Iris scissors  
**SUPER CUT**



**113 91 0780**  
rovnné hrotnaté  
straight pointed  
11,5 cm

**STEVENS  
SUPER CUT**

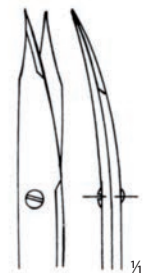

**113 91 0781**  
zahnuté hrotnaté  
curved pointed  
11,5 cm

# 114

## PINZETY FORCEPS







PINZETY PRO PLASTICKOU CHIRURGII  
FORCEPS FOR PLASTIC SURGERY



**KUEHNE**  
**114 02 0010**  
10,5 cm



**114 12 0010**  
14,0 cm



**114 12 0020**  
20,0 cm



**114 12 0030**  
11,0 cm

PINZETY EPILAČNÍ  
DEPILATION FORCEPS

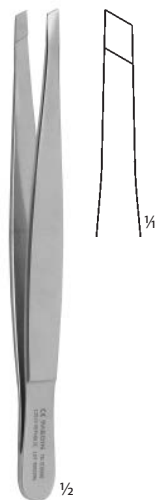

**114 12 0090**  
13,0 cm



**114 12 0100**  
14,0 cm

## PINZETY ANATOMICKÉ DRESSING FORCEPS

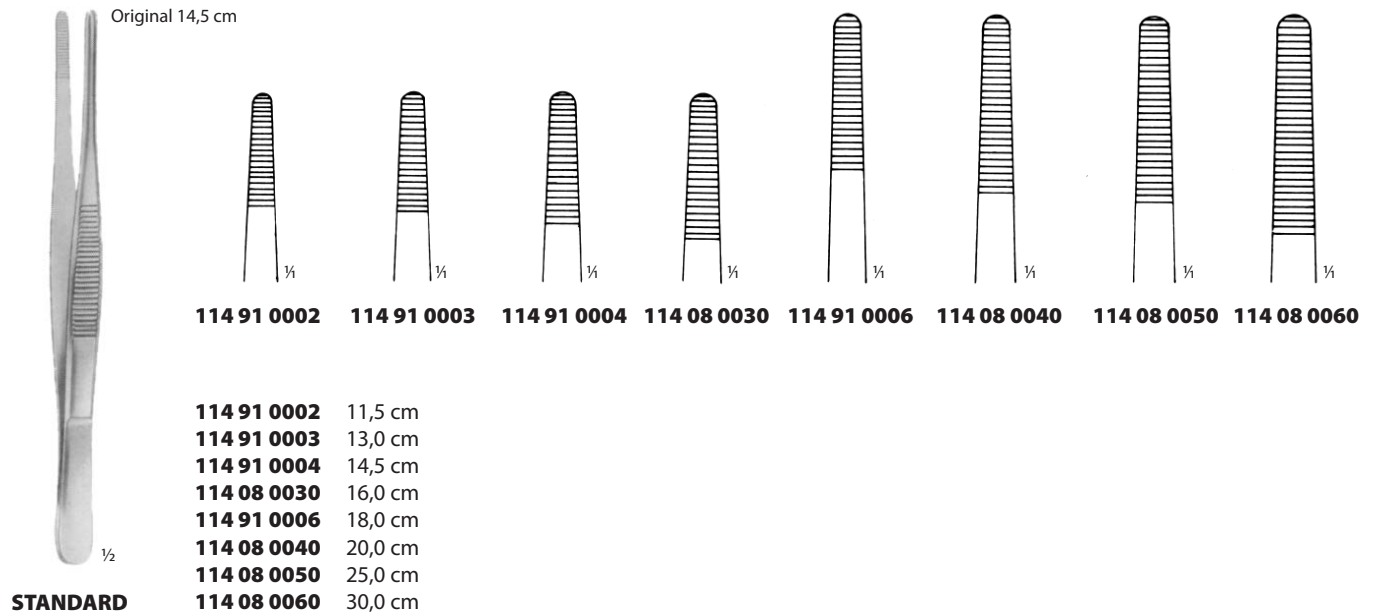

## PINZETY CHIRURGICKÉ TISSUE FORCEPS

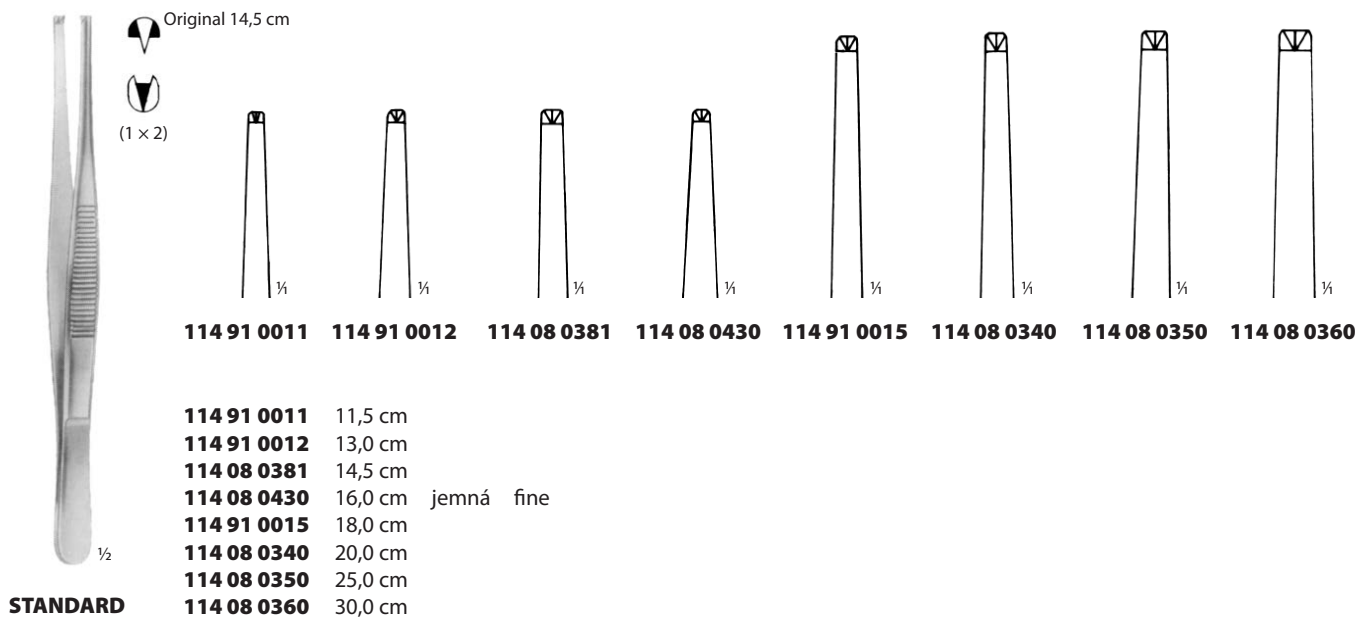

PINZETY CHIRURGICKÉ, ANATOMICKÉ  
DRESSING FORCEPS, TISSUE FORCEPS



- 114 91 0019** 13,0 cm
- 114 91 0020** 14,5 cm
- 114 91 0021** 16,0 cm
- 114 91 0022** 18,0 cm
- 114 91 0023** 20,0 cm
- 114 91 0024** 25,0 cm



- 114 91 0026** 13,0 cm
- 114 91 0027** 14,5 cm
- 114 91 0028** 16,0 cm



- 114 91 0029** 13,0 cm
- 114 91 0030** 14,5 cm
- 114 91 0031** 16,0 cm

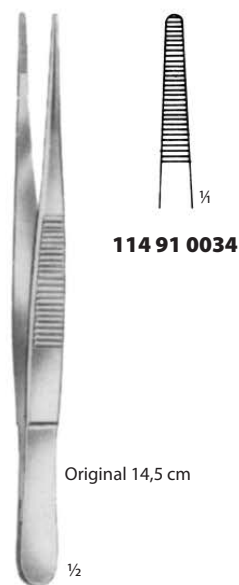

- 114 91 0033** 11,5 cm
- 114 91 0034** 13,0 cm
- 114 91 0036** 16,0 cm
- 114 91 0037** 18,0 cm
- 114 91 0038** 20,0 cm
- 114 91 0039** 25,0 cm
- 114 91 0040** 30,0 cm



**114 08 0090**  
14,5 cm



**114 08 0101**  
jemná  
fine  
14,5 cm



**114 08 0231**  
velmi jemná  
very fine  
14,5 cm



**114 08 0140**  
jemná  
fine  
20,0 cm



**114 08 0240**  
velmi jemná  
very fine  
20,0 cm



**114 08 0250**  
24,5 cm



**114 08 0530**  
velmi jemná  
very fine  
14,5 cm



**114 08 0540**  
20,0 cm

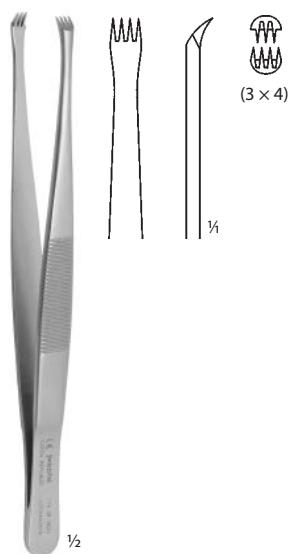

**114 08 0620**  
14,0 cm

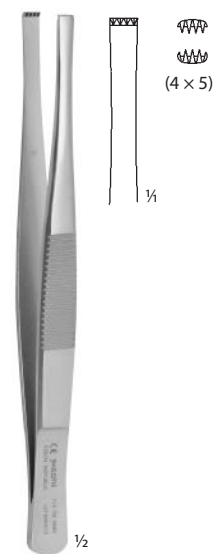

**114 08 0660**  
14,0 cm

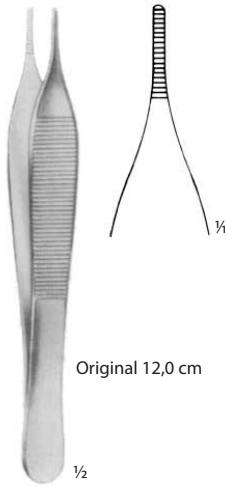

**ADSON**  
114 91 0105 12,0 cm  
114 91 0107 15,0 cm

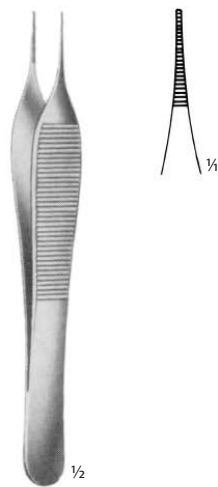

**MICRO-ADSON**  
114 91 0108 12,0 cm

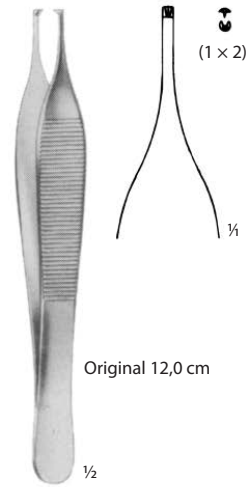

**ADSON**  
114 91 0111 12,0 cm  
114 91 0113 15,0 cm

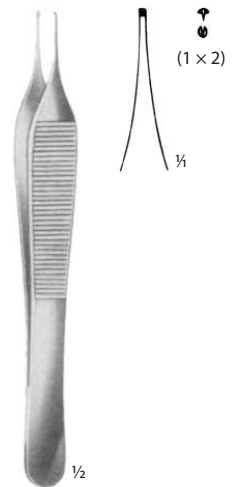

**MICRO-ADSON**  
114 91 0114 12,0 cm



**ADSON-BROWN**  
114 91 0119 12,0 cm



**McINDOE**  
114 91 0126 15,0 cm

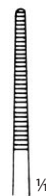

**SEMKEN**  
114 91 0128 12,5 cm 114 91 0132  
114 91 0129 15,5 cm 114 91 0133

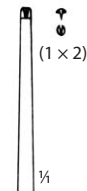



**CUSHING**  
**114 91 0152**  
17,5 cm

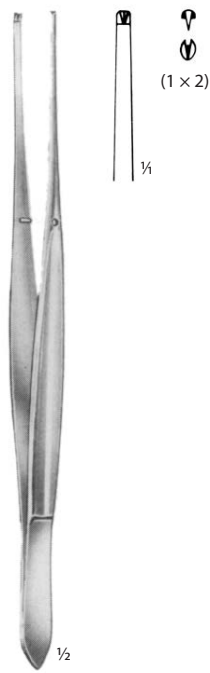

**CUSHING**  
**114 91 0154**  
17,5 cm



**TAYLOR**  
**114 91 0138**  
17,5 cm



**TAYLOR**  
**114 91 0139**  
17,5 cm



**TAYLOR**  
**114 91 0142**  
17,5 cm



**TAYLOR**  
**114 91 0143**  
17,5 cm

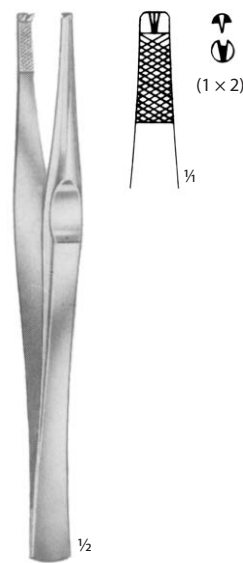

**LANE**  
**114 91 0144**  
14,5 cm

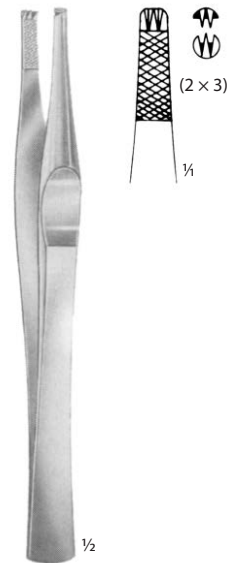

**LANE**  
**114 91 0146**  
14,5 cm

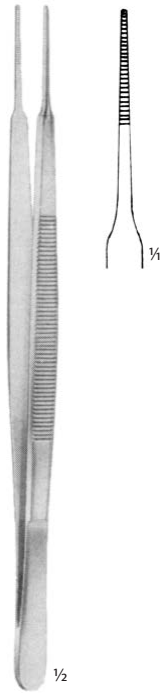

**GERALD**  
**114 91 0148**  
18,0 cm

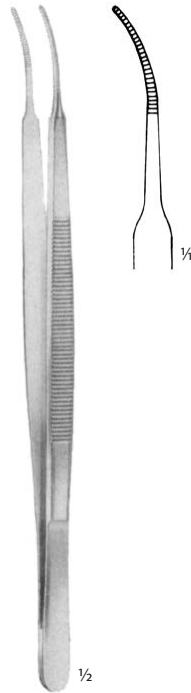

**GERALD**  
**114 91 0149**  
18,0 cm

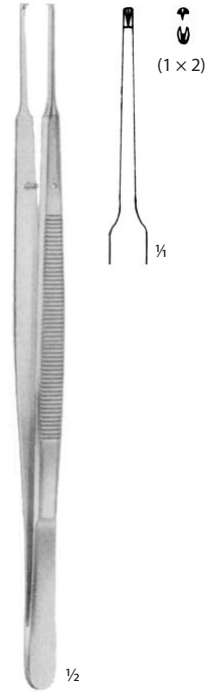

**GERALD**  
**114 91 0150**  
18,0 cm

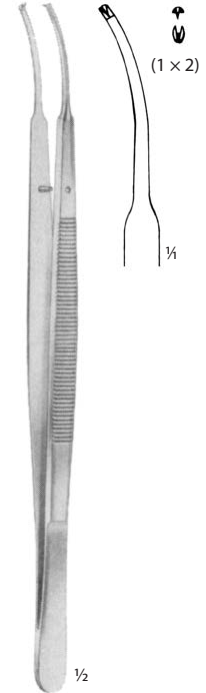

**GERALD**  
**114 91 0151**  
18,0 cm

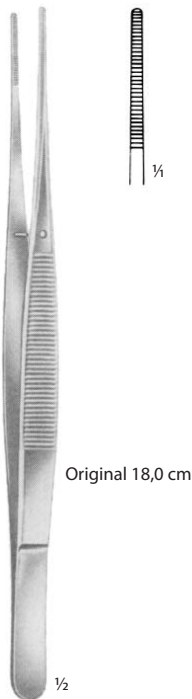

**POTTS-SMITH**  
**114 91 0156** 18,0 cm  
**114 91 0157** 21,0 cm  
**114 91 0158** 25,0 cm



**POTTS-SMITH**  
**114 91 0162** 18,0 cm  
**114 91 0163** 21,0 cm  
**114 91 0164** 25,0 cm



**BROWN**  
**114 91 0172** 15,0 cm  
**114 91 0173** 20,0 cm  
**114 91 0174** 25,0 cm





**WANGENSTEEN**  
**114 91 0179**  
23,0 cm



**STILLE-BARRAYA**  
**114 91 0180** 18,0 cm  
**114 91 0181** 20,0 cm  
**114 91 0182** 25,0 cm



**COLLIN-DUVAL**  
**114 91 0193**  
20,0 cm

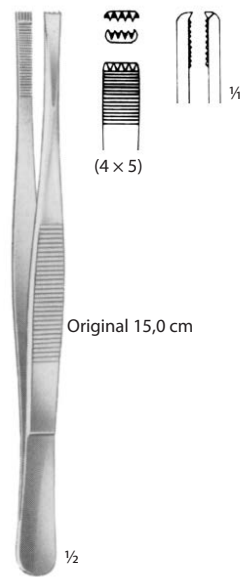

**ADLERKREUTZ**  
**114 91 0190** 15,0 cm  
**114 91 0191** 20,0 cm

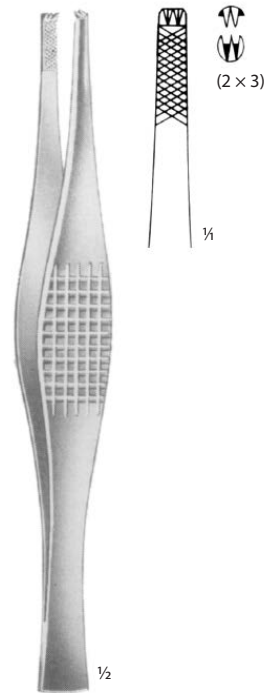

**FERRIS-SMITH**  
**114 91 0183**  
18,0 cm



**SINGLEY-TUTTLE**  
**114 91 0198**  
23,0 cm

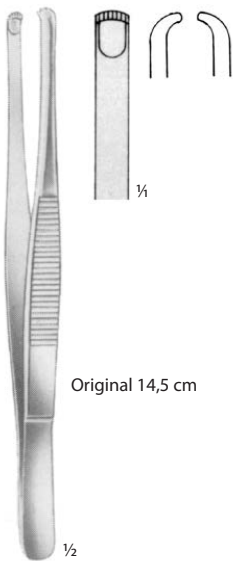

**DURANTE**  
**114 91 0211** 14,5 cm  
**114 91 0212** 16,0 cm  
**114 91 0213** 20,0 cm



**NELSON**  
**114 91 0199**  
23,0 cm

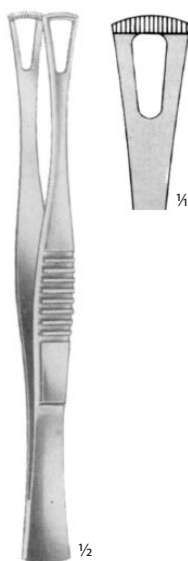

**DUVAL**  
**114 91 0214**  
14,5 cm



**GILLIES**  
**114 91 0200**  
15,0 cm

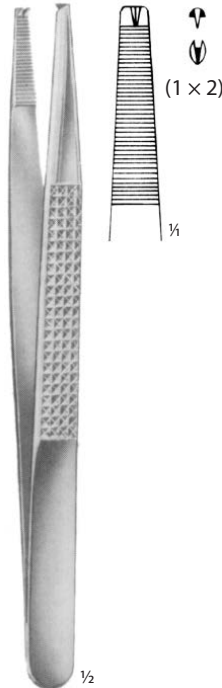

**BONNEY**  
**114 91 0215**  
18,0 cm



**RUSS. MODELL**  
**114 91 0208** 15,0 cm  
**114 91 0209** 20,0 cm  
**114 91 0210** 25,0 cm

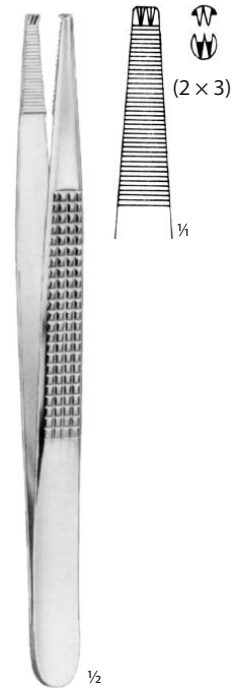

**BONNEY**  
**114 91 0216**  
18,0 cm



**114 91 0228**  
ø 3,0 mm

**114 91 0229**  
ø 5,0 mm

**114 91 0230**  
ø 3,0 mm

**114 91 0231**  
ø 5,0 mm

**YASARGIL**  
22,0 cm

PINZETY ŠÍČÍ  
SUTURING FORCEPS

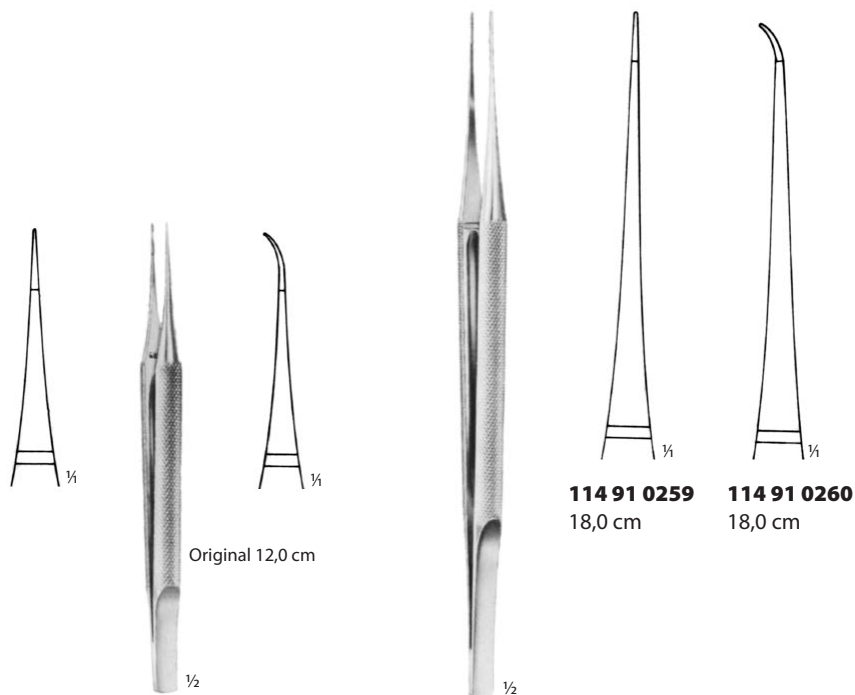

**114 91 0259**  
18,0 cm

**114 91 0260**  
18,0 cm

**114 91 0255** 12,0 cm    **114 91 0257**  
**114 91 0256** 15,0 cm    **114 91 0258**

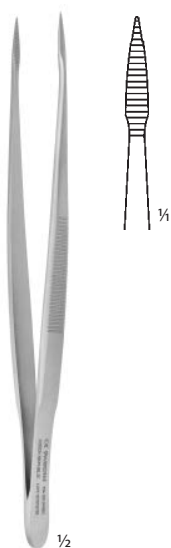
PINZETY NA TŘÍSKY  
SPLINTER FORCEPS

**114 08 0980**  
14,0 cm

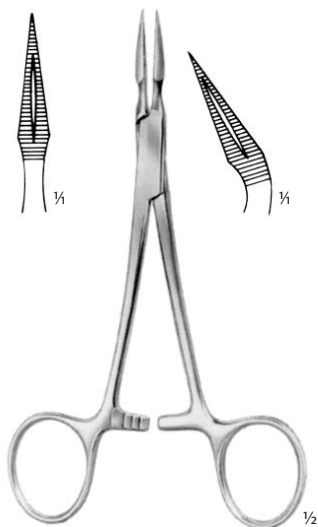

**STIEGLITZ**  
**114 91 0318** 13,5 cm **114 91 0319**

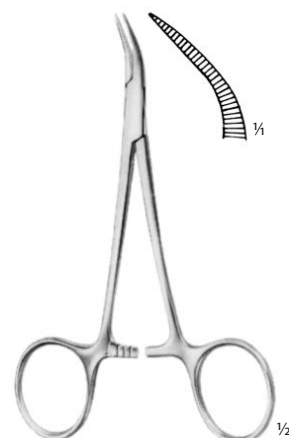

**PEET**  
**114 91 0323**  
11,5 cm

PINZETY TECHNICKÉ  
TECHNICAL FORCEPS

**114 08 1020**  
13,5 cm



**114 08 1030**  
19,0 cm



**114 08 1040**  
24,0 cm

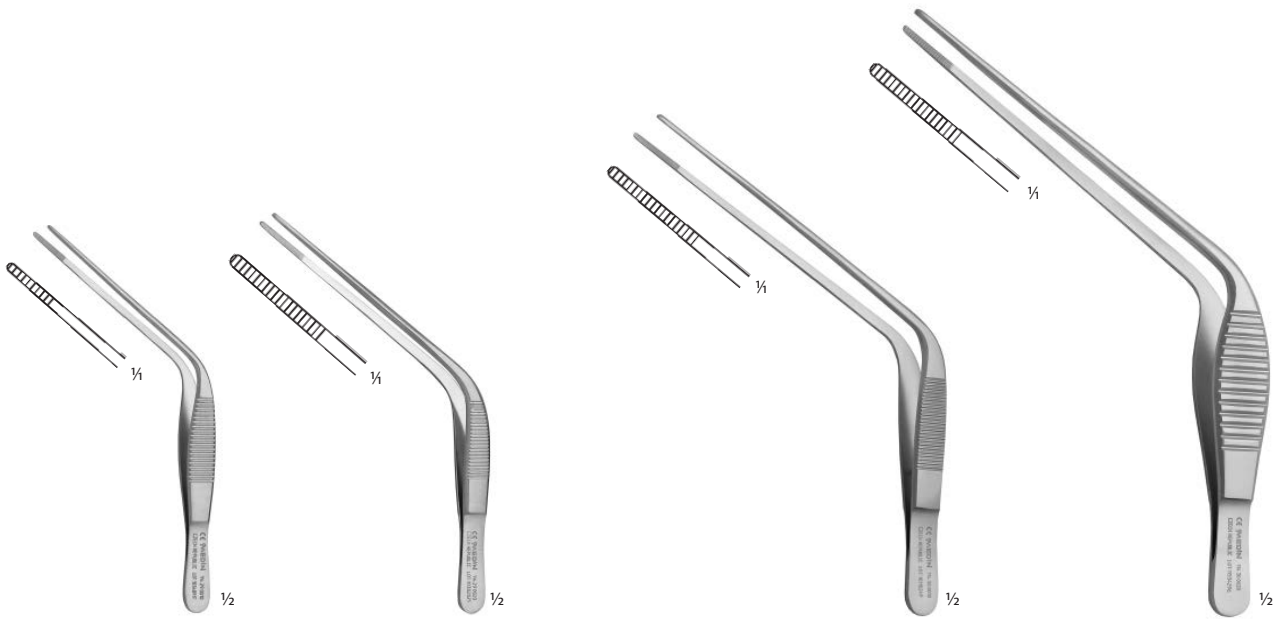

**TROELTSCH**  
**114 29 0010**  
11,0 cm

**TROELTSCH**  
**114 29 0020**  
11,0 cm

**TROELTSCH**  
**114 30 0010**  
15,0 cm

**TROELTSCH**  
**114 30 0020**  
18,0 cm

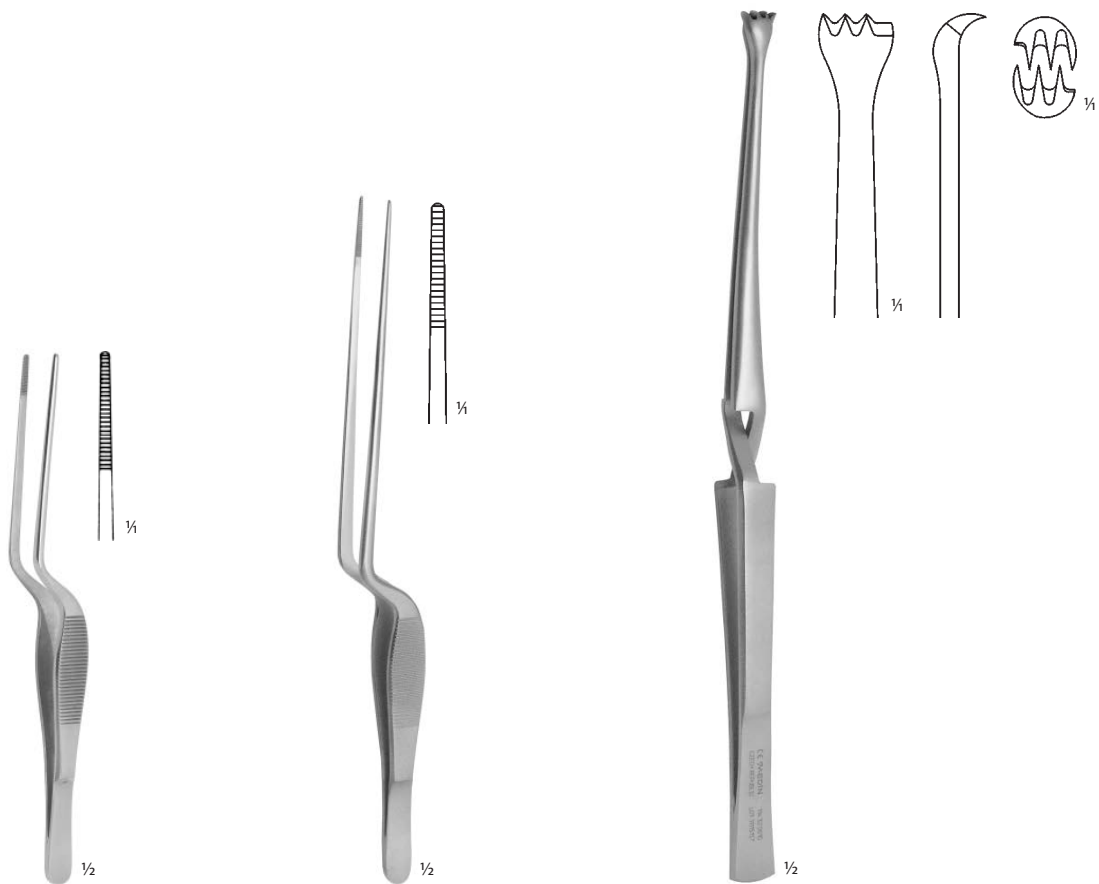

**LUCAE**  
**114 29 0030**  
14,5 cm

**114 30 0040**  
18,0 cm

**MARŠÍK**  
**114 32 0010**  
22,8 cm



**GRAEFE**  
10,5 cm



1,0 mm

**114 38 0010**

**114 38 0030**  
nemagnetická  
non magnetic



0,8 mm

**114 38 0020**

jemná  
fine  
**114 38 0040**  
jemná, nemagnetická  
fine, non magnetic



1,0 mm

**114 38 0150**

**114 38 0170**  
nemagnetická  
non magnetic



0,8 mm

**114 38 0160**

jemná  
fine



0,8 mm

**114 38 0100**

jemná  
fine

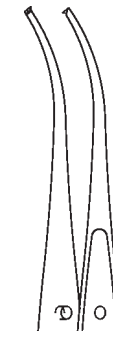

0,8 mm

**114 38 0200**

jemná  
fine



**GRAEFE**  
10,0 cm

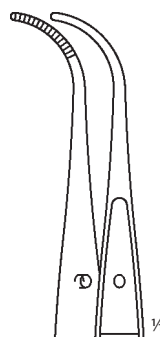

1,0 mm

**114 38 0110**

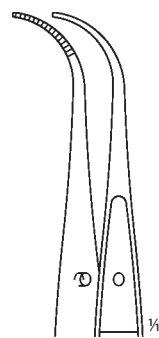

1,0 mm

**114 38 0120**  
nemagnetická  
non magnetic

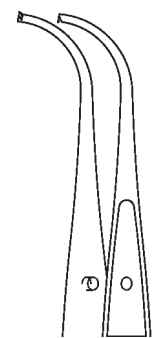

1,0 mm

**114 38 0210**  
nemagnetická  
non magnetic



1,2 mm

**114 91 0366**

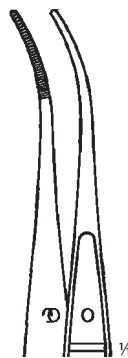

1,2 mm

**114 91 0368**



1,2 mm

**114 91 0372**

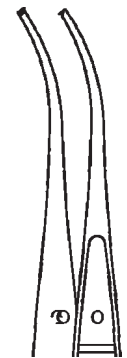

1,2 mm

**114 91 0374**



**GRAEFE**  
10,0 cm



**GRAEFE**  
**114 38 0350**  
11,0 cm



**GRAEFE**  
**114 38 0360**  
11,0 cm



**ELSCHMIG**  
**114 38 0370**  
10,5 cm



Pinzeta enukleační  
Enucleation forceps  
**114 38 0750**  
14,0 cm



Pinzeta na duhovku  
Iris forceps  
**114 38 0250**  
anatomická  
tissue  
5,0 cm

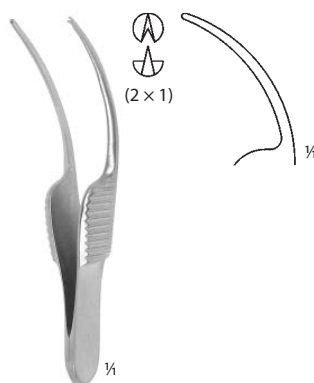

Pinzeta na duhovku  
Iris forceps  
**114 38 0270**  
chirurgická  
dressing  
5,0 cm

PINZETY NA DUHOVKU, PINZETY OČNÍ

IRIS FORCEPS, EYE FORCEPS



**KOUTNÝ**  
**114 38 0230**  
10,0 cm



**KUHNT**  
**114 38 0590**  
10,0 cm



**114 38 0830**  
pravá  
right

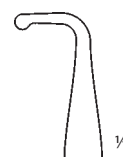
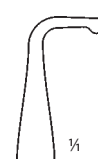

**114 38 0840**  
levá  
left



**DESMARRES**

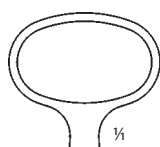

**114 38 0910**  
Fig. 1  
8,8 cm

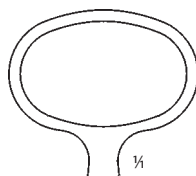

**114 38 0920**  
Fig. 2  
9,2 cm

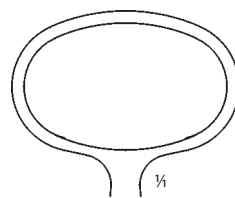

**114 38 0930**  
Fig. 3  
9,5 cm



**LAMBERT**  
**114 38 0960**  
9,0 cm



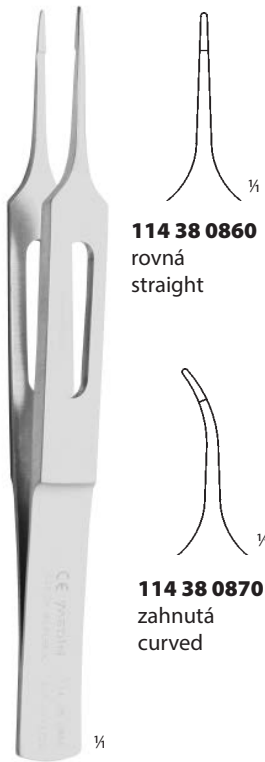

**114 38 0860**  
rovná  
straight

**114 38 0870**  
zahnutá  
curved

 Pinzeta na rohovku  
Corneal suturing forceps  
10,0 cm

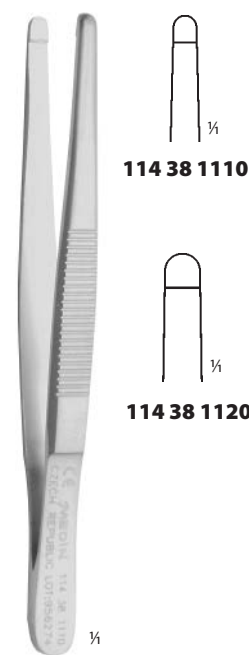
**CASTROVIEJO**  
**114 38 0850**  
10,0 cm

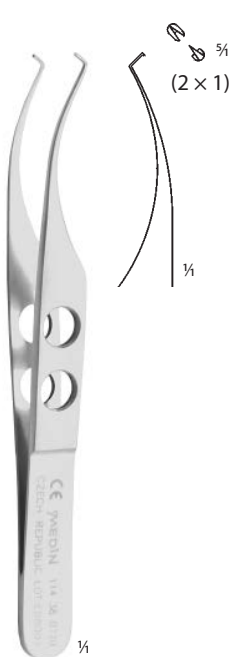
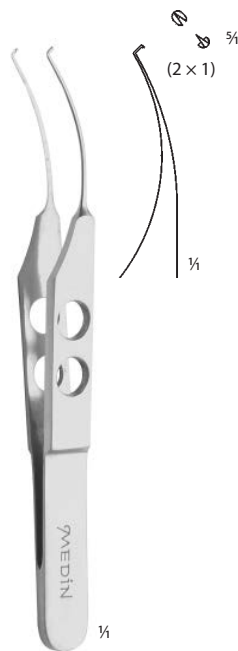
 Pinzeta na keratoplastiku  
Keratoplastic forceps  
**114 38 1230**  
8,5 cm

**114 38 1110**
**114 38 1120**
**BEER**  
8,5 cm

 Pinzeta na řasy  
Cilia forceps  
**114 38 1170**  
8,5 cm

**KOLIBRI**  
**114 38 0720**  
8,0 cm

**KOLIBRI**  
**114 38 1300**  
8,0 cm

 Pinzeta šicí  
Suturing forceps  
**114 38 1310**  
hladká  
smooth  
8,5 cm

 Pinzeta šicí  
Suturing forceps  
**114 38 1320**  
háčková  
hooked  
8,5 cm

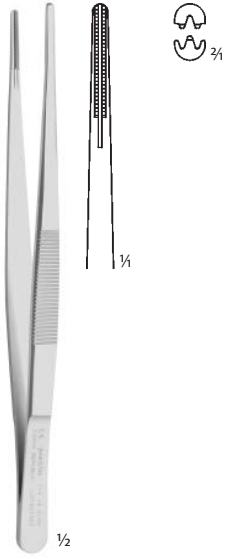
 Pinzeta šicí  
Suturing forceps  
**114 38 1330**  
8,0 cm

**PINZETY ATRAUMATICKÉ**  
NON-TRAUMATIC VASCULAR TISSUE FORCEPS



**114 14 0100**  
14,5 cm



**114 14 0110**  
20,0 cm

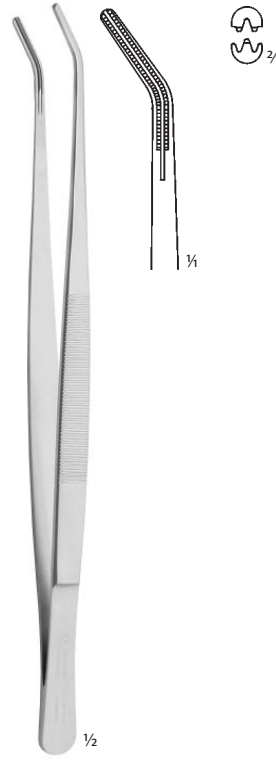

**114 14 0120**  
20,0 cm

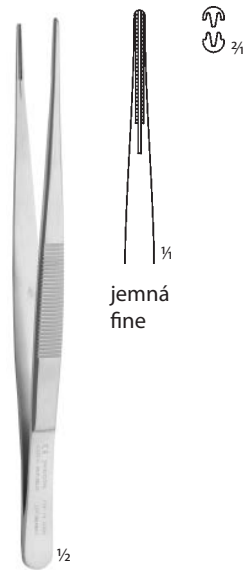

**114 14 0300**  
14,5 cm

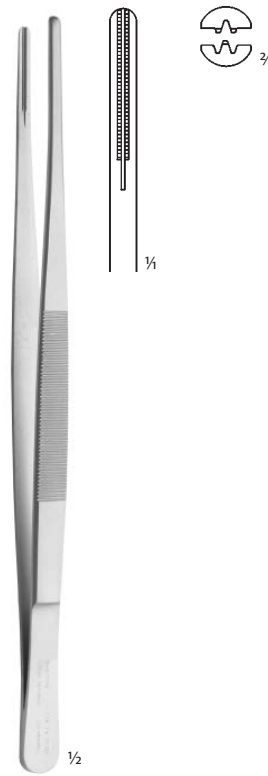

**114 14 0130**  
20,0 cm



**114 14 0140**  
24,8 cm

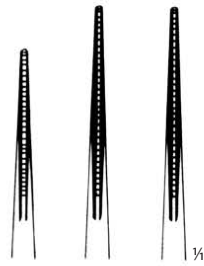

1,5 mm

- 114 91 0451** 16,0 cm
- 114 91 0453** 20,0 cm
- 114 91 0454** 24,0 cm

Original 20,0 cm

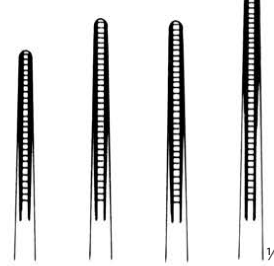
 $\frac{1}{2}$ 
**DE BAKEY**

2,0 mm

- 114 91 0455** 16,0 cm
- 114 91 0457** 20,0 cm
- 114 91 0458** 24,0 cm
- 114 91 0459** 30,0 cm

Original 20,0 cm

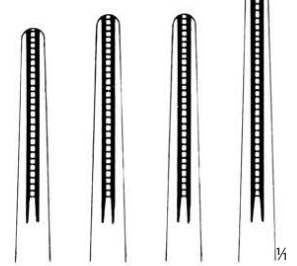
 $\frac{1}{2}$ 
**DE BAKEY**

2,8 mm

- 114 91 0460** 16,0 cm
- 114 91 0461** 20,0 cm
- 114 91 0462** 24,0 cm
- 114 91 0463** 30,0 cm

Original 20,0 cm

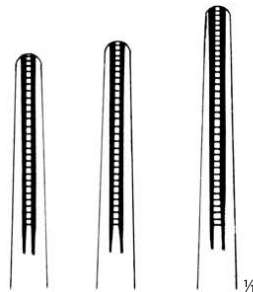
 $\frac{1}{2}$ 
**DE BAKEY**

3,5 mm

- 114 91 0468** 15,0 cm
- 114 91 0464** 20,0 cm
- 114 91 0465** 24,0 cm
- 114 91 0466** 30,0 cm

Original 20,0 cm

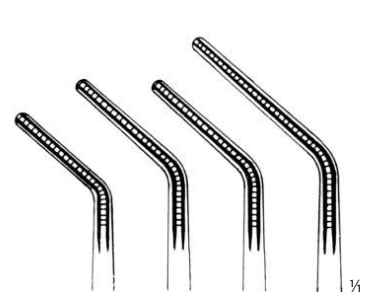
 $\frac{1}{2}$ 
**DE BAKEY**

2,0 mm

- 114 91 0467** 16,0 cm
- 114 91 0469** 20,0 cm
- 114 91 0470** 24,0 cm
- 114 91 0471** 30,0 cm

Original 20,0 cm

 $\frac{1}{2}$ 
**DE BAKEY**

PINZETY TVRDOKOVOVÉ  
FORCEPS WITH TUNGSTEN CARBIDE INSERT



Original 18,0 cm



**114 91 0472**  
15,0 cm



**114 91 0473**  
18,0 cm



**114 91 0474**  
20,0 cm



Original 18,0 cm

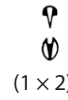

**114 91 0477**  
14,0 cm



**114 91 0478**  
16,0 cm



**114 91 0479**  
18,0 cm



**114 91 0475**  
23,0 cm



**114 91 0476**  
25,0 cm



**114 91 0480**  
20,0 cm



**114 91 0481**  
25,0 cm



**114 91 0482**  
30,0 cm

OEHLER



Original 12,5 cm



**SEMKEN**  
**114 91 0483** 12,5 cm  
**114 91 0484** 15,5 cm



**GILLIES**  
**114 91 0485**  
15,0 cm



**JEWELER**  
**114 91 0486**  
15,0 cm

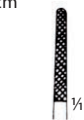
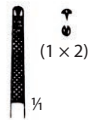
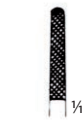
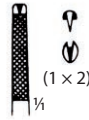

Original 12,0 cm

**114 91 0487**  
12,0 cm

**114 91 0490**  
12,0 cm

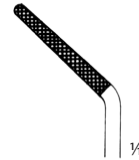
**114 91 0489**  
15,0 cm

**114 91 0491**  
15,0 cm

**ADSON**

**114 91 0492**

**114 91 0493**
**CUSHING**

 s preparačním koncem  
with dissector end  
17,5 cm

**CUSHING-TAYLOR**
**114 91 0494**

 s preparačním koncem  
with dissector end  
18,0 cm

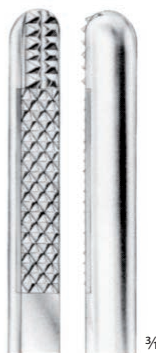
Original 24,0 cm

**DE BAKEY**

1,5 cm

**114 91 0495** 16,0 cm

**114 91 0496** 20,0 cm

**114 91 0497** 24,0 cm

2,0 cm

**114 91 0498** 16,0 cm

**114 91 0499** 20,0 cm

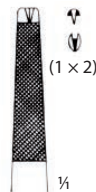
**114 91 0500** 24,0 cm

**114 91 0502**  
15,0 cm

**114 91 0503**  
23,0 cm

**BONNEY**  
**114 91 0501**  
18,0 cm

**WANGENSTEEN**



# 115

## SVORKY CLAMPS, FORCEPS

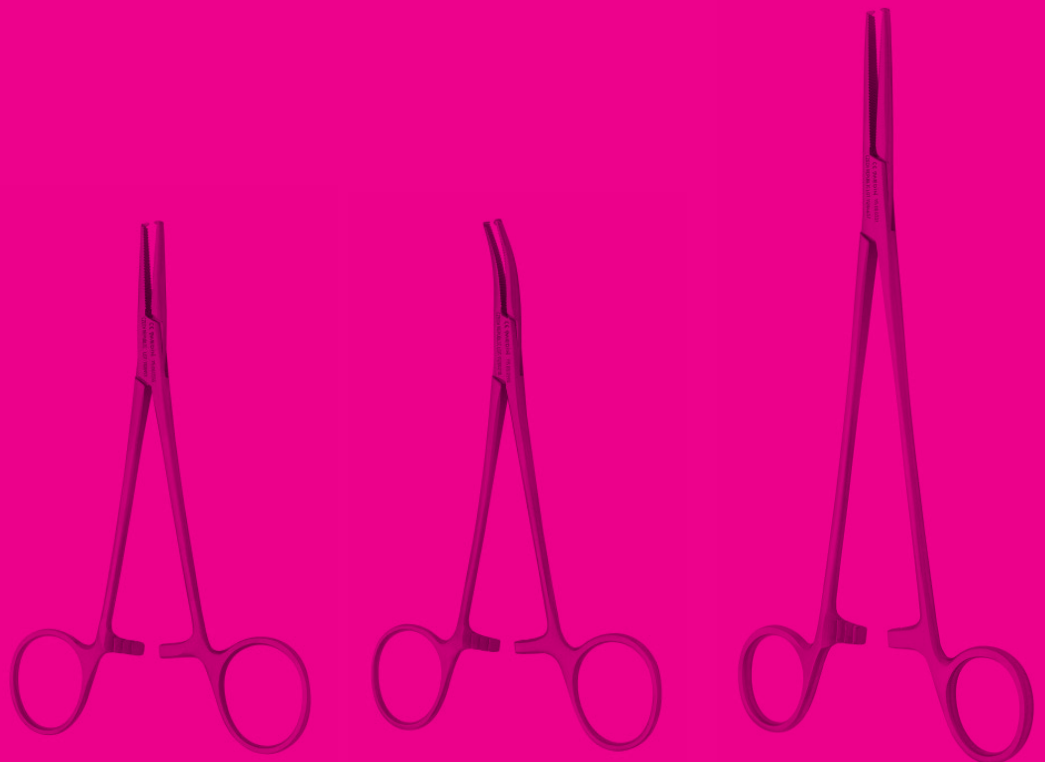





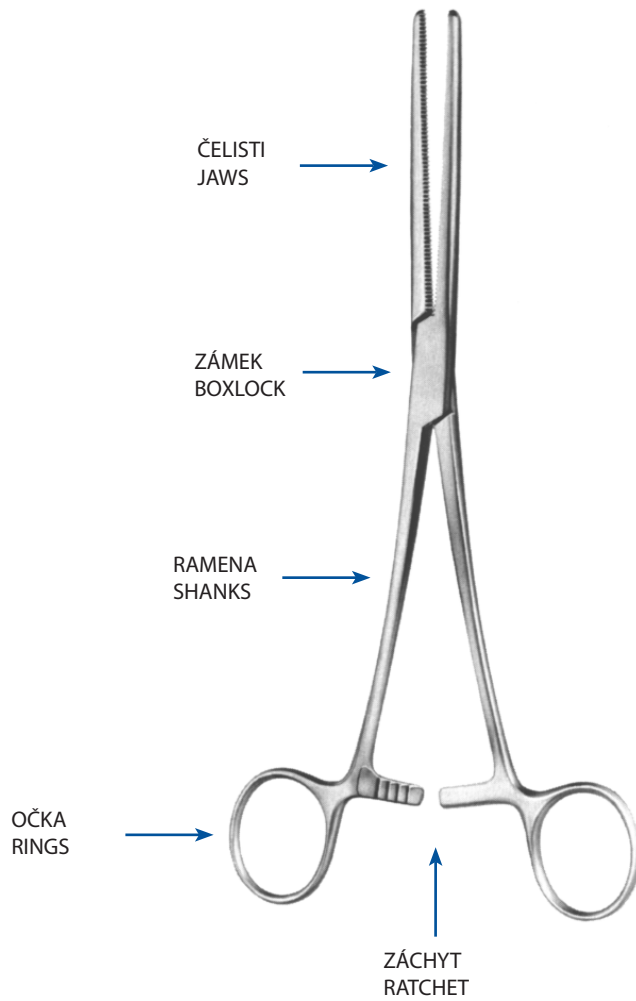

ŠPIČKA  
TIPS



BEZ ZUBŮ  
WITHOUT TEETH



(1 × 2)

SE ZUBY 1 × 2  
WITH TEETH 1 × 2

ZAKŘIVENÍ ČELISTI  
JAW CURVATURE

VROUBKOVÁNÍ  
SERRATIONS

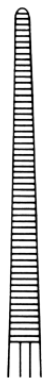

ROVNÁ  
STRAIGHT



ZAHNUTÁ  
CURVED



HORIZONTÁLNÍ  
HORIZONTAL



PODÉLNÉ  
LONGITUDINAL



KŘÍŽENÉ  
CROSS



**MICRO-BULLDOG**  
**115 14 0010**  
2,6 cm



**MICRO-BULLDOG**  
**115 14 0020**  
2,4 cm

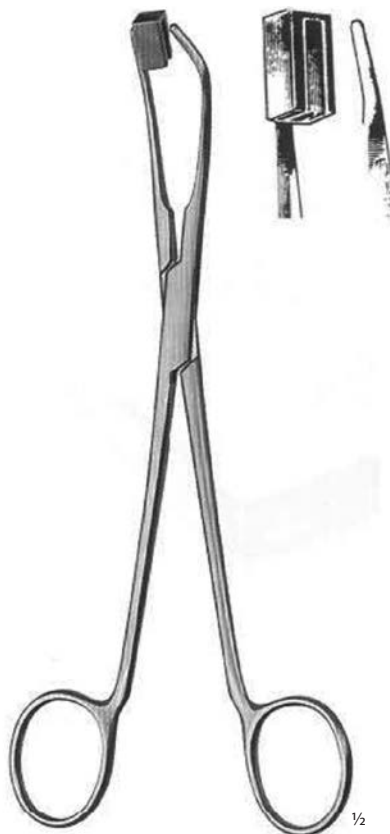

**SCHWARTZ**  
**117 50 0620**  
22,0 cm



**BABCOCK**

Original 18,0 cm



**115 91 0382**  
16,0 cm

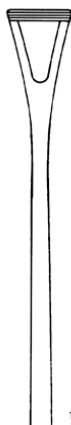

**115 91 0384**  
18,0 cm



**115 91 0385**  
20,0 cm



**115 91 0386**  
24,0 cm



**DIEFFENBACH**



**115 91 0031**  
3,5 cm



**115 91 0032**  
5,0 cm



**115 91 0034**  
3,5 cm

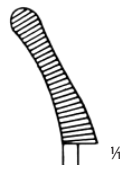

**115 91 0035**  
5,0 cm



**DIEFFENBACH**  
**115 14 0150**  
5,8 cm

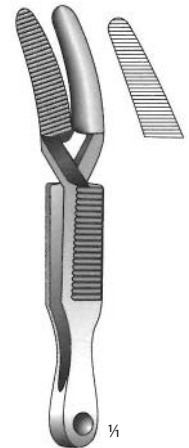

**DIEFFENBACH**  
**115 14 0160**  
5,8 cm



**JOHNS-HOPKINS**  
**115 91 0037**  
24,5 cm



Original 6,5 cm

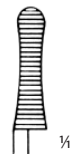

**115 91 0039**  
5,0 cm

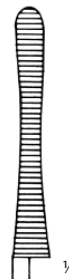

**115 91 0040**  
6,5 cm



**115 91 0041**  
7,5 cm

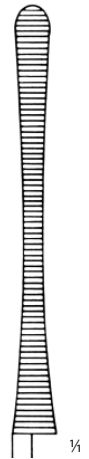

**115 91 0042**  
9,0 cm

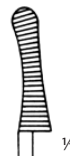

**115 91 0044**  
5,0 cm

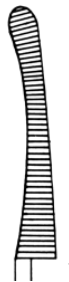

**115 91 0045**  
6,5 cm



**115 91 0046**  
7,5 cm

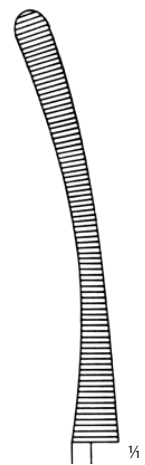

**115 91 0047**  
9,0 cm



**ALLIS**  
**115 91 0364**  
15,0 cm



**ALLIS**  
**115 91 0365** 15,0 cm  
**115 91 0366** 19,0 cm  
**115 91 0367** 25,0 cm

Original 15,0 cm



**CHAPUT**  
**115 91 0048**  
13,0 cm



**TUFFIER**  
**115 91 0049**  
13,0 cm

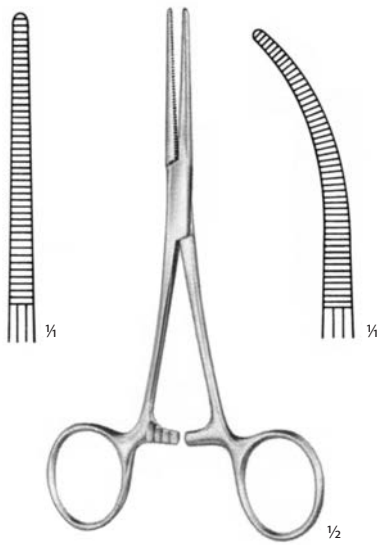

**PEAN-DELICATE**

<b>115 91 0149</b>	13,0 cm	<b>115 91 0152</b>
<b>115 91 0150</b>	14,0 cm	<b>115 91 0153</b>
<b>115 91 0151</b>	16,0 cm	<b>115 91 0154</b>

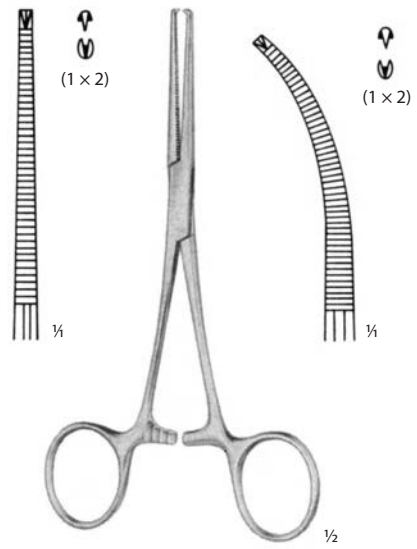

**KOCHER-DELICATE**

<b>115 91 0155</b>	13,0 cm	<b>115 91 0158</b>
<b>115 91 0156</b>	14,0 cm	<b>115 91 0159</b>
<b>115 91 0157</b>	16,0 cm	<b>115 91 0160</b>

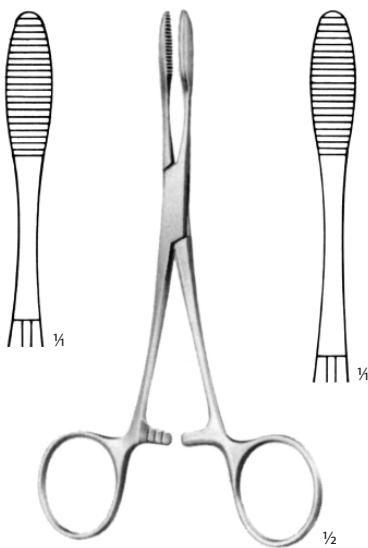

**PEAN**

<b>115 91 0052</b>	14,0 cm	<b>115 91 0053</b>
		16,0 cm

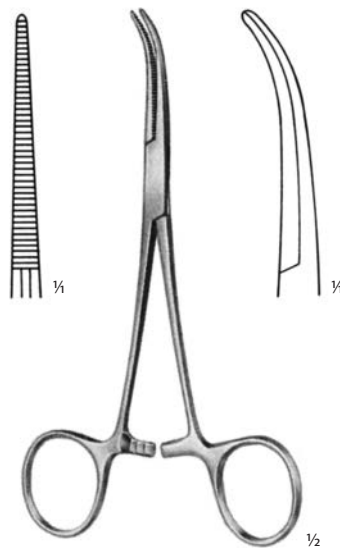

**DANDY**

<b>115 91 0190</b>	14,0 cm
--------------------	---------

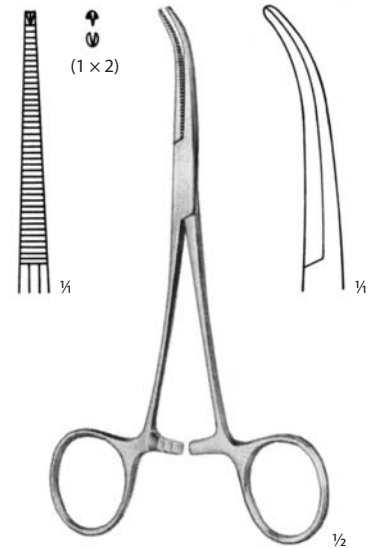

**DANDY**

<b>115 91 0191</b>	14,0 cm
--------------------	---------

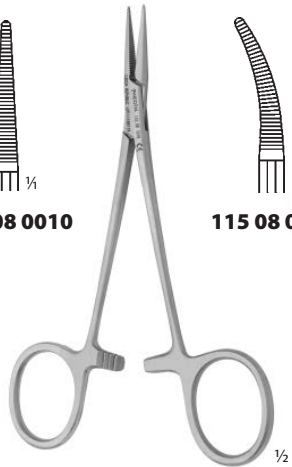
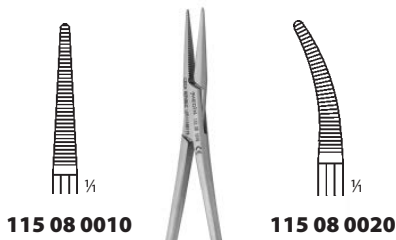

**MOSQUITO-HALSTED**  
standard  
standard  
12,0 cm

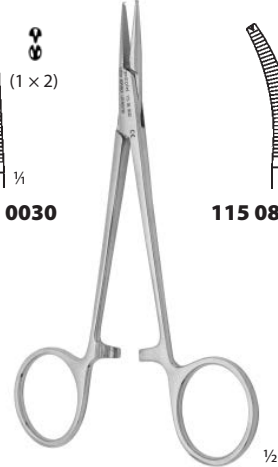

**MOSQUITO-HALSTED**  
standard  
standard  
12,0 cm

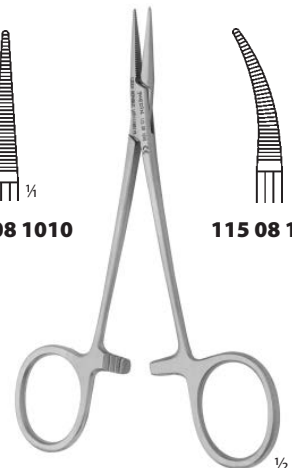
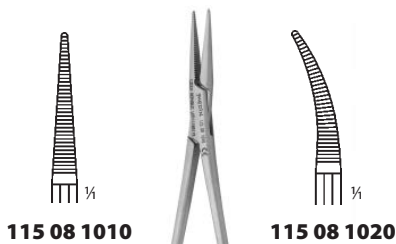

**MOSQUITO-HALSTED**  
jemné  
fine  
12,0 cm

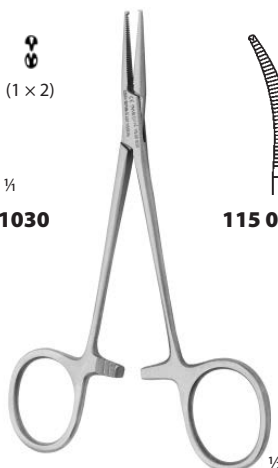

**MOSQUITO-HALSTED**  
jemné  
fine  
12,0 cm

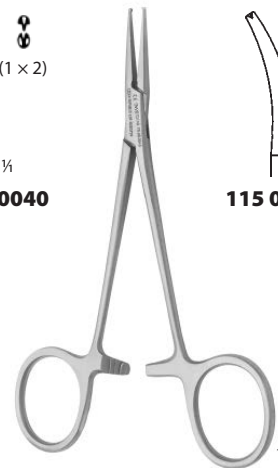

**MOSQUITO-HALSTED**  
hladká čelist  
smooth jaw  
12,0 cm

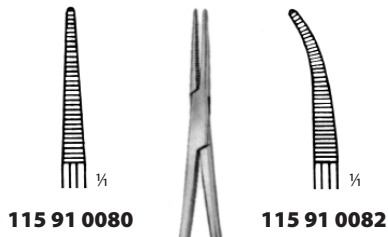

**HALSTEAD-MOSQUITO**  
12,5 cm

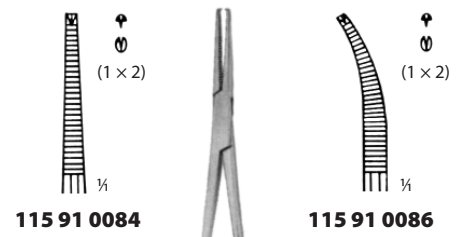

**HALSTEAD-MOSQUITO**  
12,5 cm

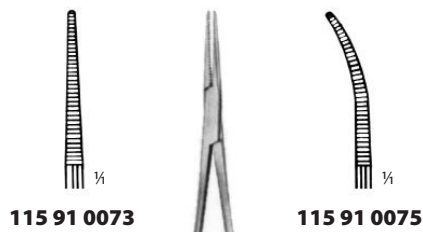

**MICRO-MOSQUITO**  
12,0 cm

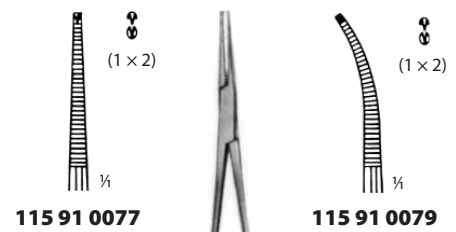

**MICRO-MOSQUITO**  
12,0 cm

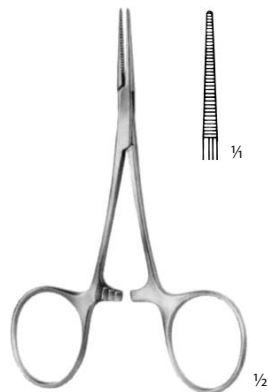

**HARTMANN**  
115 91 0068  
10,0 cm

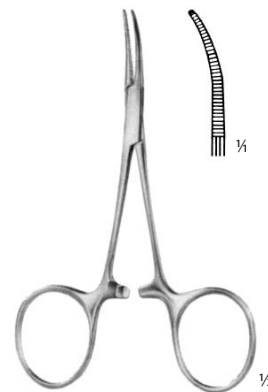

**HARTMANN**  
115 91 0069  
10,0 cm

SVORKY NA CÉVY  
ARTERY FORCEPS

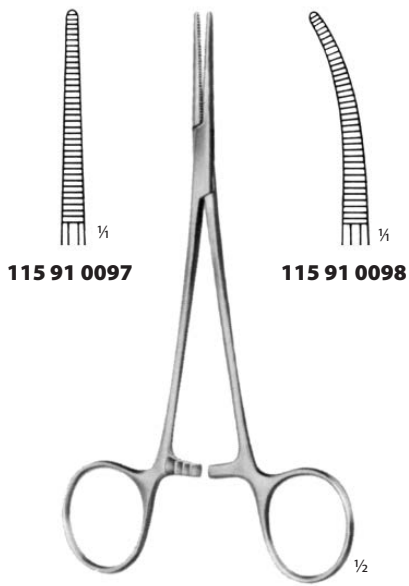

115 91 0097

115 91 0098

**LERICHE**  
15,0 cm

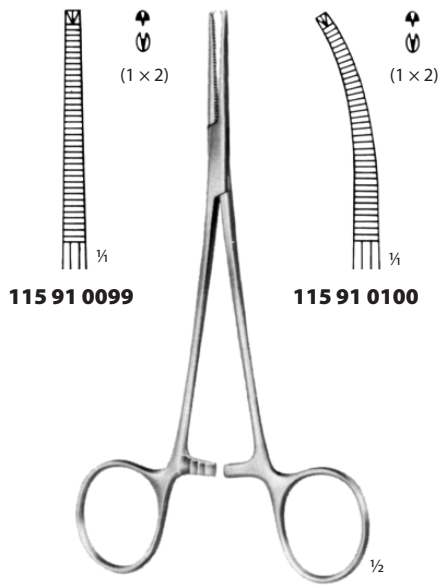

115 91 0099

115 91 0100

**LERICHE**  
15,0 cm

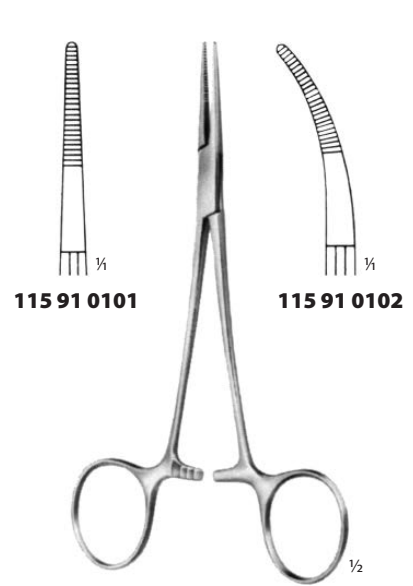

115 91 0101

115 91 0102

**PROVIDENCE-HOSPITAL**  
14,0 cm

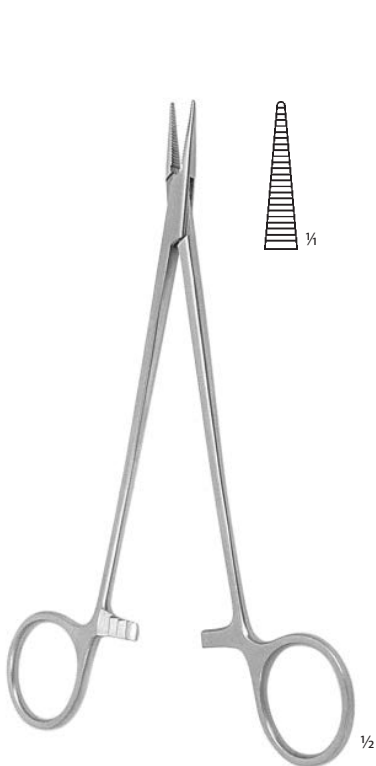

**PEAN**  
115 08 0071  
17,5 cm

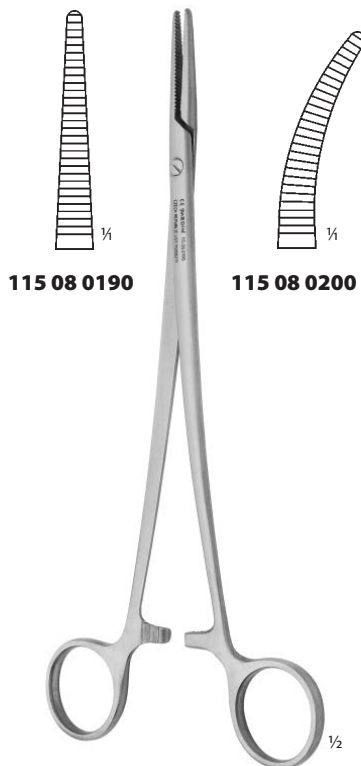

115 08 0190

115 08 0200

**PEAN**  
20,0 cm

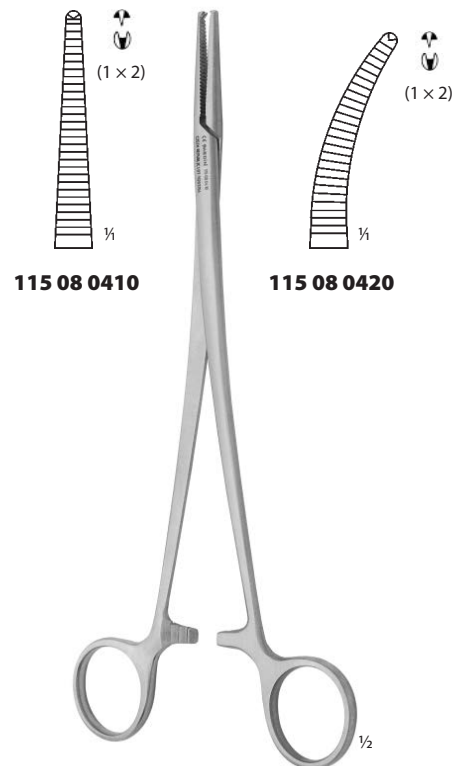

115 08 0410

115 08 0420

**KOCHER**  
jemná  
fine  
20,0 cm



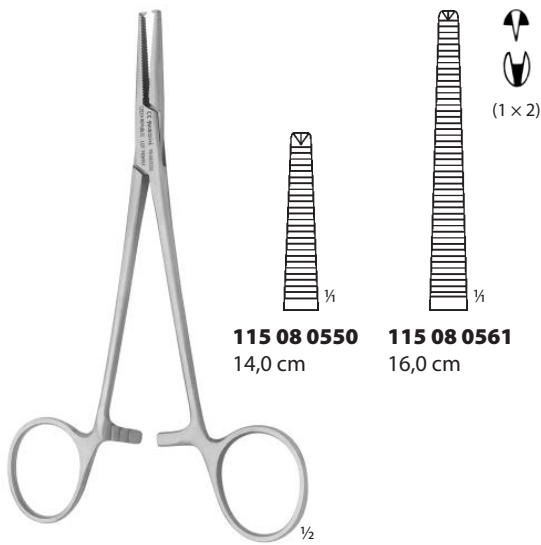

**115 08 0550**  
14,0 cm

**115 08 0561**  
16,0 cm

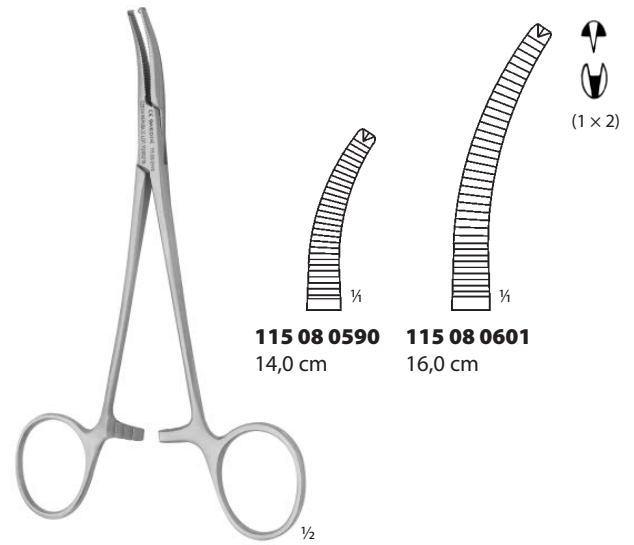

**115 08 0590**  
14,0 cm

**115 08 0601**  
16,0 cm

**ROCHESTER-OCHSNER**  
**115 08 0550**  
14,0 cm

**ROCHESTER-OCHSNER**  
**115 08 0590**  
14,0 cm

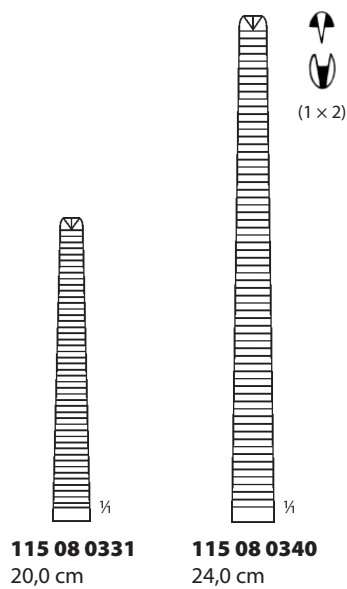

**115 08 0331**  
20,0 cm

**115 08 0340**  
24,0 cm



**KOCHER**  
**115 08 0331**  
20,0 cm

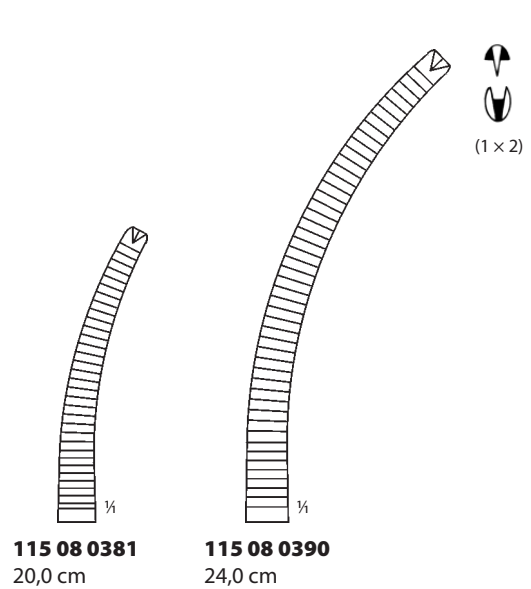

**115 08 0381**  
20,0 cm

**115 08 0390**  
24,0 cm

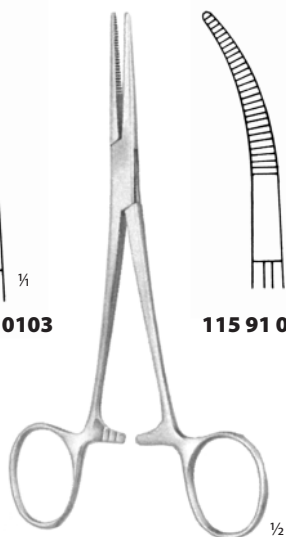
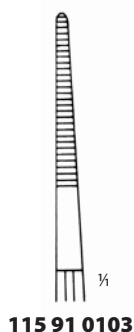

**KELLY**  
14,0 cm

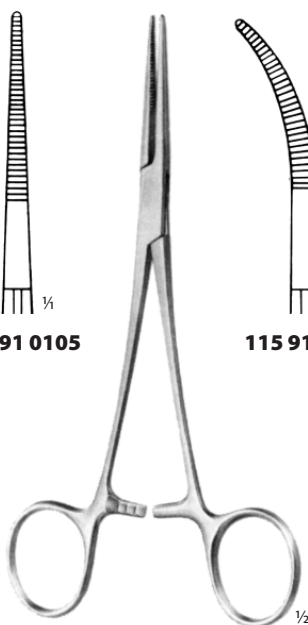
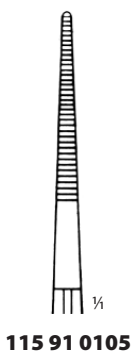
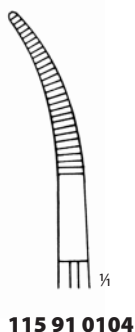

**KELLY-RANKIN**  
16,0 cm

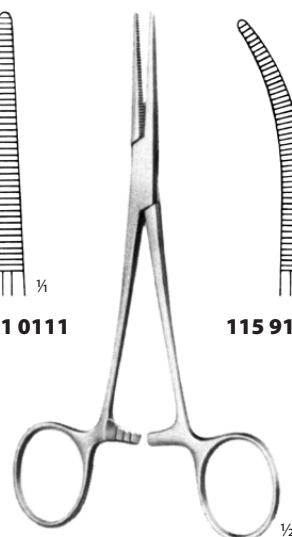
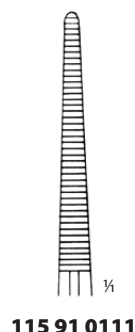
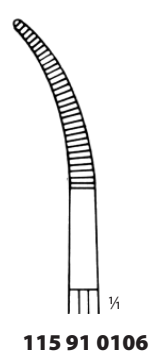

**CRILE**  
14,0 cm

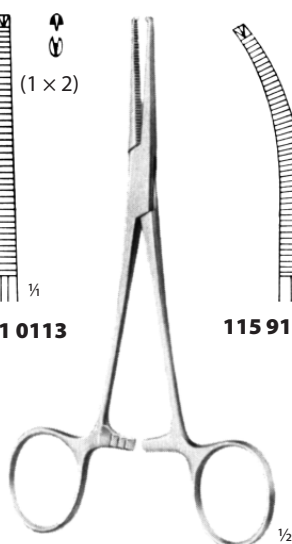
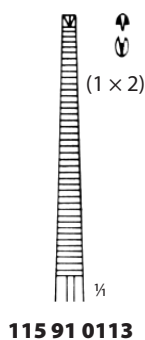
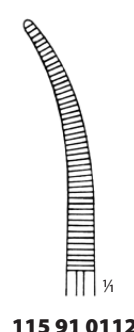

**CRILE**  
14,0 cm

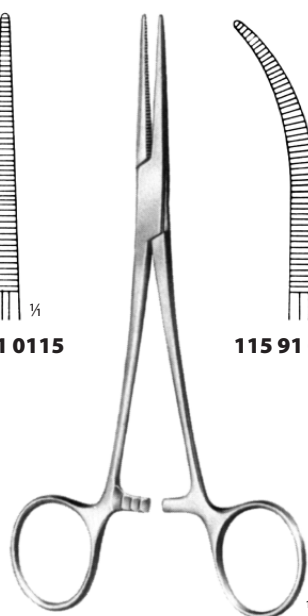
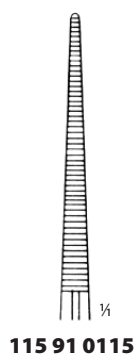
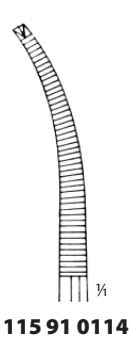

**CRILE-RANKIN**  
16,0 cm

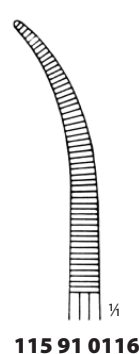

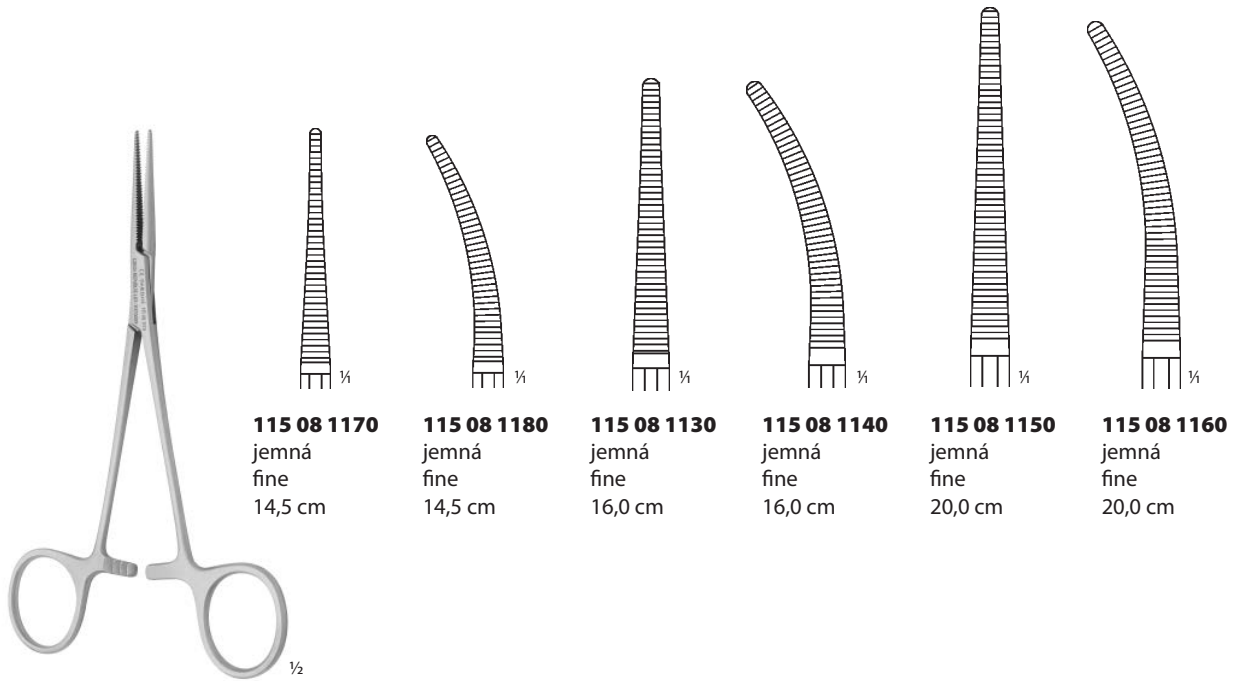

**115 08 1170**  
jemná  
fine  
14,5 cm

**115 08 1180**  
jemná  
fine  
14,5 cm

**115 08 1130**  
jemná  
fine  
16,0 cm

**115 08 1140**  
jemná  
fine  
16,0 cm

**115 08 1150**  
jemná  
fine  
20,0 cm

**115 08 1160**  
jemná  
fine  
20,0 cm

**PEAN**  
**115 08 1170**  
jemná  
fine  
14,5 cm

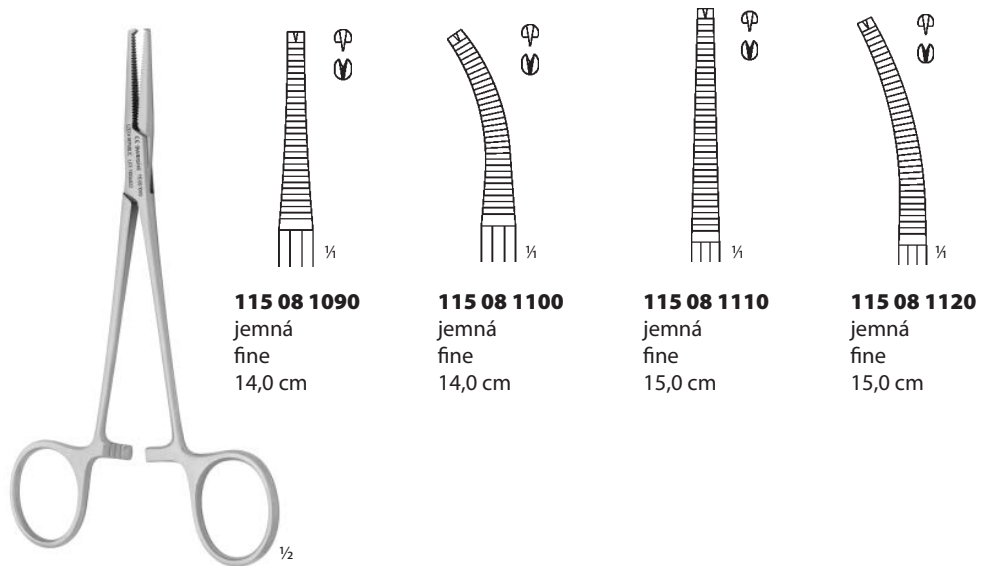

**115 08 1090**  
jemná  
fine  
14,0 cm

**115 08 1100**  
jemná  
fine  
14,0 cm

**115 08 1110**  
jemná  
fine  
15,0 cm

**115 08 1120**  
jemná  
fine  
15,0 cm

**KOCHER**  
**115 08 1090**  
jemná  
fine  
14,0 cm

SVORKY NA CÉVY  
ARTERY FORCEPS



ROCHESTER-PEAN

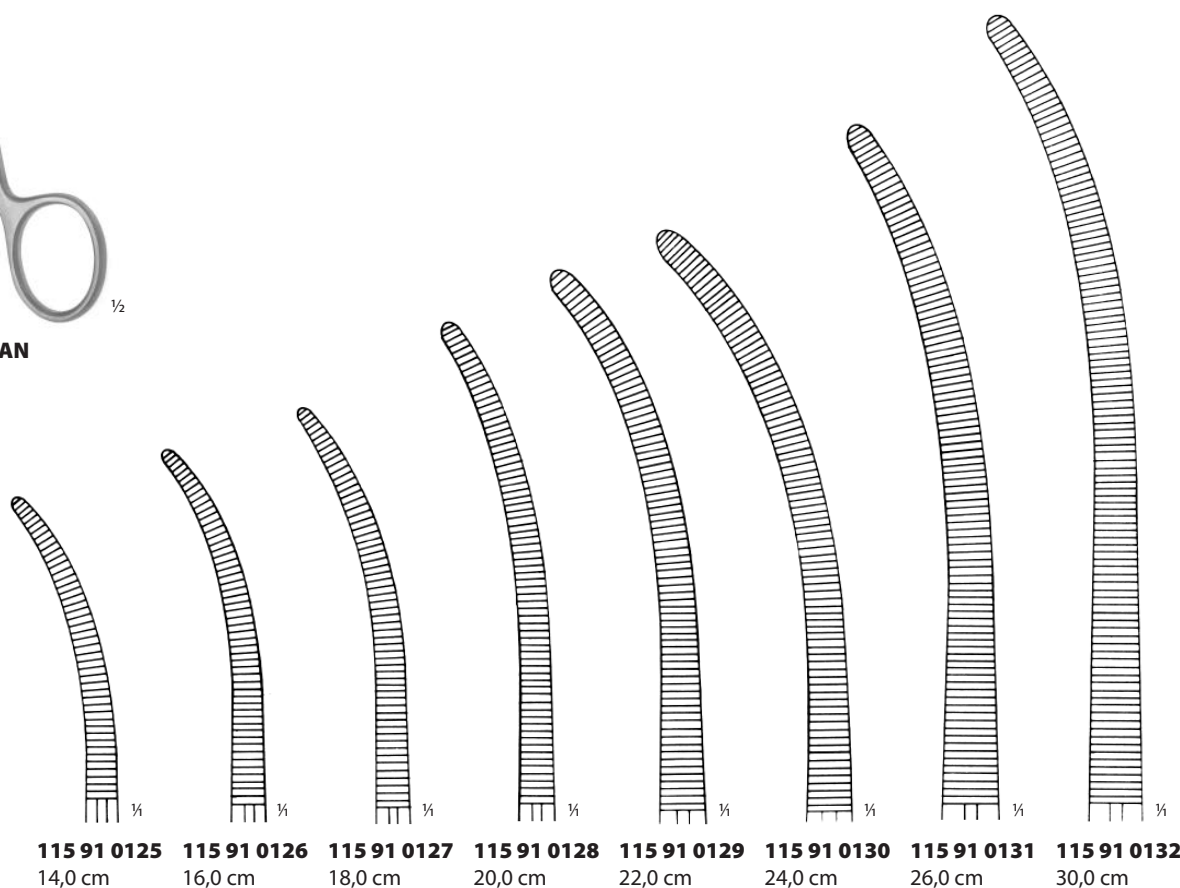
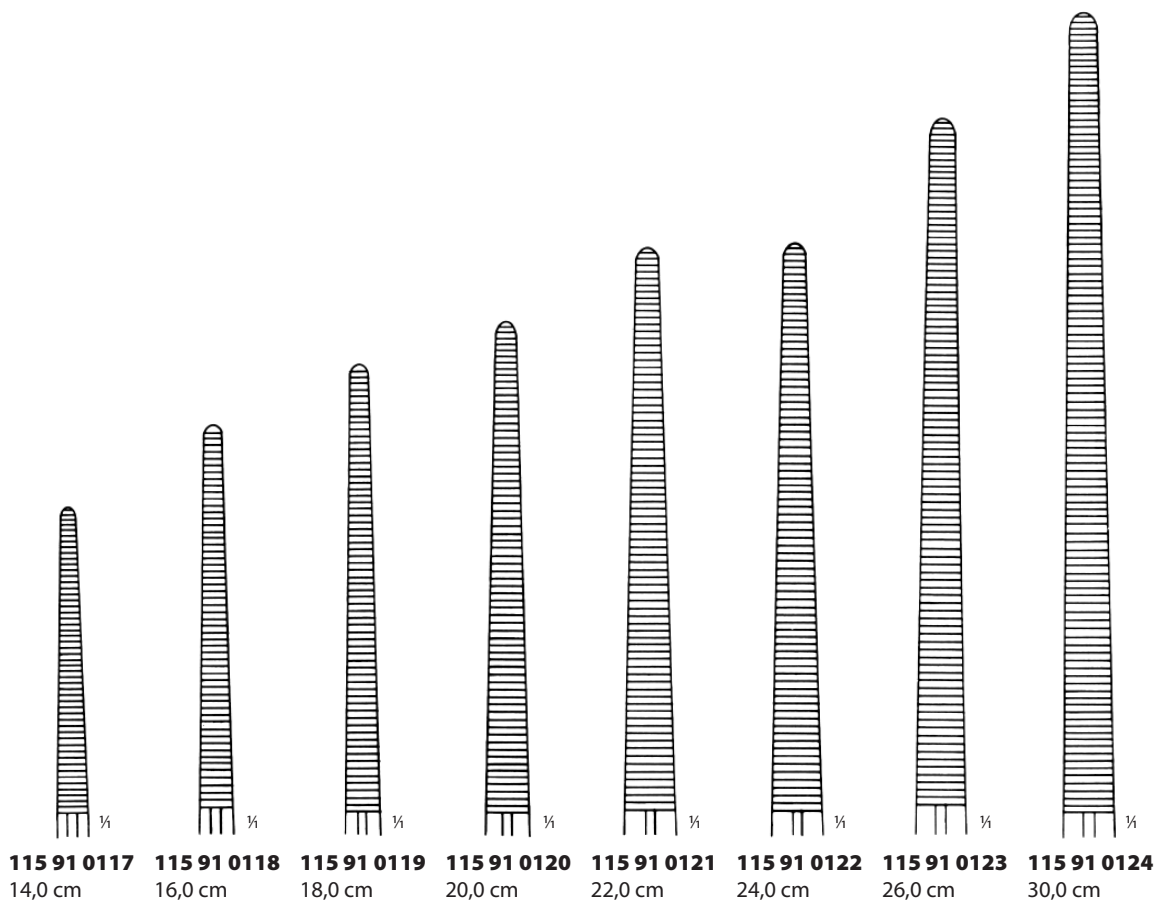



OCHSNER-KOCHER

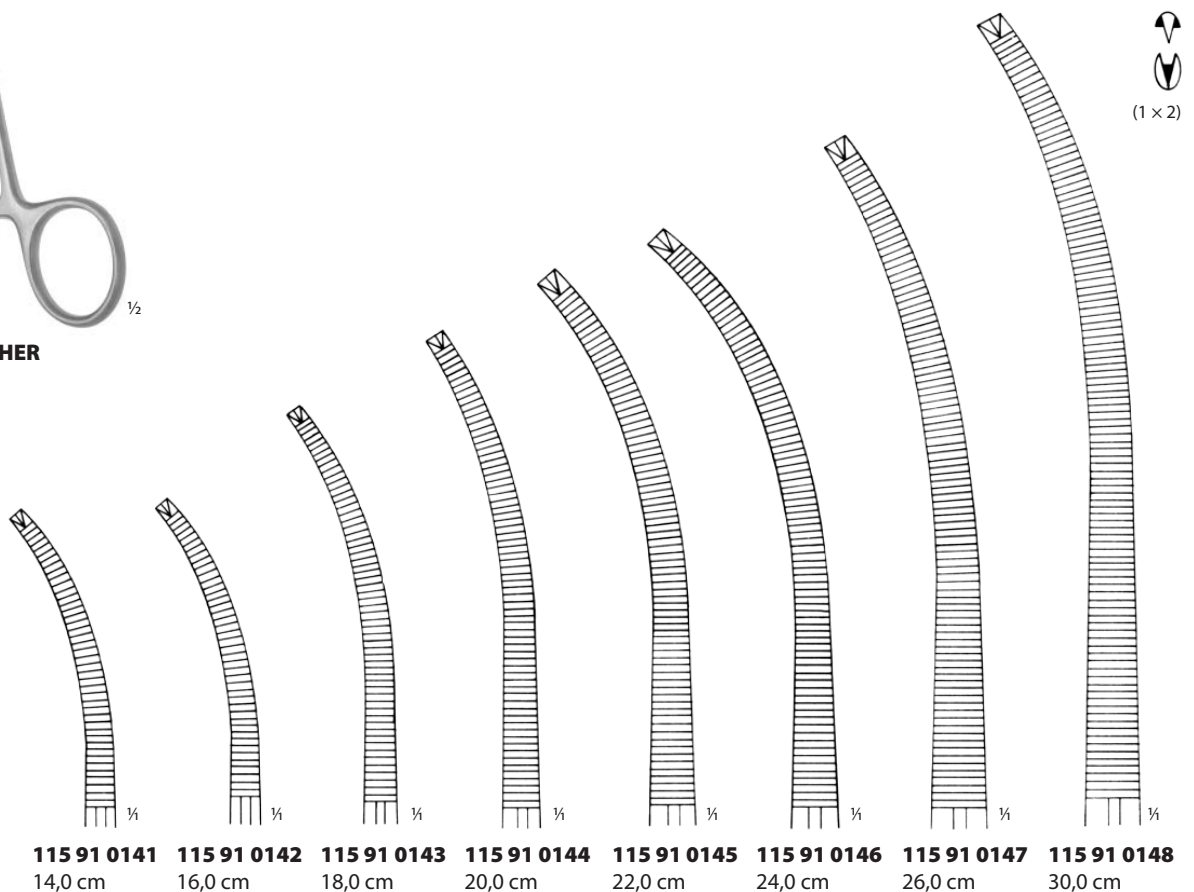
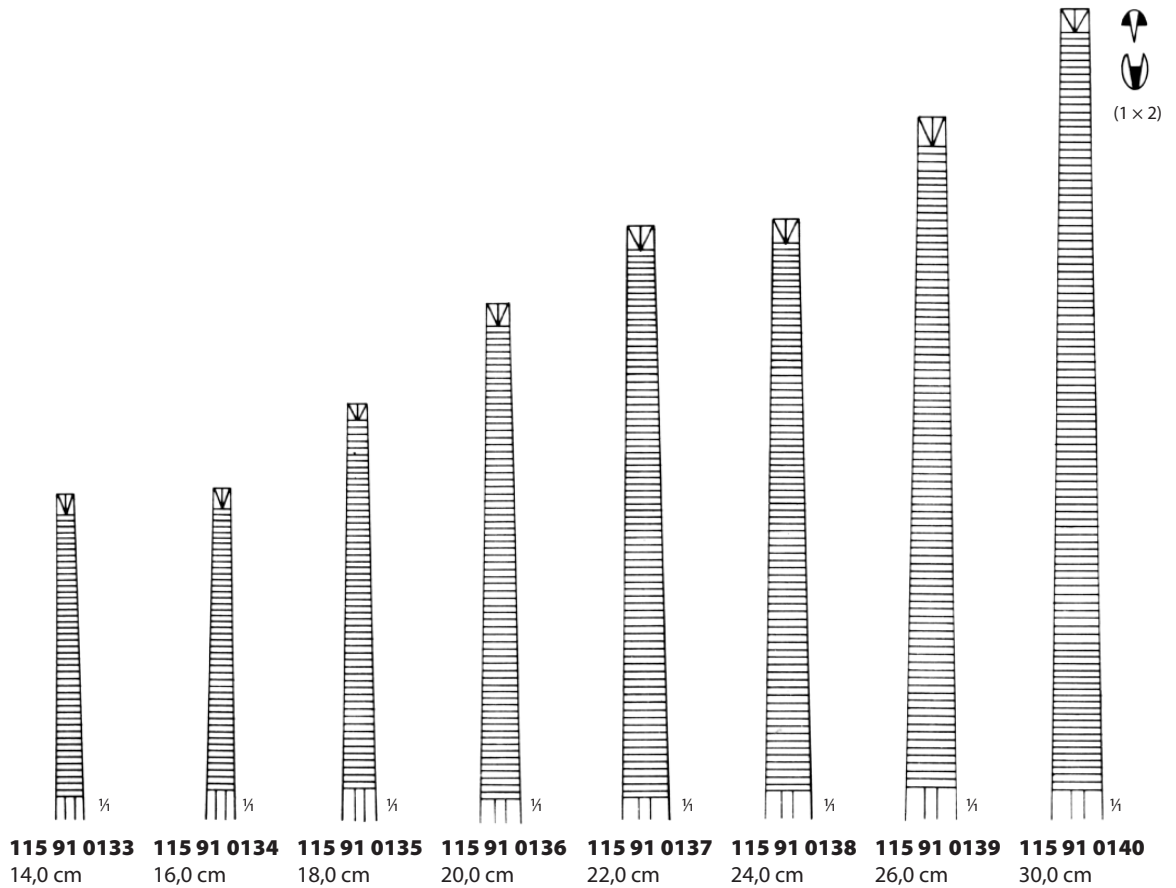

SVORKY NA CÉVY  
ARTERY FORCEPS



**OVERHOLT-GEISSENDOERFER**  
**115 91 0161**  
21,0 cm

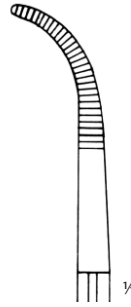

Fig. 1  
21,0 cm **115 91 0161**  
27,0 cm **115 91 0168**

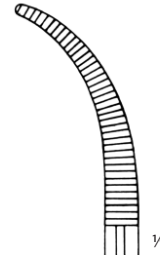

Fig. 2  
**115 91 0162**  
**115 91 0169**

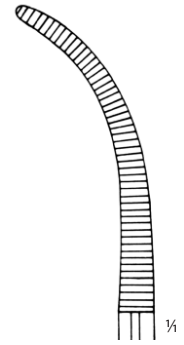

Fig. 3  
**115 91 0163**  
**115 91 0170**

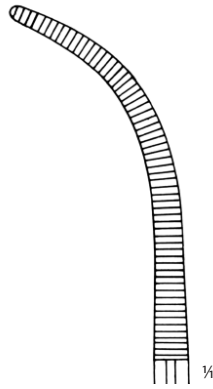

Fig. 4  
21,0 cm **115 91 0164**  
27,0 cm **115 91 0171**

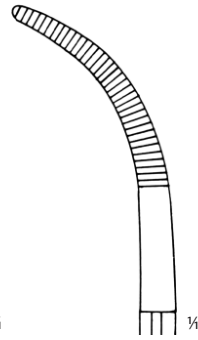

Fig. 5  
**115 91 0165**  
**115 91 0172**

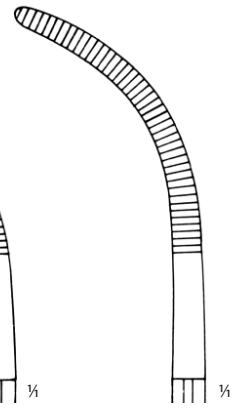

Fig. 6  
**115 91 0166**  
**115 91 0173**

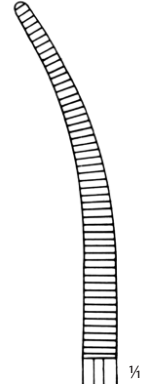
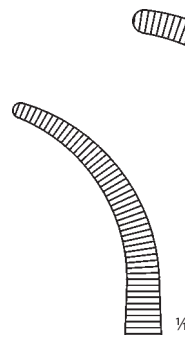

Fig. 7  
**115 91 0167**  
**115 91 0174**



**OVERHOLT**  
19,5 cm



**115 14 1150**  
19,5 cm  
Fig. 1

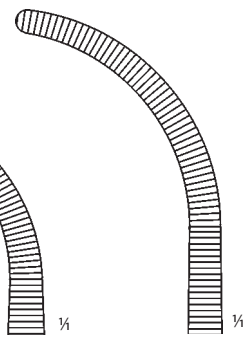

**115 14 1160**  
22,2 cm  
Fig. 2

Original 19,5 cm

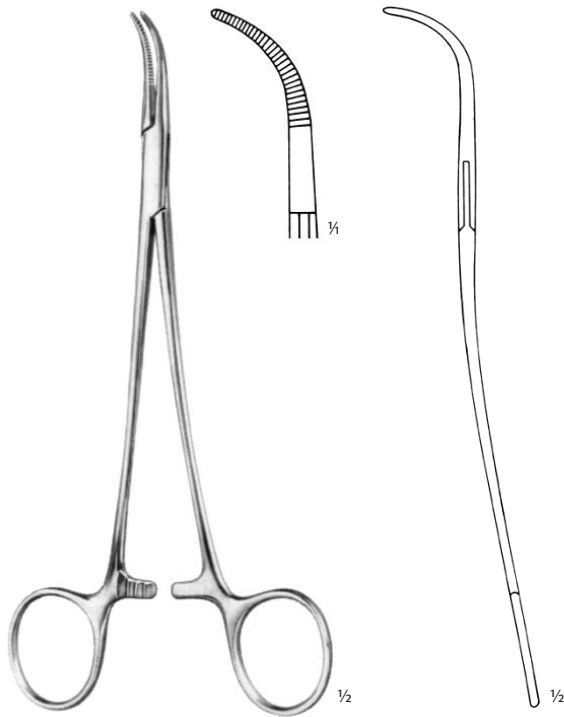

**OVERHOLT**  
**115 91 0176**  
18,5 cm

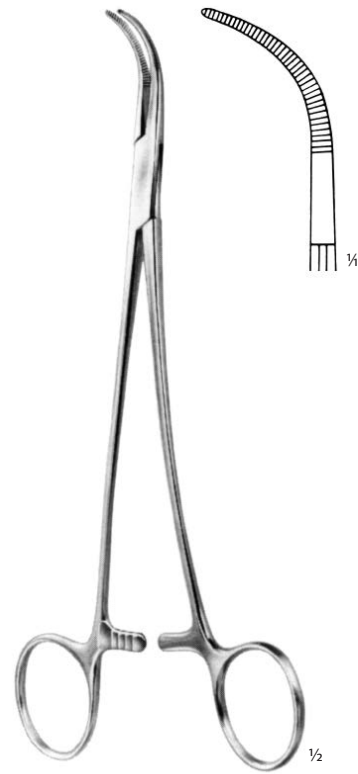

**OVERHOLT**  
**115 91 0177**  
20,5 cm

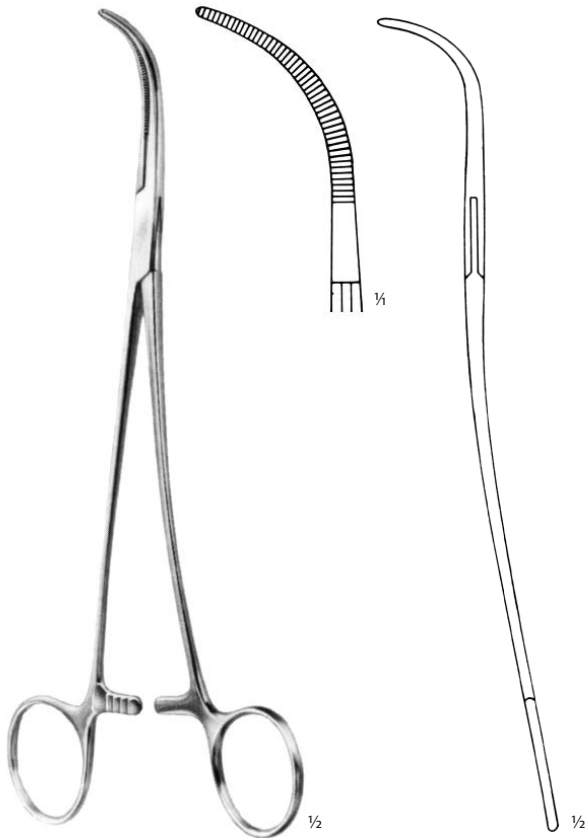

**OVERHOLT**  
**115 91 0178**  
21,0 cm

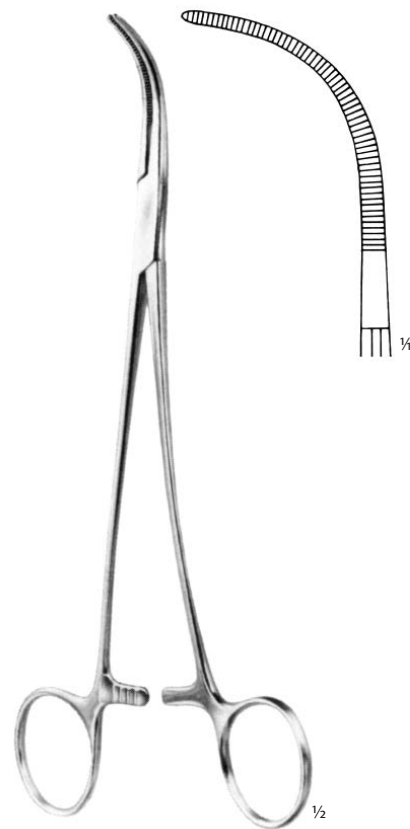

**OVERHOLT**  
**115 91 0179**  
21,5 cm



**BABY-ADSON**  
**115 91 0180**  
14,0 cm



**BABY-ADSON**  
**115 91 0181**  
18,0 cm

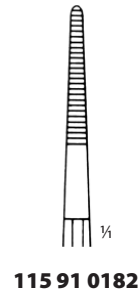

**115 91 0182**

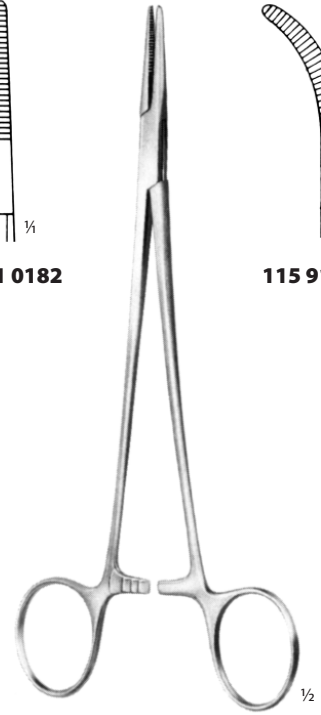

**115 91 0183**

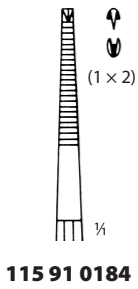

**115 91 0184**

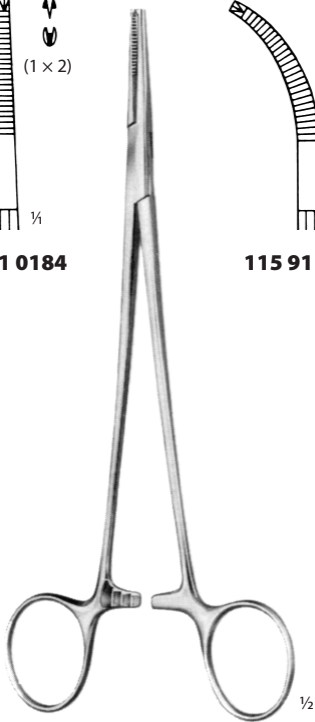

**ADSON**  
18,5 cm

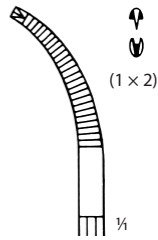

**115 91 0185**

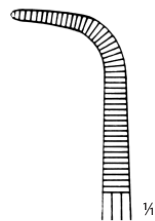

**115 91 0186**  
18,0 cm



**MEEKER**

**115 91 0187**  
28,0 cm

Original 18,0 cm



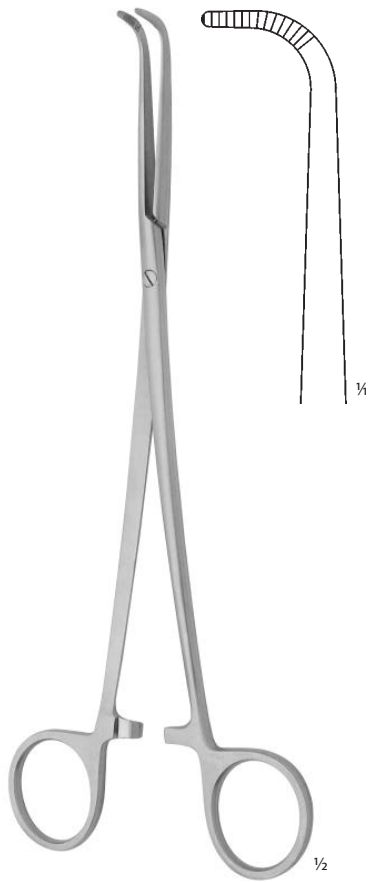

**KELLY**  
**115 08 0520**  
22,5 cm

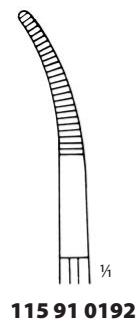

**115 91 0192**

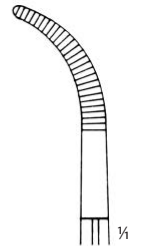
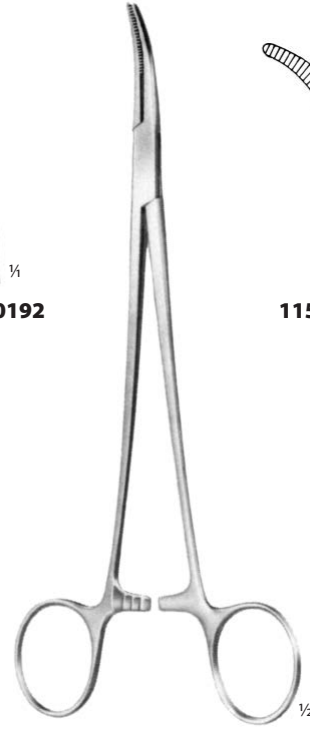

**115 91 0193**

**SCHNIDT-SAWTELL**  
19,0 cm

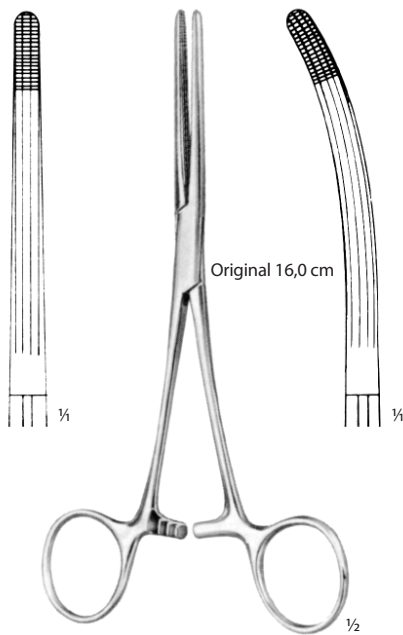

**ROCHESTER-CARMALT**  
**115 91 0196** 16,0 cm    **115 91 0198**  
**115 91 0197** 20,0 cm    **115 91 0199**

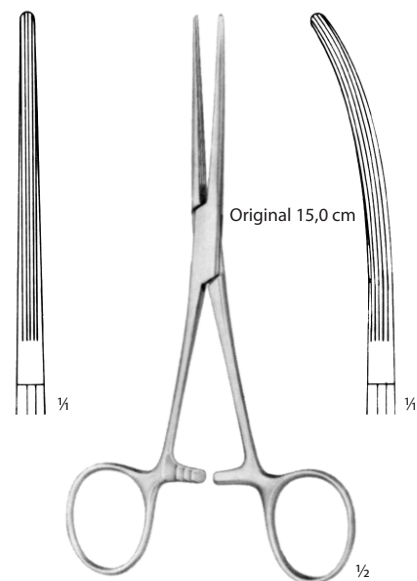

**BAINBRIDGE**  
**115 91 0200** 15,0 cm    **115 91 0202**  
**115 91 0201** 18,5 cm    **115 91 0203**

SVORKY NA CÉVY  
ARTERY FORCEPS

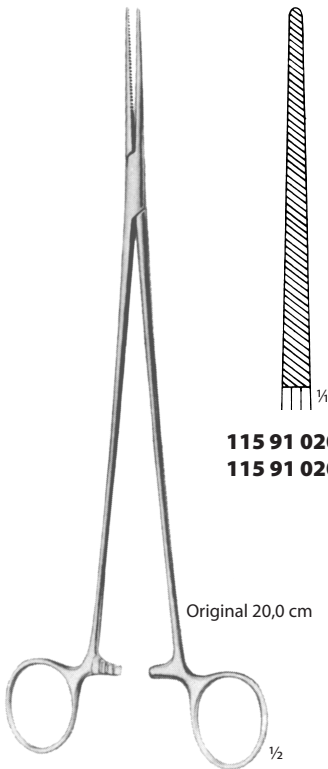

**115 91 0204**  
**115 91 0205**

20,0 cm  
26,0 cm

Original 20,0 cm

**BENGOLEA**

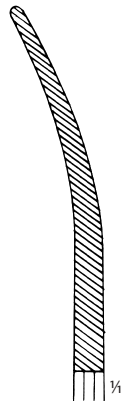

**115 91 0206**  
**115 91 0207**

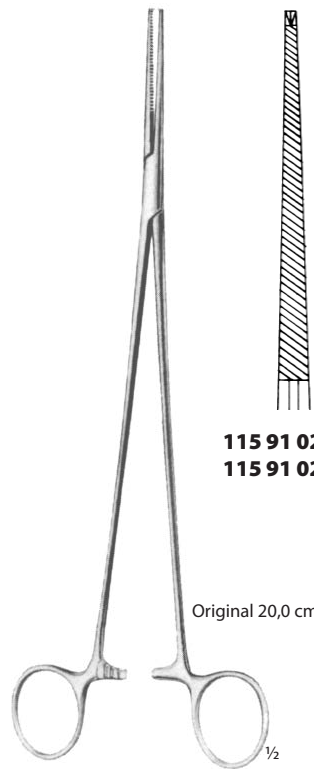

**115 91 0208**  
**115 91 0209**

20,0 cm  
26,0 cm

Original 20,0 cm

**BENGOLEA**

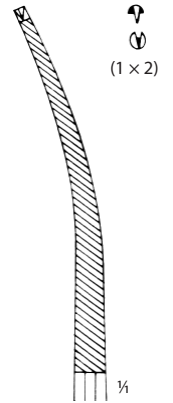

**115 91 0210**  
**115 91 0211**



Original 24,0 cm

**GRAFOORD-SELLORS**



**115 91 0212**  
22,0 cm

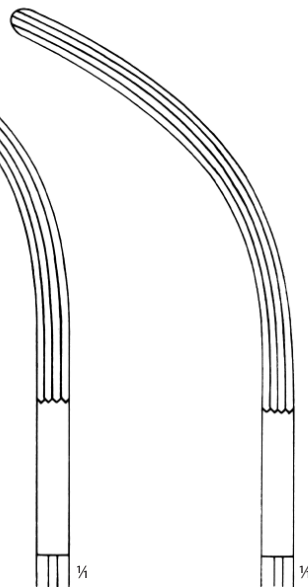

**115 91 0213**  
23,0 cm

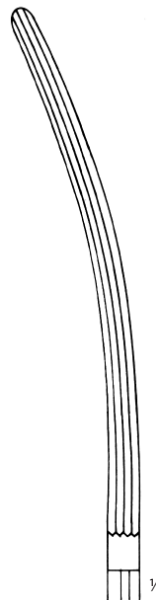

**115 91 0214**  
24,0 cm

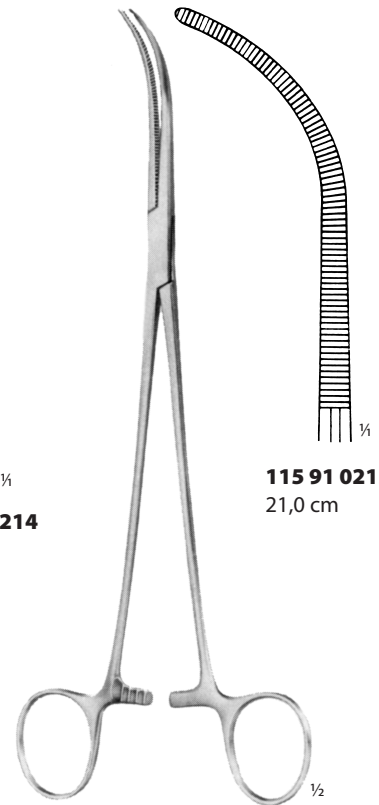

**115 91 0215**  
21,0 cm

**OVERHOLT-MIXTER**

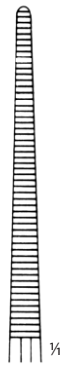

**115 91 0216**  
20,0 cm  
Fig. 1

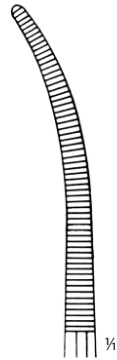

**115 91 0217**  
20,0 cm  
Fig. 2

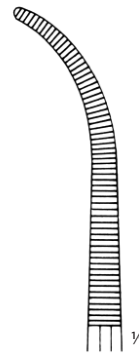

**115 91 0218**  
20,0 cm  
Fig. 3

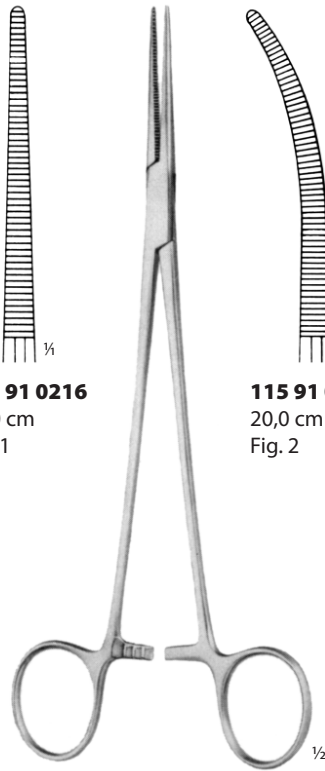

**HEISS**

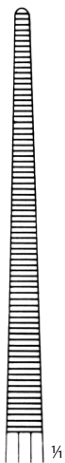

**115 91 0219**  
22,0 cm

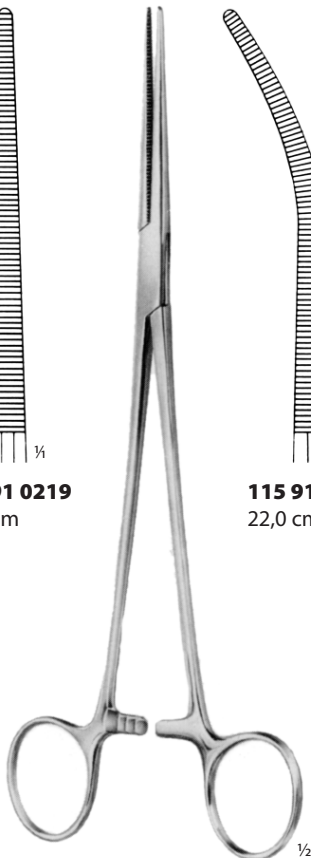

**ROBERTS**

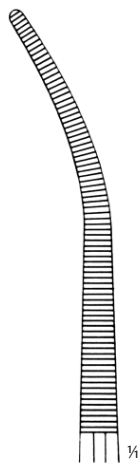

**115 91 0220**  
22,0 cm



**115 91 0221**  
24,0 cm

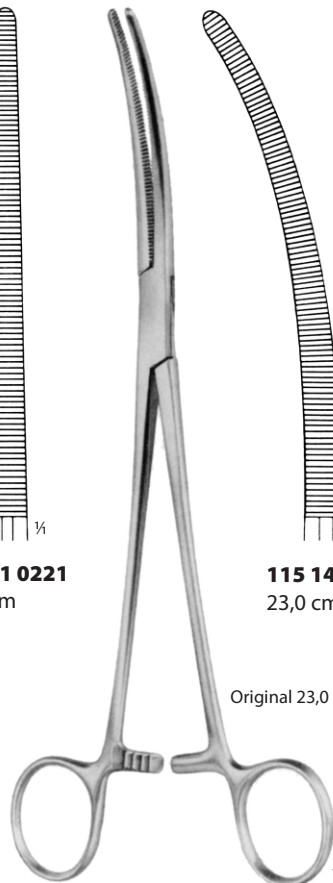

**SAROT**

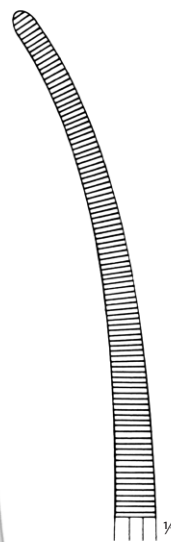

**115 14 1600**  
23,0 cm

Original 23,0 cm

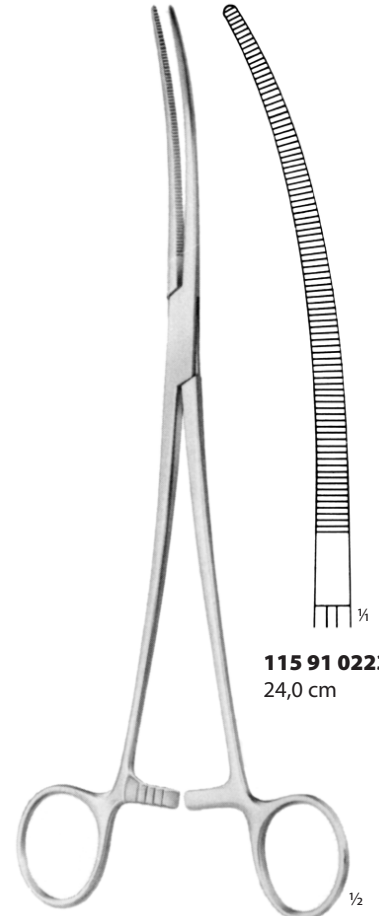

**CRAFOORD**

**115 91 0223**  
24,0 cm



**RUMEL**  
23,0 cm

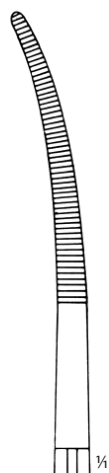

**115 91 0224**  
23,0 cm  
Fig. 1

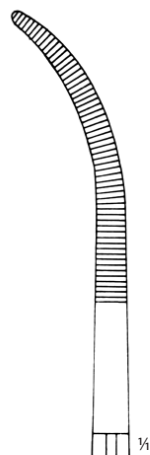

**115 91 0225**  
23,0 cm  
Fig. 2

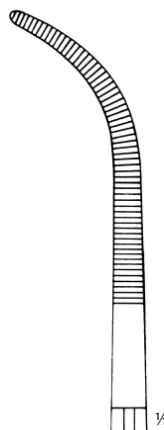

**115 91 0226**  
23,0 cm  
Fig. 3

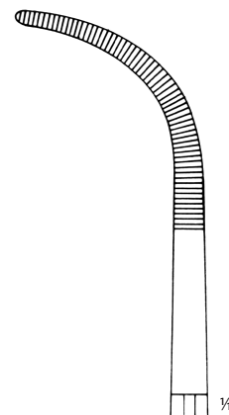

**115 91 0227**  
23,0 cm  
Fig. 4



**ZENKER**  
29,5 cm

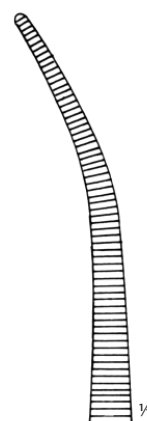

**115 91 0229**  
29,5 cm

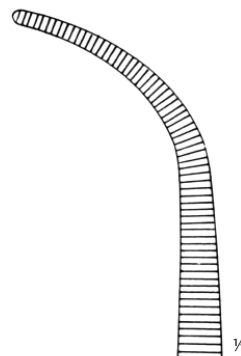

**115 91 0230**  
29,5 cm

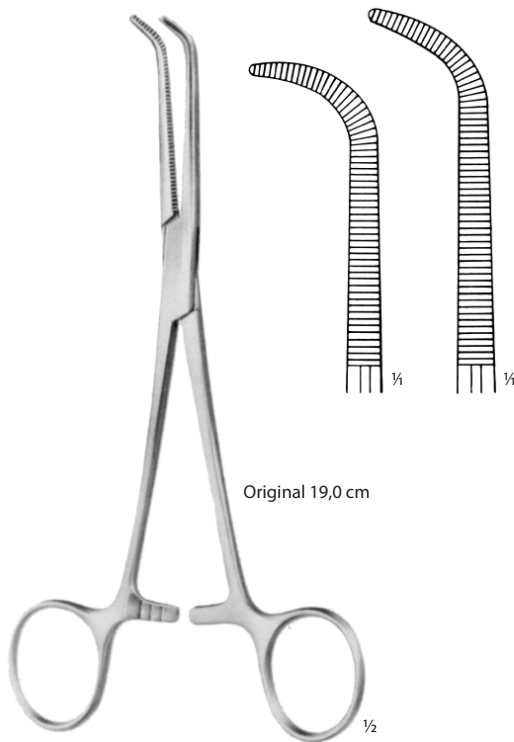

Original 19,0 cm

**MIXTER**  
115 91 0231 15,5 cm  
115 91 0232 19,0 cm

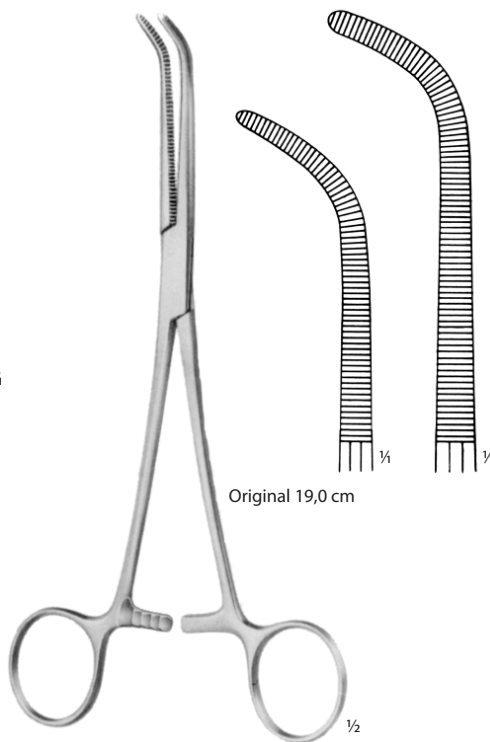

Original 19,0 cm

**MIXTER-O'SHAUGNESSY**  
115 91 0233 15,5 cm  
115 91 0234 19,0 cm

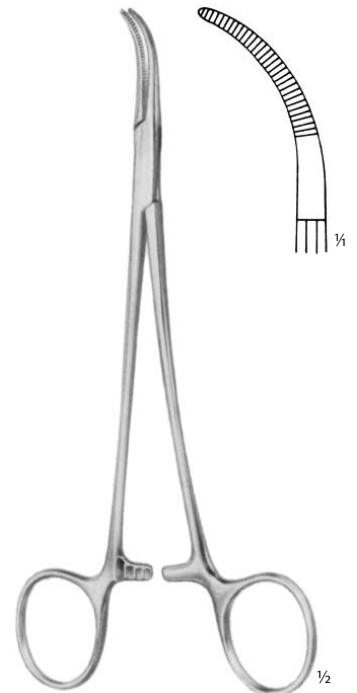

**BABY-MIXTER**  
115 91 0235  
18,0 cm

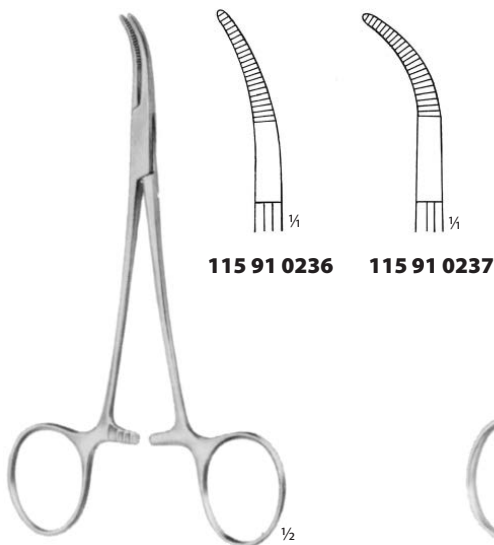

**BABY-MIXTER**  
14,0 cm



**MIXTER**  
22,0 cm

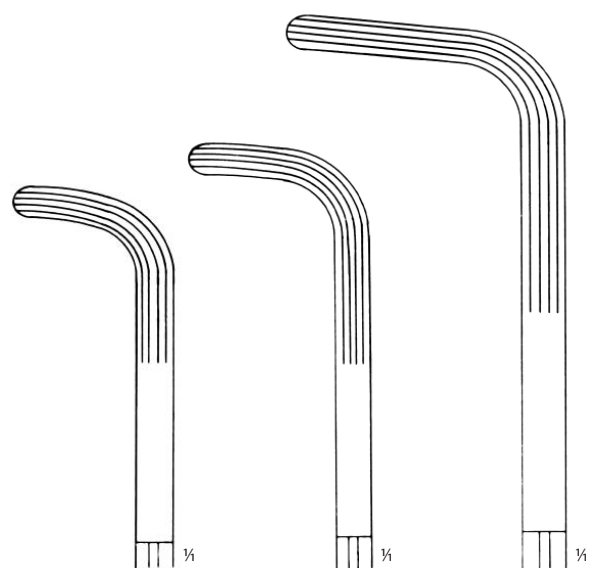

**115 91 0238**  
22,0 cm  
Fig. 1

**115 91 0239**  
25,0 cm  
Fig. 2

**115 91 0240**  
28,0 cm  
Fig. 3

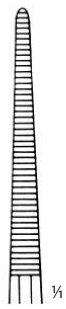

115 91 0242

**BRIDGE**  
28,0 cm

115 91 0243

**LAWRENCE**  
115 91 0244  
28,0 cm



Original 20,0 cm

**KANTROWITZ**

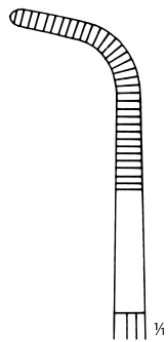

**115 91 0245**  
20,0 cm

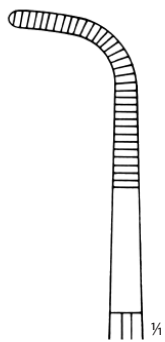

**115 91 0246**  
24,0 cm

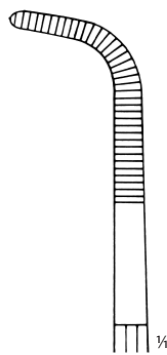

**115 91 0247**  
28,0 cm



Original 21,0 cm

**TOENNIS**

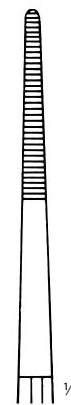

**115 91 0253**  
**115 91 0254**  
21,0 cm  
26,0 cm

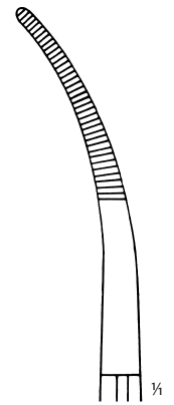

**115 91 0255**  
**115 91 0256**



Original 18,0 cm

**GEMINI**

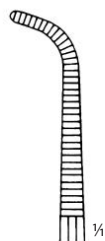

**115 91 0249**  
18,0 cm

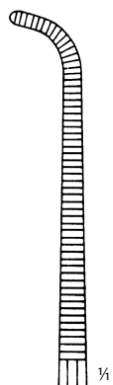

**115 91 0251**  
25,0 cm

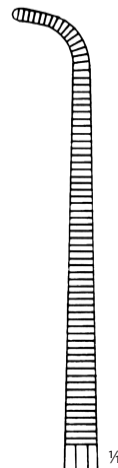

**115 91 0252**  
28,0 cm



Original 21,0 cm

**TOENNIS**

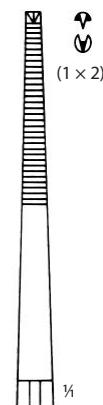

**115 91 0257**  
**115 91 0258**  
21,0 cm  
26,0 cm

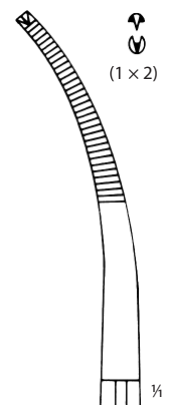

**115 91 0259**  
**115 91 0260**

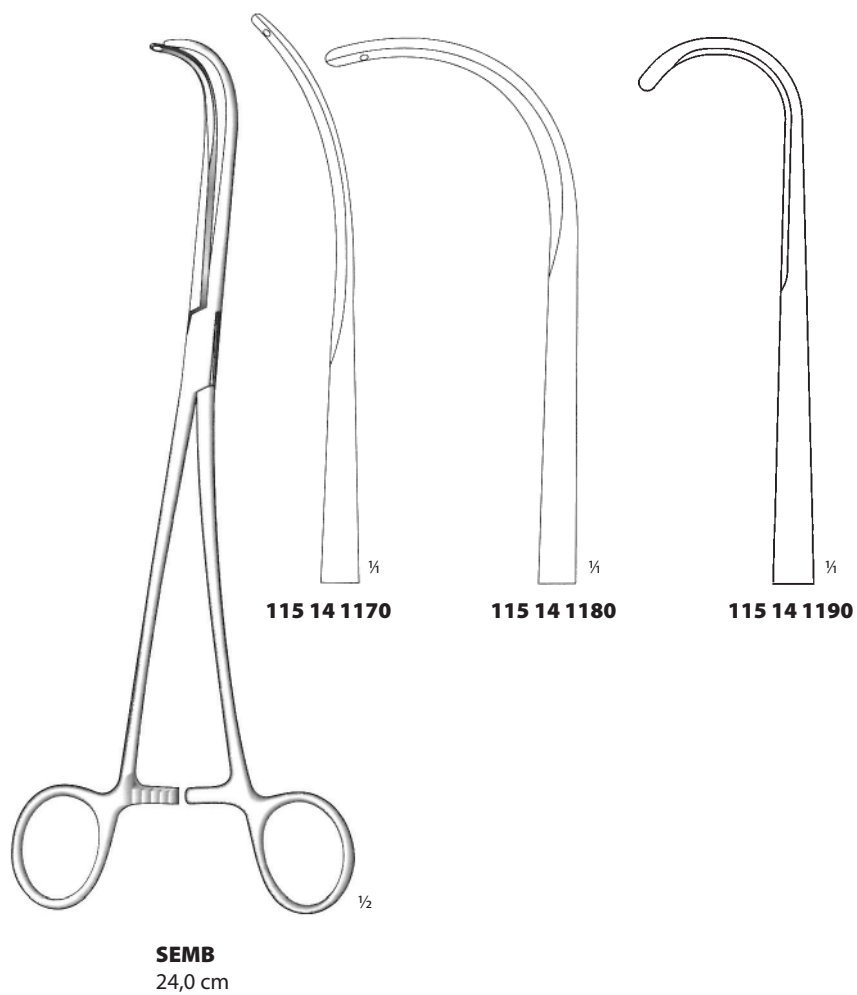



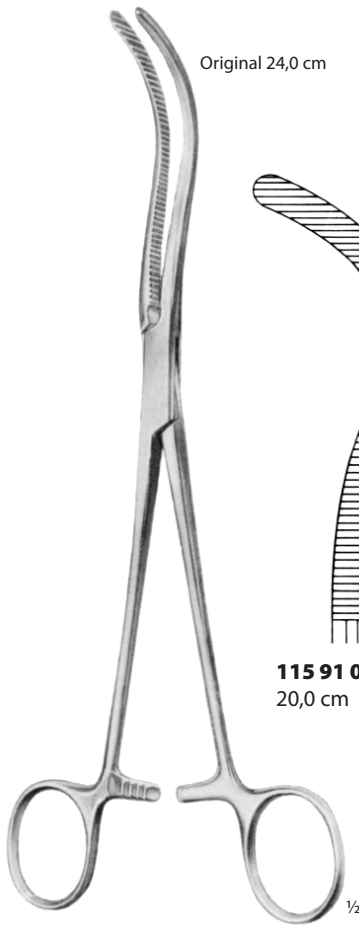

**GUYON**

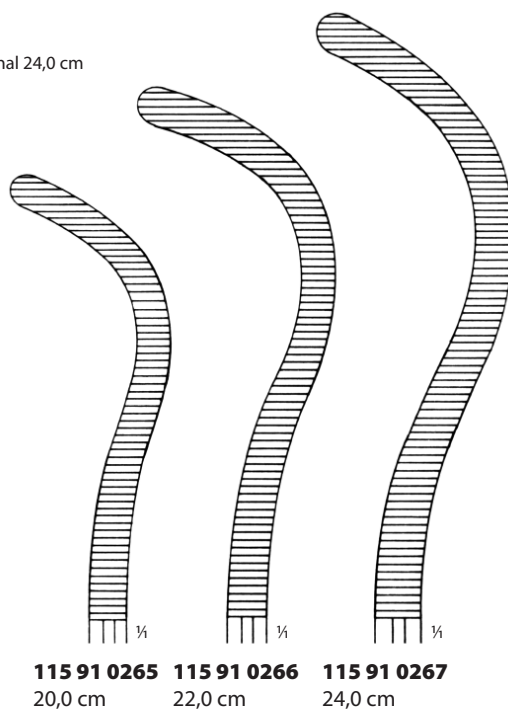

**STILLE**

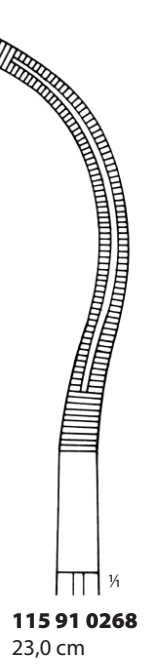

**GUYON**

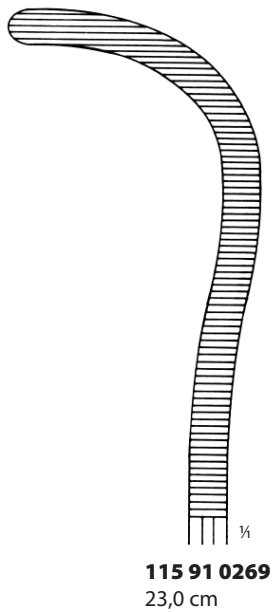

**HERRICK**

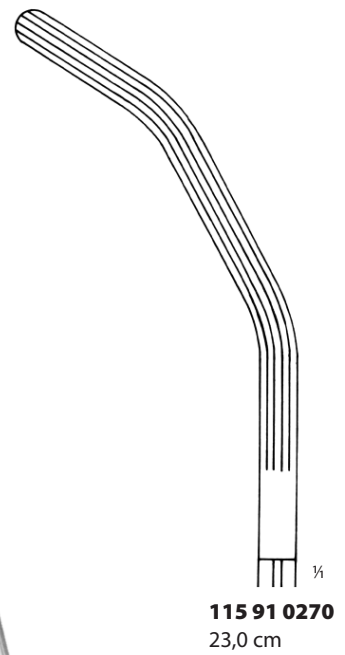

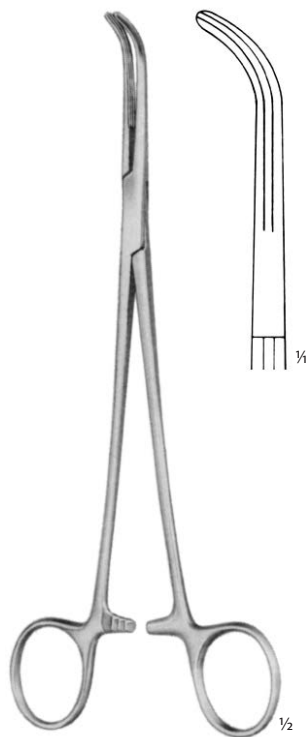

**LAHEY**  
**115 91 0261**  
19,0 cm



**LAHEY**  
**115 91 0262**  
23,0 cm



**LOWER**  
**115 91 0263**  
18,0 cm

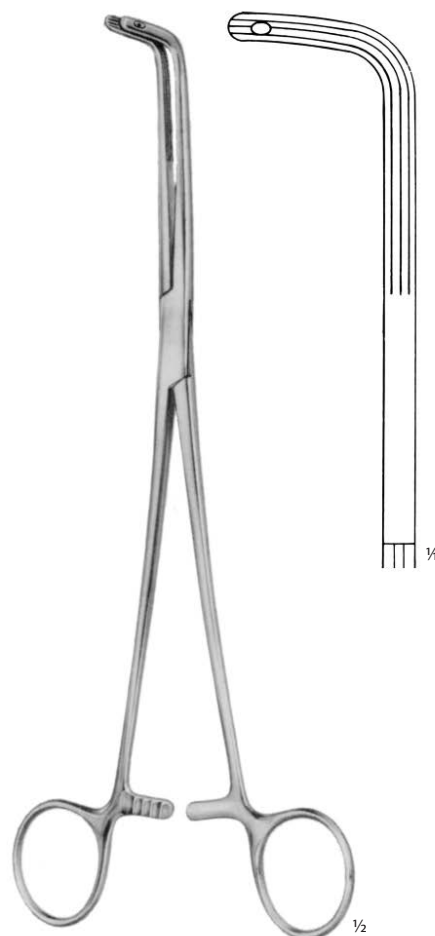

**FINOCHIETTO**  
**115 91 0264**  
24,0 cm

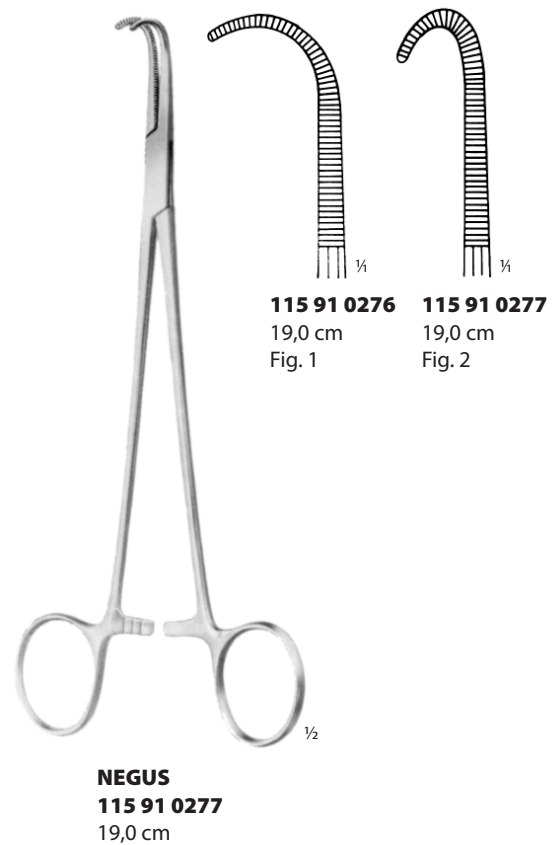
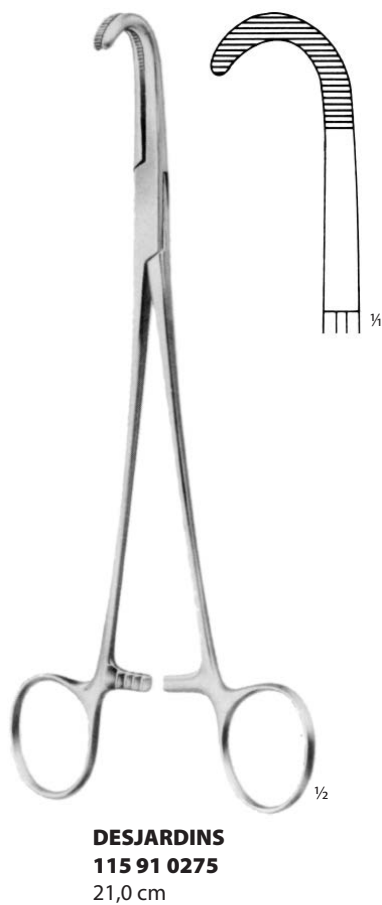
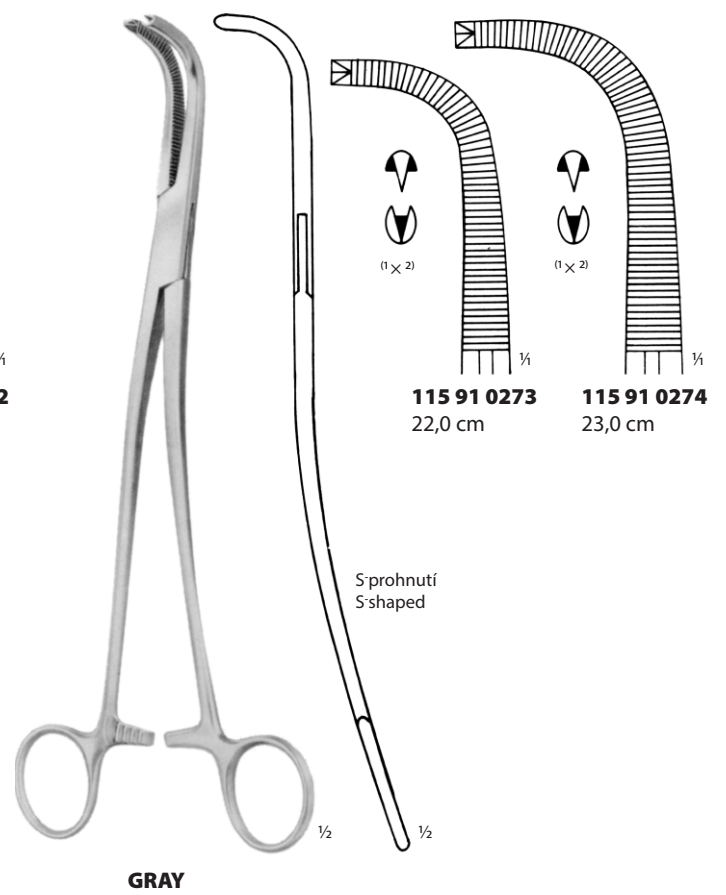
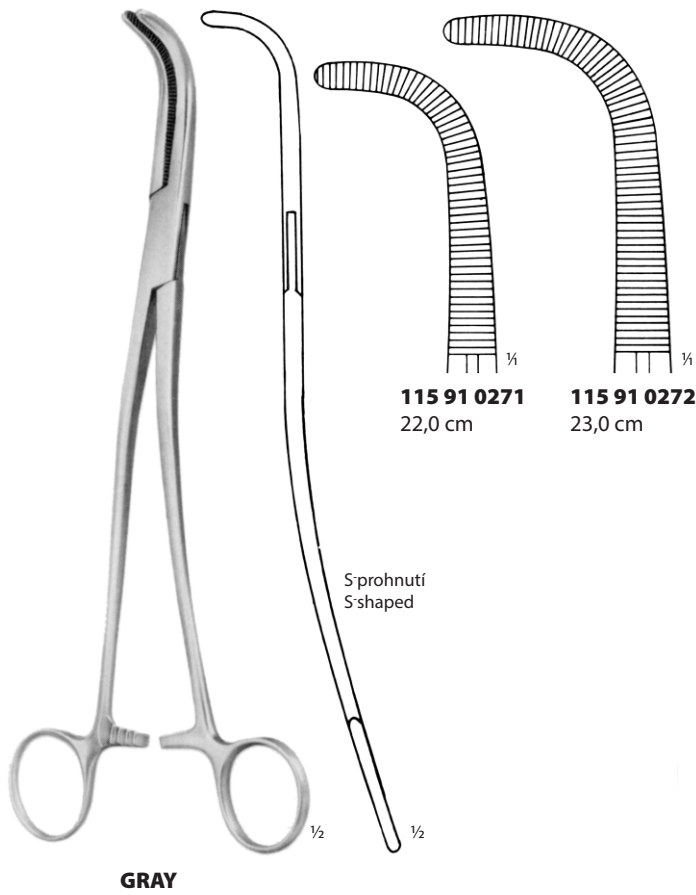

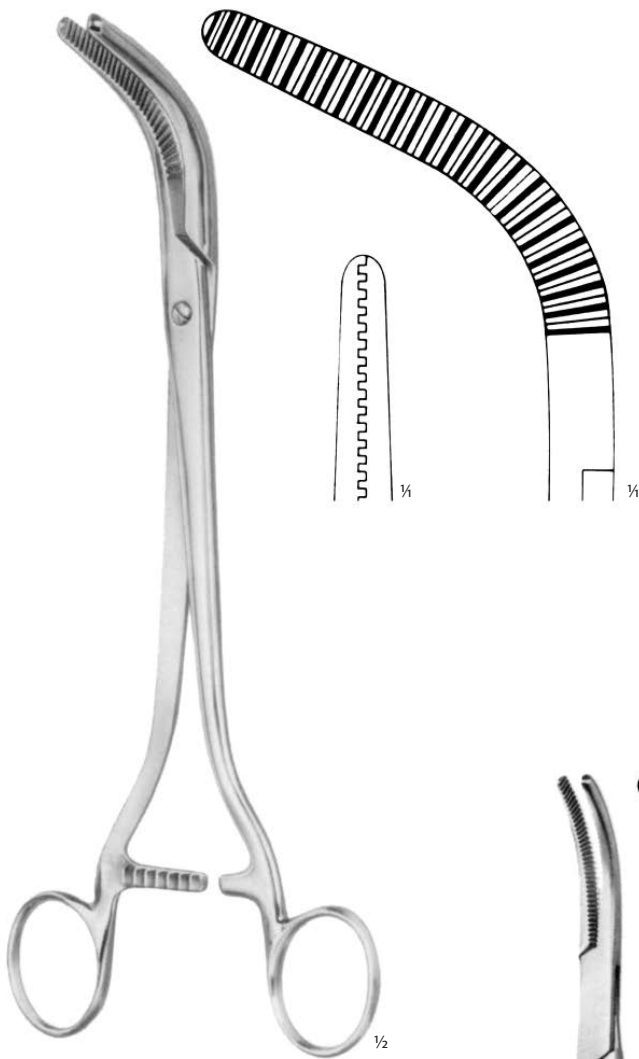

**WERTHEIM**  
**115 91 0281**  
27,0 cm

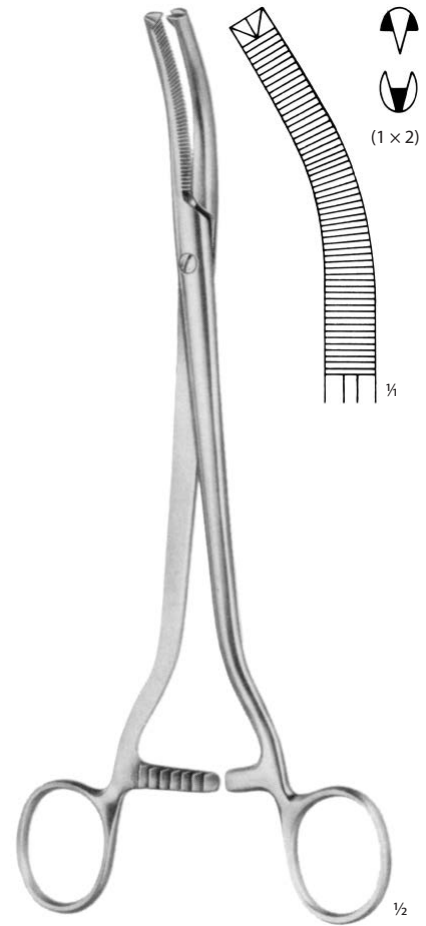

**WERTHEIM**  
**115 91 0282**  
24,0 cm

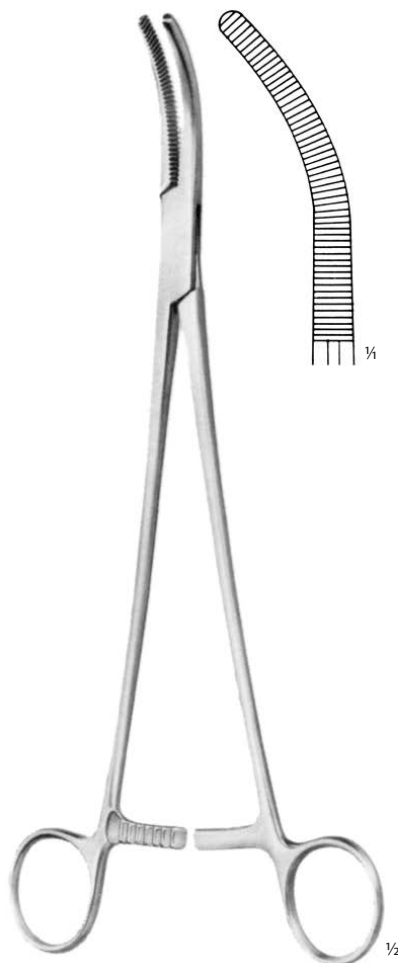

**WERTHEIM**  
**115 91 0283**  
25,0 cm

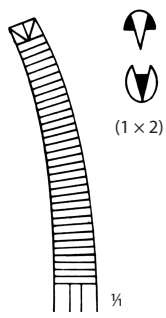

**115 91 0284**  
lehce zahnuté  
slightly curved

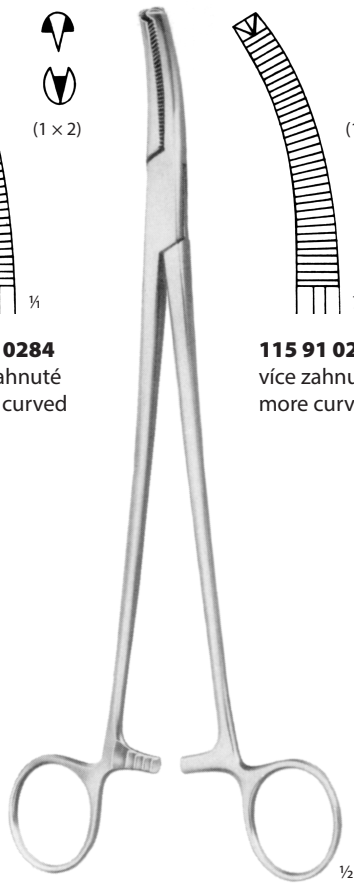

**WERTHEIM**  
23,0 cm

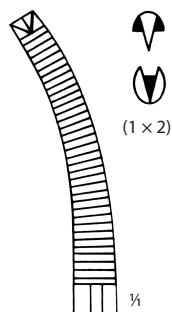

**115 91 0285**  
více zahnuté  
more curved

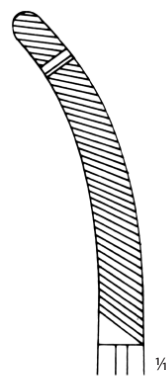

**HEANEY**  
**115 91 0287** 21,0 cm  
**115 91 0288** 23,0 cm

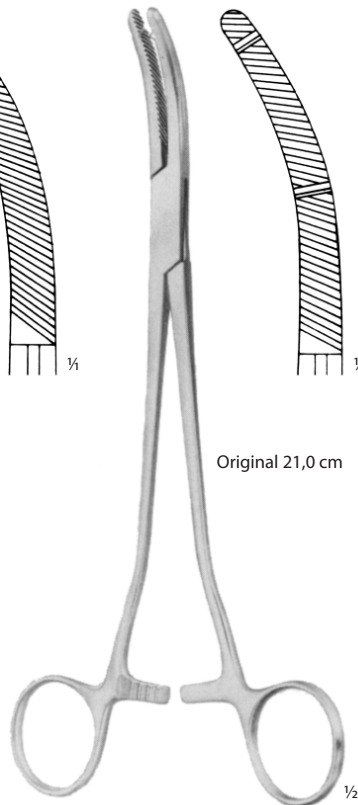

Original 21,0 cm

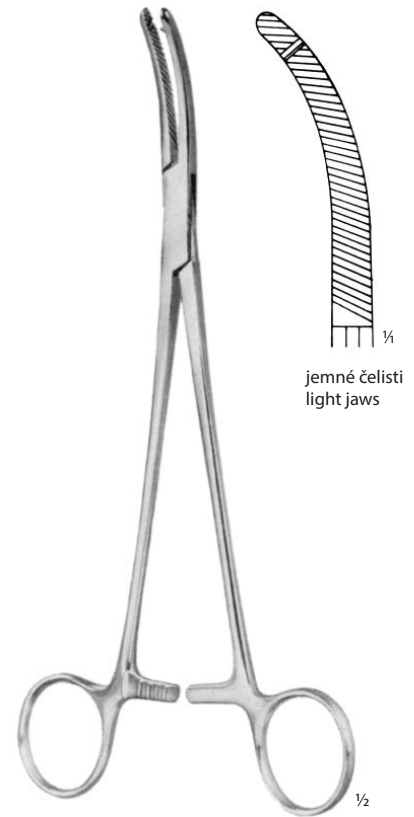

**HEANEY**  
**115 91 0286**  
21,0 cm

jemné čelisti  
light jaws

SVORKY NA HYSTEREKTOMII  
HYSTERECTOMY CLAMP-FORCEPS

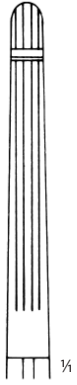

115 91 0291

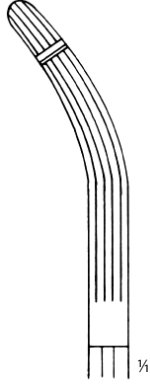

115 91 0292

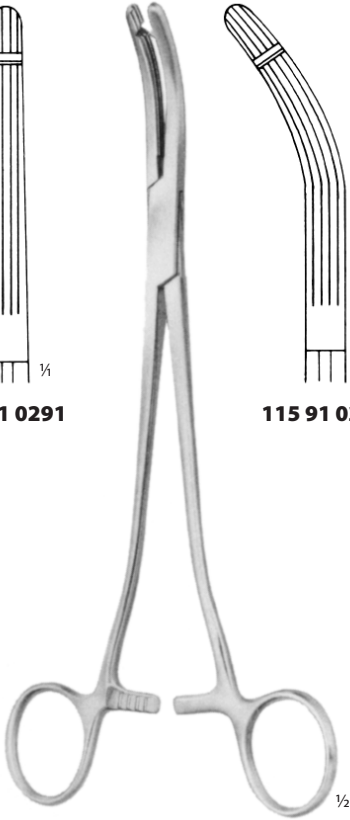

**HEANEY-BALANTINE**  
21,0 cm

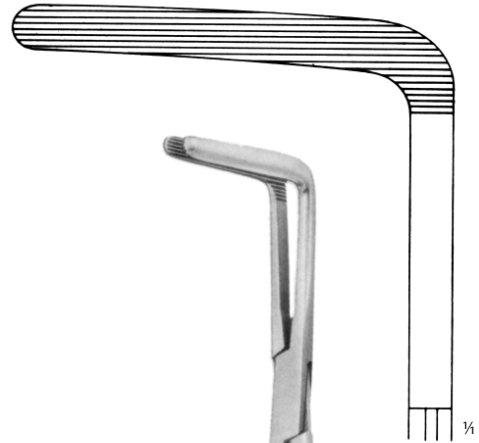

**WERTHEIM-CULLEN**  
115 91 0299  
21,5 cm

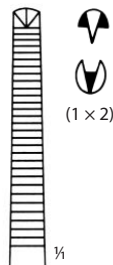

115 91 0300

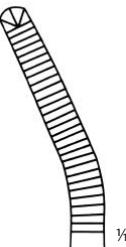

115 91 0301

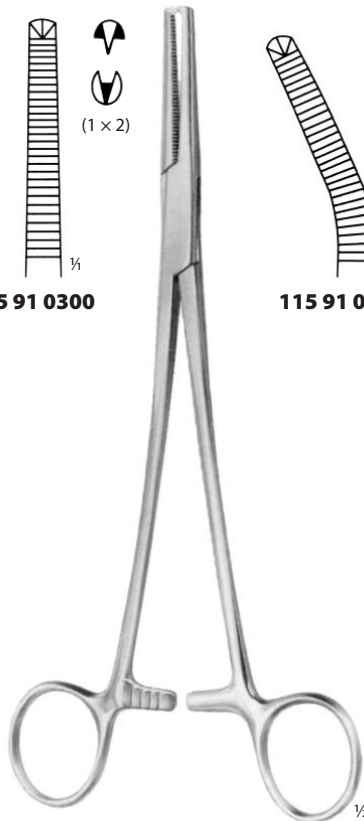

**PHANEUF**  
21,5 cm

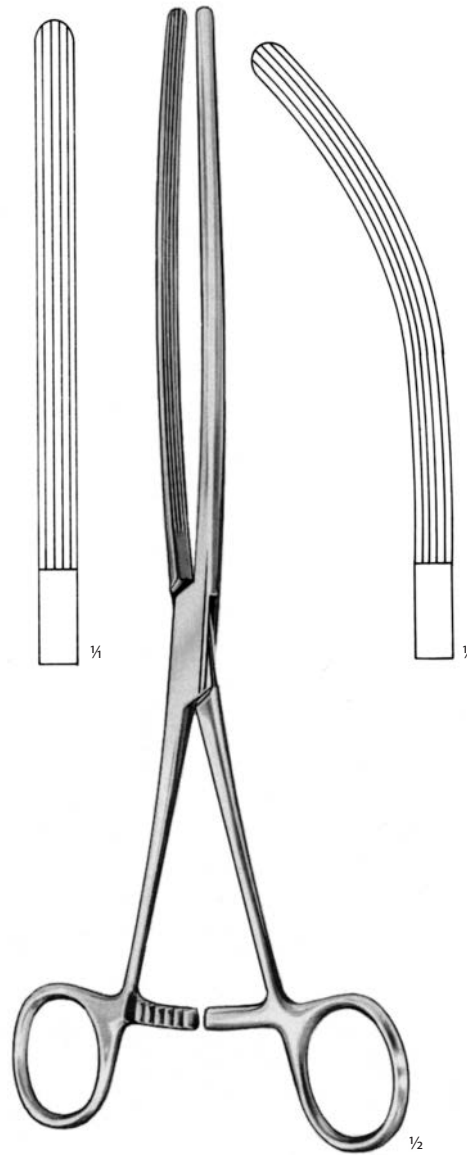

**MAYO-ROBSON**

přímé  
**115 91 0403**  
**115 91 0404**  
**115 91 0405**

21,0 cm  
23,0 cm  
25,0 cm

zahnuté  
**115 91 0406**  
**115 91 0407**  
**115 91 0408**

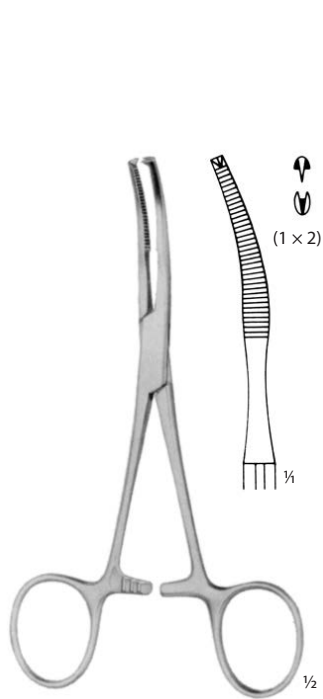
SVORKY NA POBŘÍŠNÍCI  
PERITONEAL CLAMP-FORCEPS

**BABY-MIKULICZ**  
**115 91 0322**  
14,0 cm

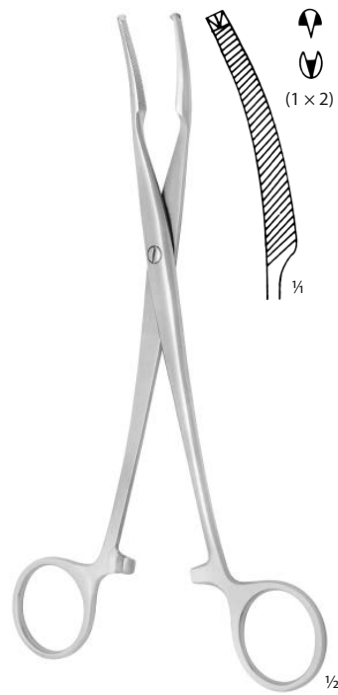

**MIKULICZ**  
**115 27 0070**  
18,0 cm

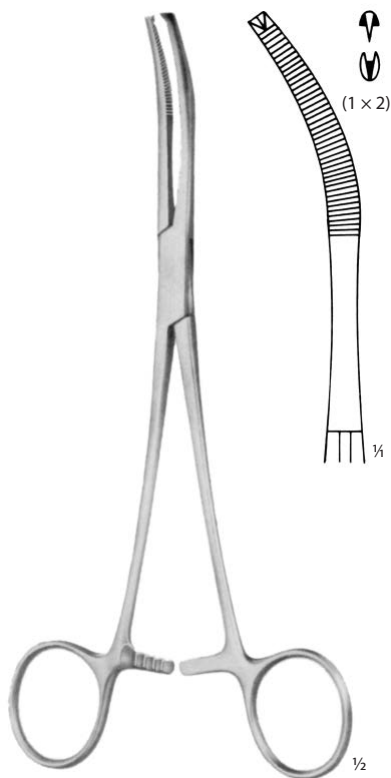

**MIKULICZ**  
**115 91 0326**  
20,0 cm

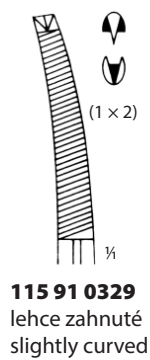

**115 91 0329**  
lehce zahnuté  
slightly curved

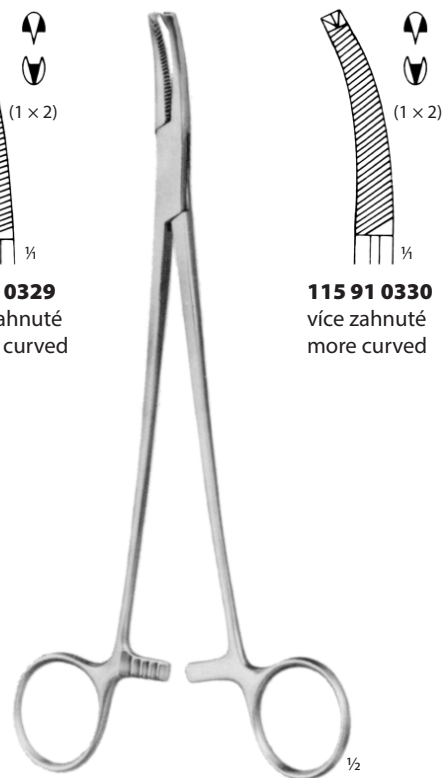

**FAURE**  
20,0 cm

**115 91 0330**  
více zahnuté  
more curved



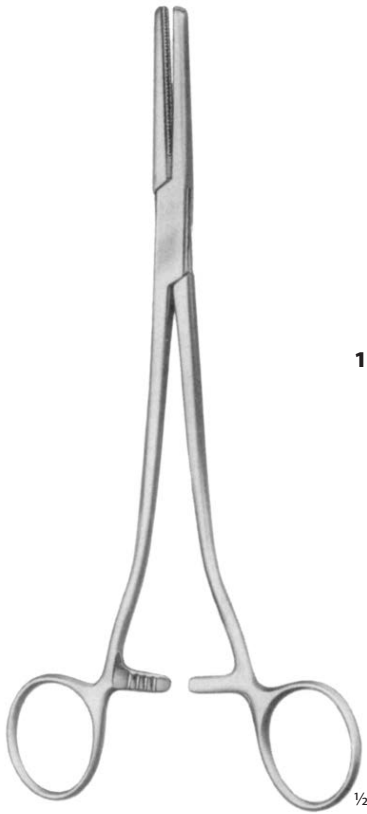

**PARAMETRIUM**  
21,0 cm

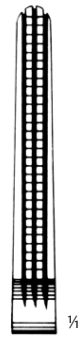

**115 91 0305**

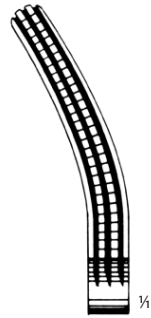

**115 91 0306**  
Fig. 1

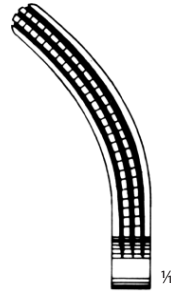

**115 91 0307**  
Fig. 2

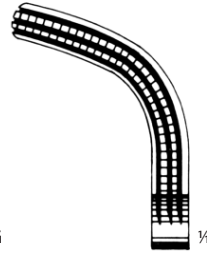

**115 91 0308**  
Fig. 3

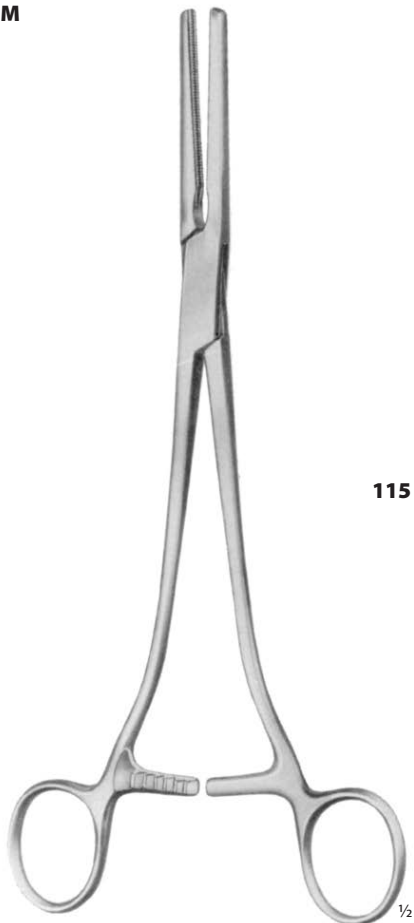

**PARAMETRIUM**  
24,0 cm

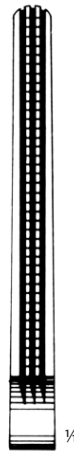

**115 91 0309**

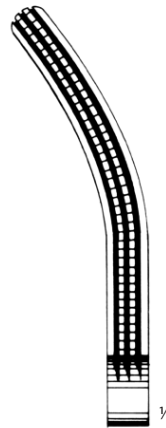

**115 91 0310**  
Fig. 1

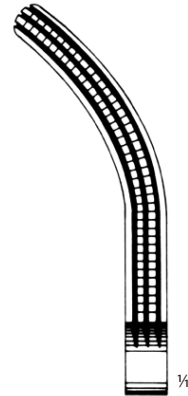

**115 91 0311**  
Fig. 2

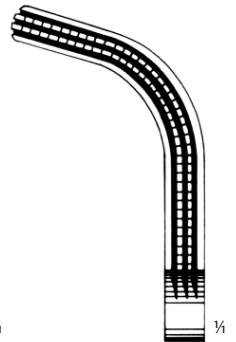

**115 91 0312**  
Fig. 3

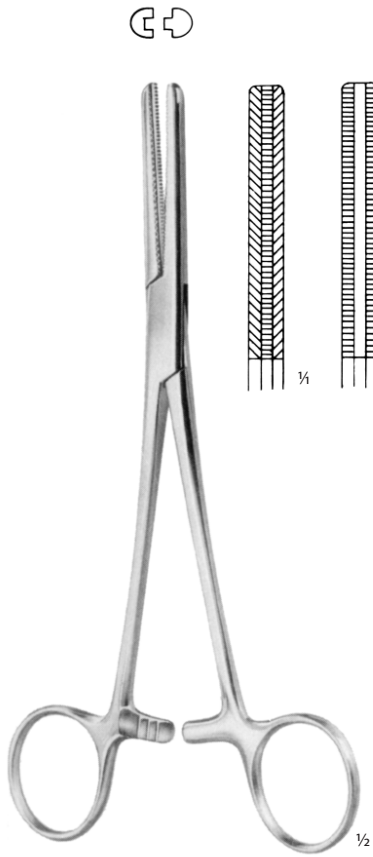

**FERGUSSON**  
**115 91 0313**  
16,0 cm

**115 91 0314**  
20,0 cm

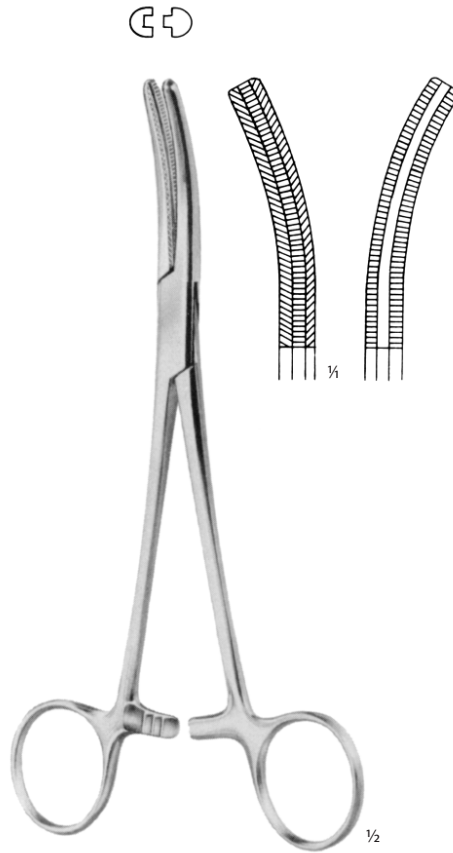

**FERGUSSON**  
**115 91 0315**  
16,0 cm

**115 91 0316**  
20,0 cm



**PRATT**  
**115 91 0317**  
15,0 cm



DE BAKEY



DE BAKEY

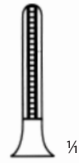

**115 91 0600**  
7,5 cm

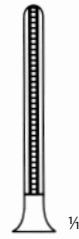

**115 91 0601**  
8,5 cm

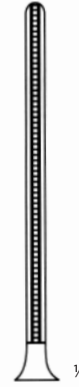

**115 91 0602**  
10,5 cm

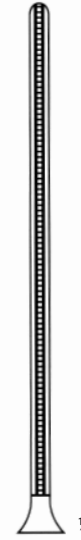

**115 91 0603**  
12,0 cm



DE BAKEY



**115 91 0604**  
7,0 cm



**115 91 0605**  
8,0 cm

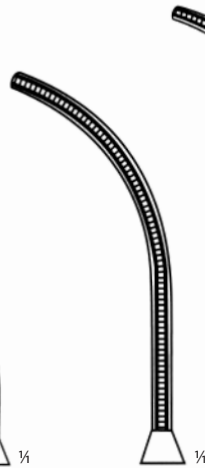

**115 91 0606**  
10,0 cm

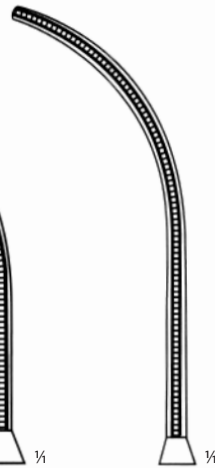

**115 91 0607**  
11,5 cm



**SANTULLI**  
**115 91 0608**  
7,0 cm

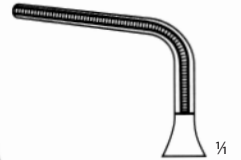

SVORKY ATRAUMATICKÉ NA CÉVY  
ARTERY FORCEPS ATRAUMATIC JAWS



DE BAKEY



GLOVER



**115 91 0609**  
6,0 cm



**115 91 0610**  
7,0 cm



**115 91 0611**  
9,0 cm



**115 91 0612**  
11,0 cm



GLOVER



**115 91 0613**  
5,5 cm



**115 91 0614**  
6,5 cm



**115 91 0615**  
8,5 cm



**115 91 0616**  
10,5 cm

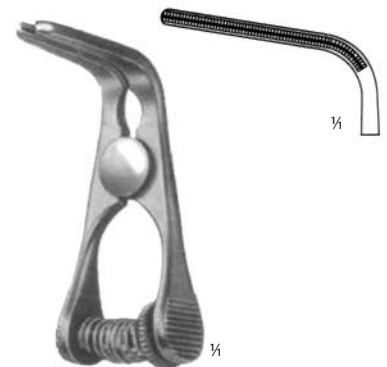

**GLOVER**  
**115 91 0617**  
5,0 cm



DE BAKEY

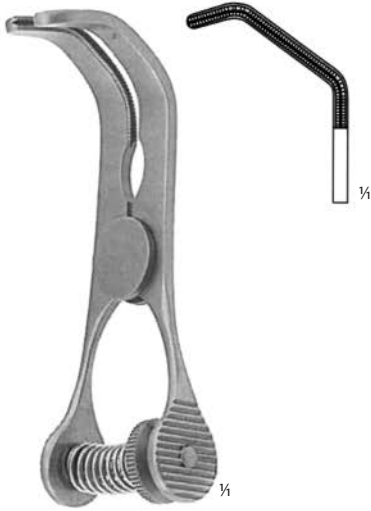

**DE BAKEY-SATINSKY**  
**115 91 0618**  
7,0 cm

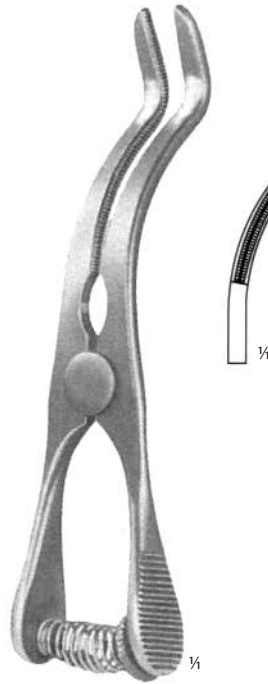

**DE BAKEY-CAROTIS**  
**115 91 0619**  
9,0 cm

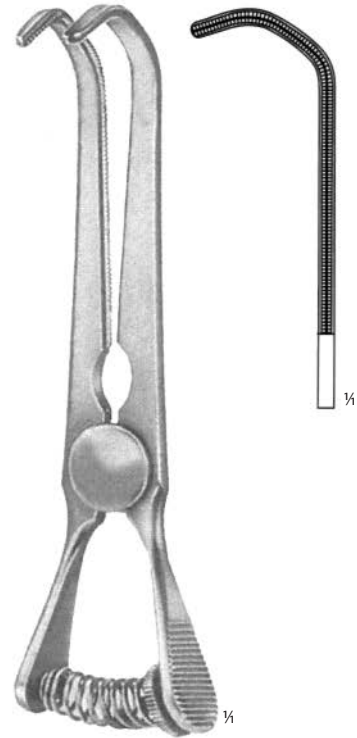

**DE BAKEY-SATINSKY**  
**115 91 0620**  
10,0 cm



**GREGORY-SOFT**

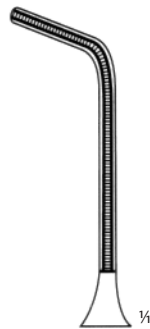

**115 91 0621**  
9,0 cm

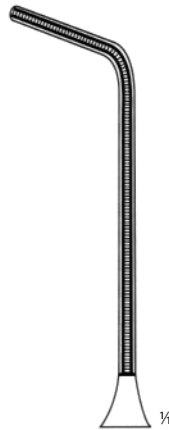

**115 91 0622**  
11,0 cm



**115 91 0623**  
11,0 cm



**115 91 0624**  
11,0 cm

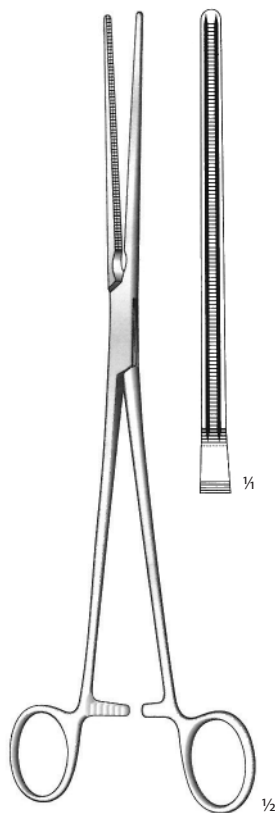
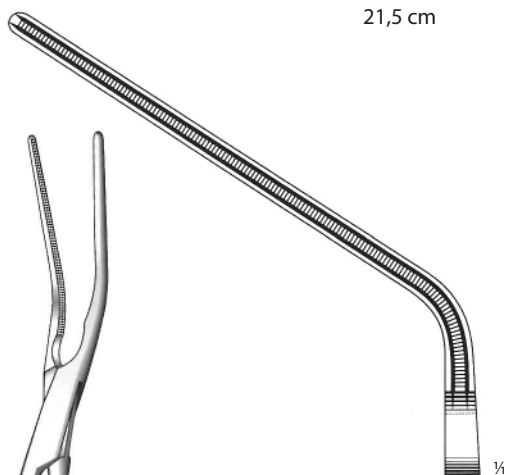
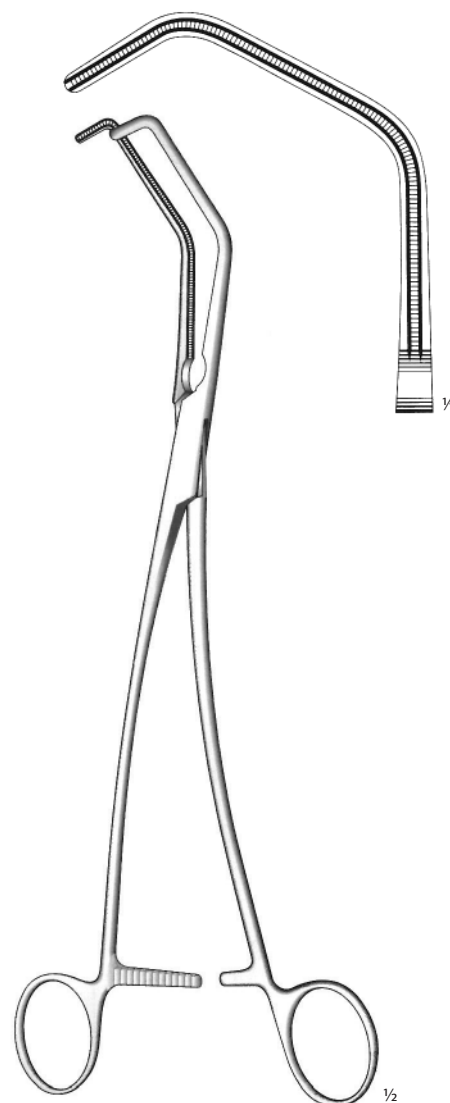

DE BAKEY

115 14 1410  
21,5 cm115 14 1460  
21,0 cm115 14 1490  
24,0 cm



DE BAKEY

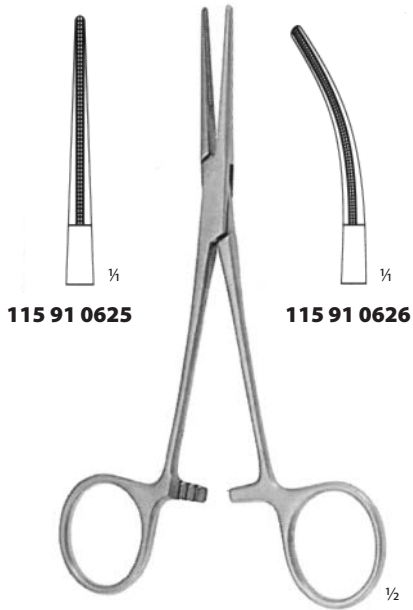

**DE BAKEY-RANKIN**  
16,0 cm

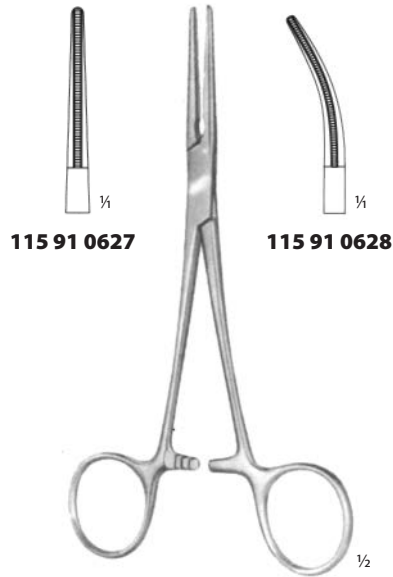

**DE BAKEY-MOSQUITO**  
15,0 cm

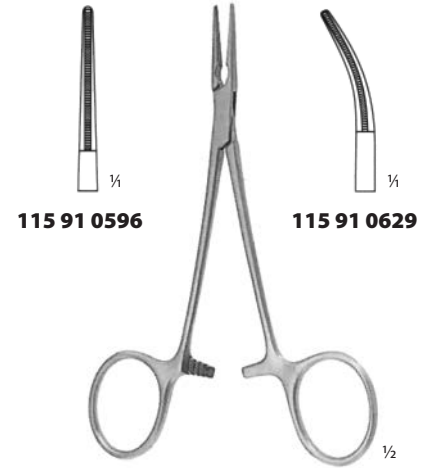

**DE BAKEY-MOSQUITO**  
12,0 cm

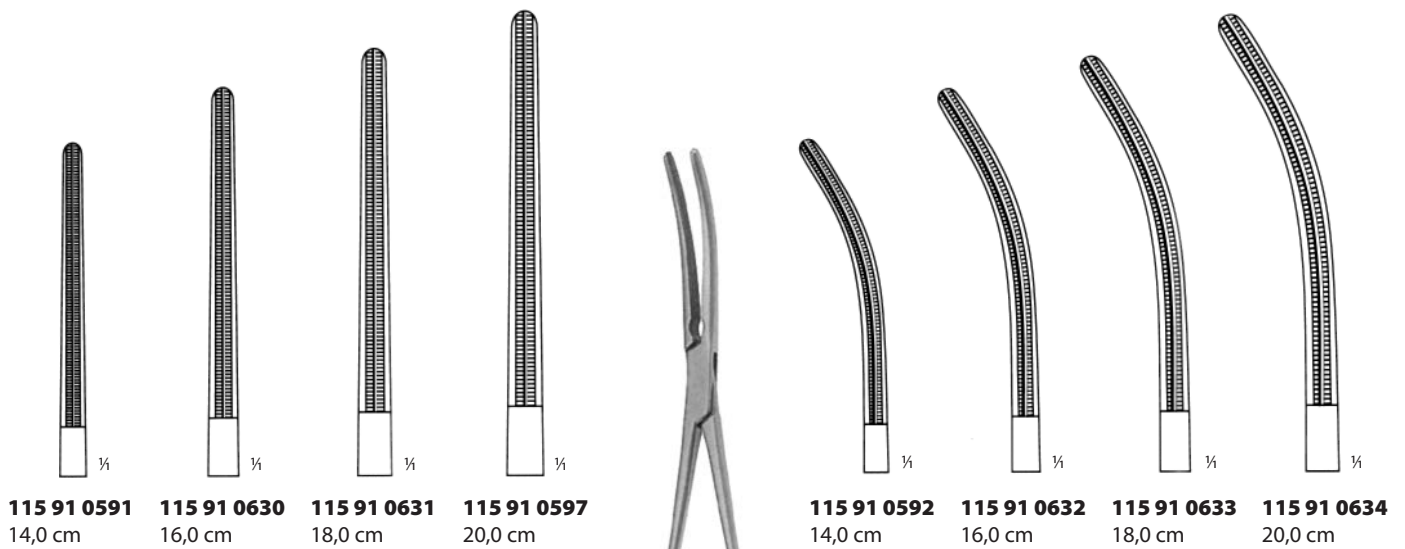

**DE BAKEY-PEAN**

SVORKY ATRAUMATICKÉ NA CÉVY  
ARTERY FORCEPS ATRAUMATIC JAWS



DE BAKEY

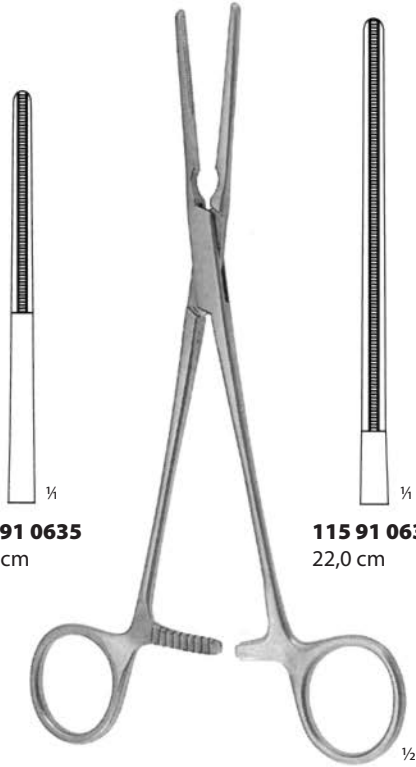

**115 91 0635**  
21,0 cm

**115 91 0636**  
22,0 cm

POTTS



**115 91 0637**  
21,0 cm

**115 91 0638**  
22,0 cm

POTTS

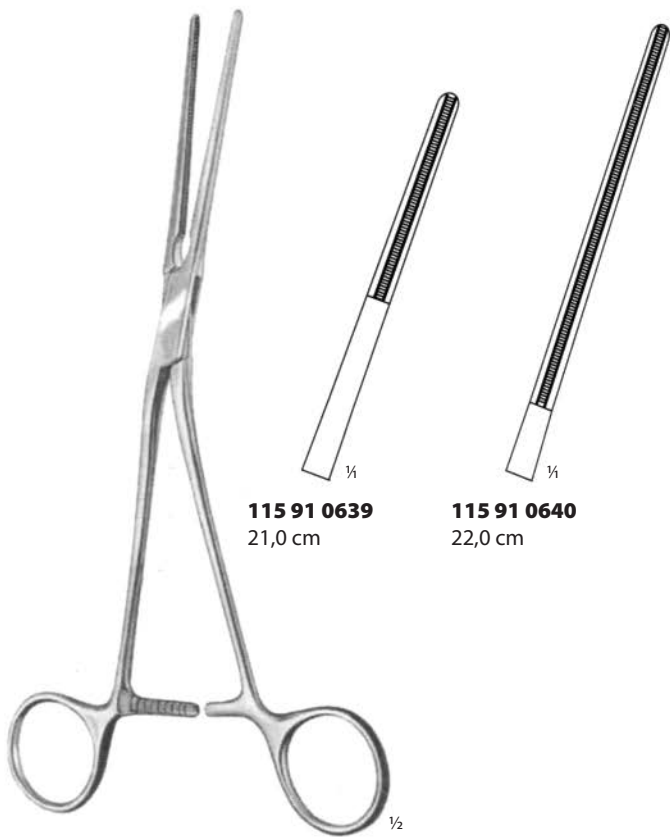

**115 91 0639**  
21,0 cm

**115 91 0640**  
22,0 cm

POTTS

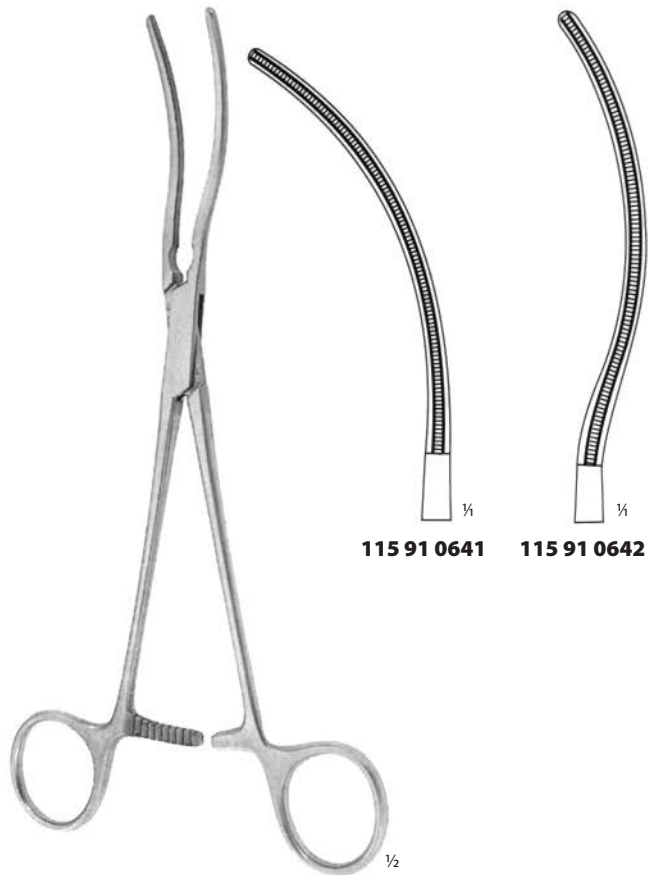

**115 91 0641**

**115 91 0642**

POTTS  
22,0 cm





DE BAKEY



DE BAKEY

**115 91 0643**  
19,0 cm

1/2



1/4



**115 91 0644**  
23,0 cm

1/4



**DE BAKEY**  
**115 91 0645**  
16,0 cm

1/2



1/4

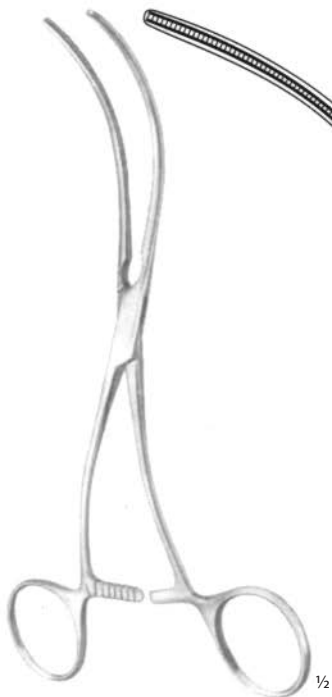

DE BAKEY

**115 91 0646**  
19,0 cm

1/2



1/4

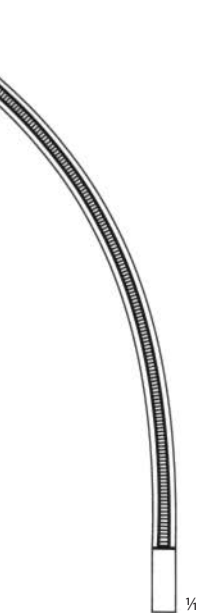

**115 91 0490**  
20,0 cm

1/4



**DE BAKEY**  
**115 91 0647**  
20,0 cm

1/2



1/4

SVORKY ATRAUMATICKÉ NA CÉVY  
ARTERY FORCEPS ATRAUMATIC JAWS



DE BAKEY

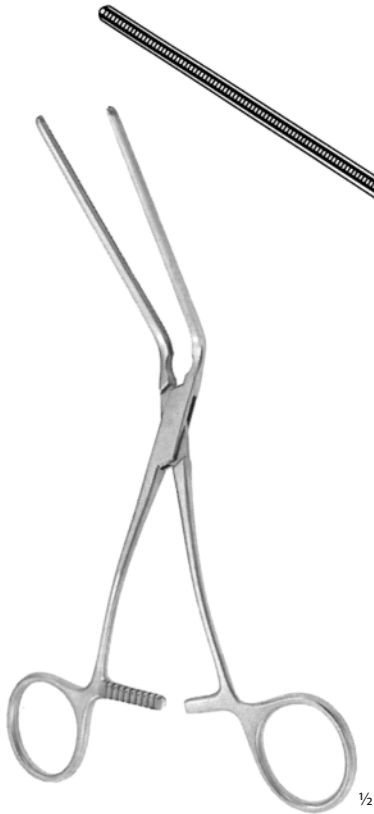

LELAND-JONES



BAINBRIDGE

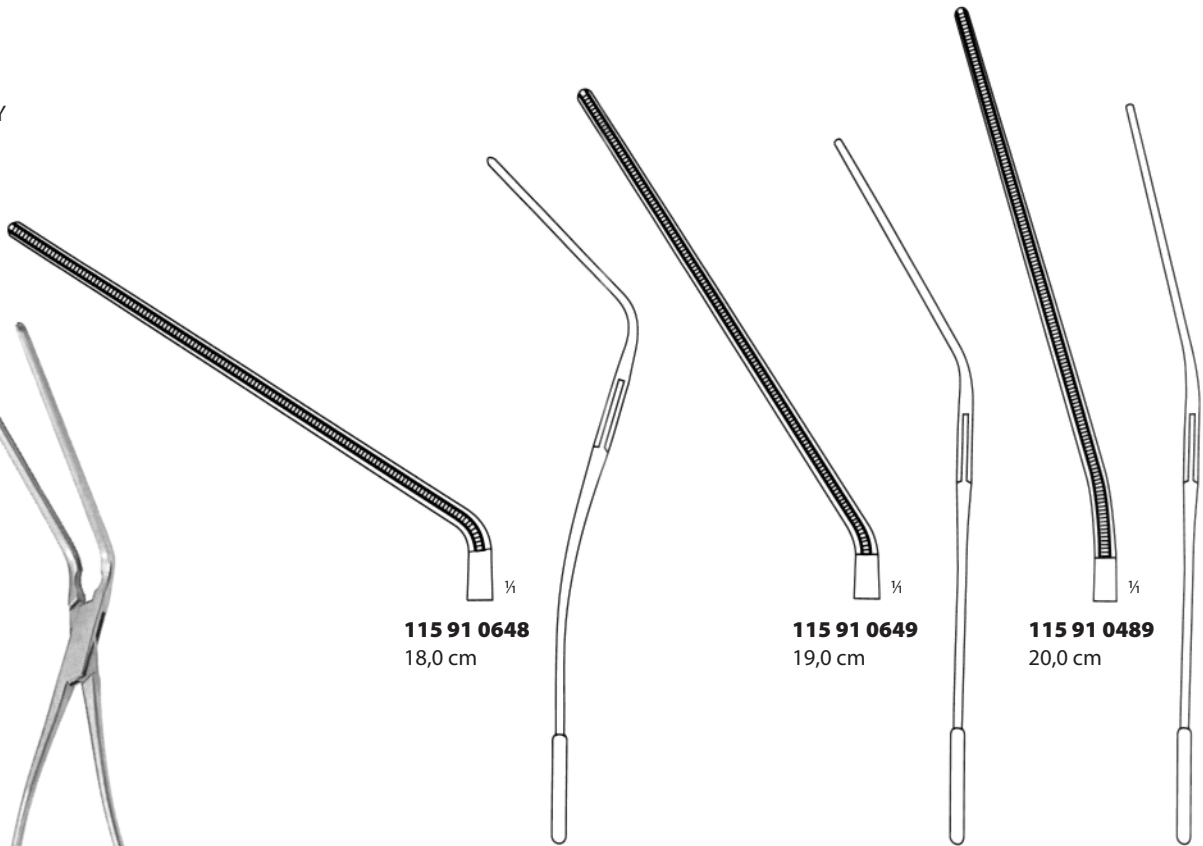

**115 91 0648**  
18,0 cm

**115 91 0649**  
19,0 cm

**115 91 0489**  
20,0 cm

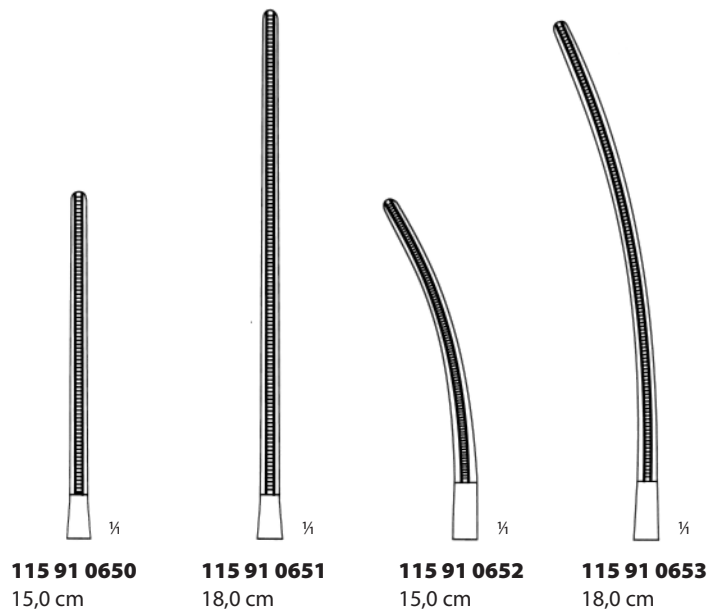

**115 91 0650**  
15,0 cm

**115 91 0651**  
18,0 cm

**115 91 0652**  
15,0 cm

**115 91 0653**  
18,0 cm



DE BAKEY





DE BAKEY

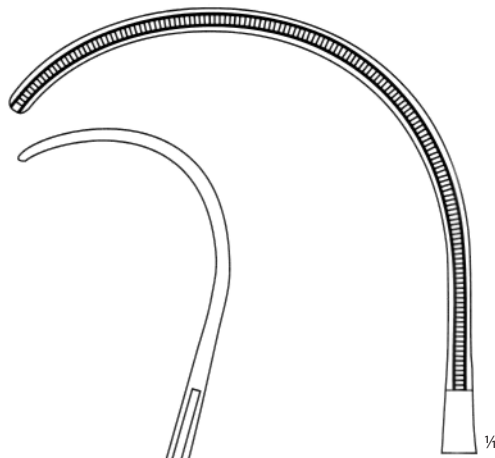
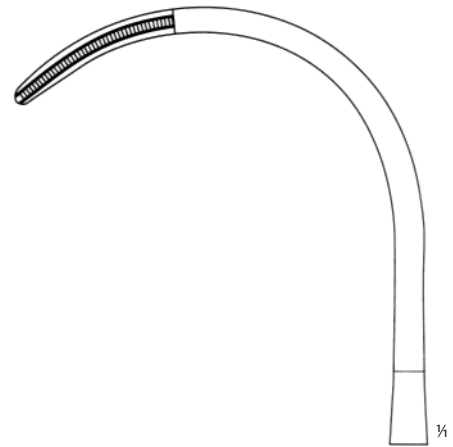

DE BAKEY

115 91 0658  
25,0 cm115 91 0659  
26,0 cm

DE BAKEY

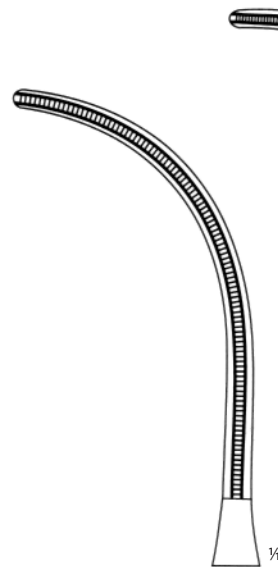
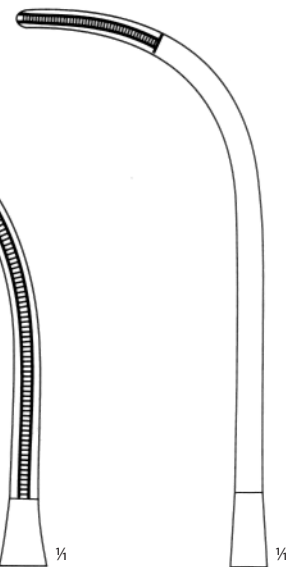
115 91 0660  
24,0 cm115 91 0661  
24,0 cm



DE BAKEY

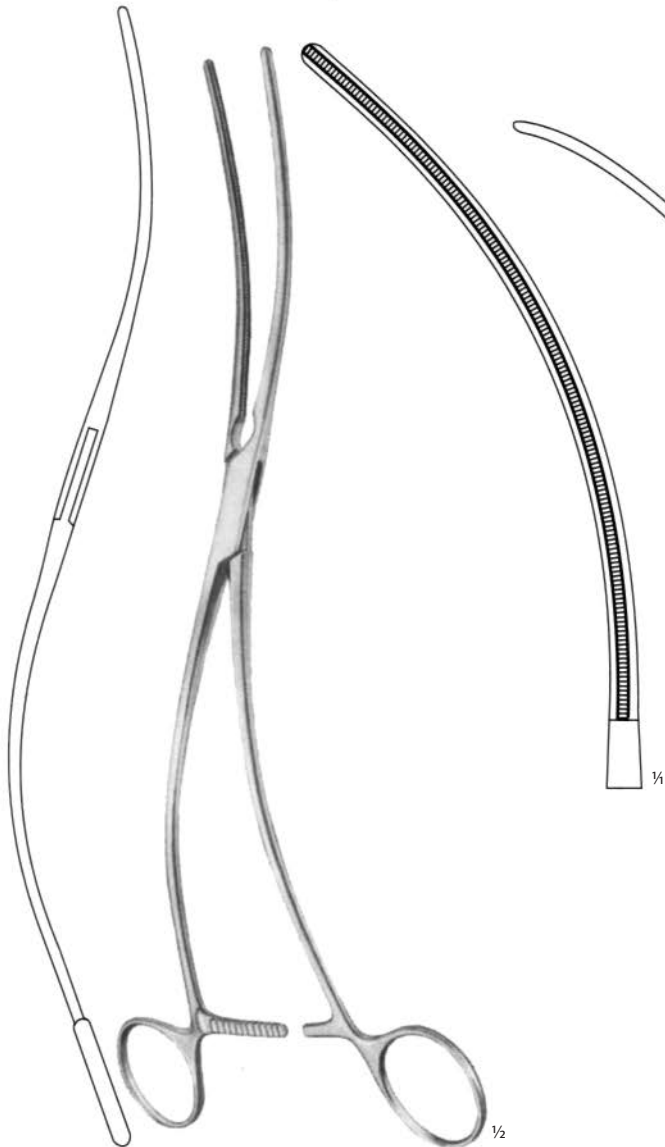

**DE BAKEY**  
**115 91 0662**  
30,0 cm

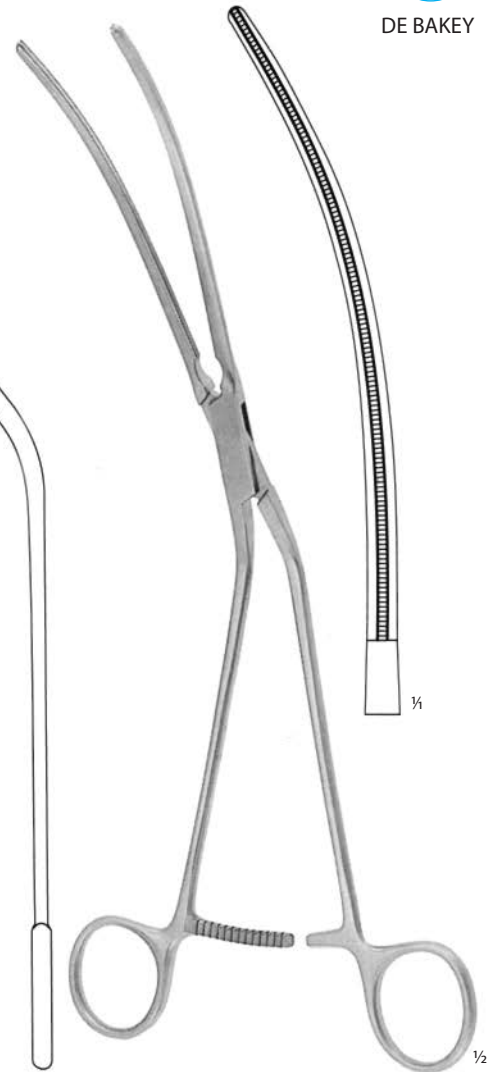

**DE BAKEY**  
**115 91 0663**  
28,0 cm

SVORKY ATRAUMATICKÉ NA CÉVY  
ARTERY FORCEPS ATRAUMATIC JAWS



DE BAKEY



DE BAKEY



115 91 0664  
21,0 cm



115 91 0665  
23,0 cm



115 91 0666  
27,0 cm

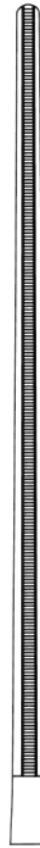

115 91 0667  
31,0 cm



DE BAKEY



115 91 0668  
18,0 cm

115 91 0669  
19,0 cm

115 91 0670  
23,0 cm

115 91 0671  
27,0 cm

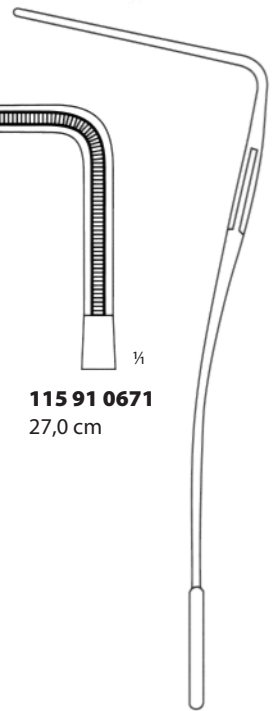



DE BAKEY

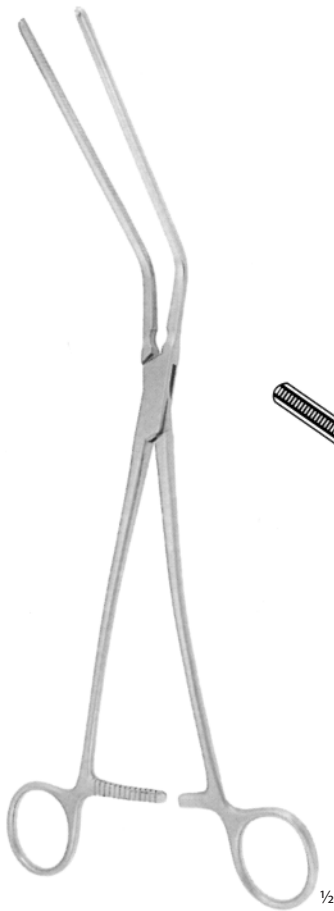

DE BAKEY

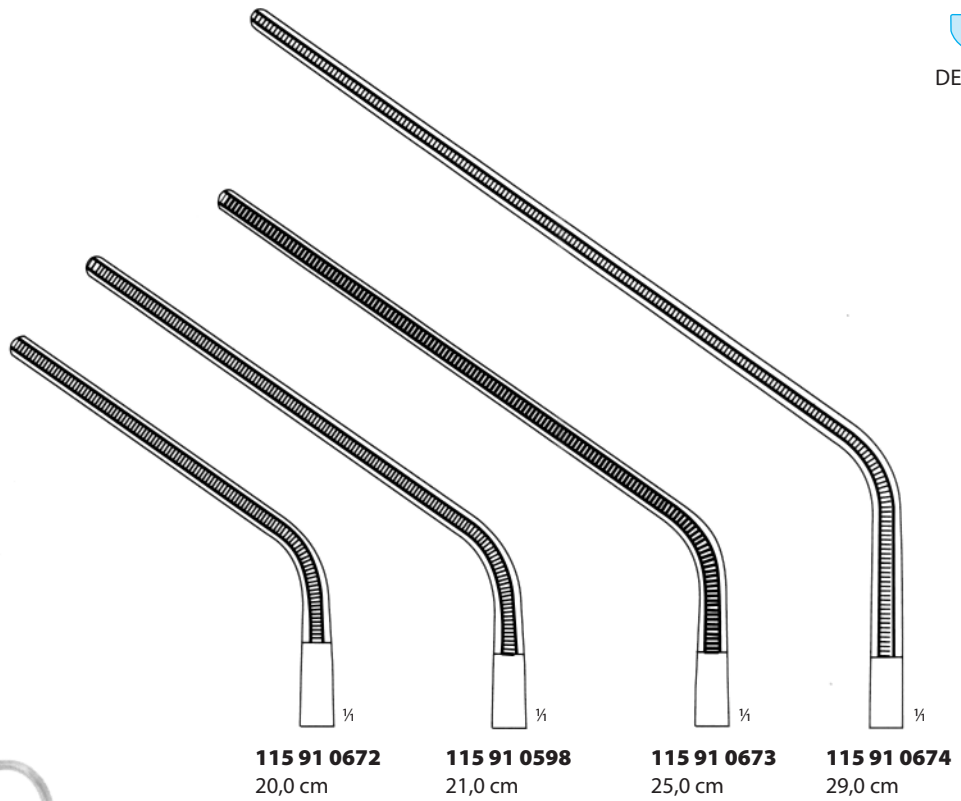

115 91 0672  
20,0 cm

115 91 0598  
21,0 cm

115 91 0673  
25,0 cm

115 91 0674  
29,0 cm



DE BAKEY

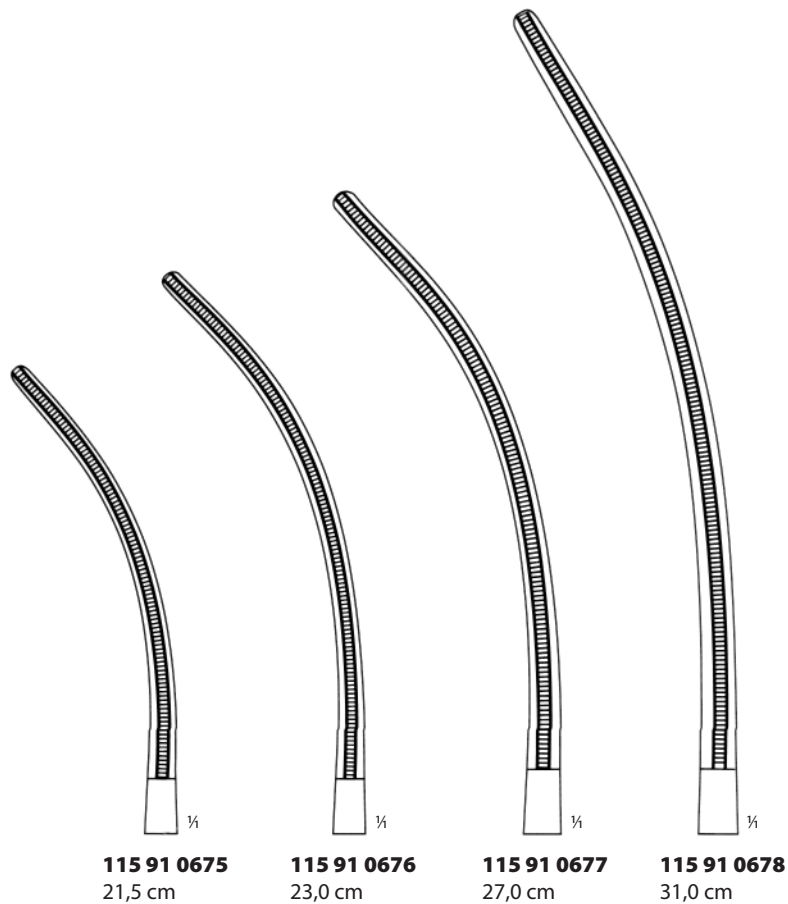

115 91 0675  
21,5 cm

115 91 0676  
23,0 cm

115 91 0677  
27,0 cm

115 91 0678  
31,0 cm

SVORKY ATRAUMATICKÉ NA CÉVY  
ARTERY FORCEPS ATRAUMATIC JAWS



DE BAKEY

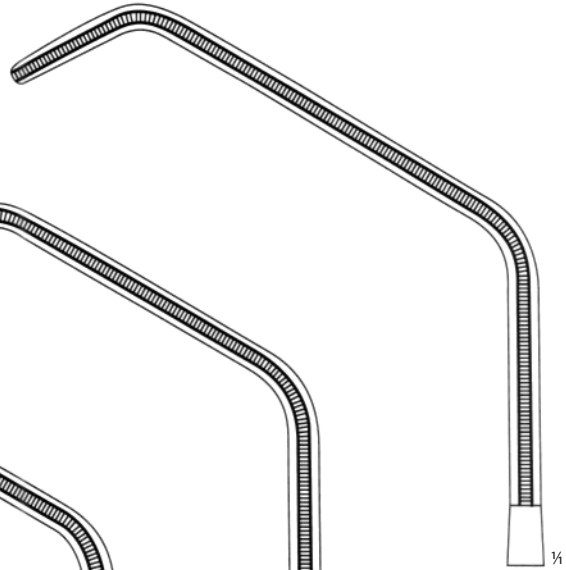

**115 91 0681**  
27,5 cm

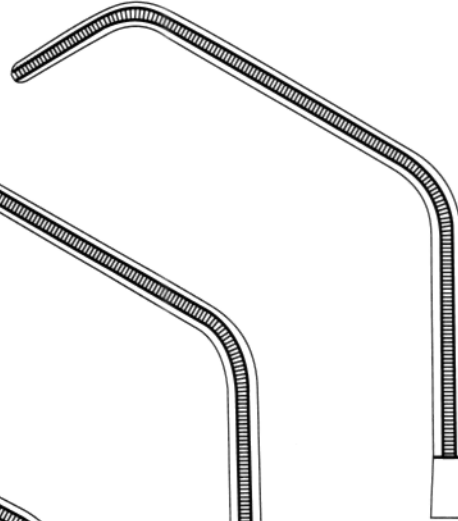

**115 91 0680**  
26,5 cm

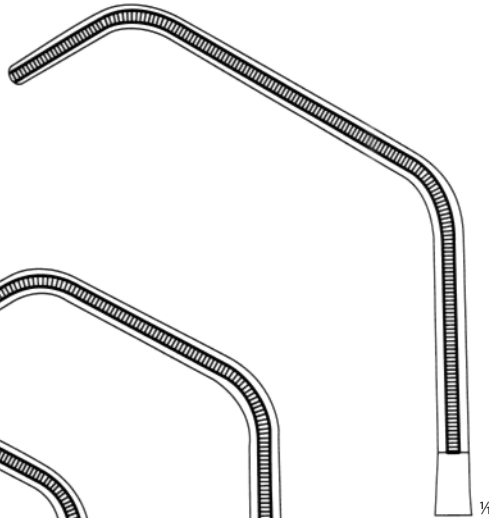

**115 91 0679**  
25,0 cm



**115 91 0488**  
24,0 cm

**115 91 0492**  
20,5 cm



SATINSKY







DE BAKEY

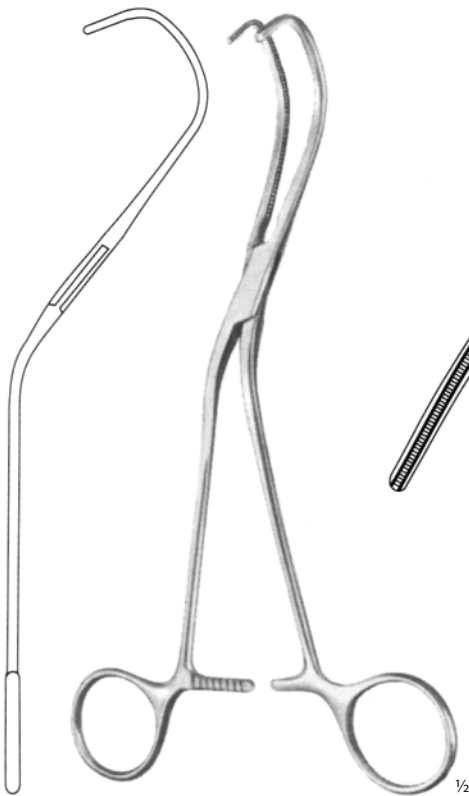

**LAMBERT-KAY**

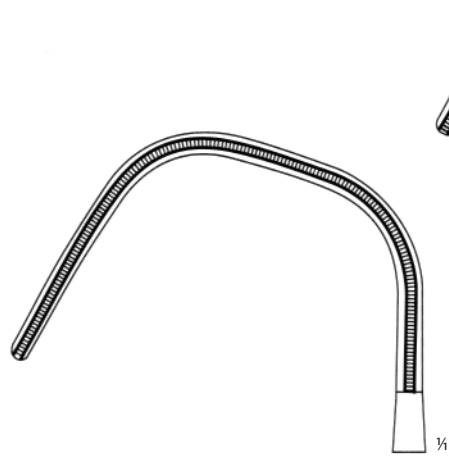

**115 91 0682**  
21,0 cm

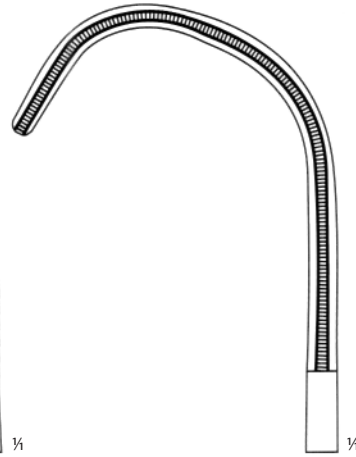

**115 91 0683**  
21,0 cm

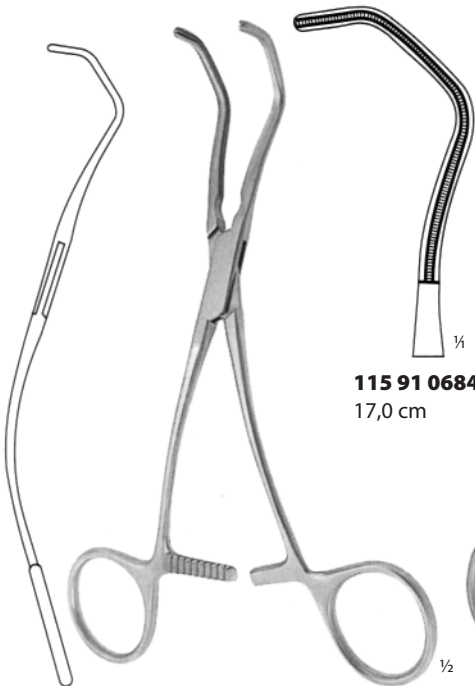

**115 91 0684**  
17,0 cm

**DE BAKEY**



**DE BAKEY-BAHNSON**

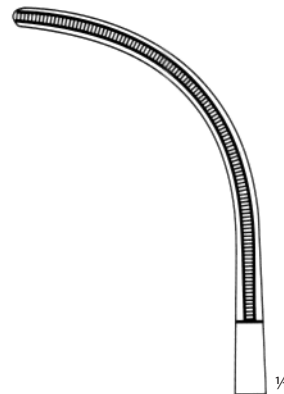

**115 91 0685**  
23,0 cm

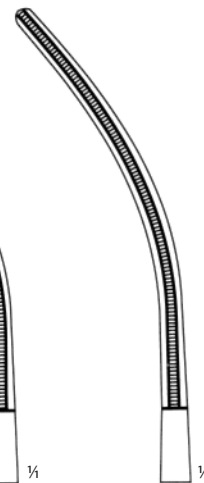

**115 91 0686**  
24,0 cm

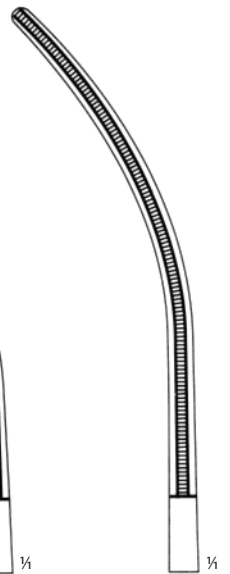

**115 91 0687**  
25,0 cm

SVORKY ATRAUMATICKÉ NA CÉVY  
ARTERY FORCEPS ATRAUMATIC JAWS

DE BAKEY

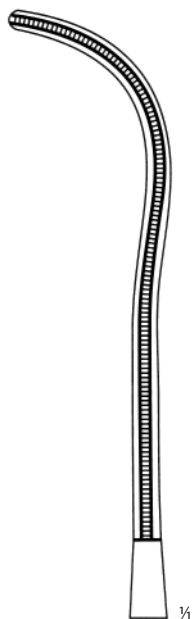
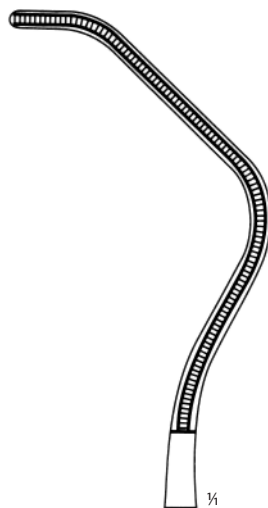
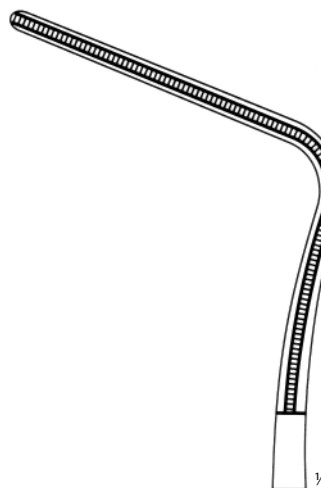

HARKEN

115 91 0688  
24,0 cm115 91 0689  
24,0 cm115 91 0690  
24,0 cm115 91 0691  
24,0 cm



DE BAKEY

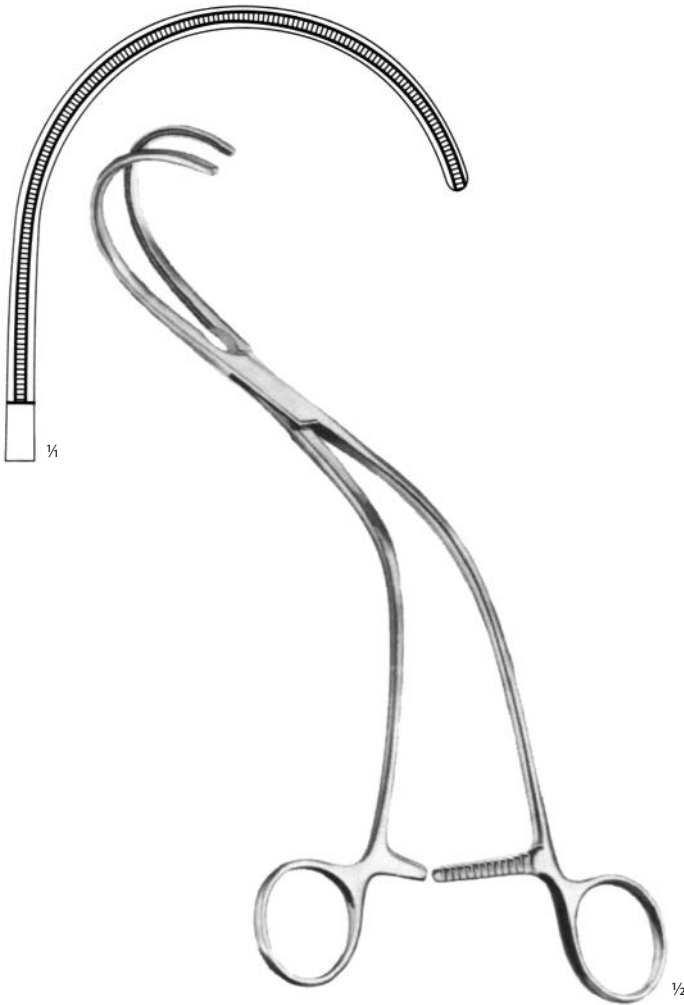

**WEBER**  
**115 91 0692**  
26,0 cm

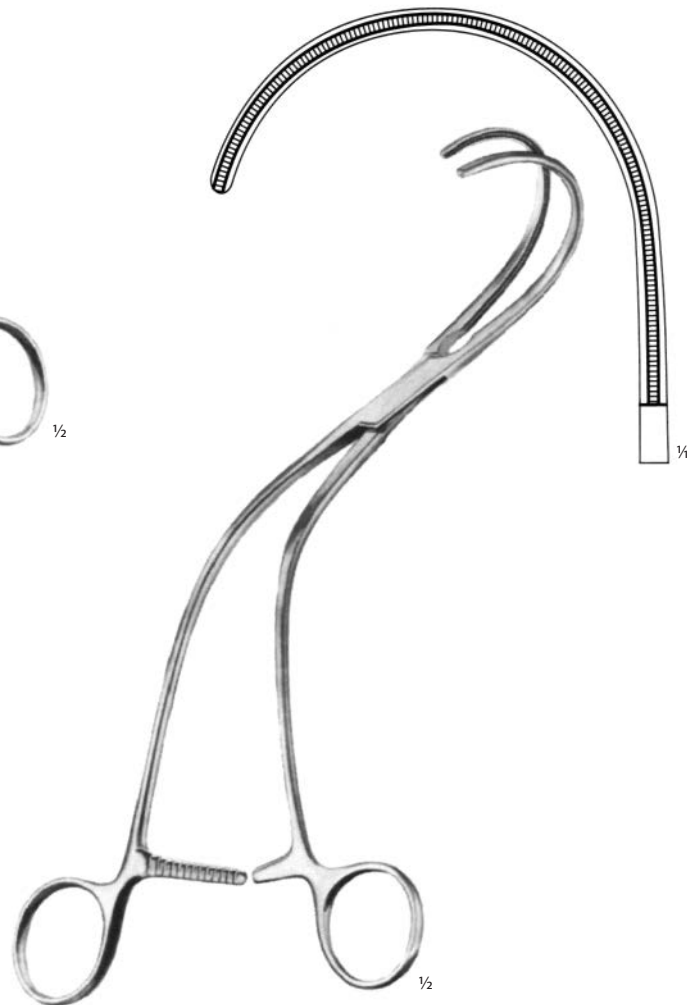

**WEBER**  
**115 91 0693**  
26,0 cm

SVORKY ATRAUMATICKÉ NA CÉVY  
ARTERY FORCEPS ATRAUMATIC JAWS

DE BAKEY

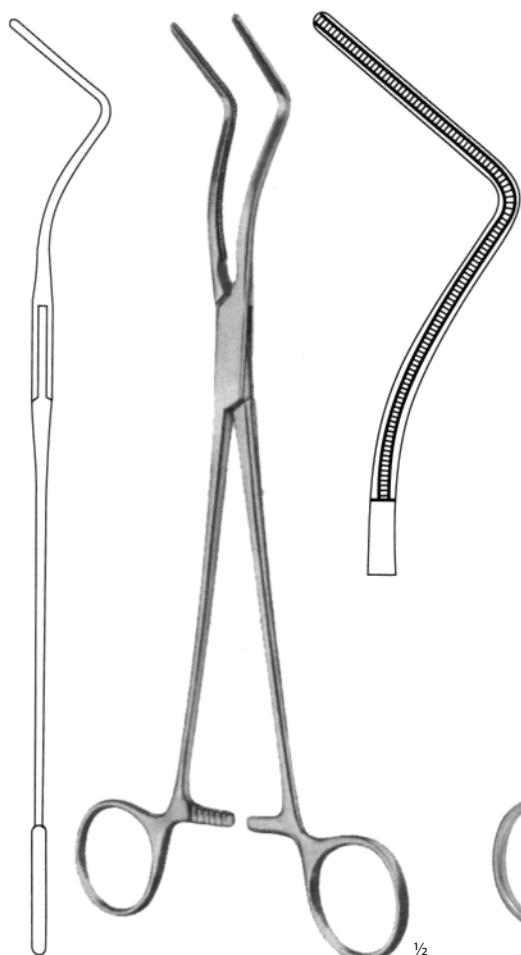
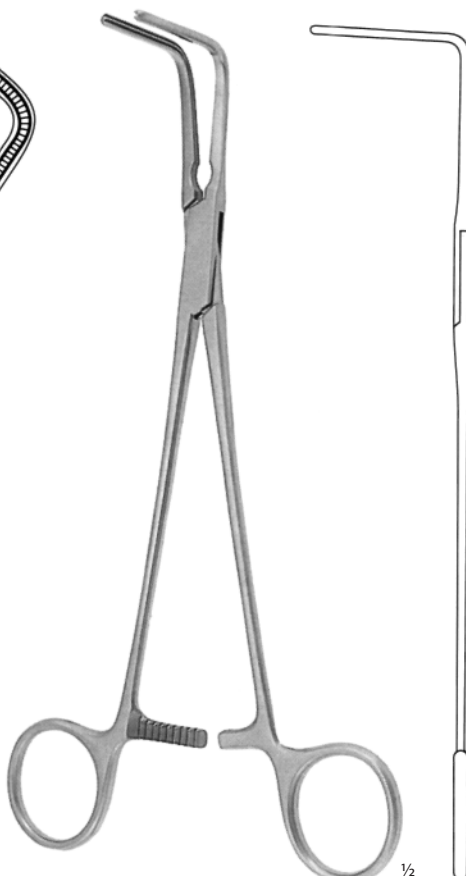
LEES  
115 91 0694  
25,0 cm

LEES

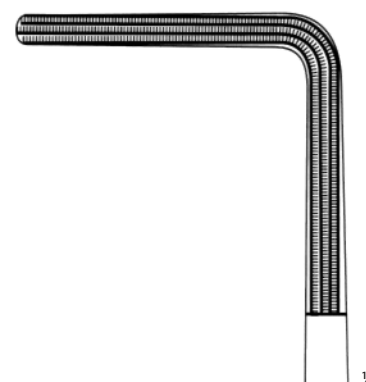
115 91 0599  
23,0 cm115 91 0695  
25,0 cm



DE BAKEY



**DE BAKEY**  
**115 91 0696**  
27,0 cm

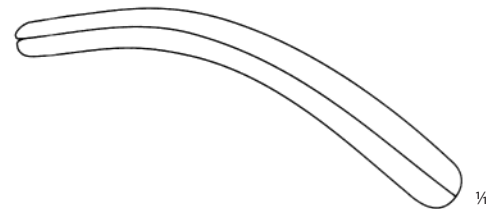
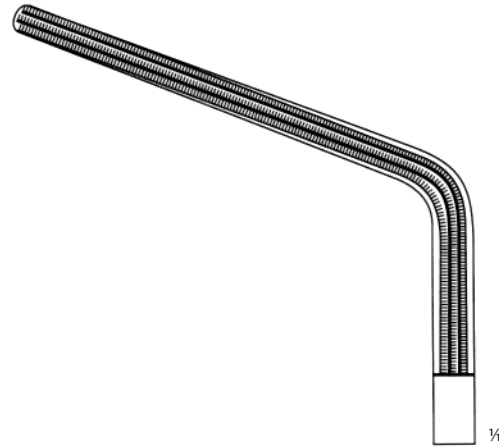

horní pohled  
top view



DE BAKEY

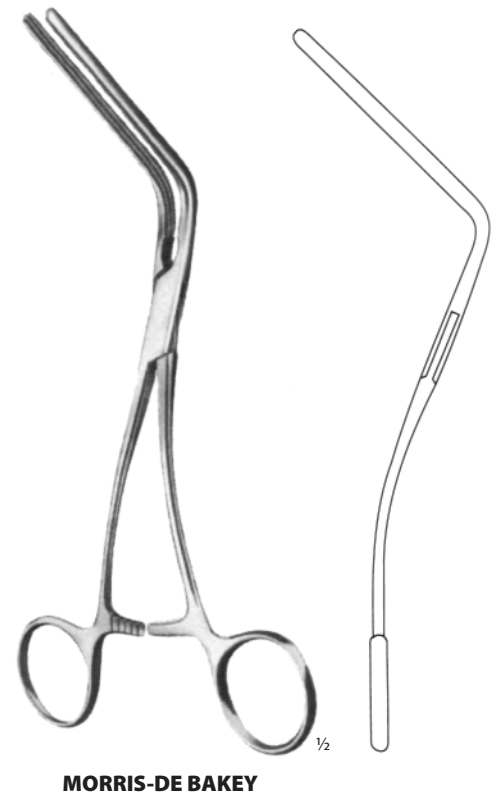
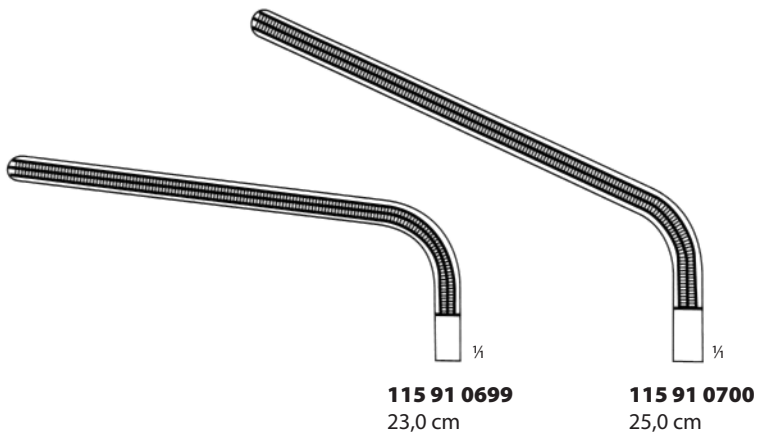
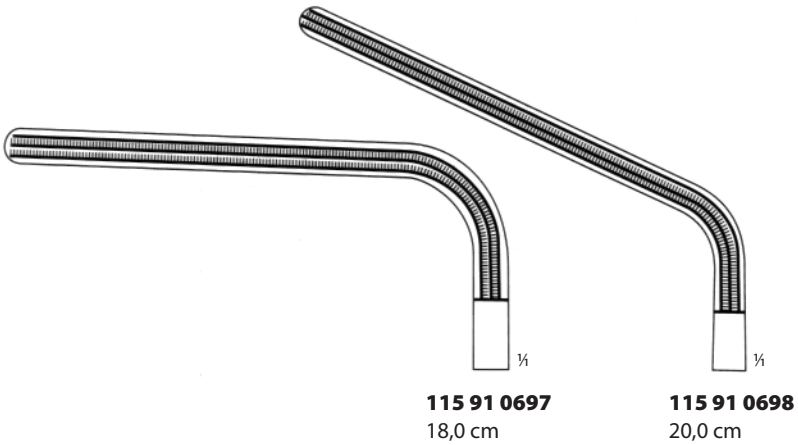



DE BAKEY



**OCHSNER**  
**115 91 0701**  
23,5 cm



**DIETRICH**  
**115 91 0702**  
21,0 cm



**GREGORY**

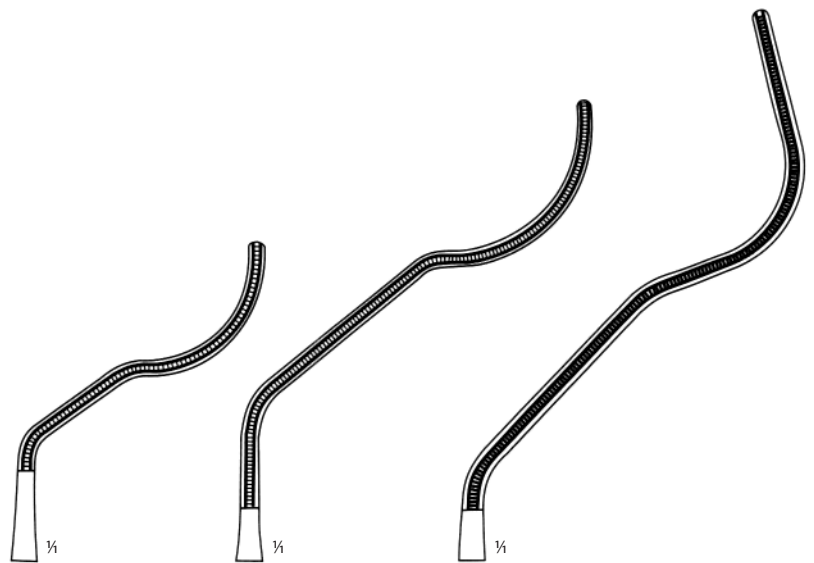

**115 91 0703**  
14,0 cm

**115 91 0704**  
16,0 cm

**115 91 0705**  
18,0 cm

SVORKY ATRAUMATICKÉ NA CÉVY  
ARTERY FORCEPS ATRAUMATIC JAWS



DE BAKEY



DALE

115 91 0706  
17,0 cm



115 91 0707  
18,0 cm



115 91 0708  
18,5 cm

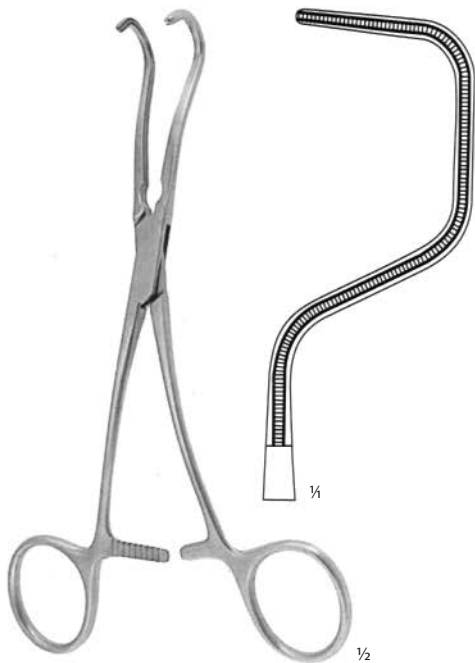

DALE  
115 91 0709  
18,5 cm



DERRA

115 91 0710  
16,0 cm



115 91 0711  
17,0 cm



115 91 0712  
18,0 cm

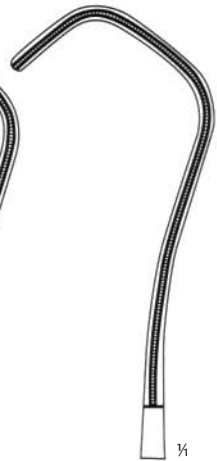





DE BAKEY

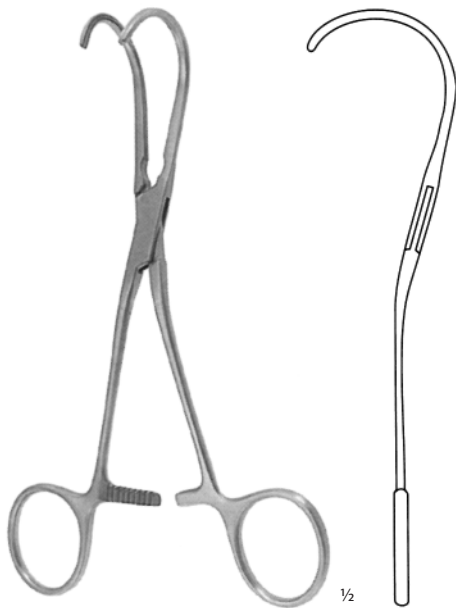

**115 91 0713**  
16,0 cm

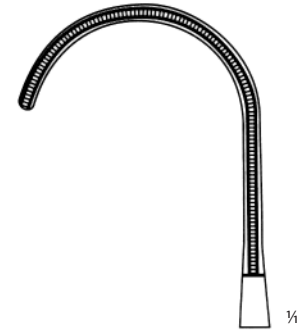

**115 91 0714**  
17,0 cm



**BECK**  
**115 91 0715**  
17,0 cm

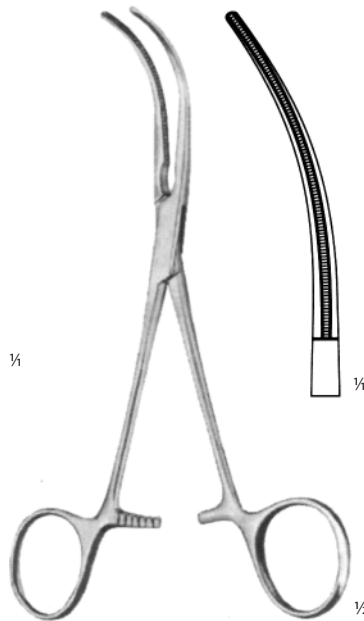

**GLOVER**  
**115 91 0716**  
17,0 cm

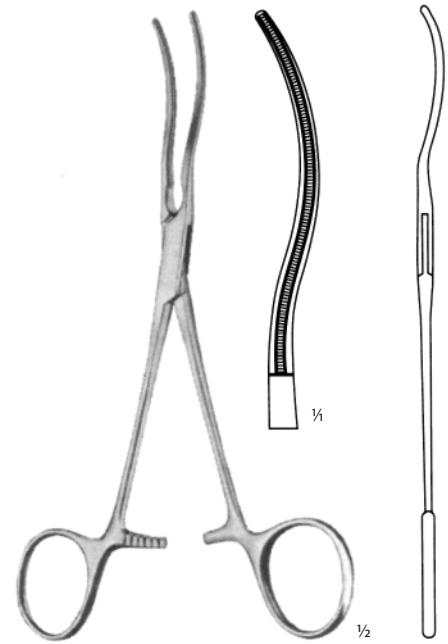

**GLOVER**  
**115 91 0717**  
17,0 cm

SVORKY ATRAUMATICKÉ NA CÉVY  
ARTERY FORCEPS ATRAUMATIC JAWS

DE BAKEY

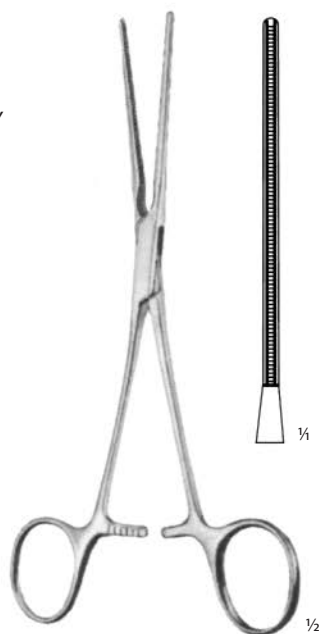

**DE BAKEY**  
**115 91 0718**  
17,0 cm

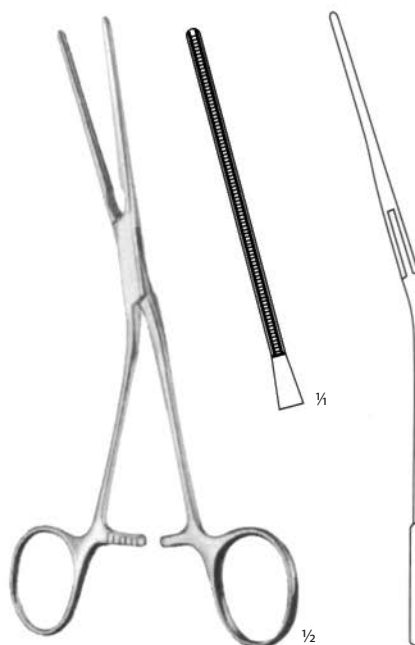

**DE BAKEY**  
**115 91 0719**  
17,0 cm

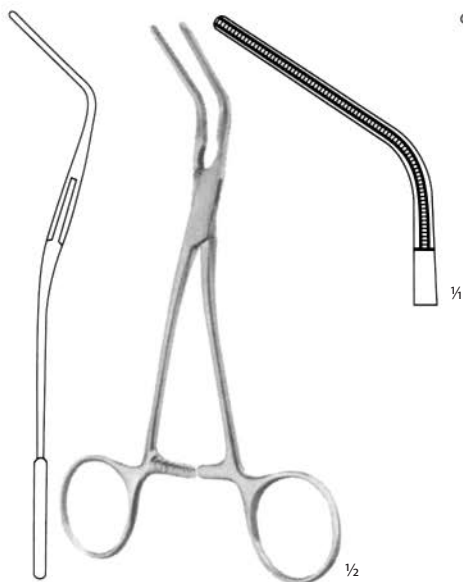

**DE BAKEY**  
**115 91 0720**  
15,0 cm

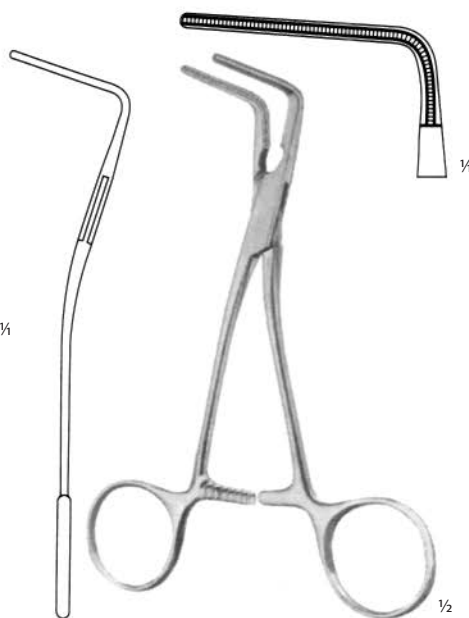

**DE BAKEY**  
**115 91 0721**  
15,0 cm

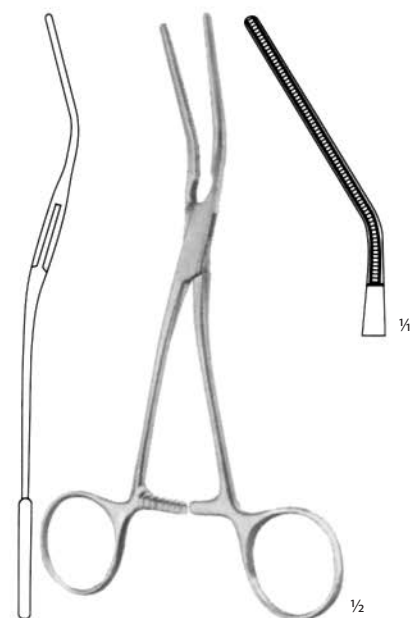

**DE BAKEY**  
**115 91 0722**  
16,0 cm

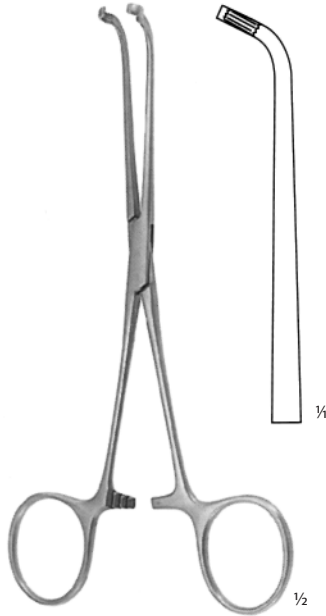

**JAVID**  
**115 91 0723**  
18,0 cm

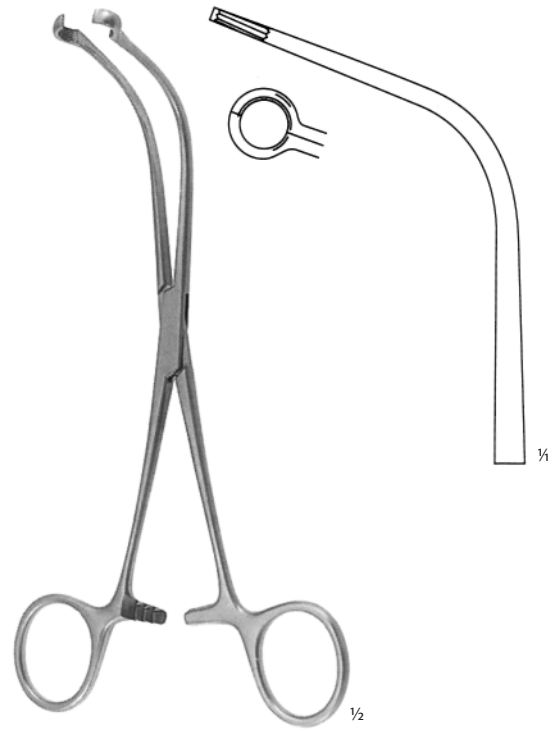

**JAVID**  
**115 91 0724**  
19,0 cm

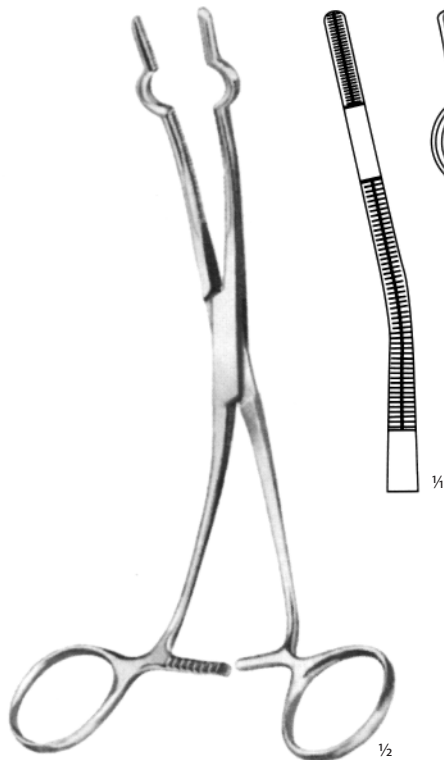

**COOLEY**

<b>115 91 0725</b>	16,0 cm	24 Ch
<b>115 91 0726</b>	16,0 cm	26 Ch
<b>115 91 0727</b>	20,0 cm	28 Ch
<b>115 91 0728</b>	20,0 cm	30 Ch
<b>115 91 0729</b>	20,0 cm	32 Ch
<b>115 91 0730</b>	20,0 cm	36 Ch



COOLEY

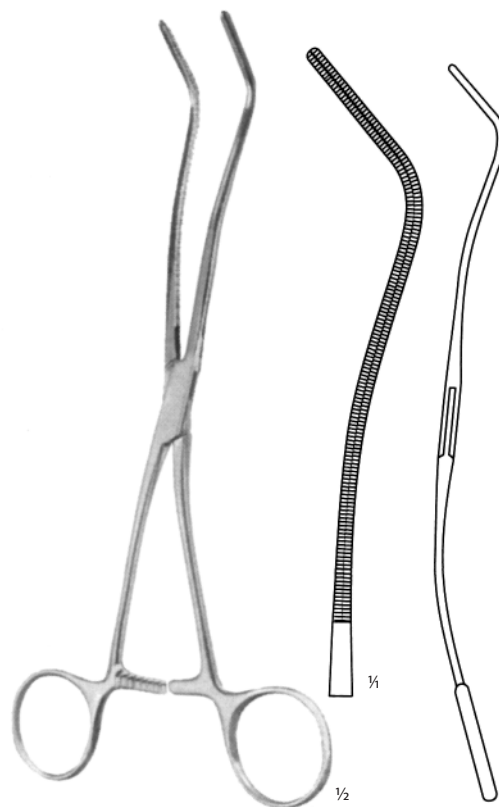

**COOLEY**  
**115 91 0731**  
20,0 cm

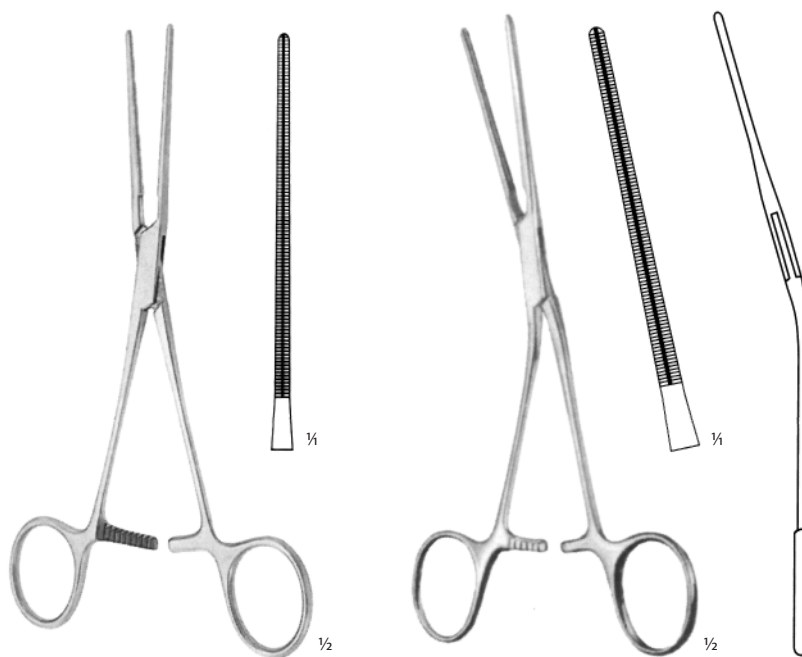

**COOLEY**  
**115 91 0732**  
17,0 cm

**COOLEY**  
**115 91 0733**  
17,0 cm



COOLEY



**COOLEY**  
**115 91 0734**  
17,0 cm

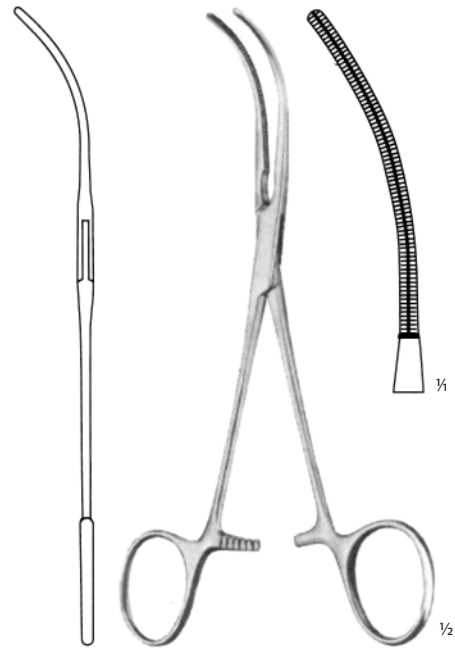

**COOLEY**  
**115 91 0735**  
17,0 cm

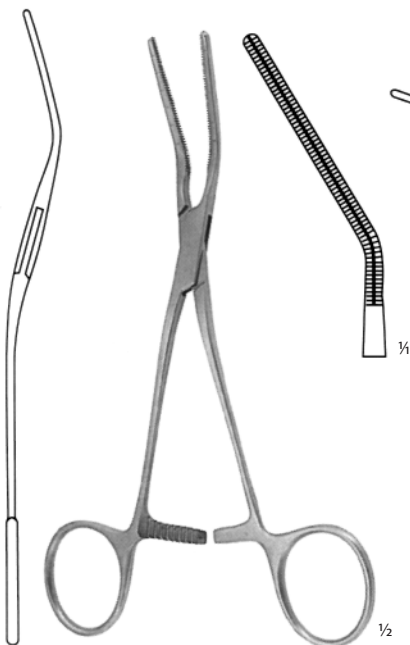

**COOLEY**  
**115 91 0736**  
17,0 cm

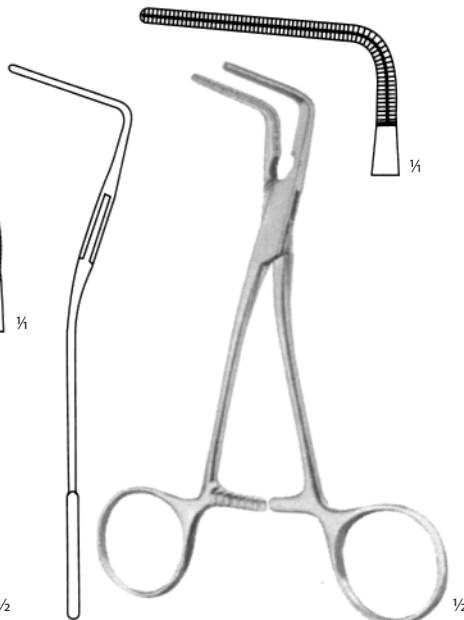

**COOLEY**  
**115 91 0737**  
15,0 cm

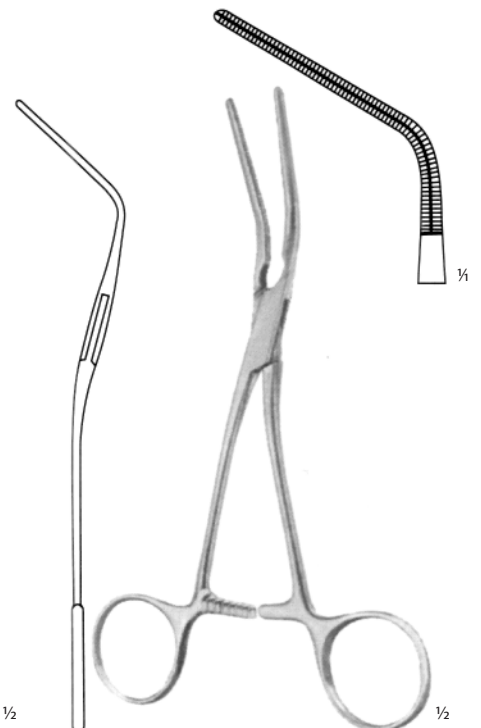

**COOLEY**  
**115 91 0738**  
15,5 cm



COOLEY



COOLEY

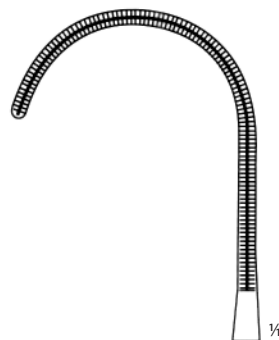

115 91 0739  
16,0 cm

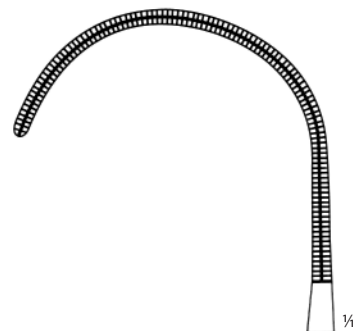

115 91 0740  
17,0 cm

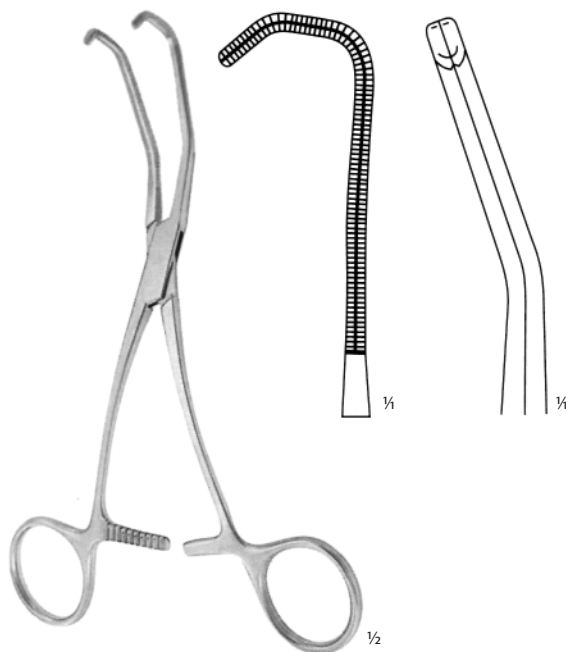

COOLEY  
115 91 0741  
17,0 cm

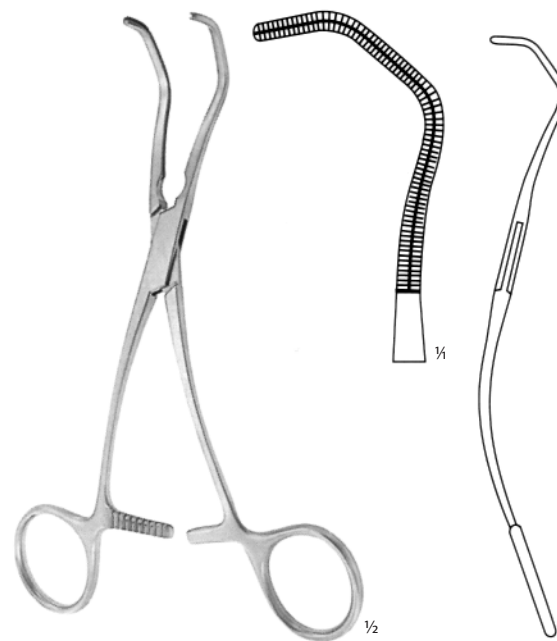

COOLEY  
115 91 0742  
16,0 cm



COOLEY

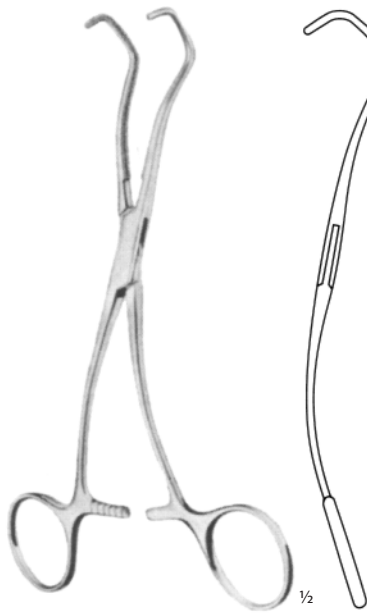

COOLEY-DERRA

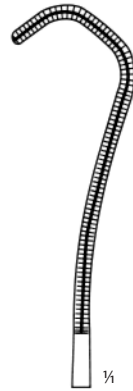

**115 91 0743**  
16,0 cm

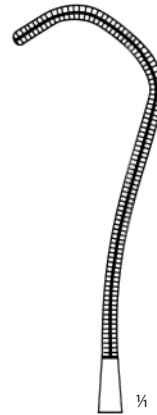

**115 91 0744**  
17,0 cm

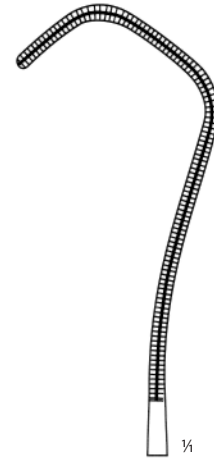

**115 91 0745**  
18,0 cm



**BECK**  
**115 91 0746**  
17,0 cm

SVORKY ATRAUMATICKÉ NA CÉVY  
ARTERY FORCEPS ATRAUMATIC JAWS

DARDIK

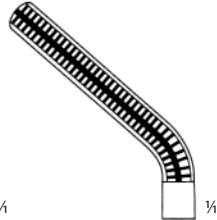
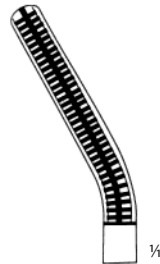
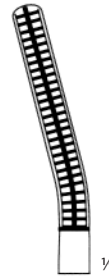
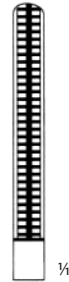
**115 91 0747**  
13,0 cm**115 91 0748**  
14,5 cm**115 91 0749**  
15,0 cm**115 91 0750**  
15,0 cm**115 91 0751**  
15,0 cm

DARDIK

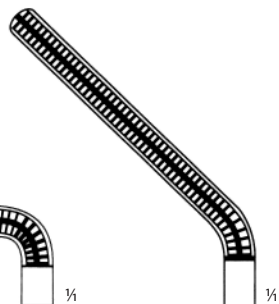
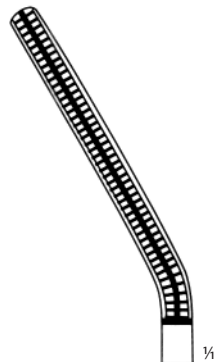
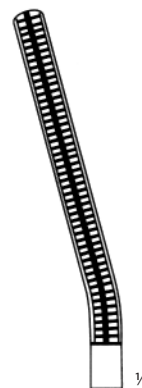
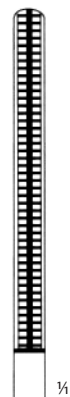
**115 91 0752**  
13,5 cm**115 91 0753**  
16,0 cm**115 91 0754**  
17,0 cm**115 91 0755**  
17,0 cm**115 91 0756**  
17,0 cm





COOLEY

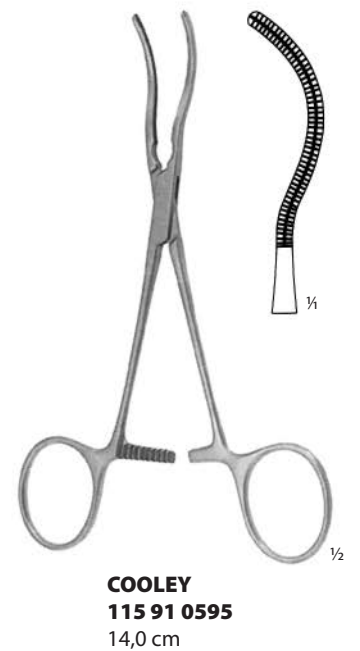
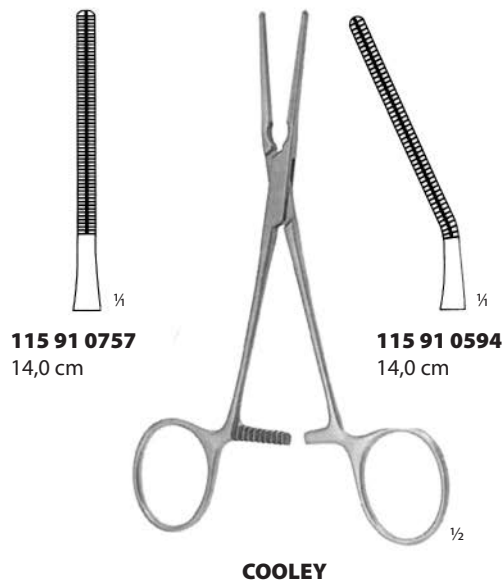

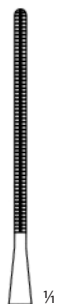
SVORKY ATRAUMATICKÉ NA CÉVY  
ARTERY FORCEPS ATRAUMATIC JAWS

**115 91 0760**  
14,0 cm

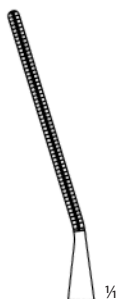

**115 91 0761**  
14,0 cm

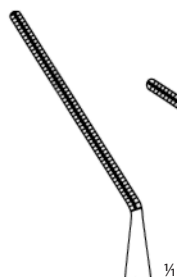

**115 91 0762**  
14,0 cm

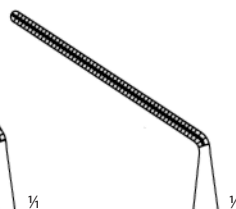

**115 91 0763**  
13,0 cm



**115 91 0764**  
14,0 cm

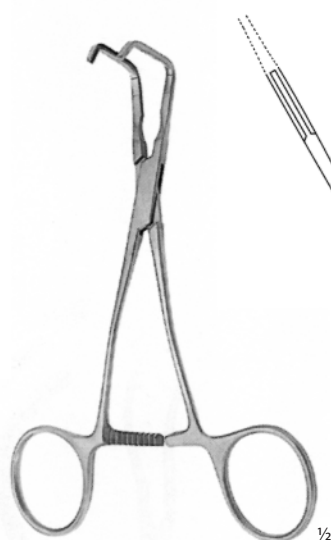

**115 91 0765**  
13,0 cm

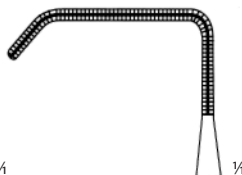

**115 91 0766**  
13,0 cm



**115 91 0767**  
14,0 cm

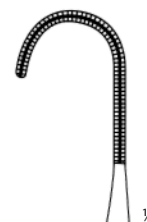

**115 91 0768**  
13,5 cm

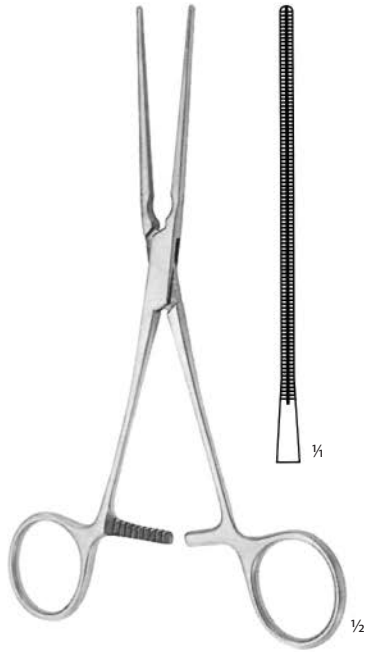

**115 91 0769**  
16,5 cm



**115 91 0770**  
16,0 cm

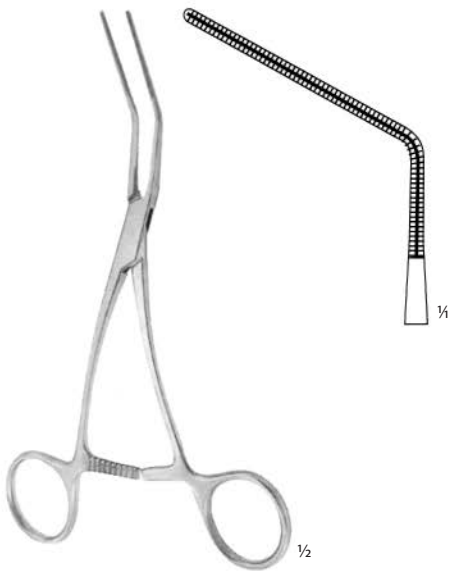

**115 91 0771**  
15,0 cm

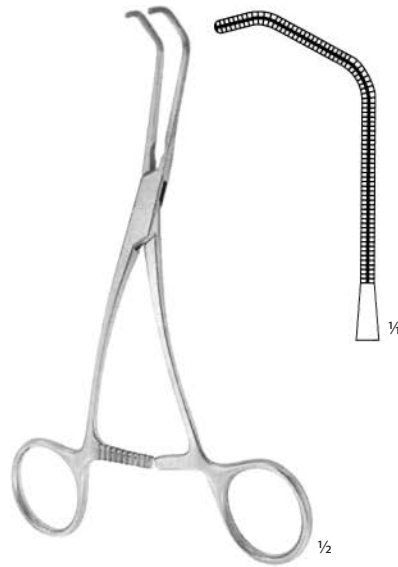

**115 91 0772**  
15,0 cm

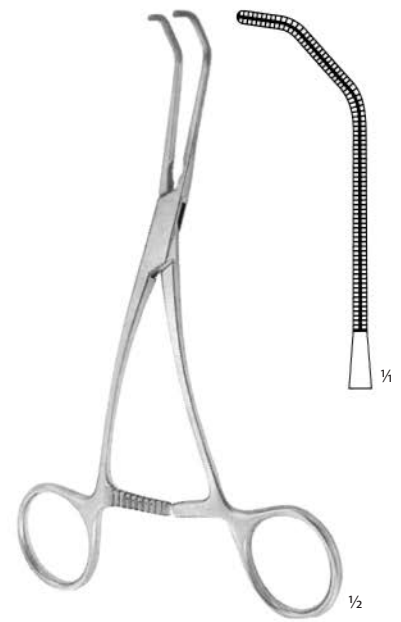

**115 91 0773**  
15,5 cm

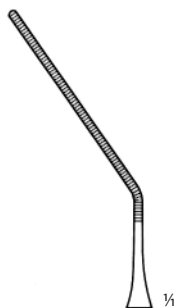
SVORKY ATRAUMATICKÉ NA CÉVY  
ARTERY FORCEPS ATRAUMATIC JAWS

**115 91 0774**  
13,0 cm

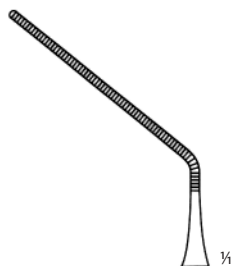

**115 91 0775**  
13,0 cm



**115 91 0776**  
11,0 cm



**CASTANEDA**

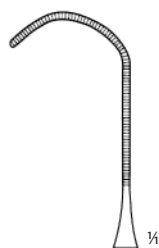

**115 91 0777**  
12,0 cm

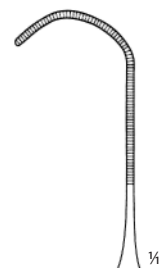

**115 91 0778**  
12,0 cm

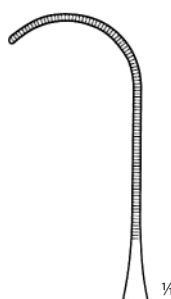

**115 91 0779**  
12,0 cm

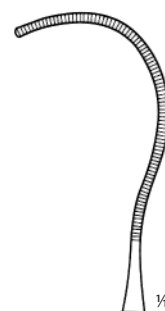

**115 91 0780**  
12,0 cm

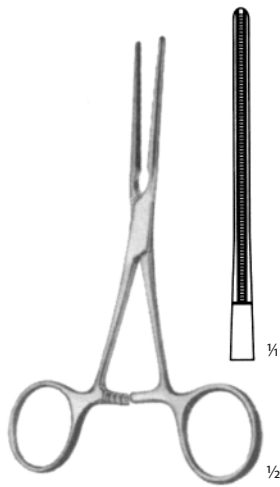

**DE BAKEY**  
**115 91 0781**  
12,0 cm

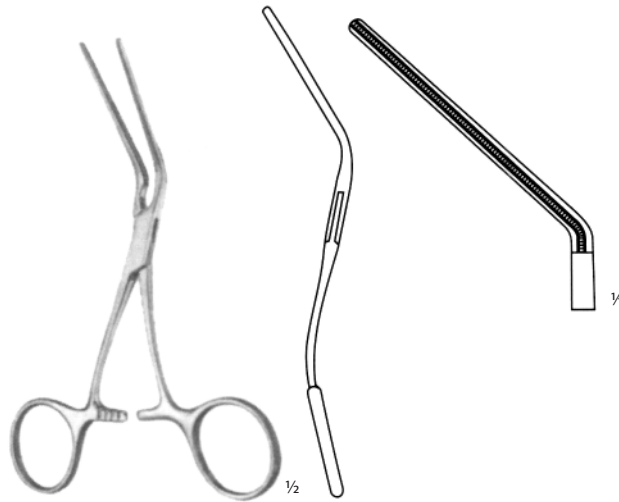

**DE BAKEY**  
**115 91 0782**  
13,0 cm

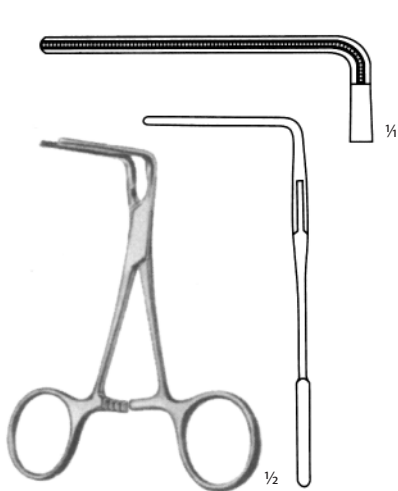

**DE BAKEY**  
**115 91 0783**  
10,0 cm

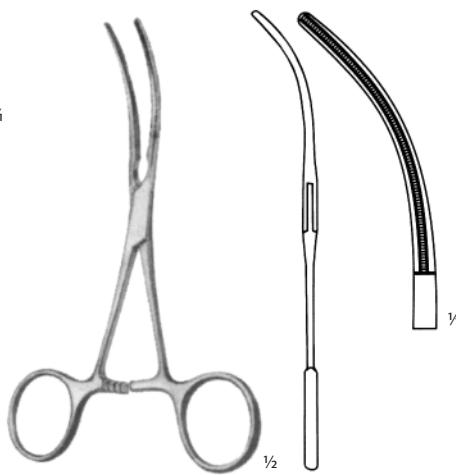

**DE BAKEY**  
**115 91 0784**  
11,0 cm



**DE BAKEY**  
**115 91 0785**  
12,0 cm

SVORKY ATRAUMATICKÉ NA CÉVY  
ARTERY FORCEPS ATRAUMATIC JAWS

DE BAKEY

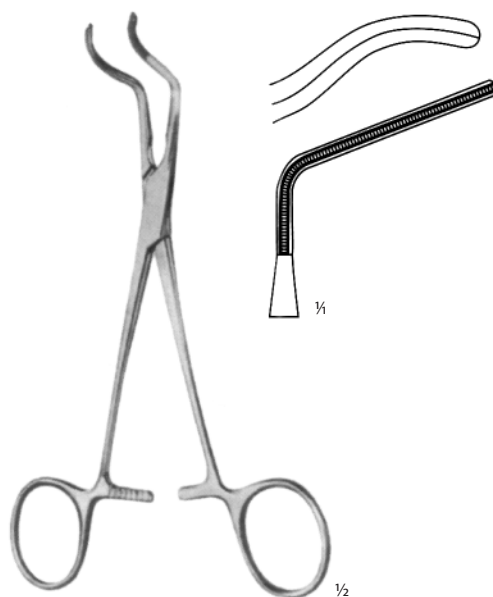

**SUBRAMANIAN-MINIATURE**  
115 91 0786  
15,5 cm

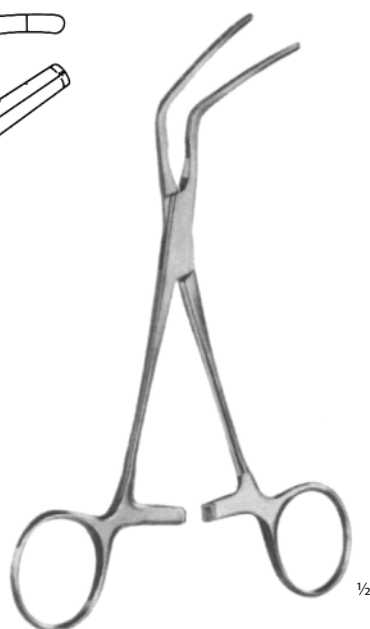
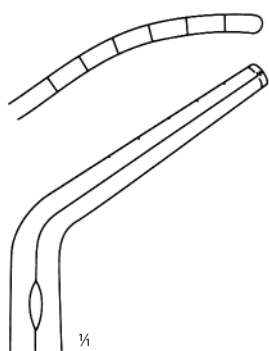

**SUBRAMANIAN**  
115 91 0787  
16,0 cm

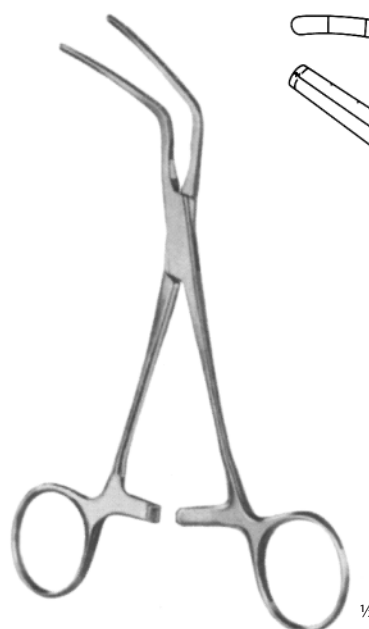
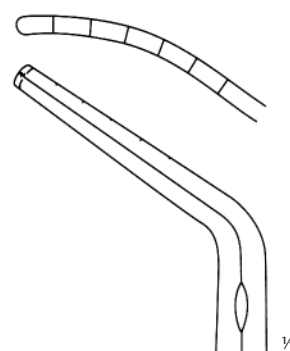

**SUBRAMANIAN**  
115 91 0788  
16,0 cm



**SATINSKY**  
26,0 cm

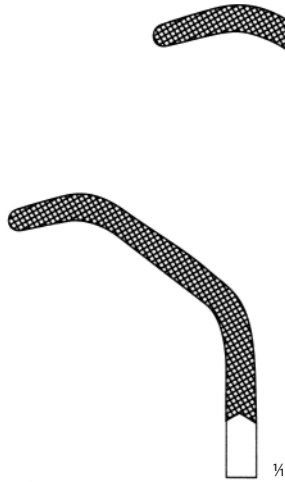

**115 91 0796**

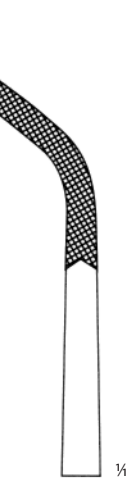

**115 91 0797**

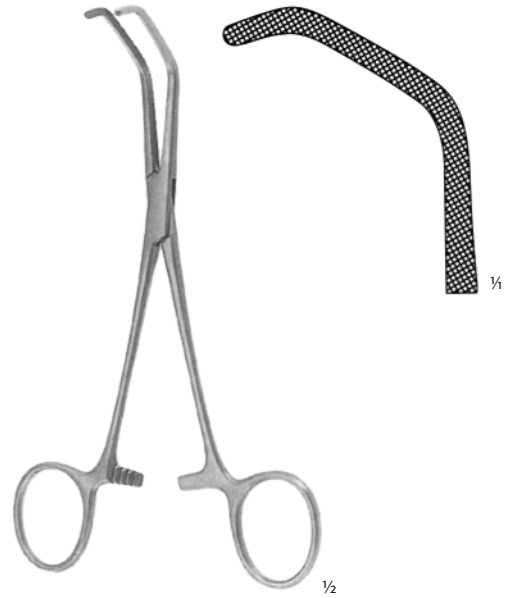

**BABY-SATINSKY**  
**115 91 0798**  
15,0 cm



**HARKEN**  
24,0 cm



**115 91 0799**  
24,0 cm



**115 91 0800**  
24,0 cm

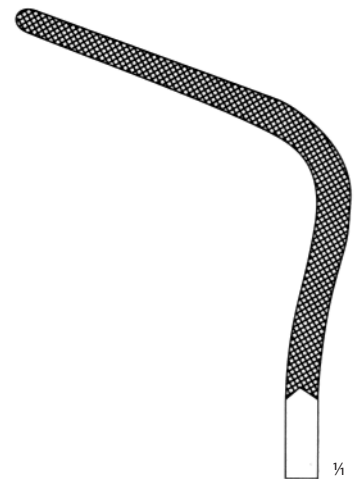

**115 91 0801**  
24,0 cm

SVORKY NA PRÁDLO  
TOWEL FORCEPS

**SCHAEDEL**  
**115 91 0332**  
9,0 cm



**JONES**  
**115 91 0333** 5,0 cm  
**115 91 0334** 9,0 cm



**ENGL. MODELL**  
**115 91 0335**  
9,0 cm



**DOYEN**  
**115 91 0336**  
18,0 cm



**BERNHARD**  
**115 91 0337**  
16,5 cm



**LANE**  
**115 91 0338** 15,0 cm  
**115 91 0339** 18,0 cm  
**115 91 0340** 20,0 cm

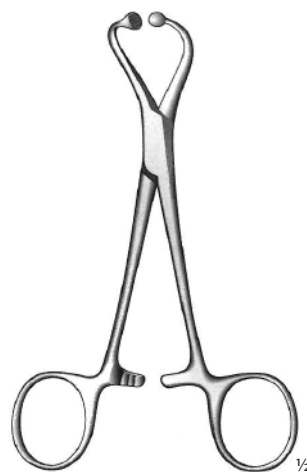

**BACKHAUS**  
**115 08 0780**  
11,0 cm



**BACKHAUS**  
**115 08 0790**  
12,0 cm



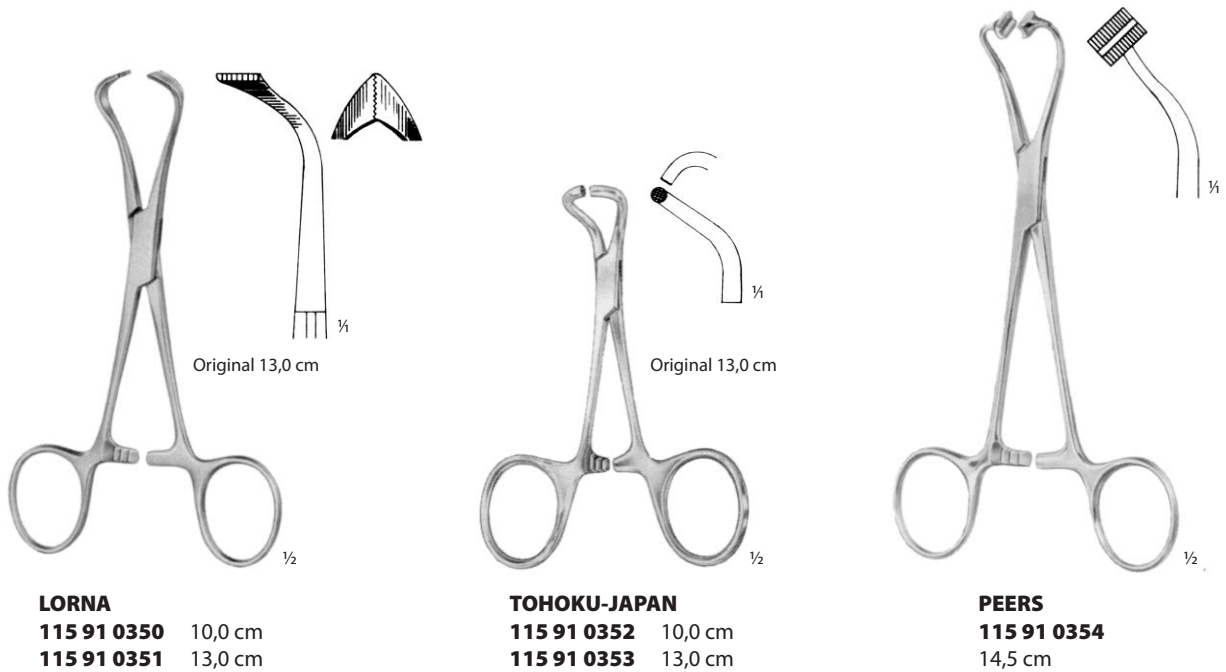
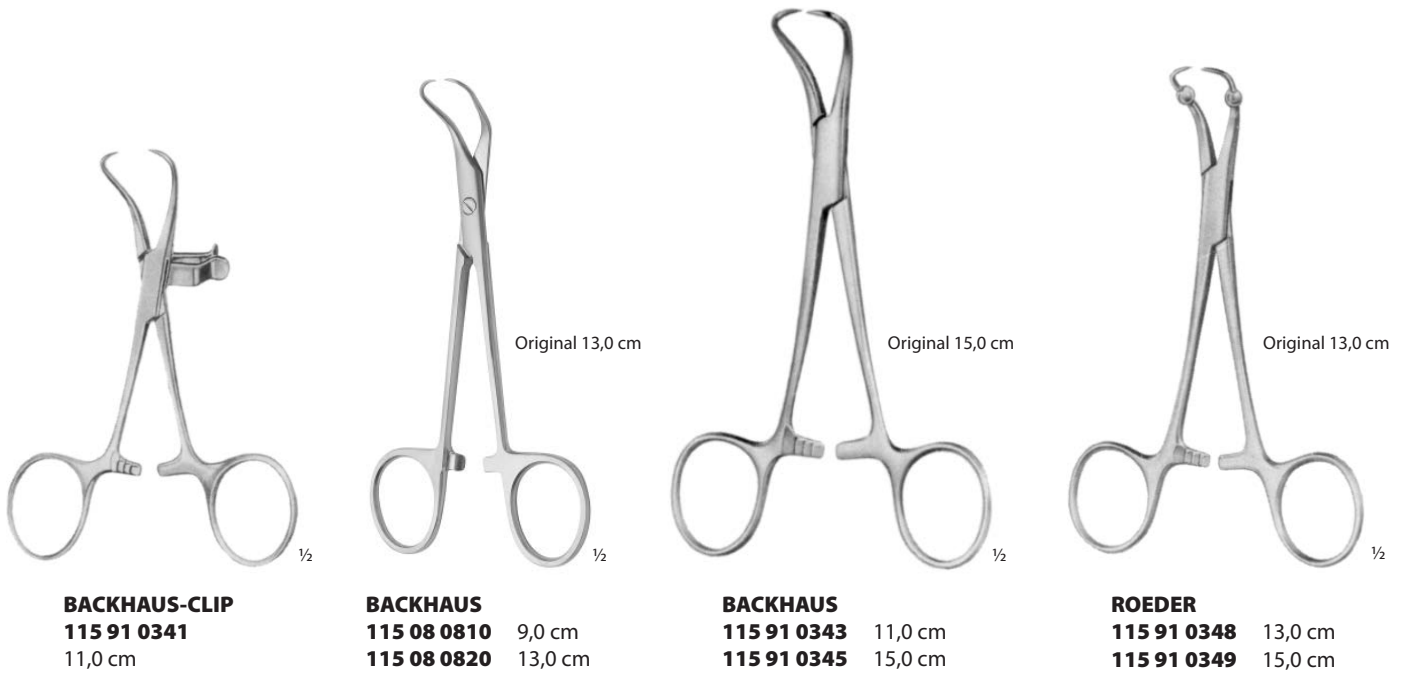

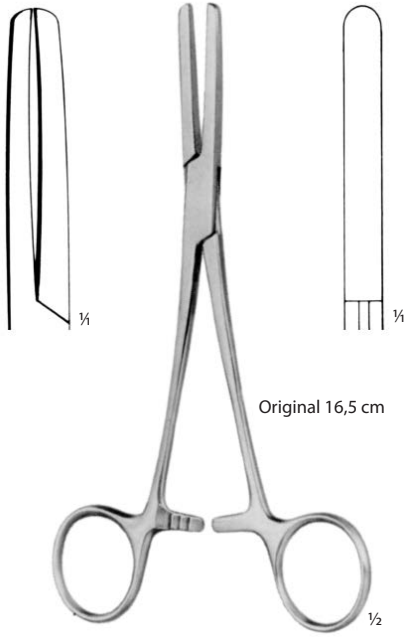

**PRESBYTERIAN**  
115 91 0355 16,5 cm  
115 91 0356 18,0 cm



**KLINIKUM BERLIN**  
115 91 0357  
14,5 cm

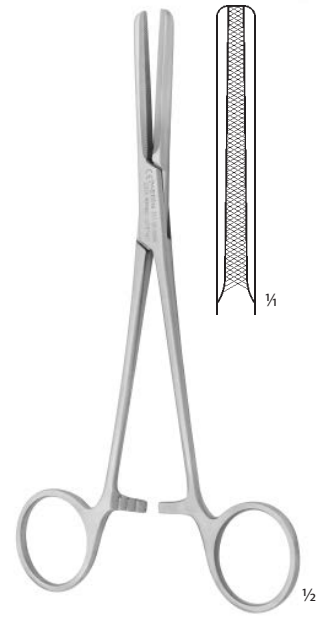

**117 07 0040**  
15,0 cm

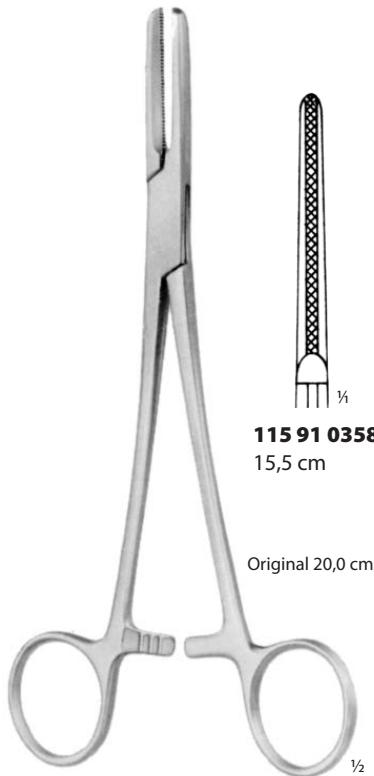

**115 91 0358**  
15,5 cm

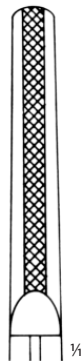

**115 91 0359**  
18,0 cm

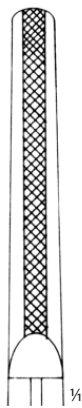

**115 91 0360**  
20,0 cm

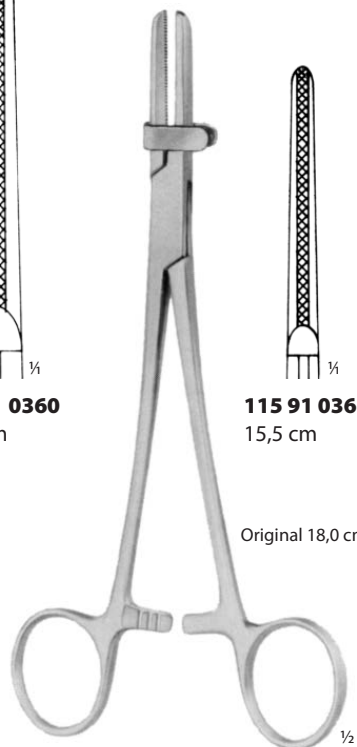

**115 91 0361**  
15,5 cm

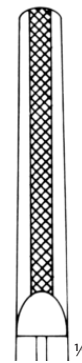

**115 91 0362**  
18,0 cm

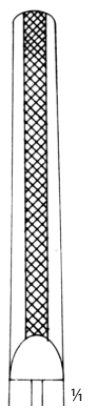

**115 91 0363**  
20,0 cm

# 116

## KLEŠTĚ ŠTÍPACÍ BONE RONGEURS





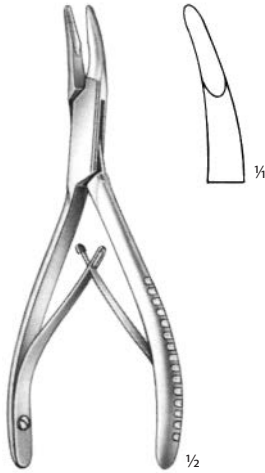

**MINI-FRIEDMAN**  
**116 91 0017**  
12,0 cm



**FRIEDMAN**  
**116 91 0514**  
14,0 cm

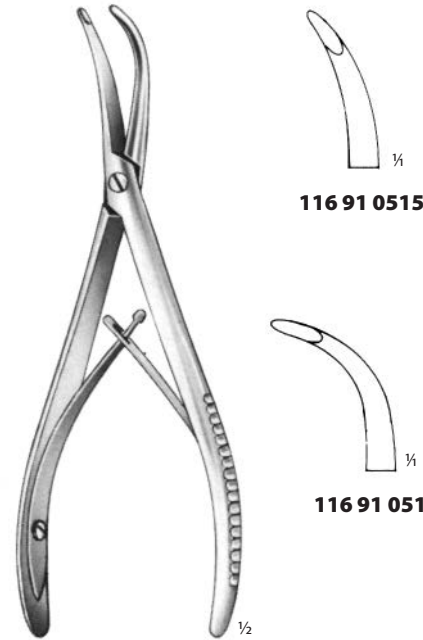

**STELLBRINK**  
17,0 cm

**116 91 0515**

**116 91 0516**

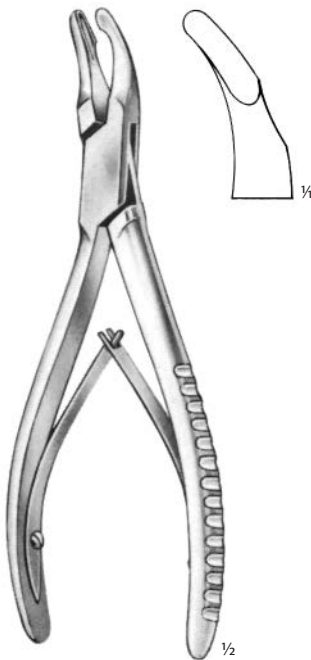

**CLEVELAND**  
**116 91 0518**  
17,0 cm



**BLUMENTHAL**  
15,5 cm

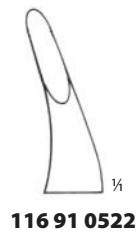

**116 91 0522**

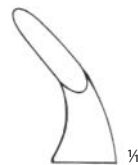

**116 91 0523**

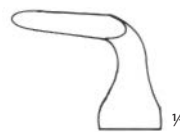

**116 91 0524**

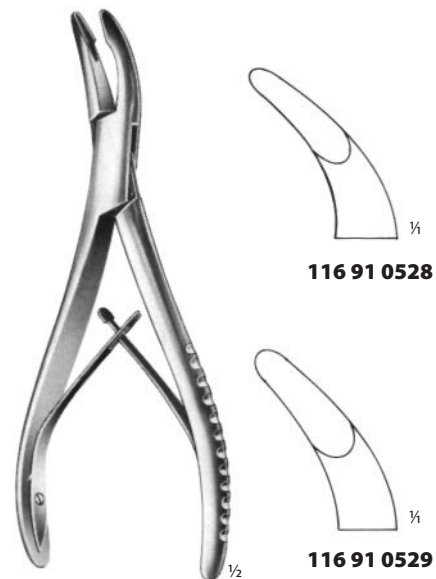

**LUER**  
15,0 cm

**116 91 0527**

**116 91 0528**

**116 91 0529**



**116 08 0030**  
rovné  
straight

**LUER**  
17,0 cm

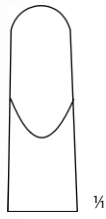

**116 08 0040**  
zahnuté  
curved



**116 08 0070**  
zahnuté  
curved

**LUER**  
15,0 cm

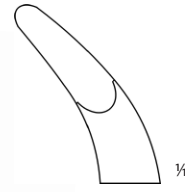

**116 08 0080**  
zahnuté  
curved

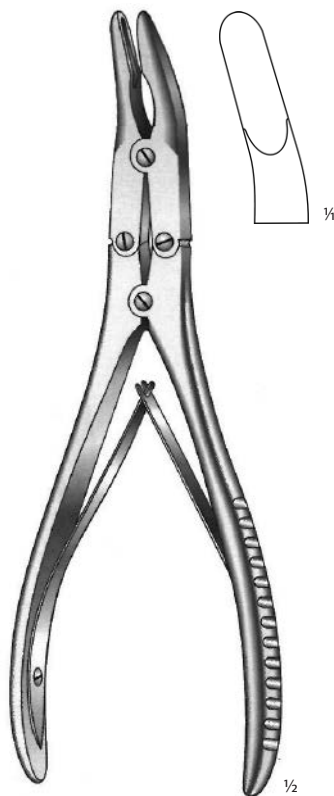

**RUSKIN**  
**116 08 0090**  
zahnuté  
curved  
20,0 cm

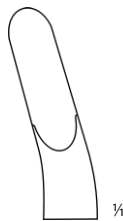

**LUER**  
**116 08 0130**  
lomené  
angled  
24,0 cm





**LUER**  
**116 08 0140**  
zahnuté  
curved  
27,0 cm



**LUER**  
**116 08 0150**  
mírně lomené  
light angled  
24,0 cm

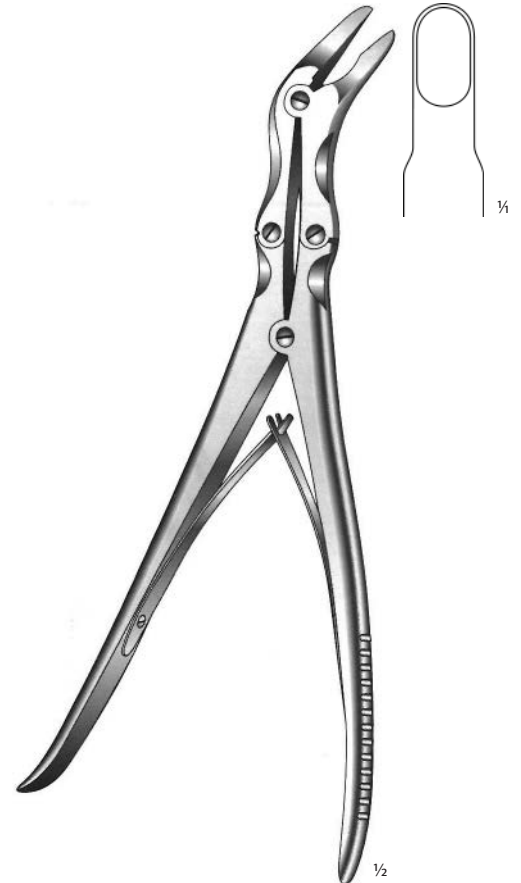

**LUER**  
**116 08 0160**  
lomené  
angled  
23,0 cm

KLEŠTĚ ŠTÍPACÍ  
BONE RONGEURS

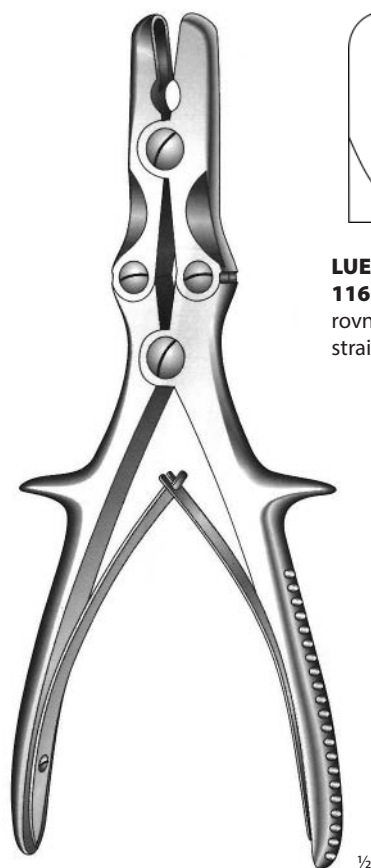

22,0 cm

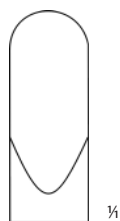

**LUER**  
**116 08 0180**  
rovné  
straight

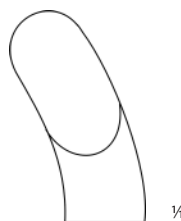

**LUER-STILLE**  
**116 08 0190**  
zahnuté  
curved



**MARQUARDT**  
**116 91 0258**  
20,0 cm



**MAYFIELD**  
**116 91 0259**  
17,0 cm



**BÖHLER**  
15,0 cm



**116 91 0260**

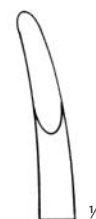

**116 91 0261**

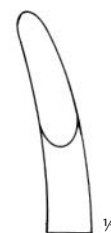

**116 91 0262**



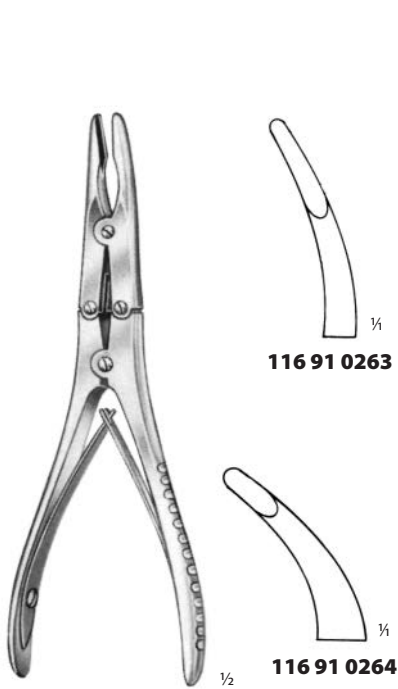

**KEINERT-KUTZ**  
15,0 cm



**BEYER**  
**116 91 0266**  
18,0 cm

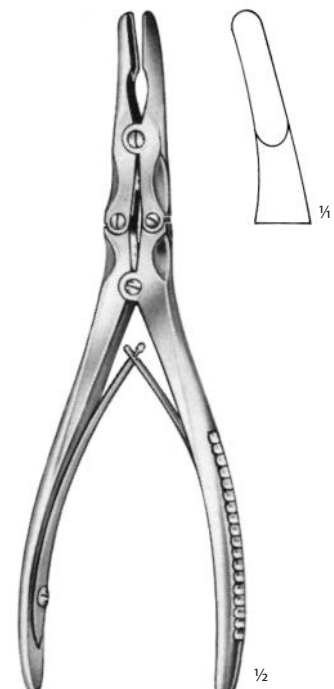

**ZAUFAL-JANSEN**  
**116 91 0267**  
18,0 cm



**ECHLIN**  
23,0 cm

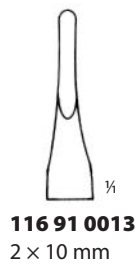

**116 91 0013**  
2 x 10 mm



**116 91 0014**  
3 x 10 mm



**116 91 0015**  
4 x 10 mm



**STILLE-RUSKIN**  
**116 91 0271**  
23,0 cm



**RUSKIN**  
**116 91 0280**  
23,0 cm



**SMITH-PETERSON**  
24,0 cm



**116 91 0281**  
3,0 mm



**116 91 0282**  
4,0 mm

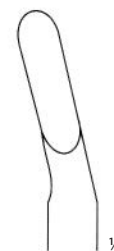

**116 91 0283**  
5,0 mm

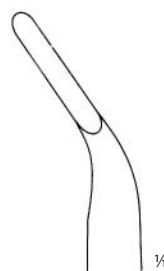

**116 91 0284**  
3,0 mm

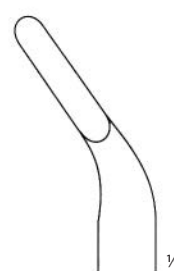

**116 91 0285**  
4,0 mm

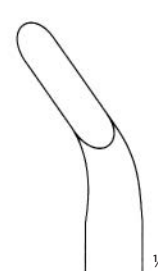

**116 91 0286**  
5,0 mm



**LISTON**



**116 08 0410**  
rovné  
straight  
14,0 cm



**116 08 0440**  
rovné  
straight  
19,0 cm



**116 08 0450**  
zahnuté  
curved  
19,0 cm



**LISTON**  
17,0 cm

Original 17 cm



**116 91 0291**  
17,0 cm



**116 91 0294**  
14,0 cm



**116 91 0295**  
17,0 cm



**116 91 0293**  
22,0 cm



**116 91 0297**  
22,0 cm

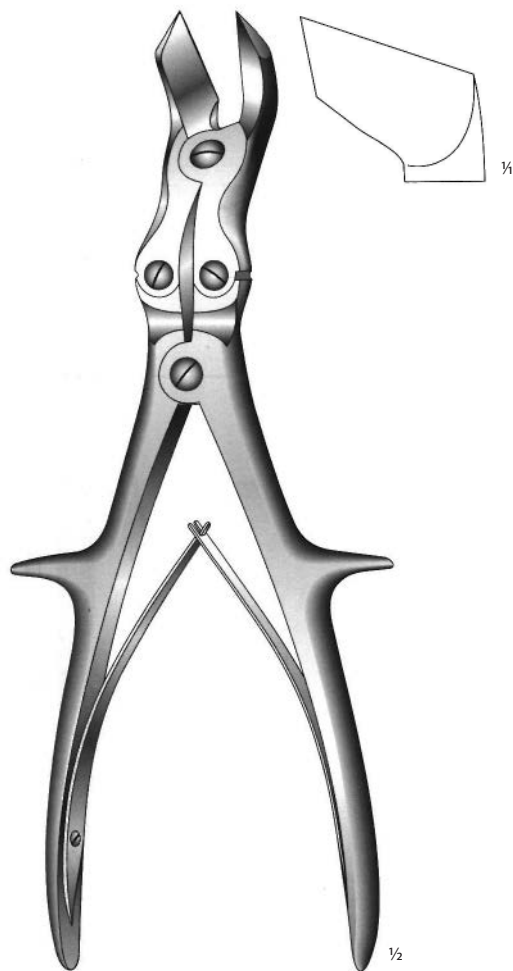

**LISTON**  
**116 08 0470**  
dvojitě zahnuté  
double curved  
27,0 cm

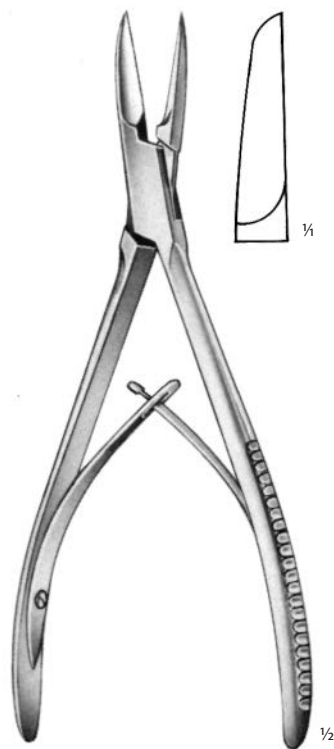

**COTTLE KAZANJIAN**  
**116 91 0287**  
19,0 cm

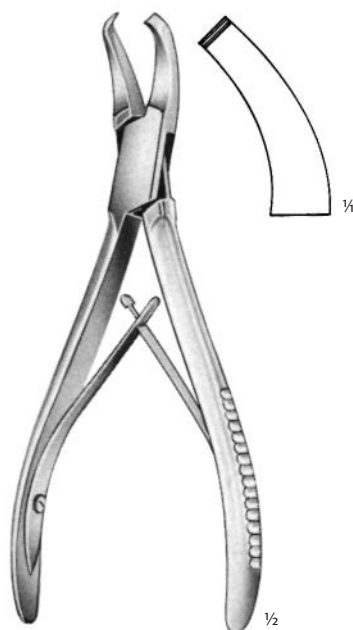

**CLEVELAND-GARDNER**  
**116 91 0288**  
16,0 cm



**MARKWALDER**  
**116 91 0289**  
20,0 cm



**LITTAUER-LISTON**  
**116 91 0298**  
15,0 cm

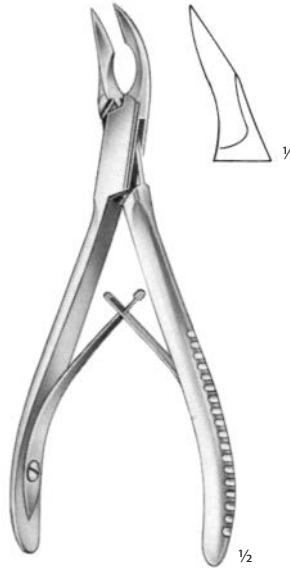

**CLEVELAND**  
**116 91 0299**  
15,0 cm

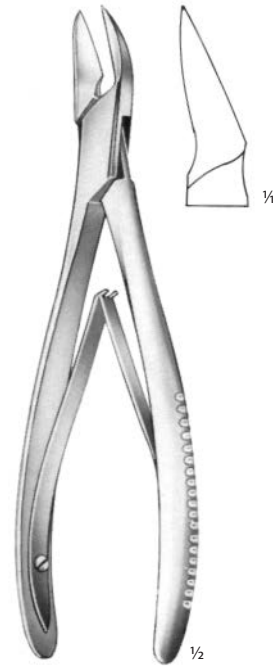

**CLEVELAND**  
**116 91 0300**  
17,0 cm



**116 91 0301**  
12,0 cm



**WALTON-LISTON**  
**116 91 0305**  
15,0 cm



**116 91 0548**  
22,0 cm



**GLUCK**  
**116 91 0140**  
22,0 cm



**BETHUNE**  
**116 91 0549**  
34,0 cm



**SAUERBRUCH**  
**116 91 0550**  
26,0 cm



**CORYLLOS**  
**116 91 0551**  
35,0 cm



**CORYLLOS**  
**116 91 0552**  
35,0 cm



**GIERTZ-STILLE**  
**116 91 0256**  
27,0 cm



**SAUERBRUCH-FREY**  
**116 91 0553**  
36,0 cm



**BRUNNER**  
32,0 cm



**116 91 0555**  
32,0 cm



**116 91 0556**  
32,0 cm

KLEŠTĚ ŠTÍPACÍ NA DRÁT  
WIRE CUTTING FORCEPS**116 91 0001**

14,5 cm

pro měkký drát do  $\varnothing$  1,5 mm  
pro tvrdý drát do  $\varnothing$  1.0 mmfor soft wires up to  $\varnothing$  1,5 mm  
for hard wires up to  $\varnothing$  1.0 mm**116 91 0004**

18,0 cm

pro měkký drát do  $\varnothing$  2,0 mm  
for soft wires up to  $\varnothing$  2.0 mm**116 91 0005**

17,0 cm

pro tvrdý drát do  $\varnothing$  1,5 mm  
for hard wires up to  $\varnothing$  1.5 mm**116 91 0006**

22,0 cm

do  $\varnothing$  2,5 mm  
for wires up to  $\varnothing$  2.5 mm





**116 91 0010**  
21,5 cm  
pro tvrdý drát do průměru 2,5 mm  
for hard wires up to diameter 2,5 mm



**116 91 0011**  
23,0 cm  
pro tvrdý drát do průměru 2,2 mm  
for hard wires up to diameter 2,2 mm

KLEŠTĚ ŠTÍPACÍ NA DRÁT  
WIRE CUTTING FORCEPS

Sada gumových čelistí pro 116 91 0008, 0539  
Set of rubber jaws for 116 91 0008, 0539  
**116 91 0540**

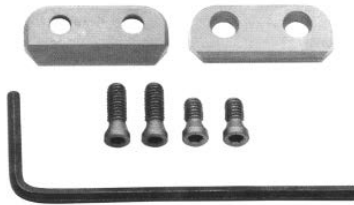

Sada čelistí pro 116 91 0008  
Set of jaws for 116 91 0008  
**116 91 0009**

Sada čelistí pro 116 91 0539  
Set of jaws for 116 91 0539  
**116 91 0541**



**HERCULES**  
**116 91 0008**  
28,0 cm  
do ø 3,5 mm  
for wires up to ø 3.5 mm



**HERCULES**  
**116 91 0539**  
23,0 cm  
do ø 3,0 mm  
for wires up to ø 3.0 mm

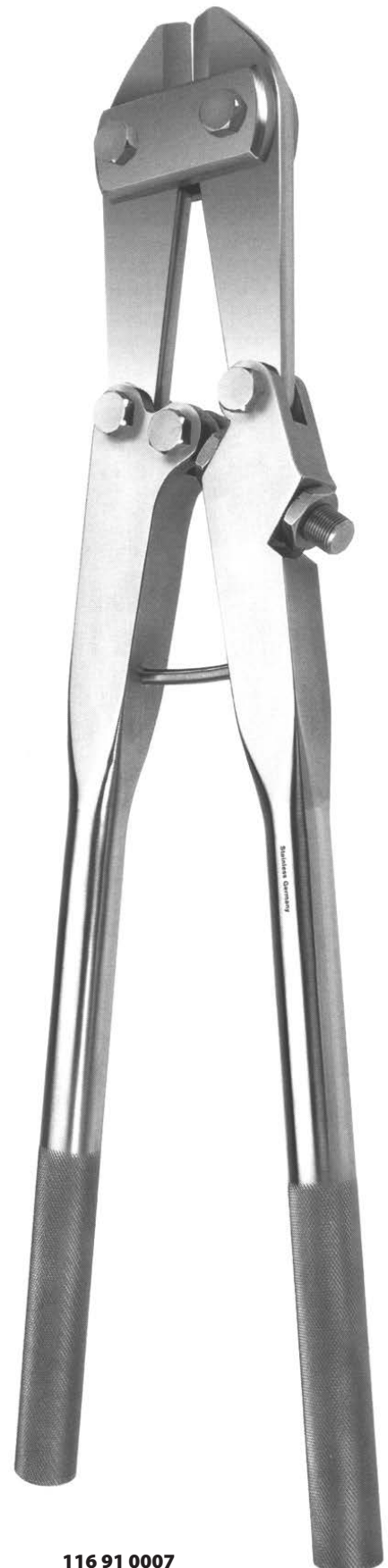

**116 91 0007**  
47,0 cm  
pro dráty, šrouby a hřeby do ø 6,0 mm  
for wires, screws and nails up to ø 6.0 mm

# 117

## KLEŠTĚ ÚCHOPNÉ GRASPING FORCEPS

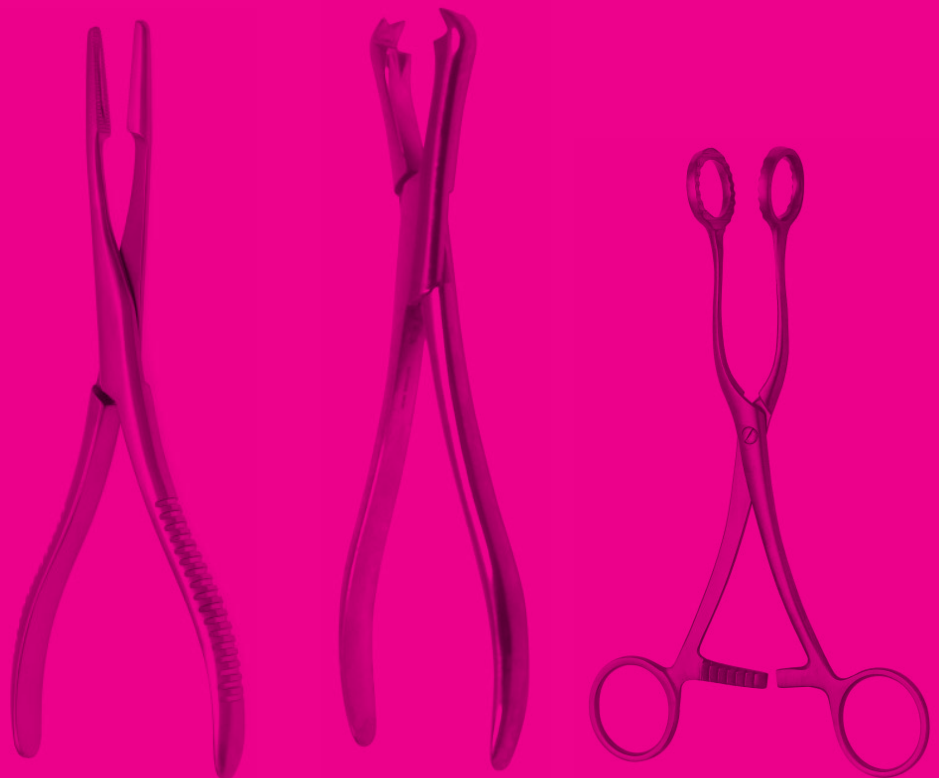





**HENNING**  
**117 91 0063**  
28,0 cm



**WOLFF**  
**117 91 0066** 18,0 cm  
**117 91 0067** 24,0 cm



**BEESON**  
**117 91 0064**  
30,0 cm

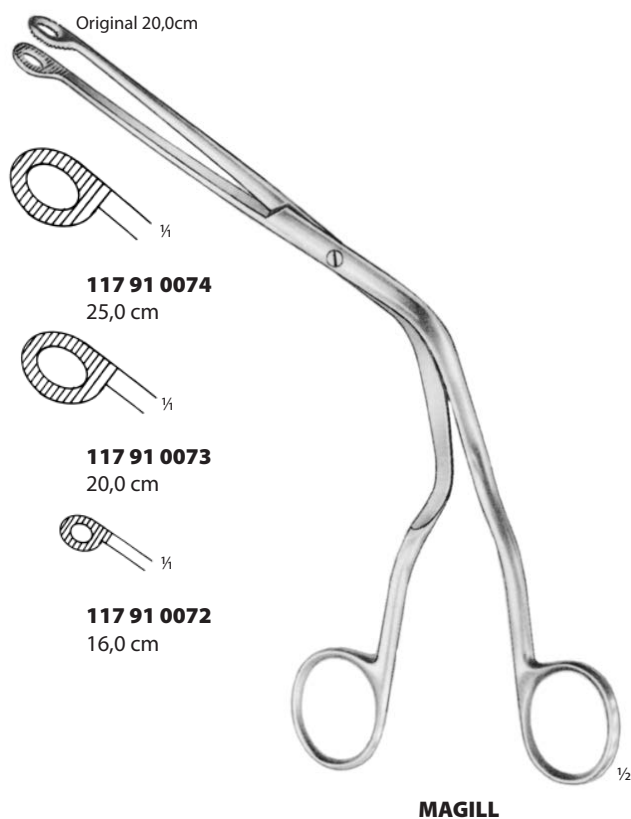
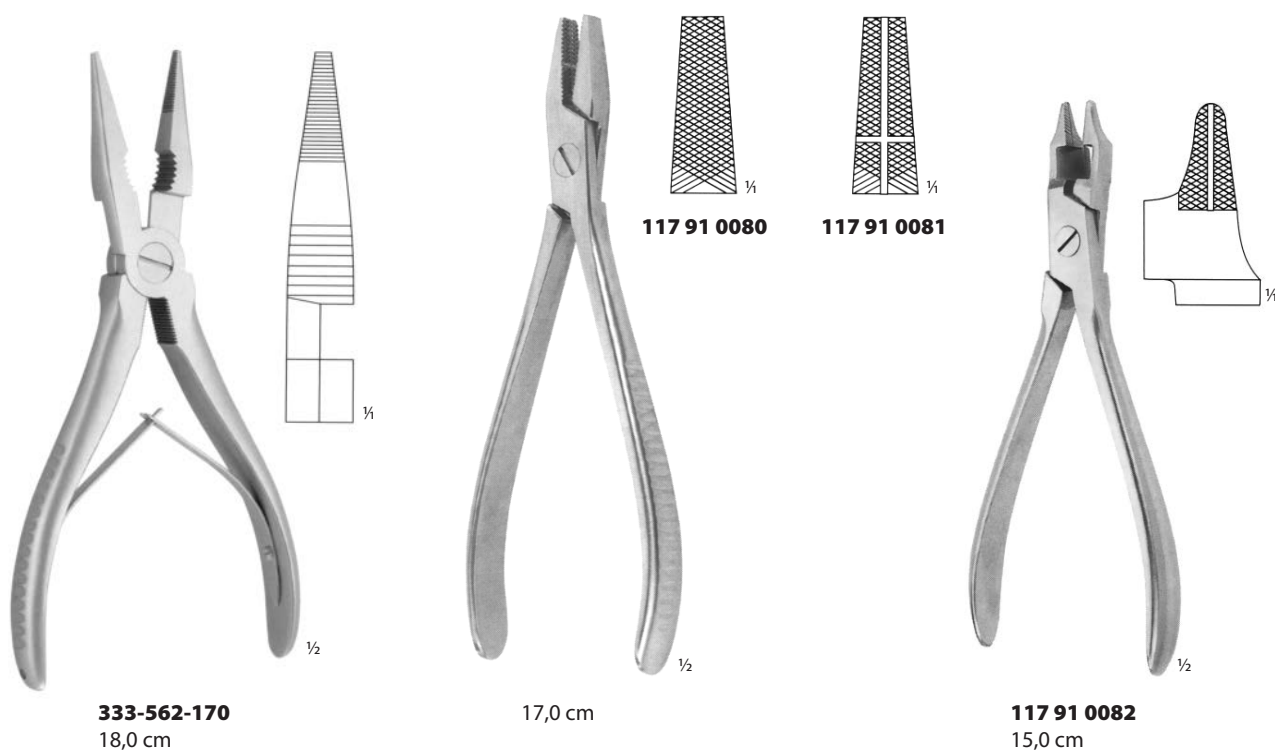

**STILLE**  
**117 91 0069** 23,0 cm  
**117 91 0070** 26,0 cm  
**117 91 0071** 37,0 cm

KLEŠTĚ NA ZAVÁDĚNÍ ENDOTRACHEÁLNÍCH ROUREK  
CATHETER INTRODUCING FORCEPSKLEŠTĚ ÚCHOPNÉ NA DRÁT  
WIRE GRASPING FORCEPS

KLEŠTĚ NA VYTAHOVÁNÍ KOSTNÍCH PRUTŮ  
NAIL EXTRACTION FORCEPS

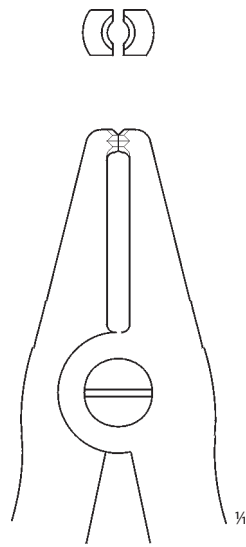

**117 09 0260**  
21,5 cm  
na pruty do průměru 2,5 mm  
for nail up to diameter 2,5 mm

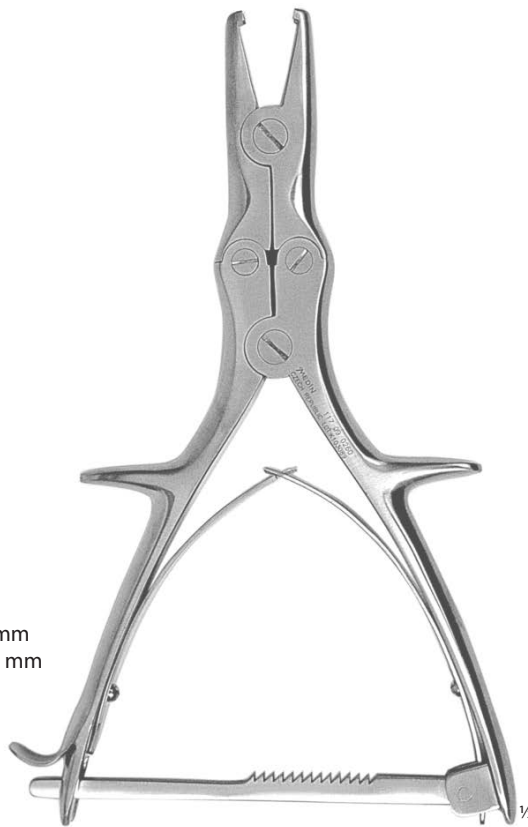

**BARTL**

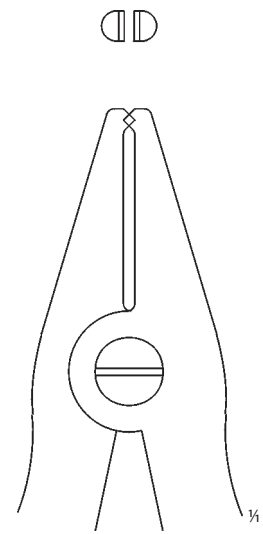

**117 09 0270**  
21,5 cm  
na pruty do průměru 2,0 mm  
for nail up to diameter 2,0 mm

KLEŠTĚ NA DRŽENÍ KOSTÍ  
BONE HOLDING FORCEPS



**117 08 0020**  
20,0 cm

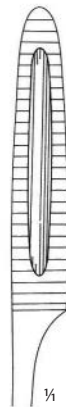

**FERGUSSON**  
**117 08 0040**  
21,0 cm

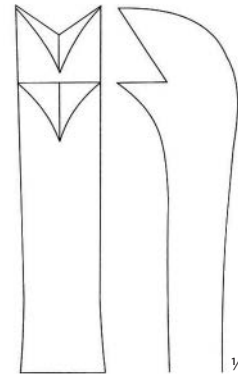



**117 99 0039**  
23,5 cm

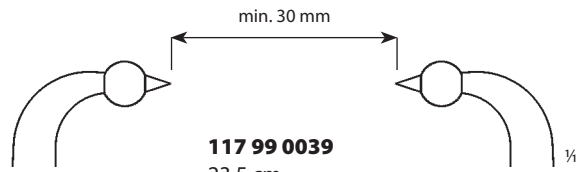

**117 99 0039**  
23,5 cm  
s kuličkou Ø 6 mm  
with ball Ø 6 mm

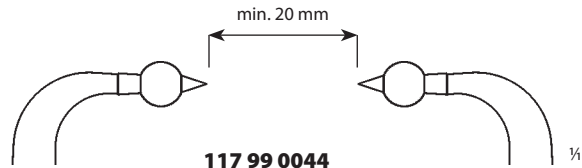

**117 99 0044**  
23,5 cm  
s kuličkou Ø 6 mm  
with ball Ø 6 mm

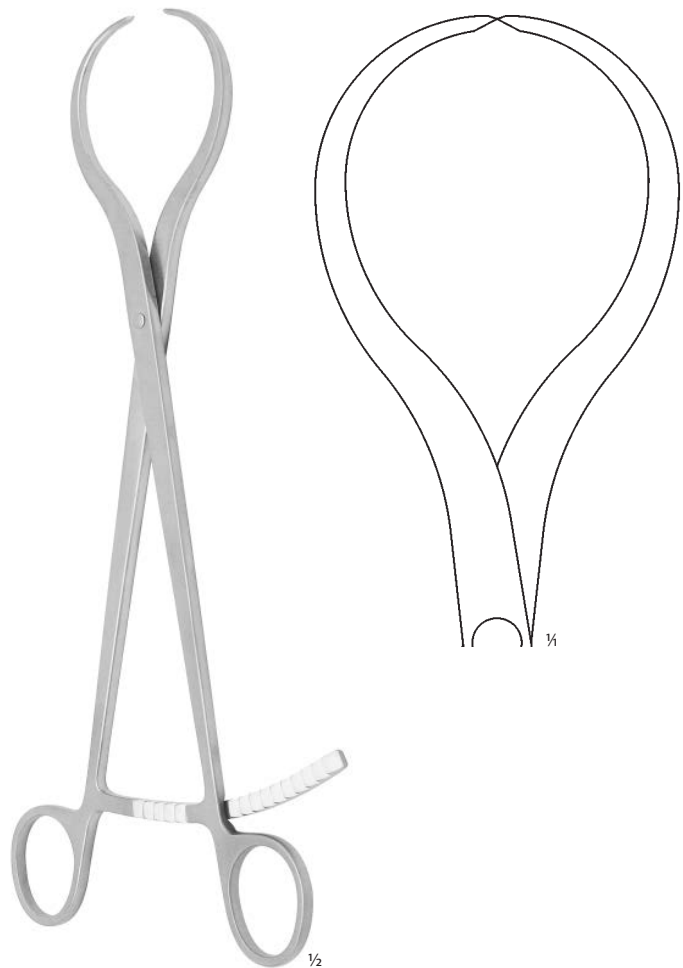

**117 99 0041**  
25,0 cm



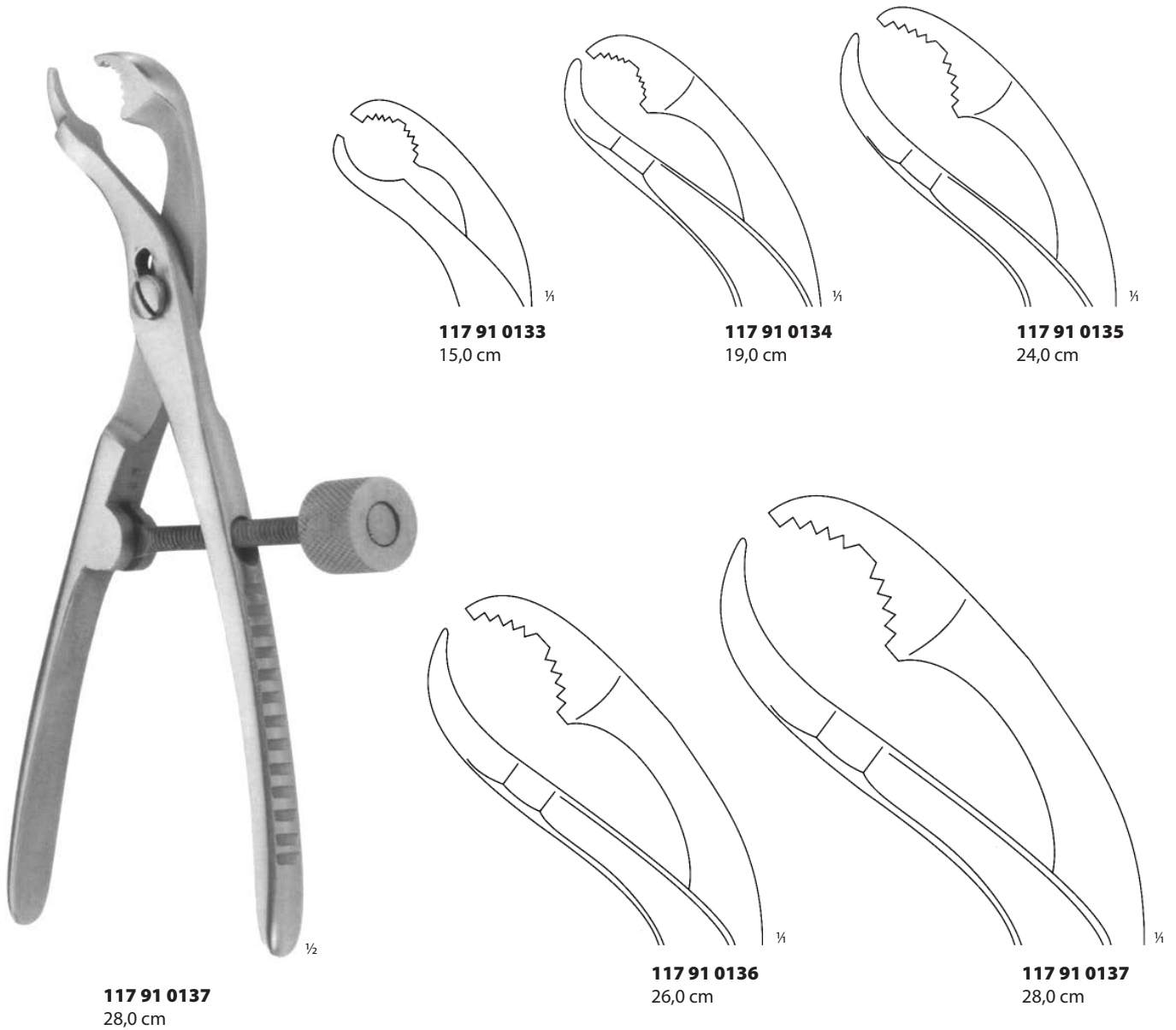

**117 91 0137**  
28,0 cm

**117 91 0133**  
15,0 cm

**117 91 0134**  
19,0 cm

**117 91 0135**  
24,0 cm

**117 91 0136**  
26,0 cm

**117 91 0137**  
28,0 cm

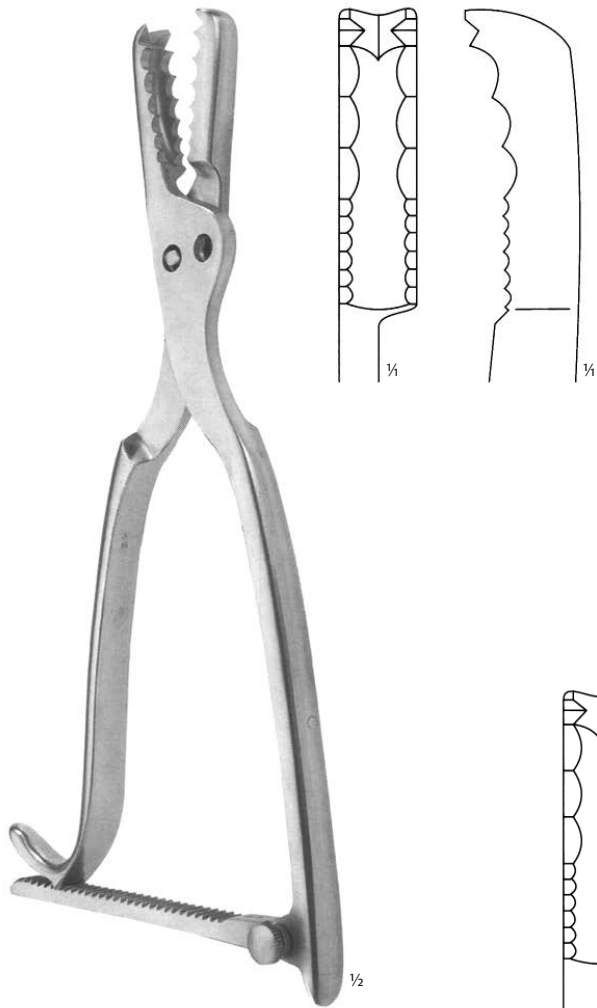

**FARABEUF-LAMBOTTE**  
**117 91 0117**  
26,0 cm  
11,0 mm

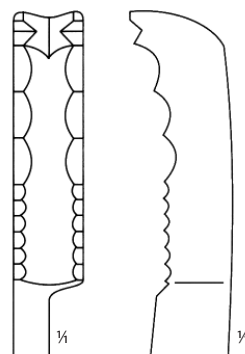

**117 91 0118**  
23,0 cm  
9,0 mm

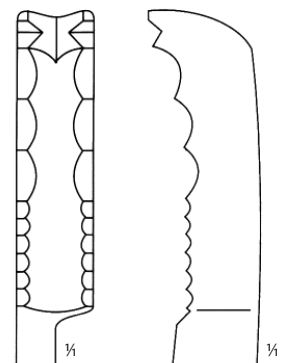

**117 91 0119**  
26,0 cm  
11,0 mm

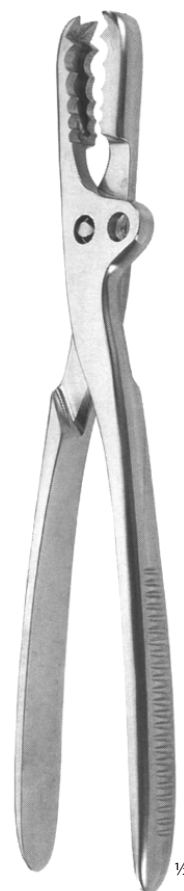

**FARABEUF**  
**117 91 0118**  
23,0 cm



**VERBRUGGE**  
**117 91 0122**  
26,0 cm

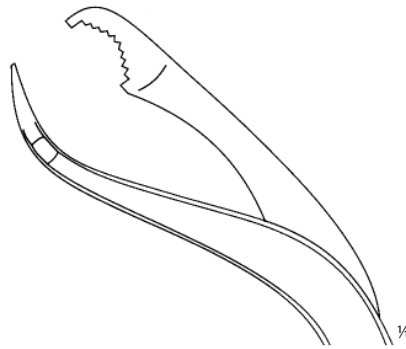

**117 91 0120**  
17,5 cm  
5,0 mm

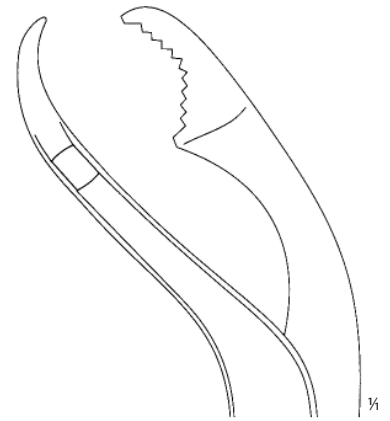

**117 91 0121**  
25,0 cm  
9,5 mm

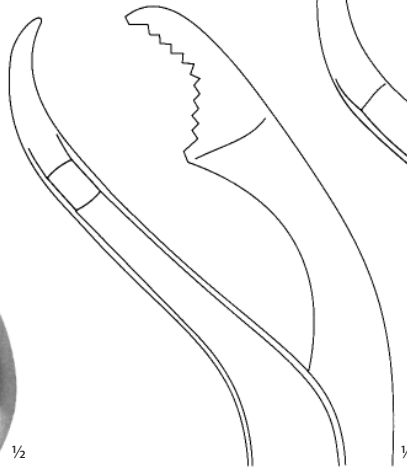

**117 91 0122**  
26,0 cm  
10,5 mm

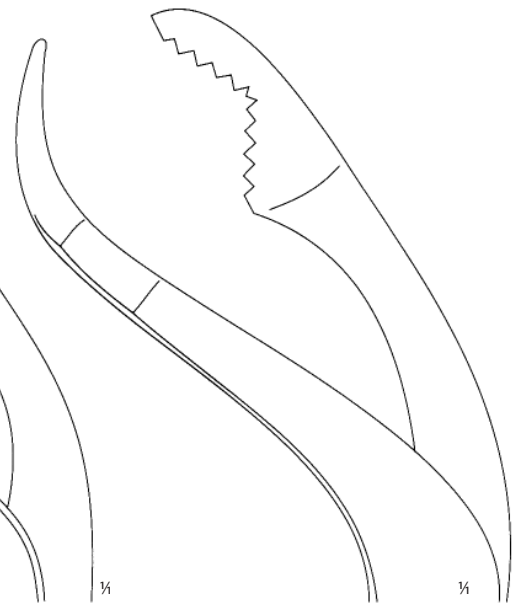

**117 91 0123**  
27,0 cm  
12,0 mm



**DUVAL**  
**117 14 0130**  
22,0 cm

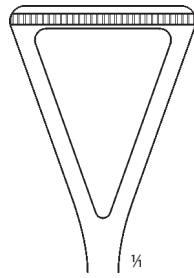

**117 14 0130**  
26 mm  
22,0 cm

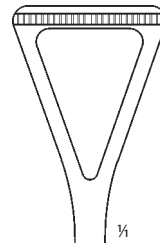

**117 14 0120**  
21 mm  
22,0 cm

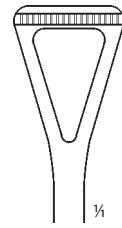

**117 14 0110**  
16 mm  
22,0 cm

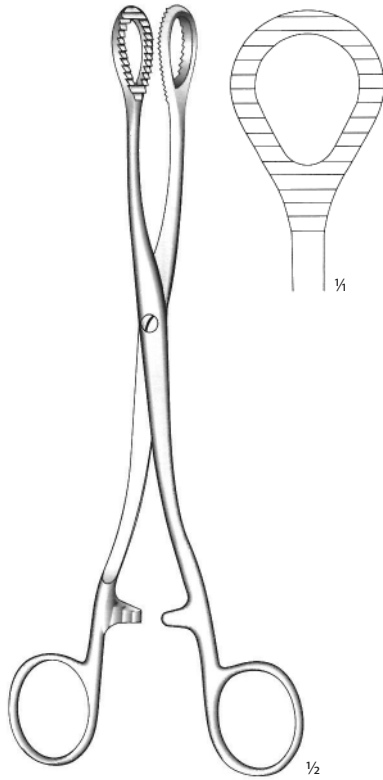

**117 19 0020**  
20,0 cm

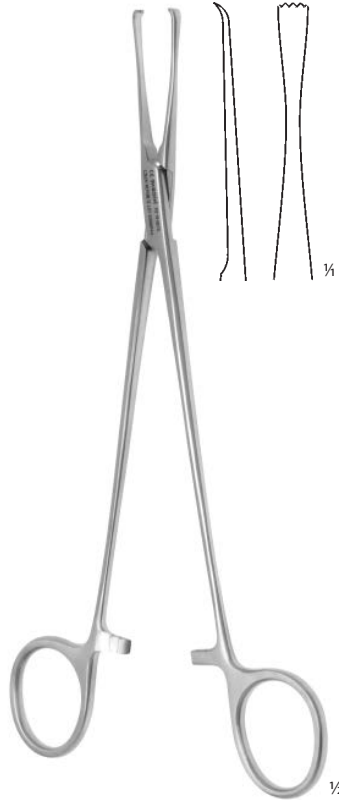

**ALLIS**  
**117 19 0070**  
21,0 cm

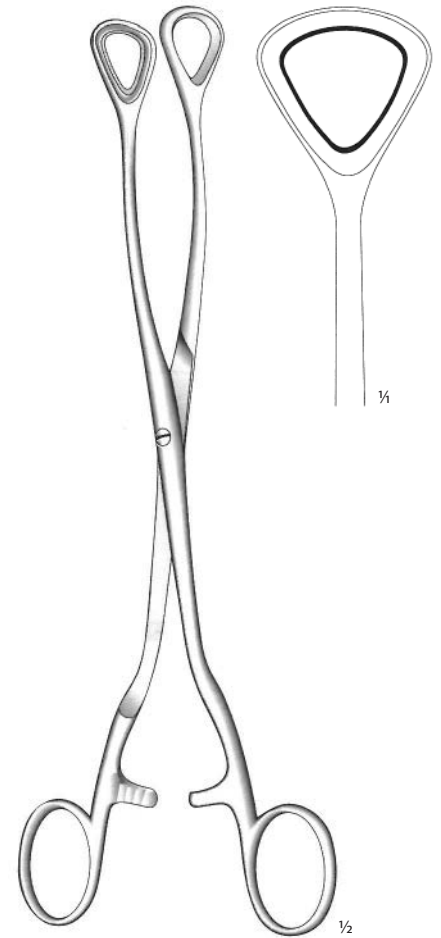

**COLLIN**  
**117 22 0160**  
24,5 cm

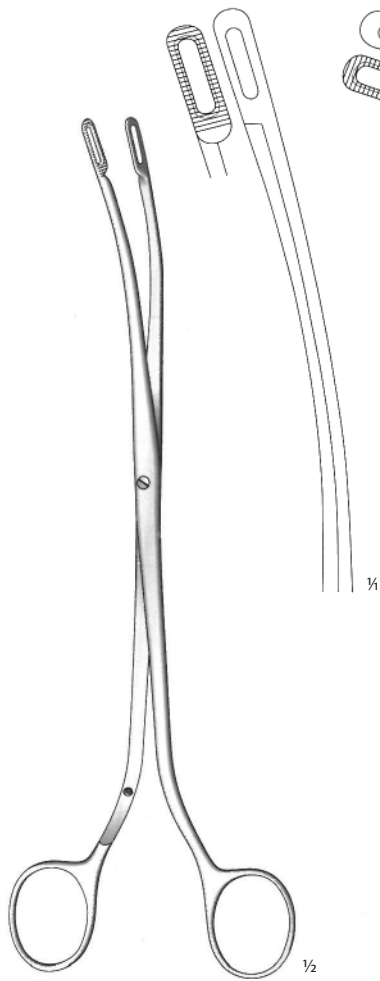

**RANDALL**  
**117 22 0270**  
21,0 cm  
Fig. 1

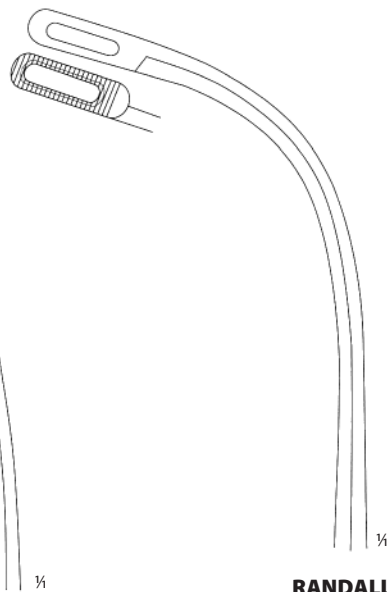

**RANDALL**  
**117 22 0280**  
19,8 cm  
Fig. 2

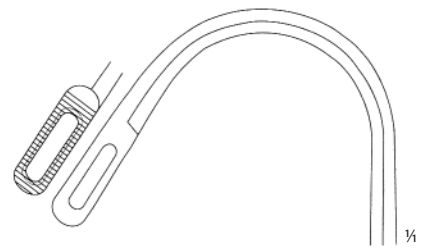

**RANDALL**  
**117 22 0290**  
18,5 cm  
Fig. 3

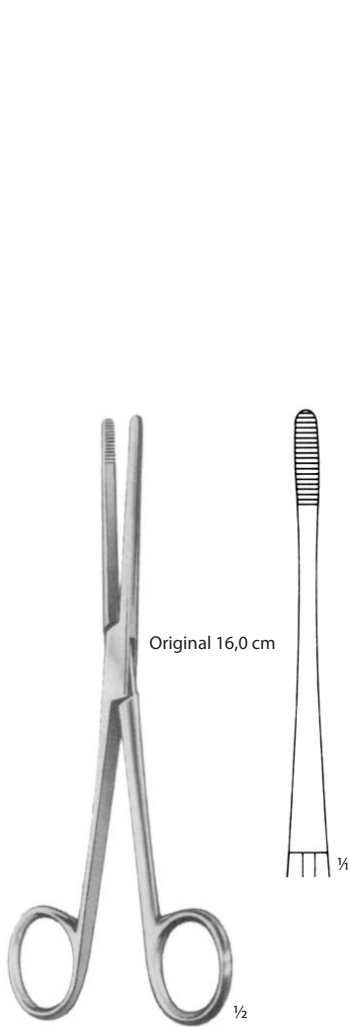

**LISTER**  
**117 91 0001** 13,0 cm  
**117 91 0002** 16,0 cm  
**117 91 0003** 18,0 cm

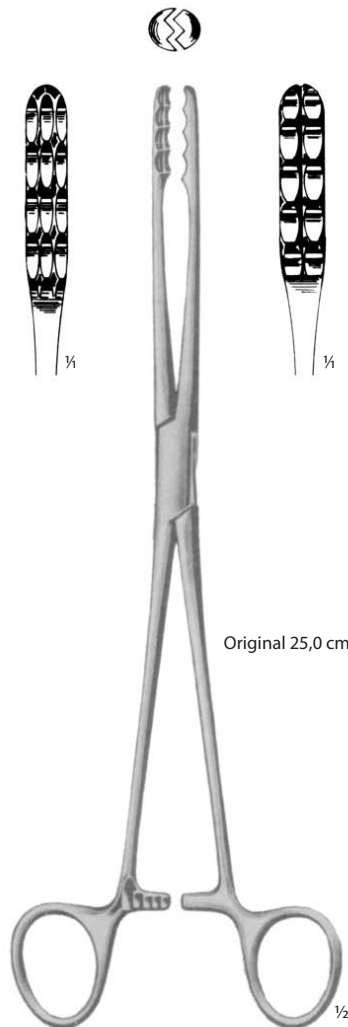

**ULRICH**  
**117 91 0004** 22,0 cm  
**117 91 0005** 25,0 cm

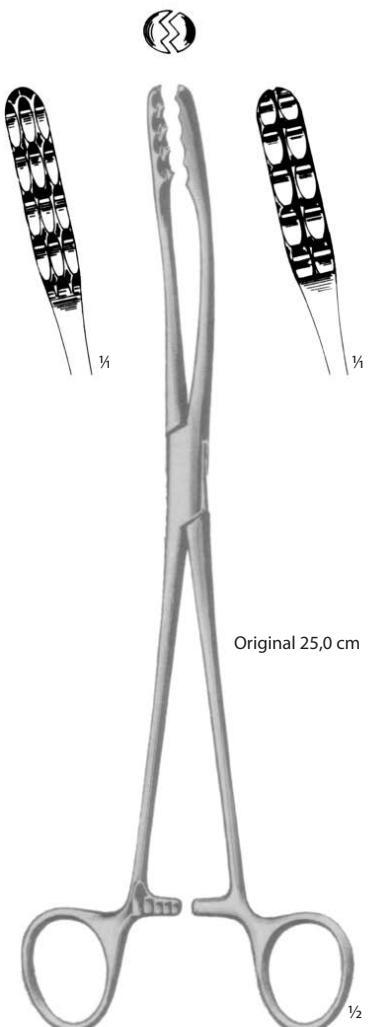

**ULRICH**  
**117 91 0007** 22,0 cm  
**117 91 0008** 25,0 cm

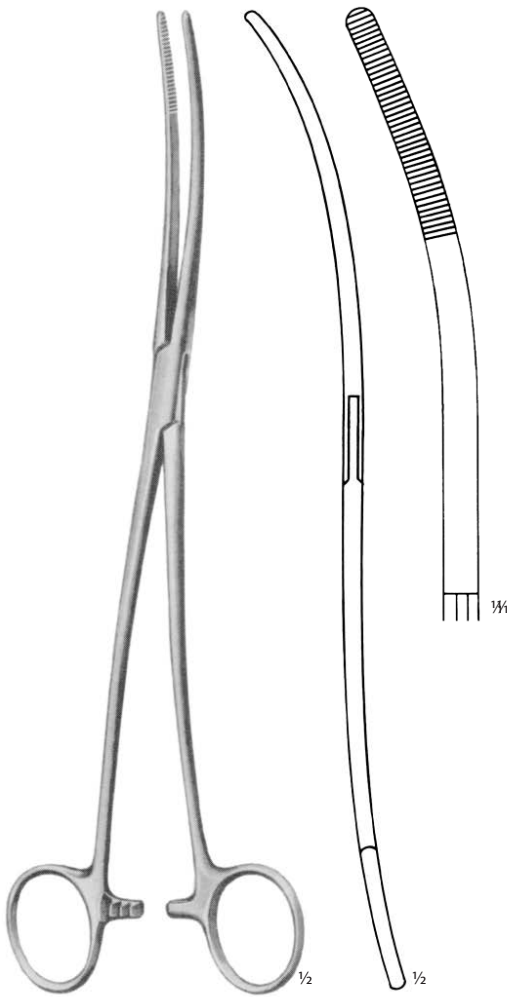

**BOZEMANN**  
**117 27 0510**  
26,0 cm



**COLLIN**  
**117 91 0033**  
24,0 cm



**NOTTO**  
**117 91 0034**  
27,5 cm





**PELKMANN**  
**117 91 0035**  
25,0 cm

**KELLY**  
**117 91 0037**  
32,0 cm

**HEYWOOD-SMITH**  
**117 91 0038**  
21,0 cm

**HEYWOOD-SMITH**  
**117 91 0039**  
25,0 cm



**GROSS-MAIER**  
25,0 cm

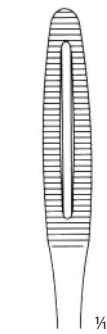

**117 27 0260**  
rovné  
zahnuté

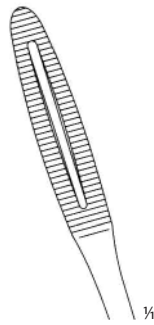

**117 27 0280**  
zahnuté  
curved

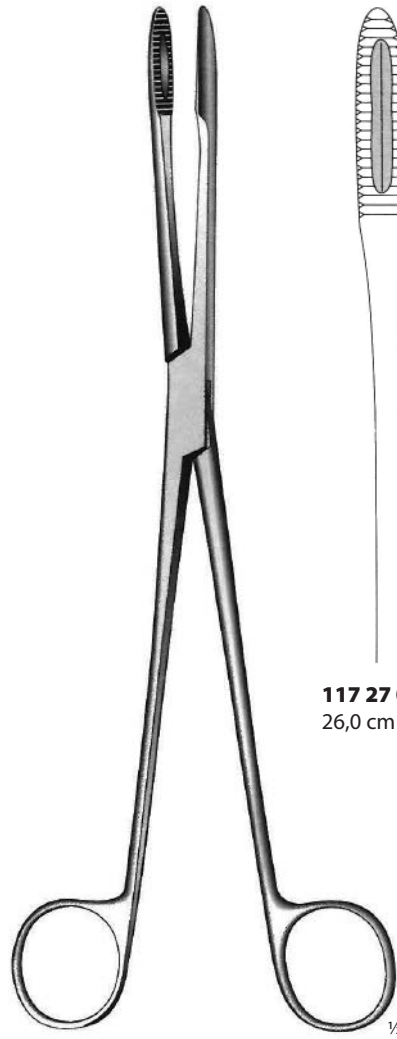

**GROSS-MAIER**  
bez záchyty  
without ratchet  
26,5 cm



**117 27 0270**  
26,0 cm

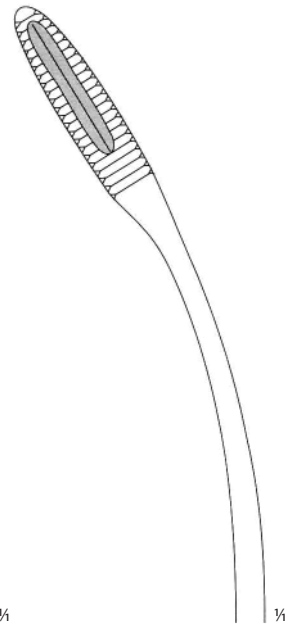

**117 27 0290**  
25,7 cm



**FOERSTER-BALLENGER**  
18,0 cm



**117 91 0042**  
18,0 cm

**117 91 0043**  
20,0 cm

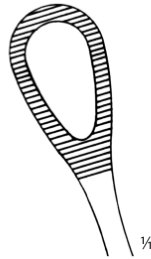

**117 91 0045**  
18,0 cm

**117 91 0046**  
20,0 cm



**117 91 0048**  
18,0 cm

**117 91 0049**  
20,0 cm



**117 91 0051**  
18,0 cm

**117 91 0052**  
20,0 cm



**FOERSTER-BALLENGER**  
25,0 cm

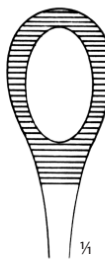

**117 91 0044**

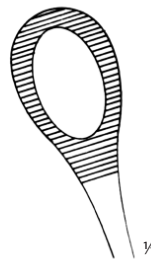

**117 91 0047**



**117 91 0050**



**117 91 0053**

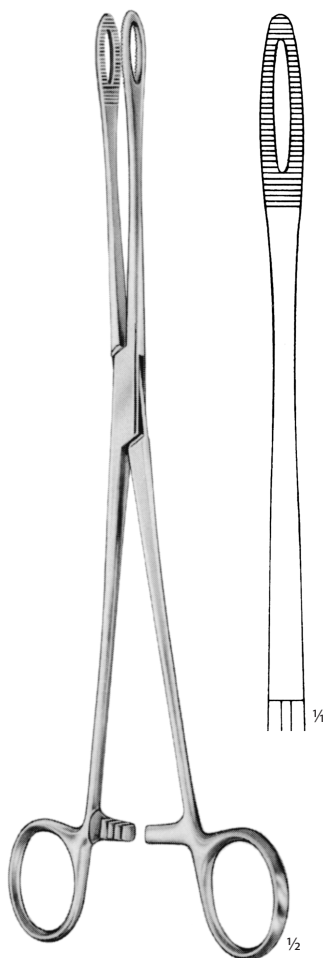

**FOERSTER**  
25,0 cm

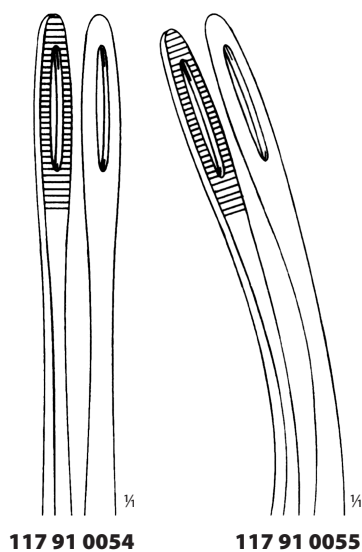

**117 91 0054**

**117 91 0055**

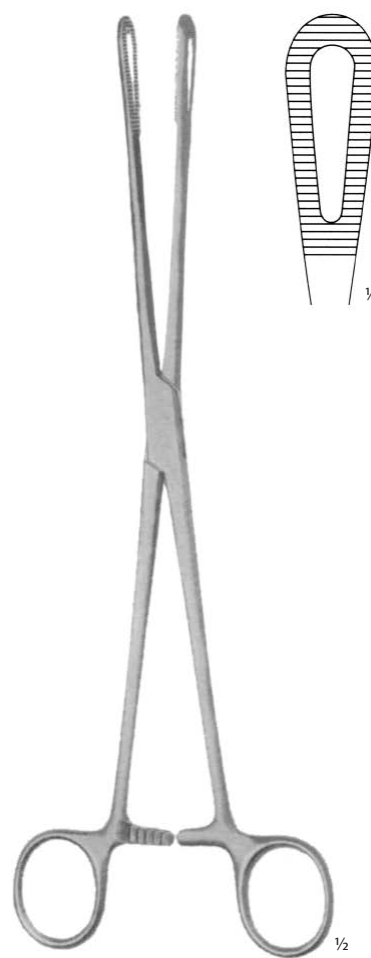

**RAMPLEY**  
**117 91 0056**  
25,0 cm

# 118

## HÁKY HOOKS, RETRACTORS

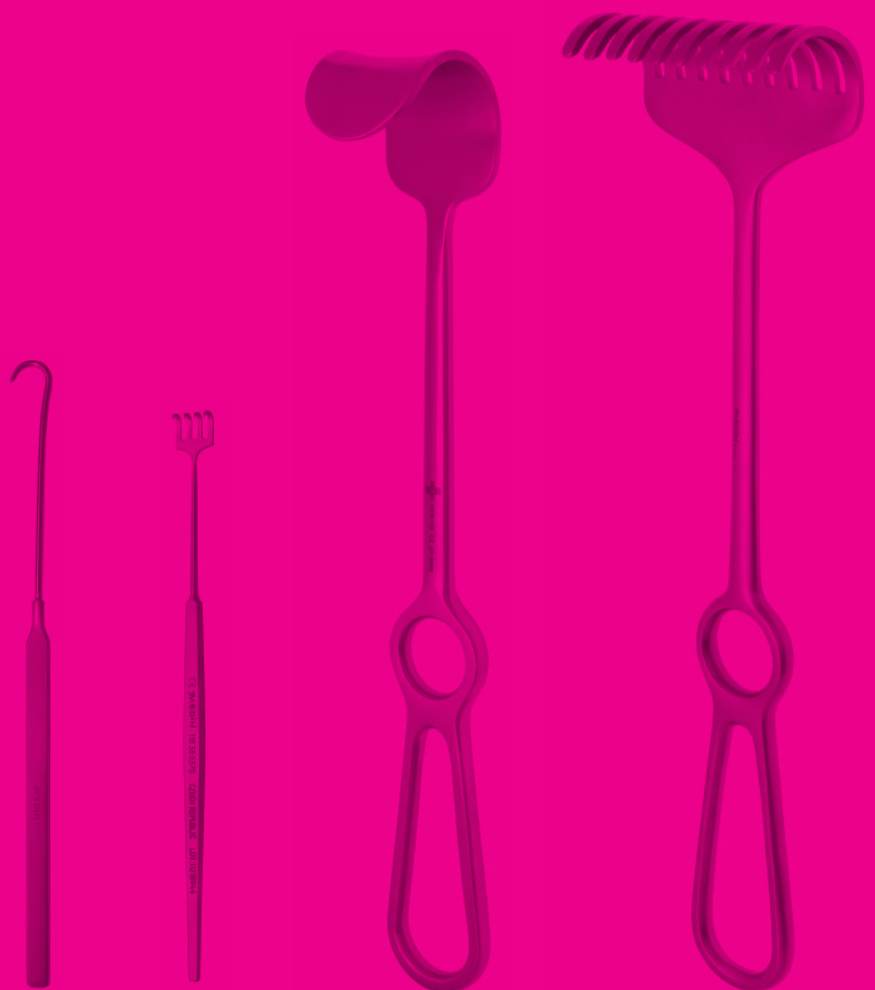





16,0 cm

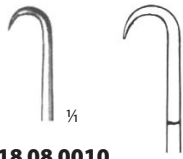

**118 08 0010**  
ostrý  
sharp



**118 08 0020**  
ostrý  
sharp



**118 91 0027**  
ostrý  
sharp



**118 91 0028**  
ostrý  
sharp



**118 08 0050**  
tupý  
blunt



**118 08 0060**  
tupý  
blunt



**118 91 0035**  
tupý  
blunt



**118 91 0036**  
tupý  
blunt



ohybný  
flexible  
16,0 cm

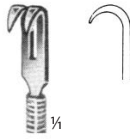

**118 91 0045**

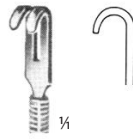

**118 91 0048**



**118 91 0046**



**118 91 0049**



**118 91 0047**  
ostrý  
sharp

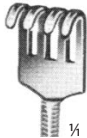

**118 91 0050**  
tupý  
blunt



**JOSEPH**  
**118 91 0051**  
16,0 cm



**JOSEPH**  
**118 91 0052**  
16,0 cm



**118 91 0052**  
2,0 mm



**118 91 0053**  
5,0 mm



**118 91 0054**  
7,0 mm



**118 91 0055**  
10,0 mm

HÁKY JEMNÉ  
DELICATE HOOKS



**CUSHING**  
28,0 cm



**118 91 0015**  
Fig. 1



**118 91 0016**  
Fig. 2

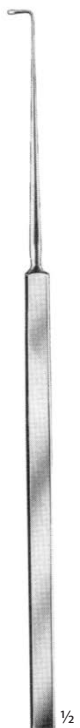

**CUSHING**  
19,0 cm



**118 91 0017**  
Fig. 1



**118 91 0018**  
Fig. 2



**GRAEFE**  
16,0 cm



**118 91 0013**  
ostrý  
sharp



**118 91 0014**  
tupý  
blunt



16,0 cm



**118 91 0008**  
Fig. 1



**118 91 0009**  
Fig. 2



**118 91 0010**  
Fig. 3



**118 91 0011**  
Fig. 4





**DESMARRES**  
13,0 cm

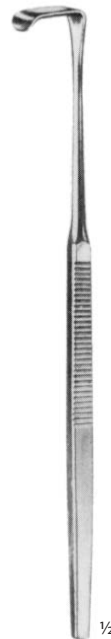
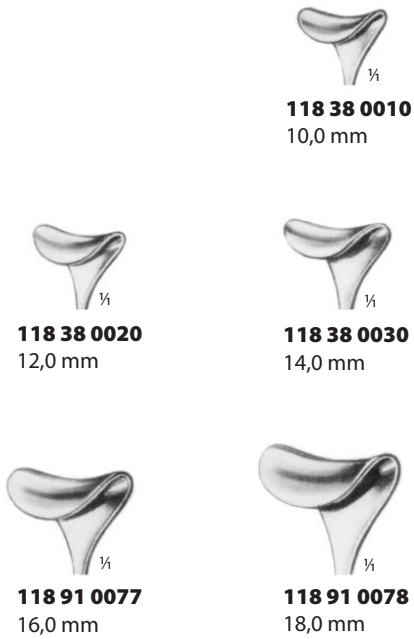

**MINI-LANGENBECK**  
16,0 cm



**CUSHING**  
20,0 cm

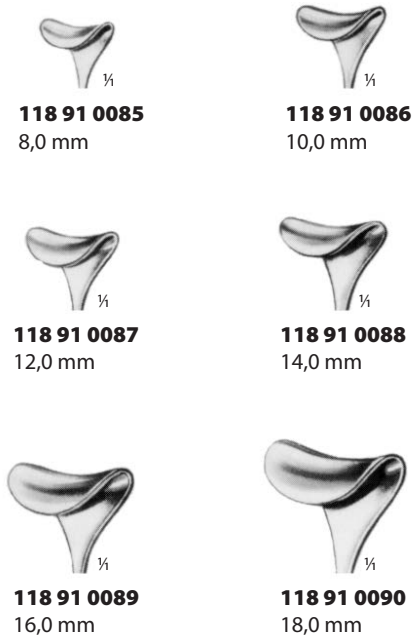

**CUSHING**  
24,0 cm

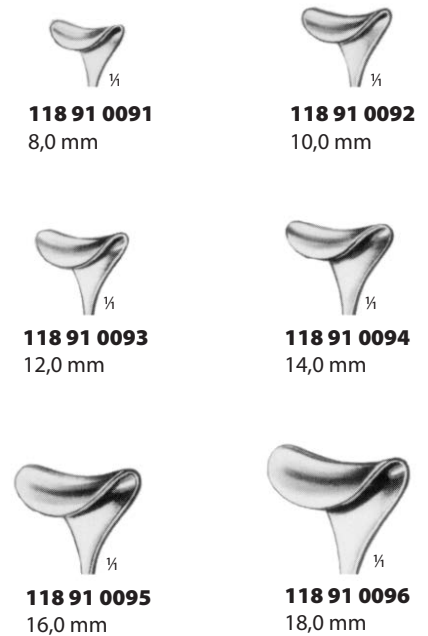

HÁKY JEMNÉ, HÁKY OČNÍ  
DELICATE HOOKS, EYE HOOKS

**GRAEFE**  
**118 38 0050**  
ostrý  
sharp  
13,0 cm



**GRAEFE**  
**118 38 0060**  
tupý  
blunt  
14,0 cm



**118 38 0210**  
13,5 cm



**118 38 0210**  
1,5 mm uvnitř  
1.5 mm inside



**118 38 0220**  
2,0 mm uvnitř  
2.0 mm inside



**118 38 0230**  
3,0 mm uvnitř  
3.0 mm inside



**118 38 0360**  
14,5 cm

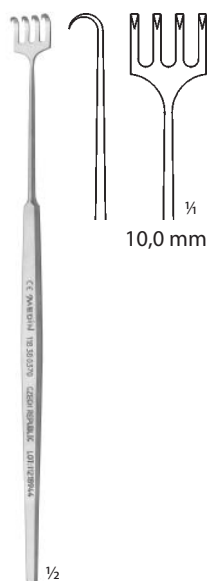

**118 38 0370**  
15,0 cm



14,5 cm

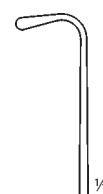

**GRAEFE**  
**118 38 0420**



**JAEGER**  
**118 38 0460**

HÁKY JEMNÉ, HÁKY PÁTEŘNÍ, HÁKY RESEKČNÍ  
DELICATE HOOKS, SPINAL HOOKS, RESECTION HOOKS



**GIL-VERNET**  
24,5 cm



**118 91 0097**  
9,0 mm



**118 91 0098**  
11,0 mm



**118 91 0100**  
15,0 mm



**118 91 0101**  
18,0 mm



**118 91 0109**  
ostrý  
sharp



**118 91 0110**  
tupý  
blunt



**SENN-MILLER**  
16,0 cm

HÁKY NA RÁNY  
RETRACTORS



**VOLKMANN**  
21,5 cm

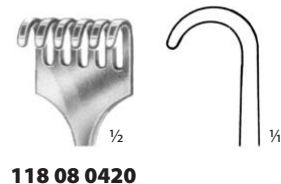
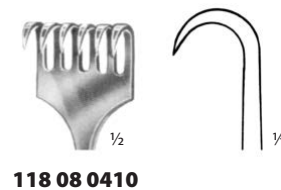

**KOCHER**  
22,0 cm

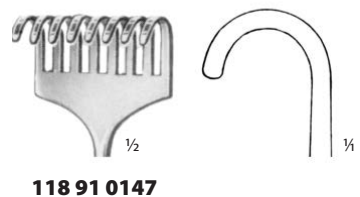
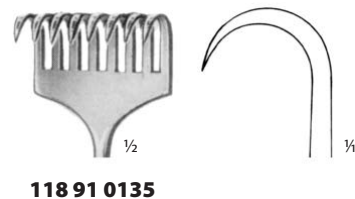



**VOLKMANN**  
21,5 cm



**118 08 0320**

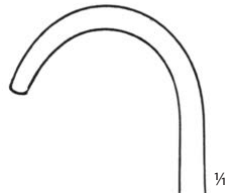

**118 08 0340**



**KOERTE**  
24,0 cm



**118 91 0152**



**118 91 0153**

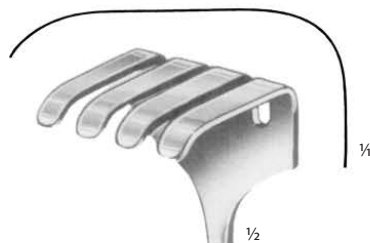

**118 08 0530**  
24,0 cm  
40 × 35 mm

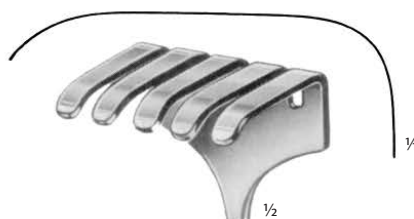

**118 91 0160**  
25,0 cm  
45 × 50 mm

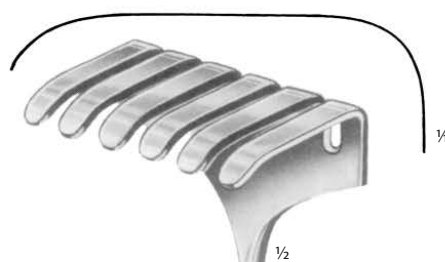

**118 08 0540**  
26,0 cm  
45 × 68 mm



**118 91 0162**  
25,0 cm  
70 × 70 mm



**ISRAEL**



**LANGENBECK**  
21,0 cm

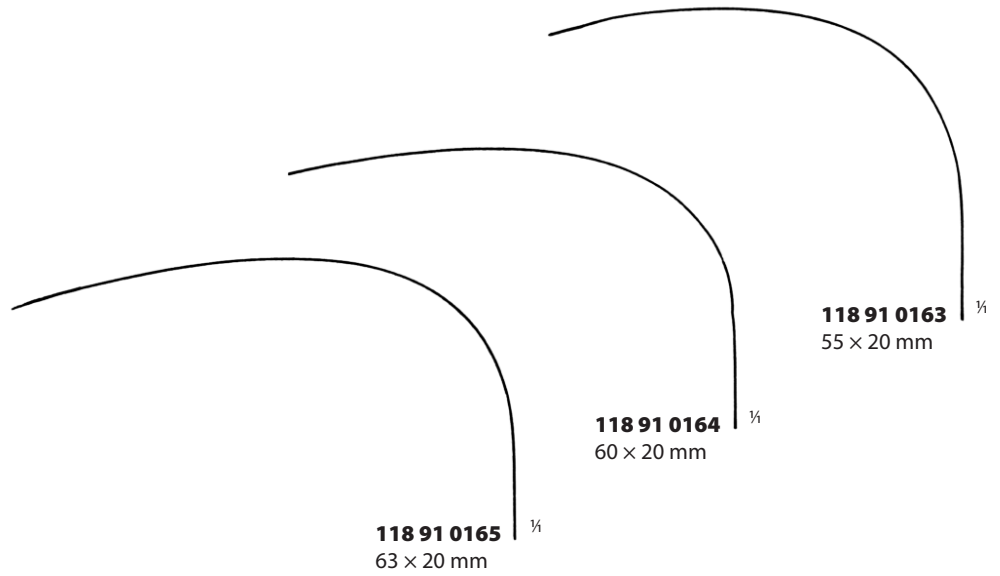

**LANGENBECK**

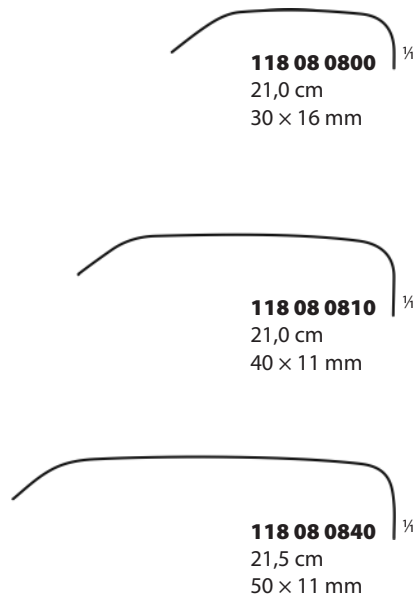



**KOCHER**  
23,0 cm



**118 08 1050**  
40 × 35 mm



**118 91 0185**  
40 × 18 mm

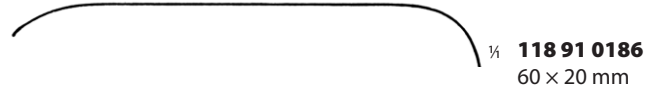

**118 91 0186**  
60 × 20 mm

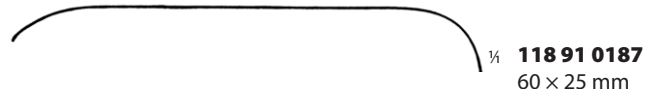

**118 91 0187**  
60 × 25 mm

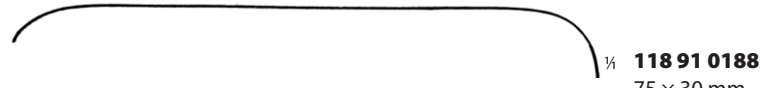

**118 91 0188**  
75 × 30 mm

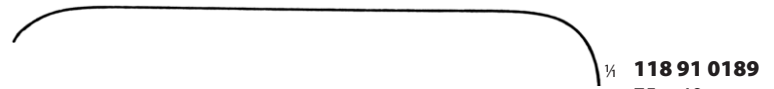

**118 91 0189**  
75 × 40 mm

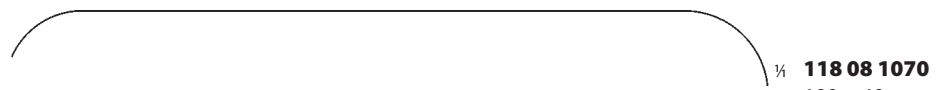

**118 08 1070**  
100 × 40 mm



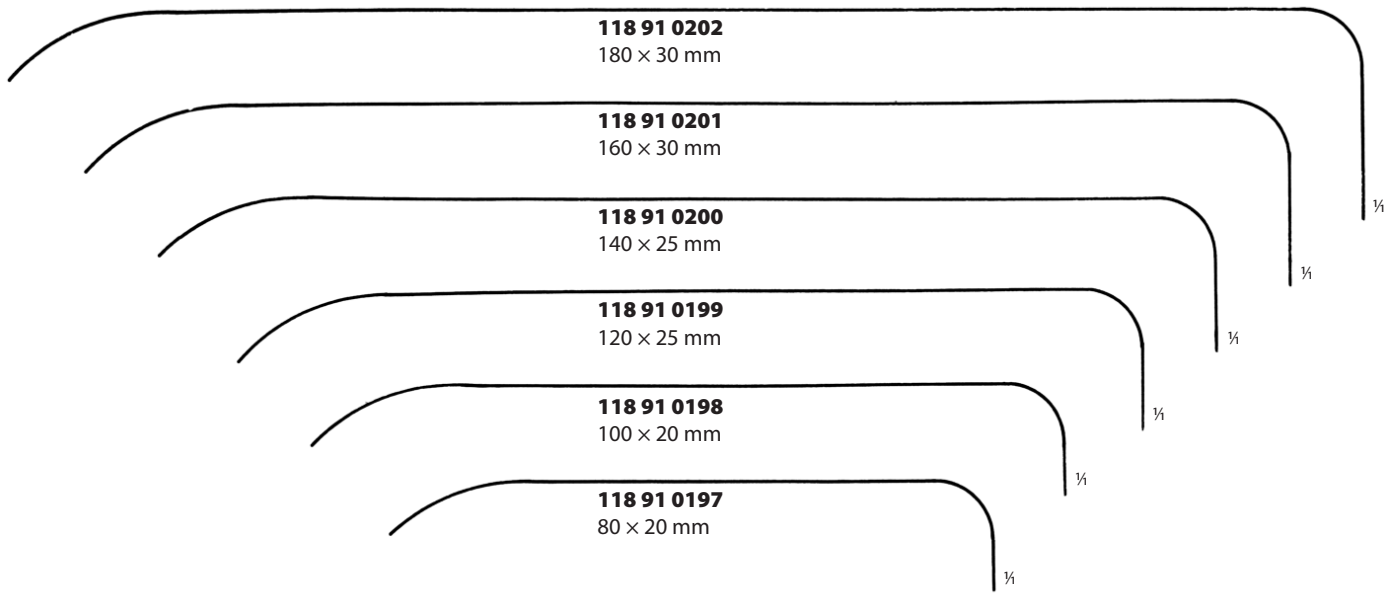

**BRUNNER**  
25,0 cm

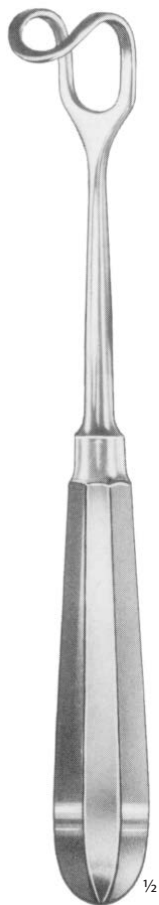

MIDDELDORPF

14 × 17 mm  
**118 91 0208**  
21,5 cm20 × 22 mm  
**118 91 0209**  
22,0 cm26 × 30 mm  
**118 91 0210**  
23,5 cm

MIDDELDORPF

14 × 17 mm  
**118 08 0650**  
21,5 cm20 × 22 mm  
**118 08 0660**  
22,0 cm26 × 30 mm  
**118 08 0670**  
23,5 cm62 × 50 mm  
**118 08 0680**  
28,0 cm



**RICHARDSON (KELLY)**  
24,0 mm



**118 91 0211**  
28 × 20 mm



**118 91 0212**  
36 × 28 mm



**118 91 0213**  
44 × 38 mm



**118 91 0214**  
52 × 22 mm



**118 91 0215**  
65 × 50 mm



Fig.1

Fig.2

36 × 28 mm

63 × 49 mm

**RICHARDSON-EASTMAN**  
**118 91 0216** Fig.1+2

Fig.1  
**118 91 0217**  
26,0 cm

Fig.2  
**118 91 0218**  
28,0 cm

**118 08 1080**  
120 × 30 mm  
24,0 cm

**118 08 1090**  
140 × 50 mm  
24,5 cm



**FRITSCH**  
**118 08 1120**  
40 × 40 mm  
24,0 cm

**FRITSCH**  
**118 08 1130**  
50 × 80 mm  
27,0 cm

**FRITSCH**  
24,0 cm  
**118 91 0225** 45 × 40 mm  
**118 91 0226** 45 × 50 mm  
**118 91 0227** 45 × 60 mm  
**118 91 0228** 45 × 75 mm  
**118 91 0229** 65 × 85 mm

**118 08 1090**  
140 × 50 mm  
24,5 cm

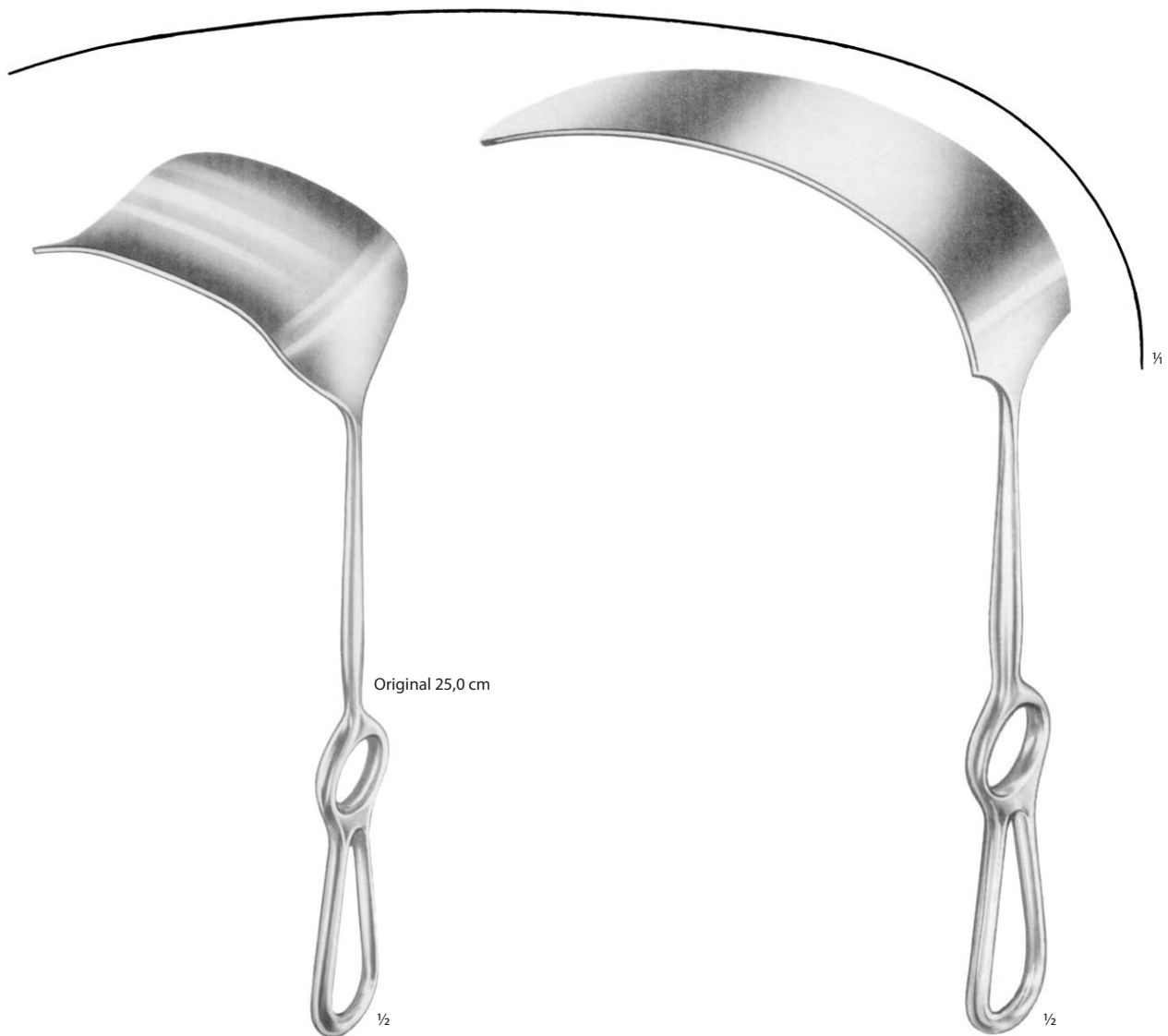

Original 25,0 cm

**KOCHER**

<b>118 91 0230</b>	22,0 cm	70 × 25 mm
<b>118 08 0550</b>	25,0 cm	80 × 40 mm
<b>118 08 0560</b>	25,0 cm	80 × 50 mm
<b>118 91 0233</b>	25,0 cm	80 × 60 mm

**KELLY**

27,0 cm	
<b>118 91 0249</b>	160 × 38 mm
<b>118 91 0250</b>	160 × 57 mm
<b>118 91 0251</b>	190 × 38 mm
<b>118 91 0252</b>	190 × 57 mm





**DEAVER**  
**118 91 0259**  
30,0 cm



**DEAVER**  
**118 91 0260**  
30,0 cm

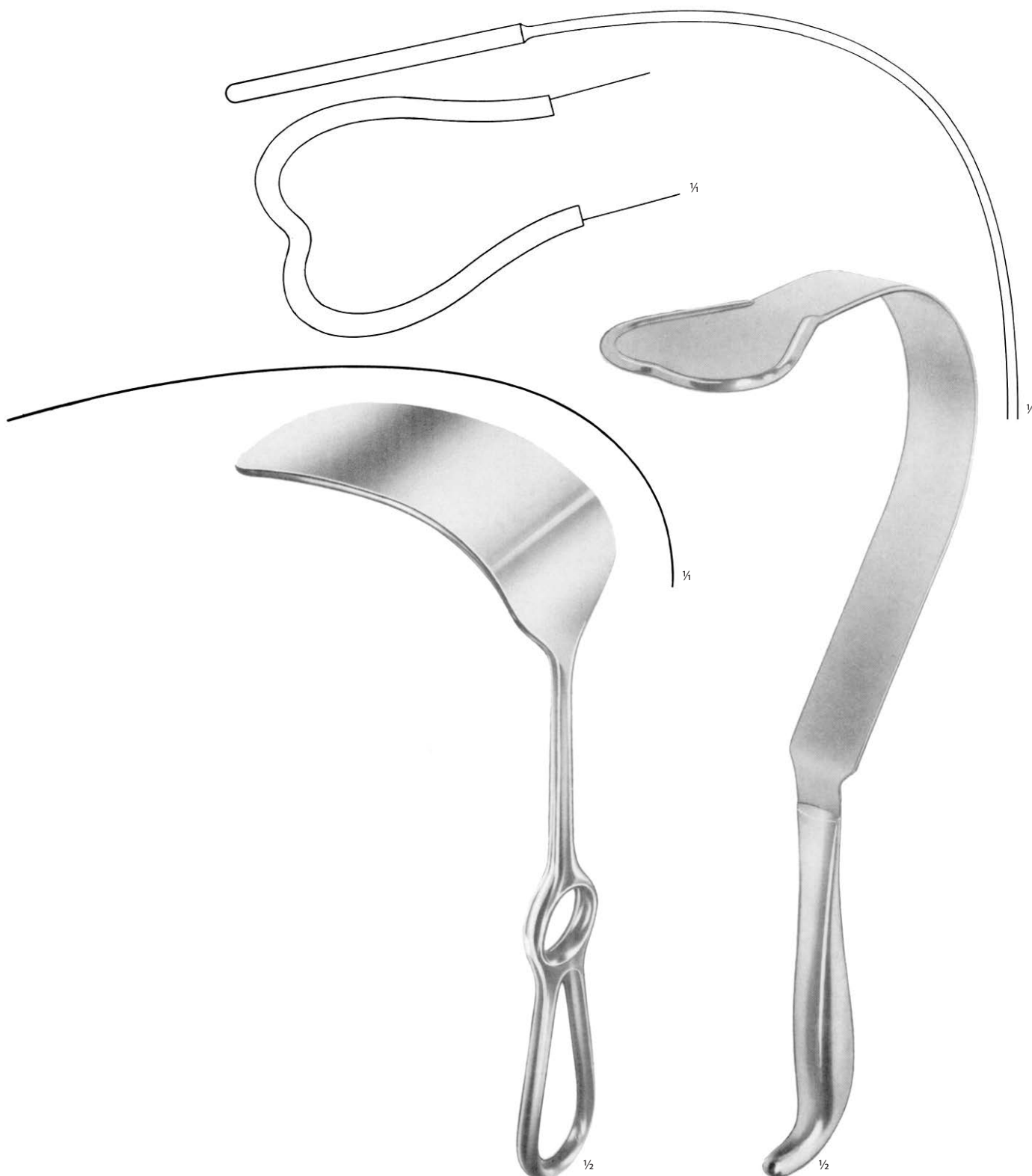

**DEAVER**  
**118 91 0261**  
30,0 cm

**MIKULICZ**

26,0 cm

**118 91 0246** 85 × 35 mm**118 08 1100** 115 × 30 mm**118 91 0247** 120 × 50 mm**118 08 1110** 135 × 50 mm**118 91 0248** 155 × 50 mm**HARRINGTON**

32,0 cm

**118 91 0242** 127 × 40 mm**118 91 0243** 127 × 62 mm**118 91 0244** 175 × 64 mm



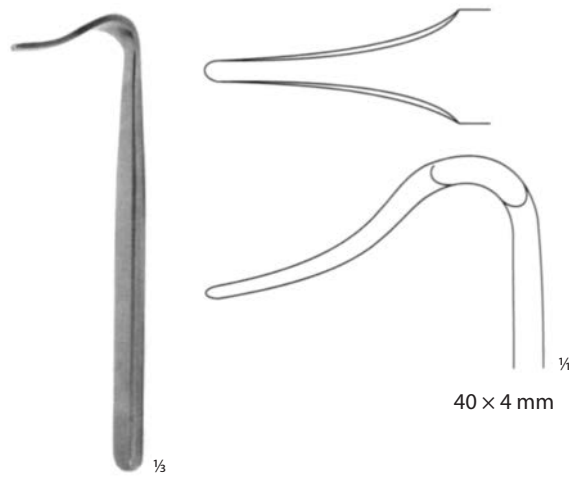

**BLOUNT**  
**118 91 0396**  
17,5 cm

HÁČKY NA PLASTIKU  
PLASTIC HOOKS

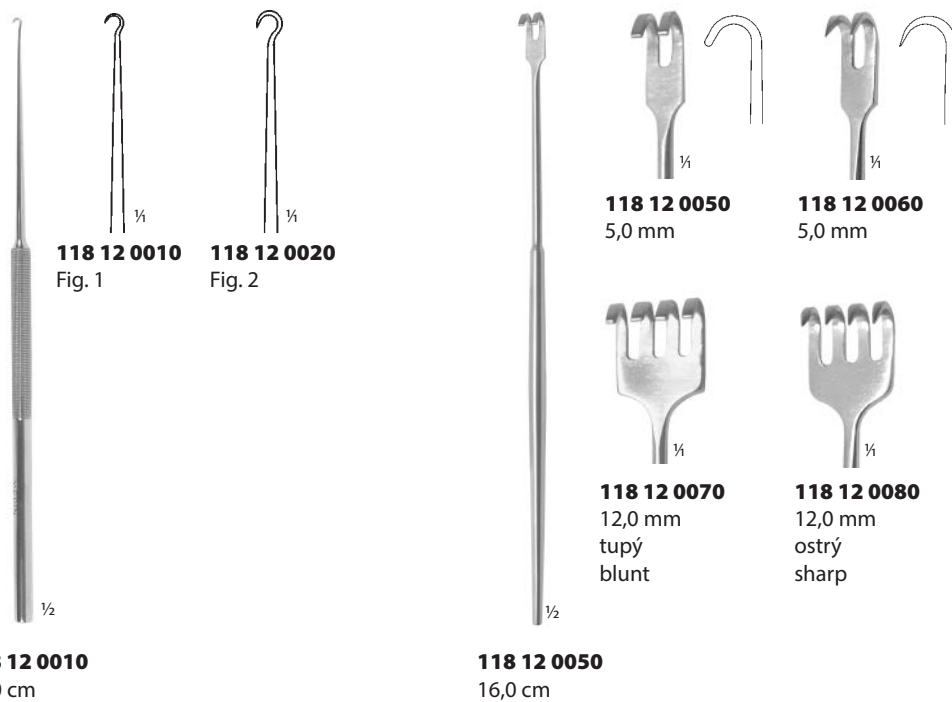

**118 12 0010**  
Fig. 1

**118 12 0020**  
Fig. 2

**118 12 0010**  
16,0 cm

**118 12 0050**  
5,0 mm

**118 12 0060**  
5,0 mm

**118 12 0070**  
12,0 mm  
tupý  
blunt

**118 12 0080**  
12,0 mm  
ostrý  
sharp

**118 12 0050**  
16,0 cm

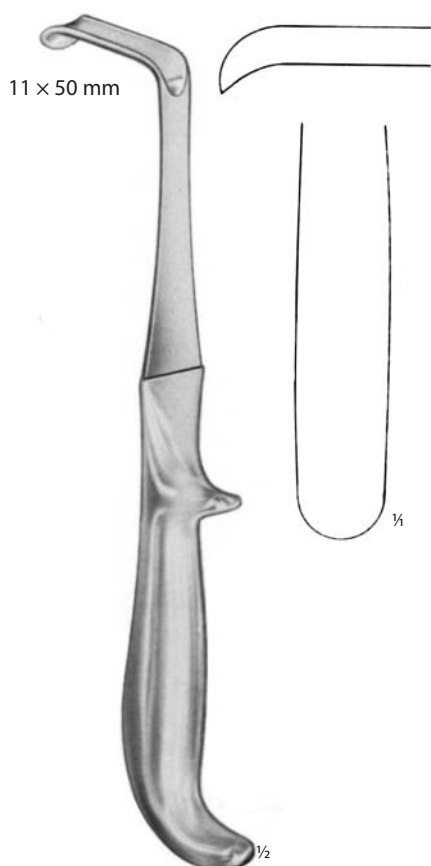
HÁKY NA PROSTATU  
PROSTATIC RETRACTORS

**YOUNG**  
**118 91 0409**  
21,0 cm

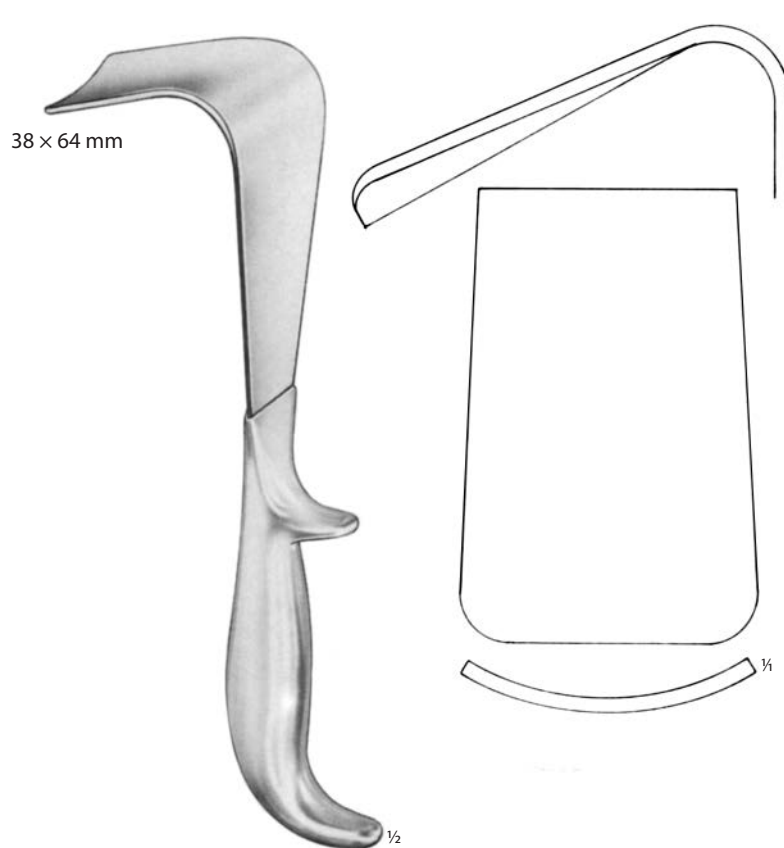

**YOUNG**  
**118 91 0410**  
22,0 cm

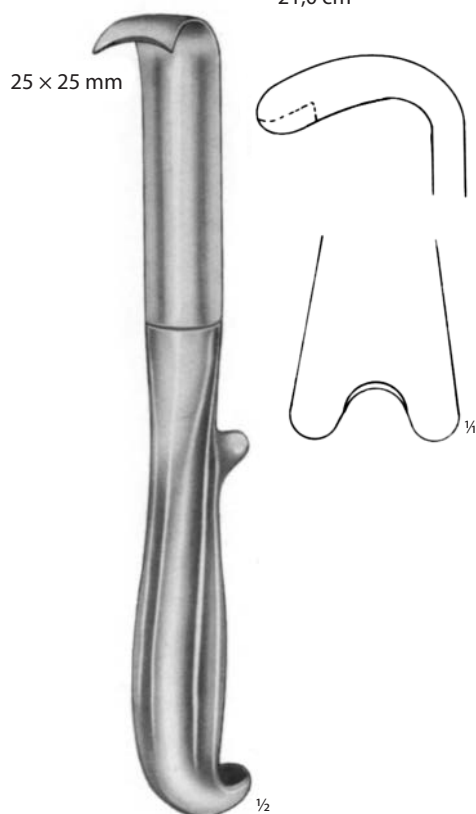

**YOUNG**  
**118 91 0411**  
21,0 cm

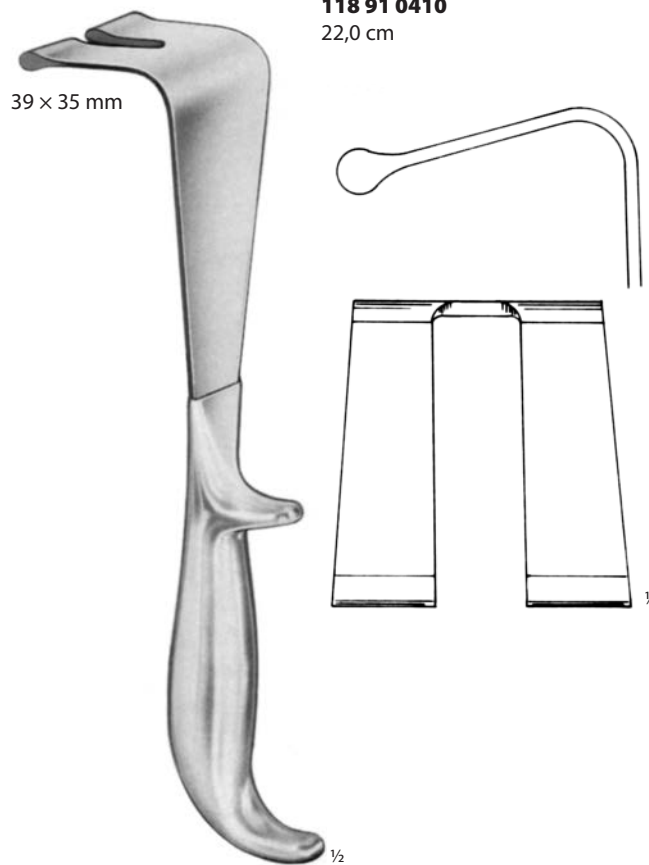

**YOUNG**  
**118 91 0412**  
22,0 cm

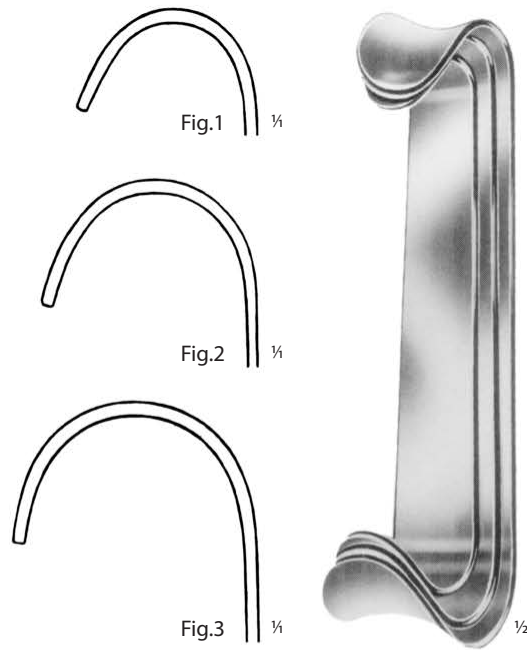

**ROUX**

**118 91 0294** Fig. 1-3 sada set  
16,5 cm

**118 91 0295** Fig. 1

**118 91 0296** Fig. 2

**118 91 0297** Fig. 3

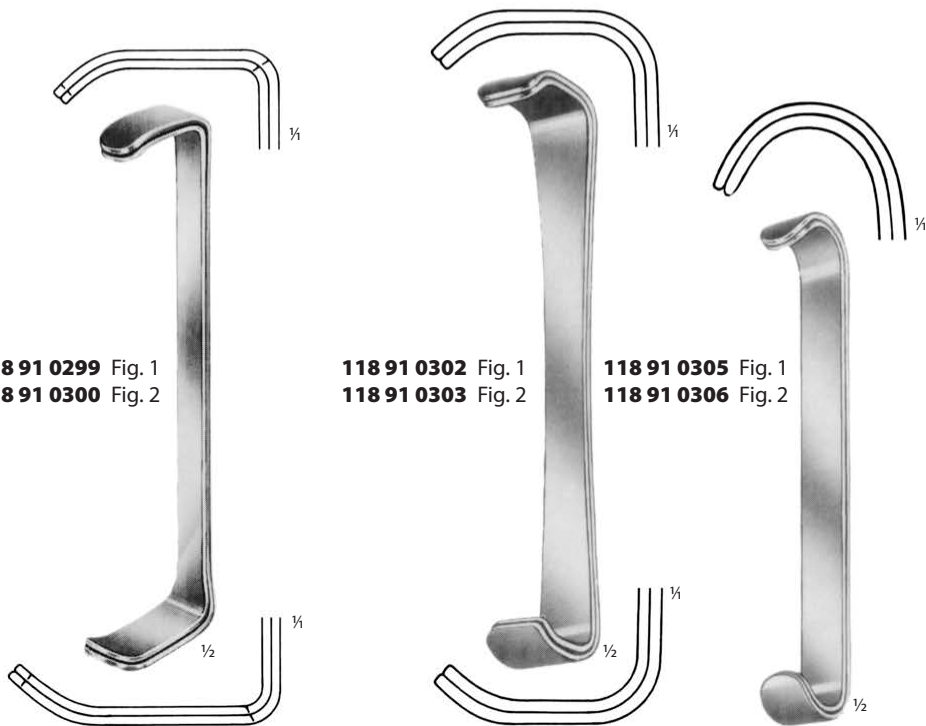

**118 91 0299** Fig. 1  
**118 91 0300** Fig. 2

**118 91 0302** Fig. 1  
**118 91 0303** Fig. 2

**118 91 0305** Fig. 1  
**118 91 0306** Fig. 2

**FARABEU**

**118 91 0298** Fig. 1+2  
12,0 cm

**FARABEU**

**118 91 0301** Fig. 1+2  
15,0 cm

**PARKER**

**118 91 0304** Fig. 1+2  
13,5 cm

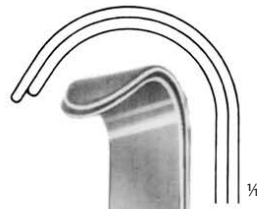

**118 91 0308** Fig. 1  
**118 91 0309** Fig. 2

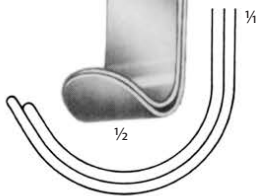

**PARKER**  
**118 91 0307** Fig. 1+2  
18,0 cm



**118 91 0311** Fig. 1  
**118 91 0312** Fig. 2

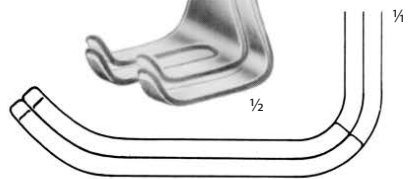

**MATHIEU**  
**118 91 0310** Fig. 1+2  
20,0 cm



**118 91 0314** Fig. 1  
**118 91 0315** Fig. 2



**PARKER-LANGENBECK**  
**118 91 0313** Fig. 1+2  
21,0 cm

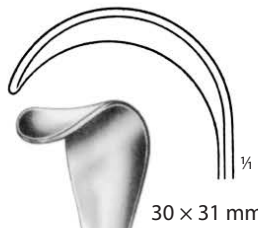

30 x 31 mm

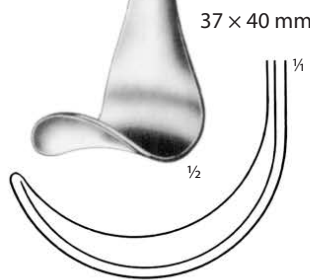

37 x 40 mm

**GOELET**  
**118 91 0316**  
19,0 cm

# 119

## ROZVĚRAČE RETRACTORS

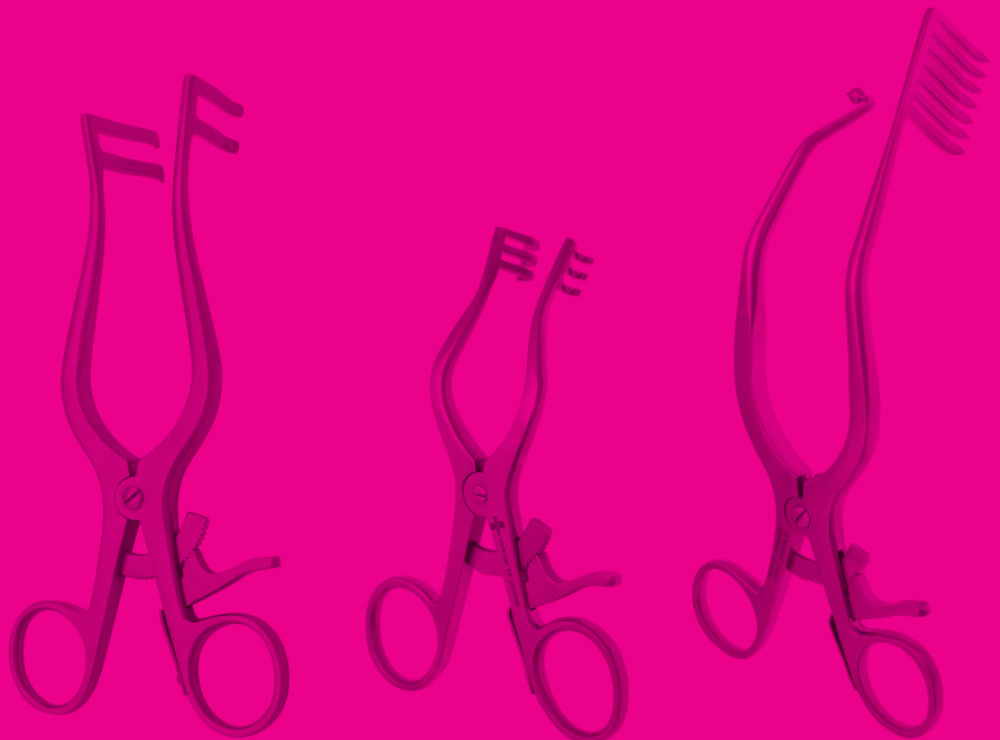

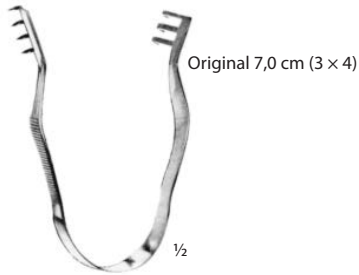

**FINSEN**

 ostrý  
 sharp

**119 91 0001** 5,0 cm (2 x 3)  
**119 91 0002** 7,0 cm (3 x 4)

 tupý  
 blunt

**119 91 0003** 5,0 cm (2 x 3)  
**119 91 0004** 7,0 cm (3 x 4)

 ostrý  
 sharp

**119 91 0005** 10,0 cm (4 x 4)

 tupý  
 blunt

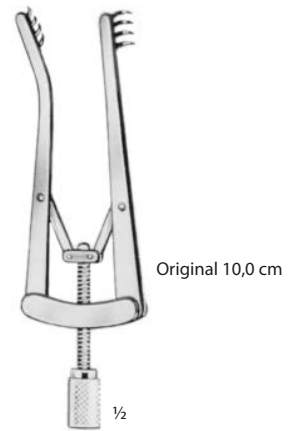
**119 91 0006** 10,0 cm (4 x 4)

**ALM**

 ostrý  
 sharp

**119 91 0007** 7,0 cm (4 x 4)  
**119 91 0008** 10,0 cm (4 x 4)

 tupý  
 blunt

**119 91 0009** 7,0 cm (4 x 4)  
**119 91 0010** 10,0 cm (4 x 4)

**JANSEN**

 ostrý  
 sharp

**119 91 0013** 10,0 cm (4 x 4)

 tupý  
 blunt

**119 91 0014** 10,0 cm (4 x 4)

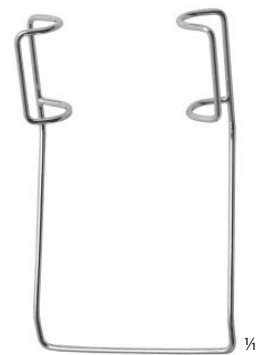
 Rozvěrač víček  
 Lids retractor  
**119 10 0100**  
 kojenecký  
 infantile  
 4,3 cm

 Rozvěrač víček  
 Lids retractor  
**119 38 0070**  
 mikro  
 micro  
 4,6 cm

ROZVĚRAČE RAN  
SELF-RETAINING RETRACTORS

Original 16,5 cm

ostrý sharp	tupý blunt		
<b>119 91 0020</b>	<b>119 91 0021</b>	10,5 cm	(2 × 3)
<b>119 08 1040</b>	<b>119 08 1060</b>	14,0 cm	(3 × 4)
<b>119 08 0680</b>	<b>119 08 0690</b>	16,5 cm	(3 × 4)
<b>119 91 0026</b>	<b>119 91 0027</b>	20,0 cm	(3 × 4)
<b>119 91 0028</b>	<b>119 91 0029</b>	25,0 cm	(3 × 4)
<b>119 91 0030</b>	<b>119 91 0031</b>	26,0 cm	(5 × 6)

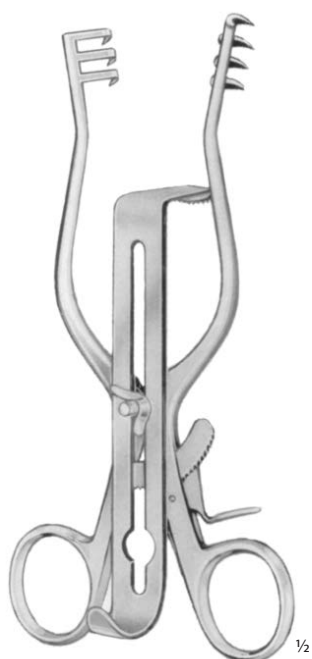
½

**WEITLANER**

½

**HENLEY**

ostrý sharp	tupý blunt	
<b>119 91 0032</b>	<b>119 91 0036</b>	16,5 cm (3 × 4)

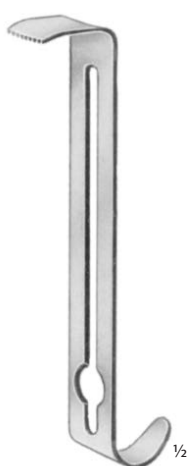

½

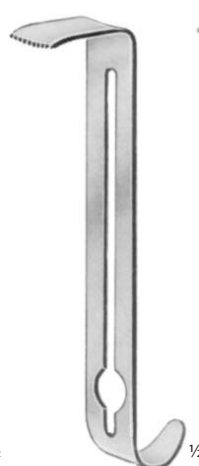
**119 91 0033**  
19 × 16 mm

½

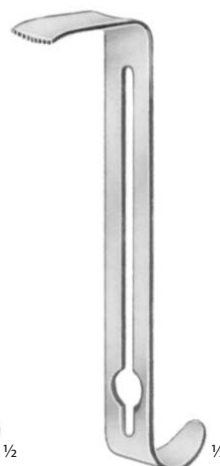
**119 91 0034**  
25 × 16 mm

½

**119 91 0035**  
32 × 16 mm



**ADSON**

ostrý	tupý		
sharp	blunt		
<b>119 91 0052</b>	<b>119 91 0053</b>	20,0 cm	(4 × 4)

**ANDERSON-ADSON**

ostrý	tupý		
sharp	blunt		
<b>119 91 0054</b>	<b>119 91 0055</b>	20,0 cm	(4 × 4)



Original 16,0 cm

**WULLSTEIN**

ostrý	tupý		
sharp	blunt		
<b>119 91 0042</b>	<b>119 91 0045</b>	10,5 cm	(3 × 3)
<b>119 91 0043</b>	<b>119 91 0046</b>	13,0 cm	(3 × 3)
<b>119 91 0044</b>	<b>119 91 0047</b>	16,0 cm	(3 × 3)

**MOLLISON**

ostrý	tupý		
sharp	blunt		
<b>119 91 0048</b>	<b>119 91 0049</b>	15,0 cm	(4 × 4)



**MISKIMON**

ostrý	tupý		
sharp	blunt		
<b>119 91 0050</b>	<b>119 91 0051</b>	22,0 cm	(7 × 7)

**CONE**

ostrý	tupý
sharp	blunt

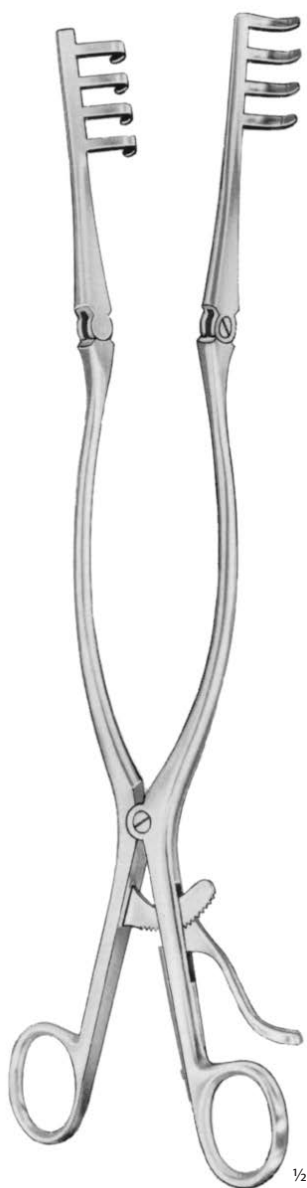
<b>119 91 0062</b>	<b>119 91 0066</b>	16,5 cm (3 × 4)
--------------------	--------------------	-----------------

**BECKMANN**

ostrý	tupý
sharp	blunt

<b>119 91 0069</b>	<b>119 91 0070</b>	31,0 cm (4 × 4)
--------------------	--------------------	-----------------

**BECKMANN-EATON**

ostrý	tupý
sharp	blunt

<b>119 91 0081</b>	<b>119 91 0082</b>	33,0 cm (7 × 7)
--------------------	--------------------	-----------------



**GELPI**  
**119 91 0085** 9,0 cm  
**119 91 0086** 11,0 cm  
**119 91 0087** 14,0 cm  
**119 91 0088** 19,0 cm



**GELPI**  
**119 91 0089**  
 19,0 cm



**DARLING**  
**119 91 0099**  
 18,0 cm  
 Fig. 1



**MARKHAM-MEYERDING**  
 pravý  
 right  
**119 91 0094**  
 18,0 cm  
 Fig. 1



**MARKHAM-MEYERDING**  
 levý  
 left  
**119 91 0095**  
 18,0 cm  
 Fig. 2



**DARLING**  
**119 91 0100**  
 18,0 cm  
 Fig. 2

ROZVĚRAČE RAN  
SELF-RETAINING RETRACTORS**PLESTER**pravý  
right**119 91 0103** 10,0 cm  
**119 91 0104** 13,0 cm**PLESTER**levý  
left**119 91 0105** 10,0 cm  
**119 91 0106** 13,0 cm**MAYO-ADAMS****119 91 0110**

17,0 cm

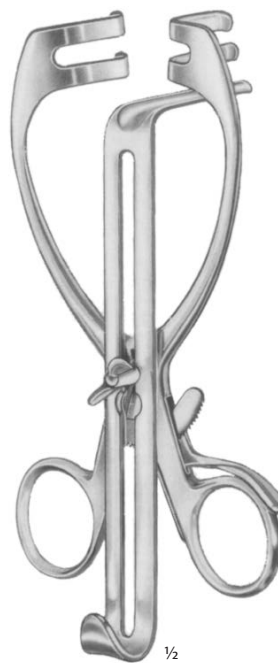
**MAYO-ADAMS****119 91 0111**

17,0 cm



**WALTON**  
**119 08 0610**  
pravý  
right  
19,5 cm



**WALTON**  
**119 08 0620**  
levý  
left  
19,5 cm



**ADSON**  
**119 08 0650**  
ostrý  
sharp  
(3 × 4)  
23,3 cm



ostrý  
sharp  
**119 08 1080**

tupý  
blunt  
**119 08 1090** 14,0 cm (3 × 3)



**119 08 1120**  
tupý  
blunt  
13,0 cm  
(3 × 4)

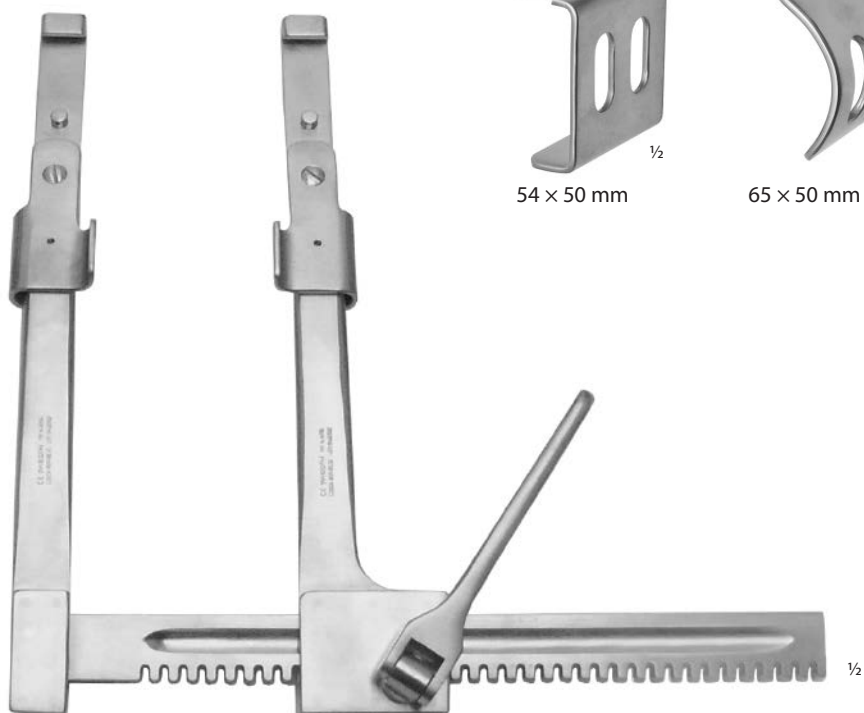
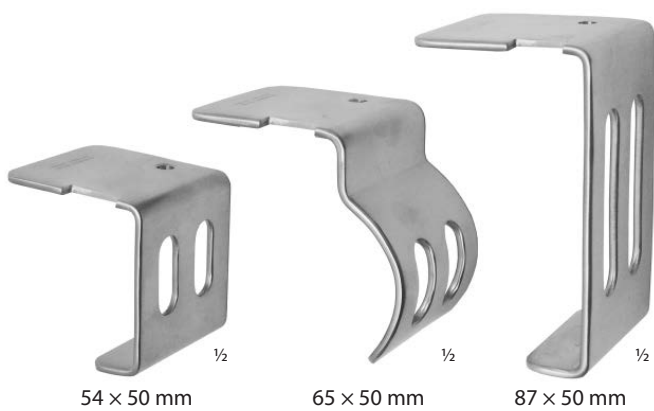
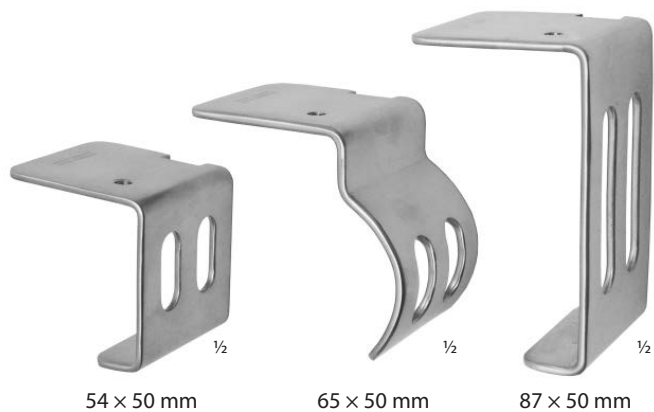

**FINOCHIETTO**  
**119 14 0050**  
sada  
set  
21,5 cm

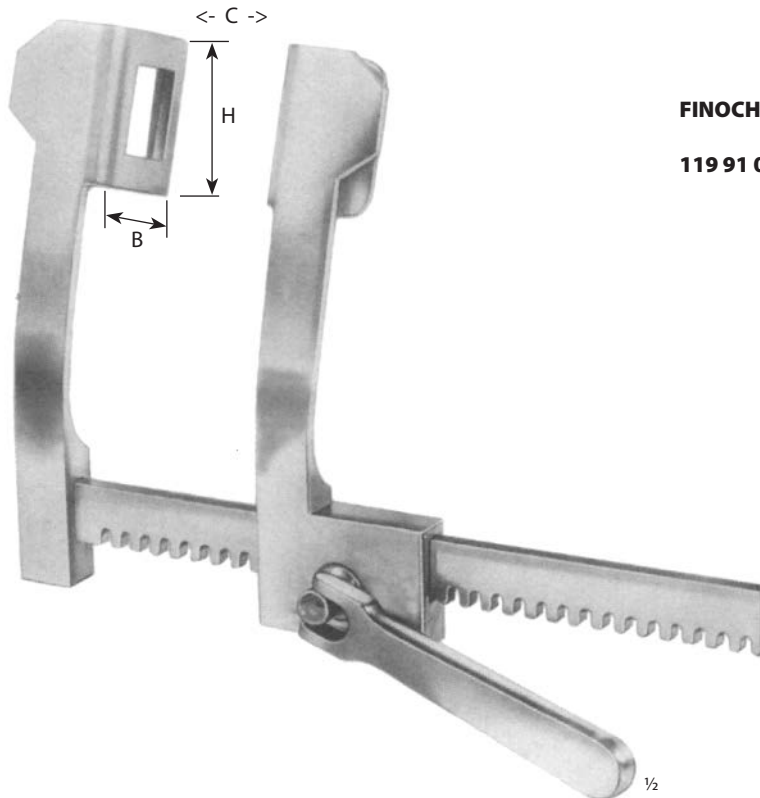

**FINOCHIETTO**

	B	H	C
<b>119 91 0245</b>	30 mm	45 mm	150 mm
<b>119 91 0246</b>	46 mm	62 mm	190 mm
<b>119 91 0247</b>	80 mm	65 mm	190 mm



**FINOCHIETTO-BABY**

	B	H	C
<b>119 91 0244</b>	14 mm	15 mm	75 mm

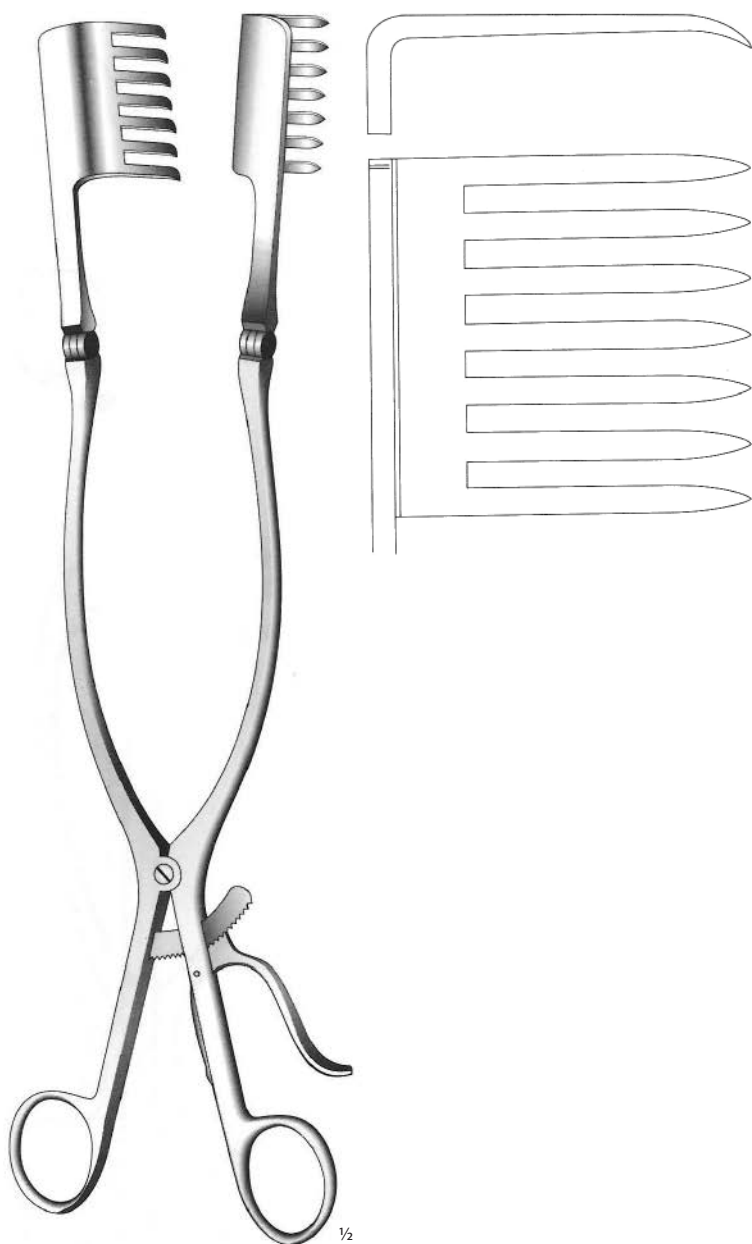

**119 17 0030**  
ostrý  
sharp  
(7 × 7)  
32,0 cm



**119 17 0060**  
tupý  
blunt  
(4 × 4)  
32,0 cm



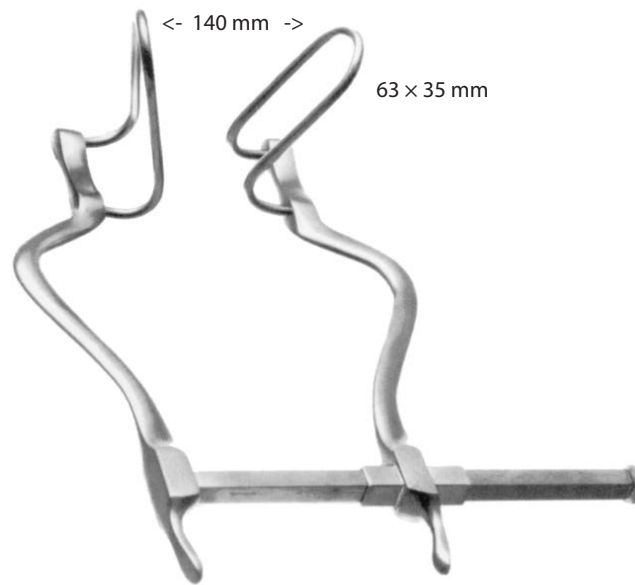

**GOSSET**  
**119 91 0118**



**GOSSET**  
**119 91 0119**

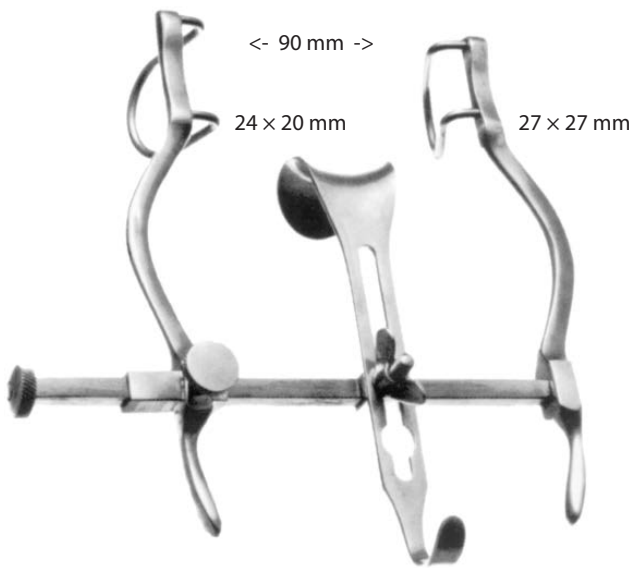

**BALFOUR-BABY**  
119 91 0123

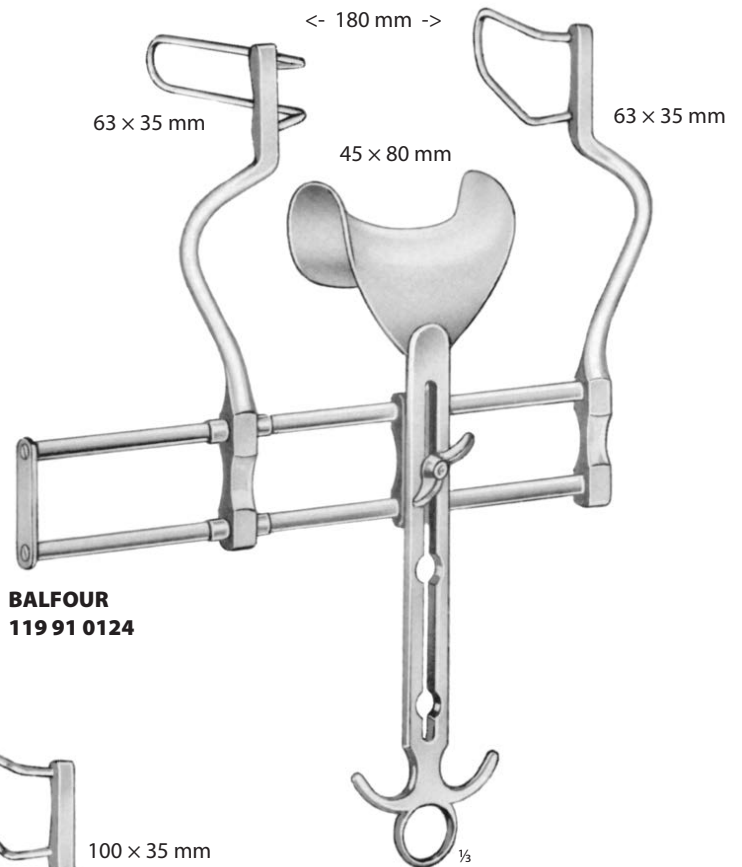

**BALFOUR**  
119 91 0124

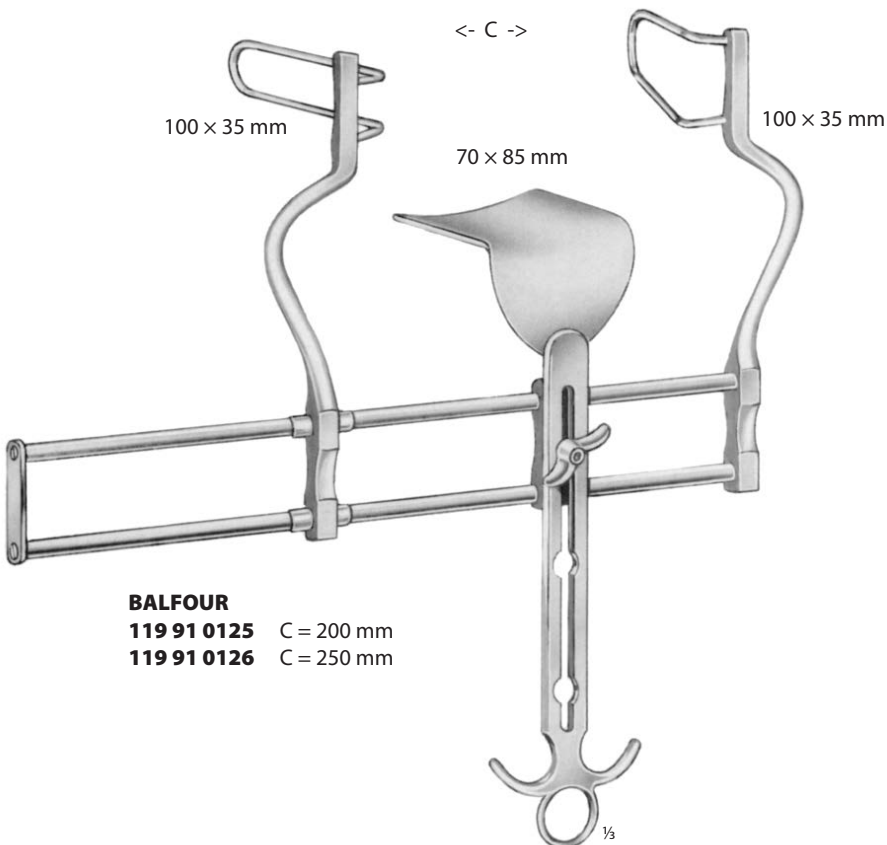

**BALFOUR**  
119 91 0125 C = 200 mm  
119 91 0126 C = 250 mm

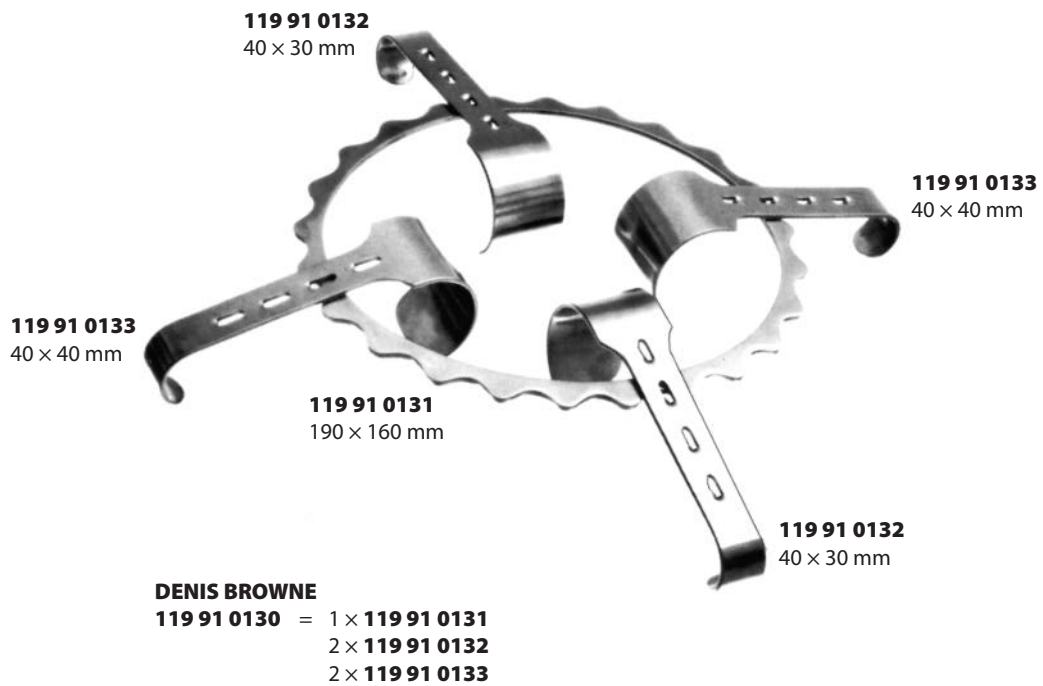

**119 91 0135**



**119 91 0136**  
110 × 70 mm



**119 91 0137**  
80 × 45 mm

**O'SULLIVAN-O'CONNOR**  
119 91 0134 = 1 × 119 91 0135  
1 × 119 91 0136  
2 × 119 91 0137

ROZVĚRAČE BŘIŠNÍ  
ABDOMINAL RETRACTORS

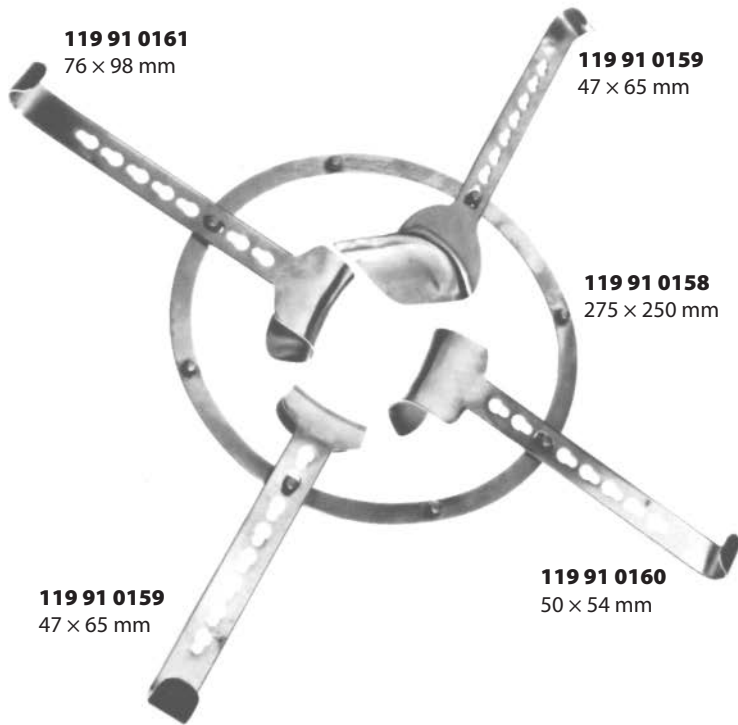

**119 91 0161**  
76 × 98 mm

**119 91 0159**  
47 × 65 mm

**119 91 0158**  
275 × 250 mm

**119 91 0159**  
47 × 65 mm

**119 91 0160**  
50 × 54 mm



**119 91 0162**  
98 × 52 mm



**119 91 0163**  
105 × 35 mm

**SEMM**

- 119 91 0157** = 1 × **119 91 0158**  
 2 × **119 91 0159**  
 1 × **119 91 0160**  
 1 × **119 91 0161**  
 1 × **119 91 0162**  
 1 × **119 91 0163**

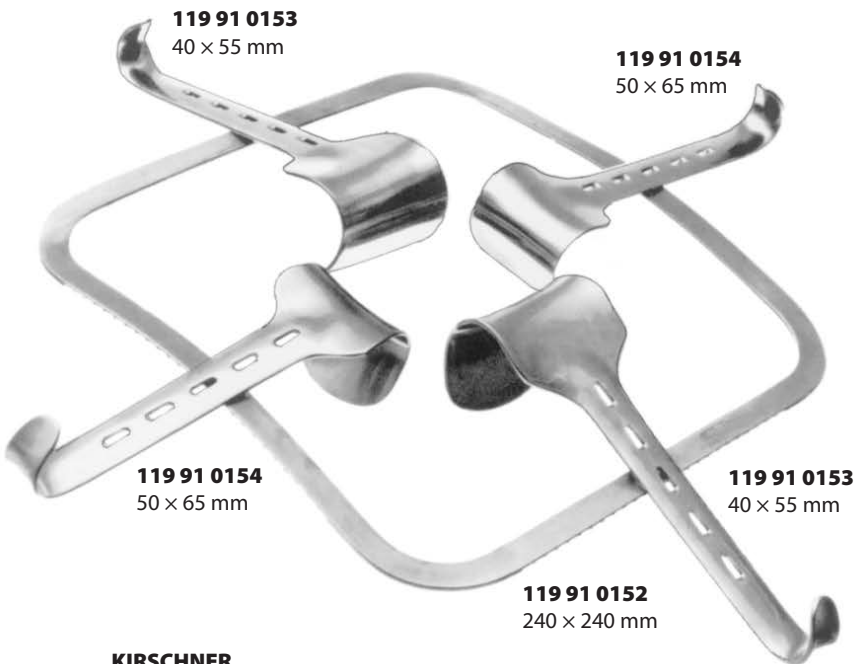

**119 91 0153**  
40 × 55 mm

**119 91 0154**  
50 × 65 mm

**119 91 0154**  
50 × 65 mm

**119 91 0153**  
40 × 55 mm

**119 91 0152**  
240 × 240 mm



**119 91 0155**  
78 × 65 mm



**119 91 0156**  
80 × 90 mm

**KIRSCHNER**

- 119 91 0151** = 1 × **119 91 0152**  
 2 × **119 91 0153**  
 2 × **119 91 0154**

**119 91 0143**  
300 × 300 mm

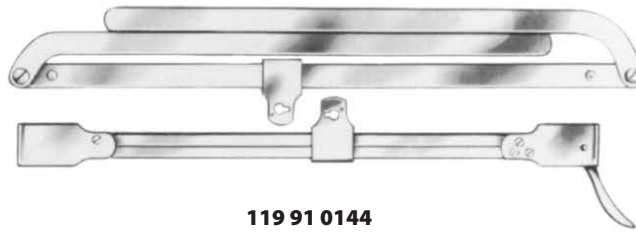

**119 91 0144**  
38 × 60 mm



**119 91 0145**  
50 × 65 mm

**119 91 0145**  
50 × 65 mm

**119 91 0144**  
38 × 60 mm

**FRANZ**  
**119 91 0142** = 1 × **119 91 0143**  
2 × **119 91 0144**  
2 × **119 91 0145**

**119 91 0147**  
45 × 80 mm



**119 91 0148**  
60 × 85 mm

**119 91 0148**  
60 × 85 mm

**119 91 0147**  
45 × 80 mm

**FRANZ**  
**119 91 0146** = 1 × **119 91 0143**  
2 × **119 91 0144**  
2 × **119 91 0145**  
2 × **119 91 0147**  
2 × **119 91 0148**



**119 91 0149**  
105 × 35 mm



**119 91 0150**  
98 × 50 mm

**119 91 0166**  
30 × 44 mm



**COLLIN-BABY**  
**119 91 0164**  
komplet  
complete  
18,0 cm

**119 91 0165**  
23 × 44 mm

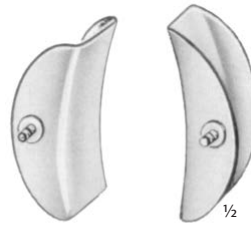

**COLLIN**  
**119 91 0169**  
22,0 cm

32 × 62 mm

38 × 62 mm

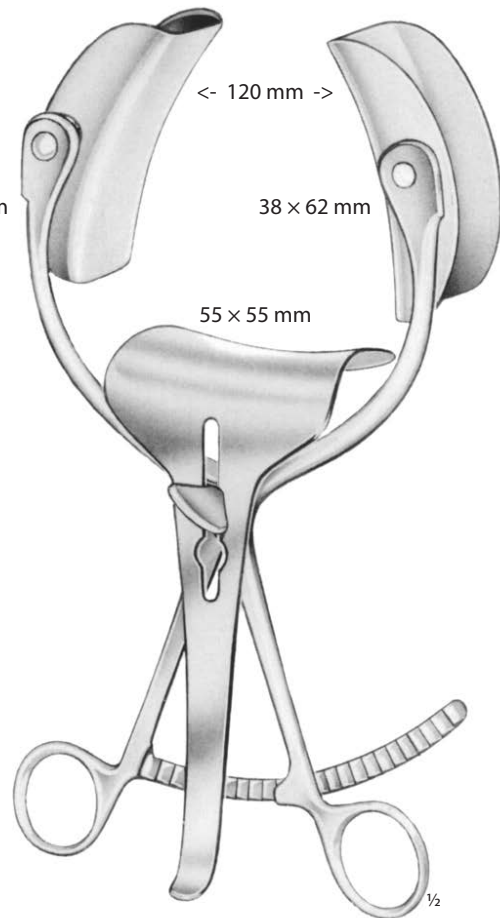

**COLLIN**  
**119 91 0170**  
22,0 cm

<- 120 mm ->

38 × 62 mm

55 × 55 mm

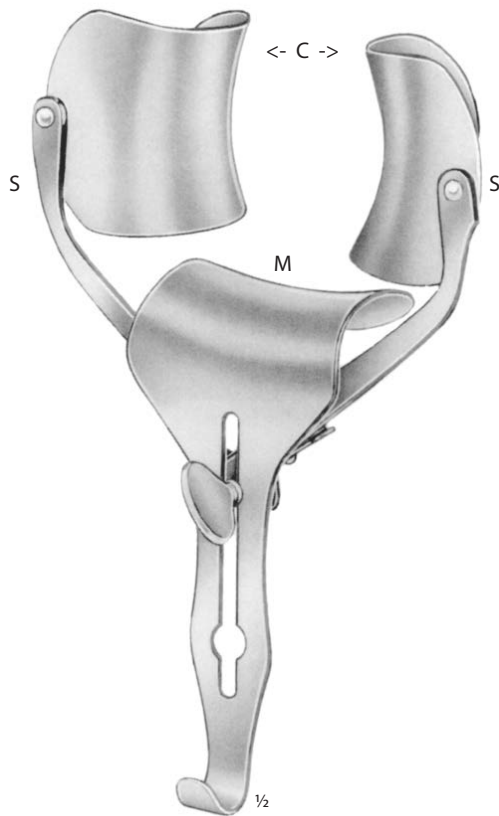
**RICARD**

	S	M	C
<b>119 91 0173</b>	72 × 85 mm	80 × 90 mm	280 mm
<b>119 91 0174</b>	60 × 80 mm	55 × 70 mm	300 mm

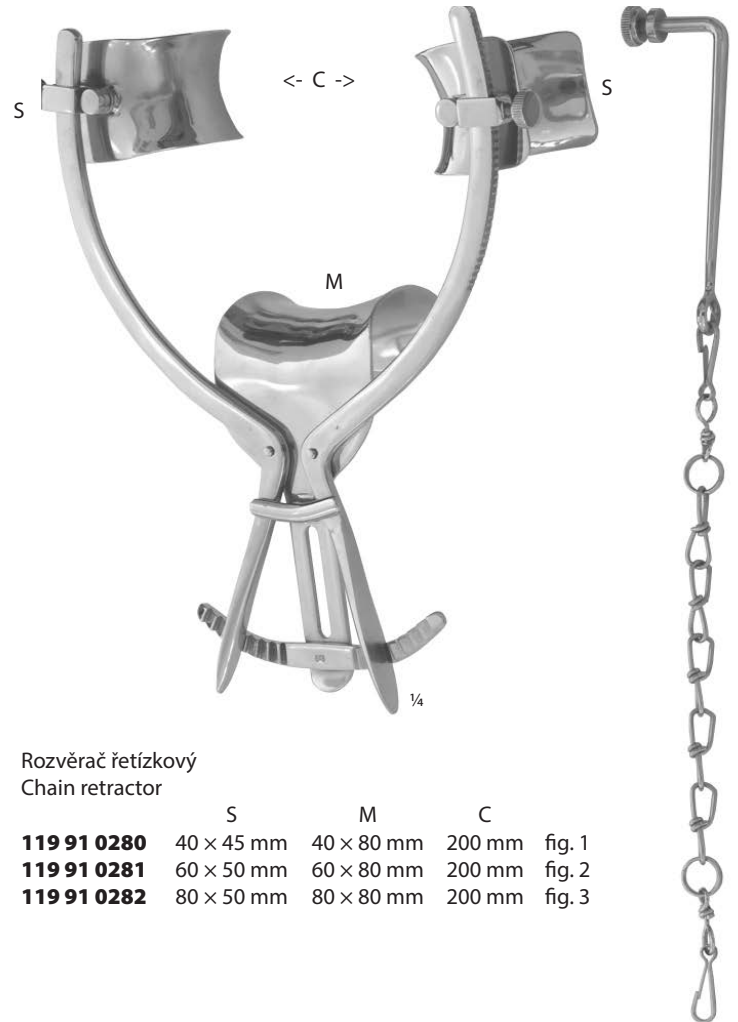
**Rozvěrač řetězkový**  
**Chain retractor**

	S	M	C	
<b>119 91 0280</b>	40 × 45 mm	40 × 80 mm	200 mm	fig. 1
<b>119 91 0281</b>	60 × 50 mm	60 × 80 mm	200 mm	fig. 2
<b>119 91 0282</b>	80 × 50 mm	80 × 80 mm	200 mm	fig. 3

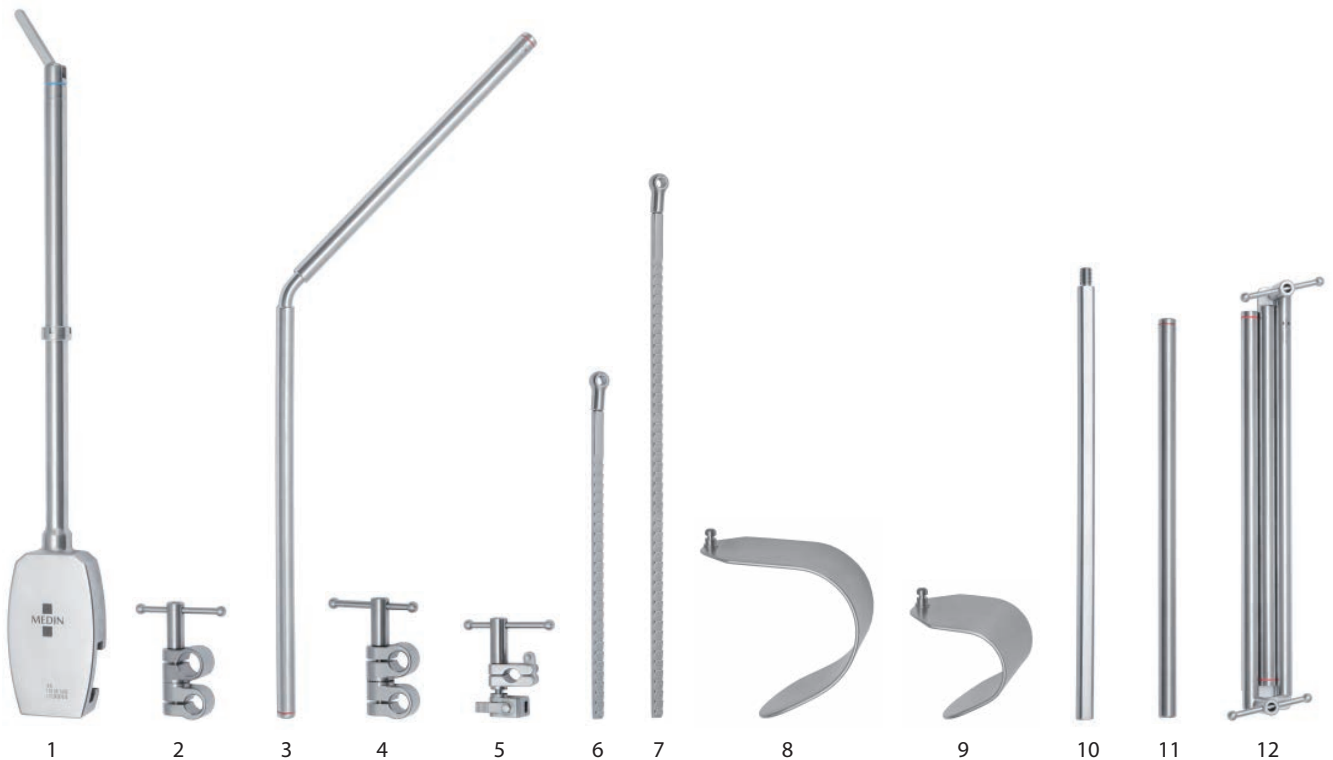
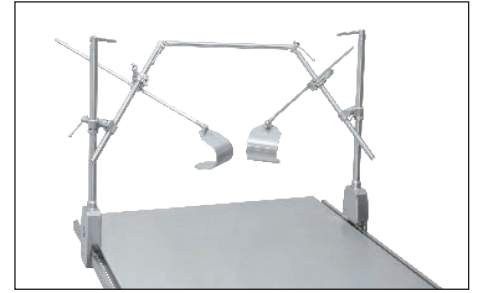
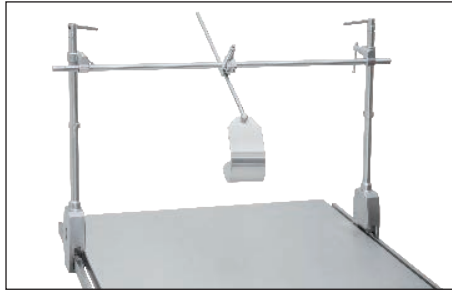
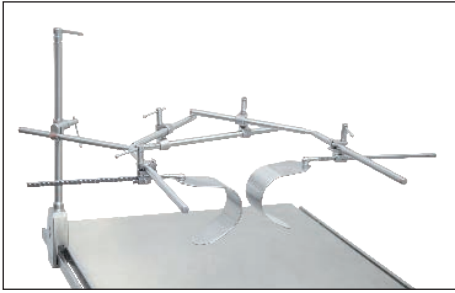
ROZVĚRAČ BŘÍŠNÍ UNIVERZÁLNÍ  
UNIVERSAL ABDOMINAL RETRACTOR**119 08 1620** Rozvěrač břišní univerzální

## Universal abdominal retractor

- |    |                    |                           |
|----|--------------------|---------------------------|
| 1  | <b>119 08 1430</b> | Základna rozvěrače        |
| 2  | <b>119 08 1440</b> | Třmen základny            |
| 3  | <b>119 08 1460</b> | Tyč spojovací             |
| 4  | <b>119 08 1470</b> | Třmen spojovací           |
| 5  | <b>119 08 1480</b> | Třmen háku                |
| 6  | <b>119 08 1490</b> | Rameno háku, 25 cm        |
| 7  | <b>119 08 1640</b> | Rameno háku dlouhé; 40 cm |
| 8  | <b>119 08 1500</b> | Hák rádiusový; L=120 mm   |
| 9  | <b>119 08 1510</b> | Hák rádiusový; L=80 mm    |
| 10 | <b>119 08 1560</b> | Tyč spojovací 1           |
| 11 | <b>119 08 1570</b> | Tyč spojovací 2           |
| 12 | <b>119 08 1630</b> | Hrazda                    |

- |                                 |        |
|---------------------------------|--------|
| Retractor base                  | ks/pcs |
| Base clamp (tube-to-tube clamp) | 2      |
| Connecting horizontal rod       | 2      |
| Connecting clamp                | 3      |
| Hook clamp                      | 2      |
| Hook arm; 25 cm                 | 2      |
| Hook arm long; 40 cm            | 2      |
| Hook; L=120 mm                  | 2      |
| Hook; L=80 mm                   | 2      |
| Connecting horizontal rod 1     | 1      |
| Connecting horizontal rod 2     | 1      |
| Horizontal bar                  | 1      |

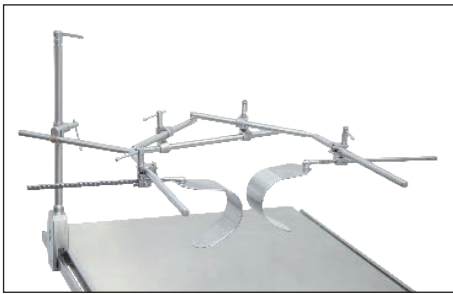

**119 08 1600** Rozvěrač břišní

- |   |                    |                         |
|---|--------------------|-------------------------|
| 1 | <b>119 08 1430</b> | Základna rozvěrače      |
| 2 | <b>119 08 1440</b> | Třmen základny          |
| 3 | <b>119 08 1460</b> | Tyč spojovací           |
| 4 | <b>119 08 1470</b> | Třmen spojovací         |
| 5 | <b>119 08 1480</b> | Třmen háku              |
| 6 | <b>119 08 1490</b> | Rameno háku; 25 cm      |
| 8 | <b>119 08 1500</b> | Hák rádiusový; L=120 mm |
| 9 | <b>119 08 1510</b> | Hák rádiusový; L=80 mm  |

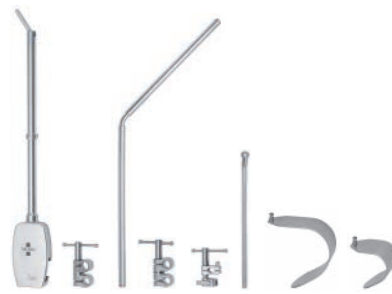

Abdominal retractor

- |                                 |   |
|---------------------------------|---|
| Retractor base                  | 1 |
| Base clamp (tube-to-tube clamp) | 1 |
| Connecting horizontal rod       | 3 |
| Connecting clamp                | 2 |
| Hook clamp                      | 2 |
| Hook arm; 25 cm                 | 2 |
| Hook; L=120 mm                  | 2 |
| Hook; L=80 mm                   | 2 |

ks/pcs
1
1
3
2
2
2
2
2

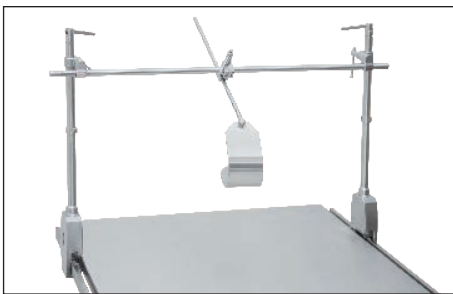
**119 08 1610** Rozvěrač Rochard

- |    |                    |                         |
|----|--------------------|-------------------------|
| 1  | <b>119 08 1430</b> | Základna rozvěrače      |
| 2  | <b>119 08 1440</b> | Třmen základny          |
| 10 | <b>119 08 1560</b> | Tyč spojovací 1         |
| 11 | <b>119 08 1570</b> | Tyč spojovací 2         |
| 5  | <b>119 08 1480</b> | Třmen háku              |
| 6  | <b>119 08 1490</b> | Rameno háku; 25 cm      |
| 8  | <b>119 08 1500</b> | Hák rádiusový; L=120 mm |
| 9  | <b>119 08 1510</b> | Hák rádiusový; L=80 mm  |



Rochard abdominal retractor

- |                                 |   |
|---------------------------------|---|
| Retractor base                  | 2 |
| Base clamp (tube-to-tube clamp) | 2 |
| Connecting horizontal rod 1     | 1 |
| Connecting horizontal rod 2     | 1 |
| Hook clamp                      | 1 |
| Hook arm; 25 cm                 | 1 |
| Hook; L=120 mm                  | 1 |
| Hook; L=80 mm                   | 1 |

ks/pcs
2
2
1
1
1
1
1
1

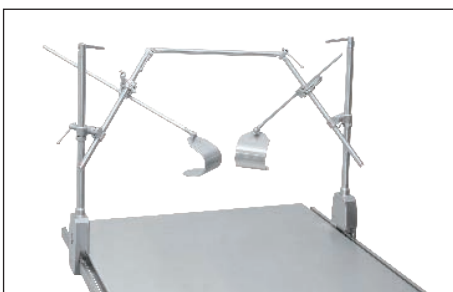
**119 08 1590** Rozvěrač žeberního oblouku

- |    |                    |                           |
|----|--------------------|---------------------------|
| 1  | <b>119 08 1430</b> | Základna rozvěrače        |
| 2  | <b>119 08 1440</b> | Třmen základny            |
| 12 | <b>119 08 1630</b> | Hrazda                    |
| 5  | <b>119 08 1480</b> | Třmen háku                |
| 7  | <b>119 08 1640</b> | Rameno háku dlouhé; 40 cm |
| 6  | <b>119 08 1510</b> | Hák rádiusový; L=80 mm    |



Costal arch abdominal retractor

- |                                 |   |
|---------------------------------|---|
| Retractor base                  | 2 |
| Base clamp (tube-to-tube clamp) | 2 |
| Horizontal bar                  | 1 |
| Hook clamp                      | 2 |
| Hook arm long; 40 cm            | 2 |
| Hook; L=80 mm                   | 2 |

ks/pcs
2
2
1
2
2
2



PERCY  
119 91 0184

# 121

## LOPATKY SPATULAS

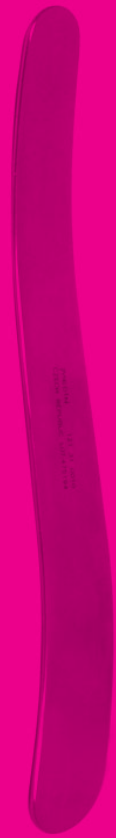
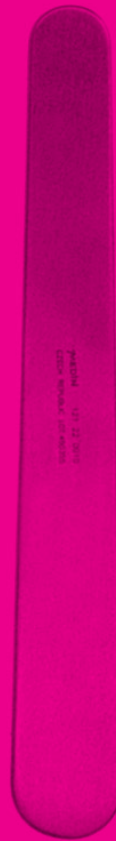





**REVERDIN**  
**121 91 0012**  
29,0 cm  
45/60 mm



Lopatka břišní  
Abdominal spatula  
**121 08 0050**  
33,0 cm  
ohebná  
malleable  
40 mm



Original 32,0 cm

**ALLISON**  
**121 91 0027**  
26,0 cm  
  
**121 91 0028**  
32,0 cm



1/2

Lopátka na masť  
Unguent spatula  
**121 08 0100**  
14,0 cm  
13/16 mm



1/2

**TUFFIER**  
**121 22 0010**  
ohébná  
maleable  
17,5 cm  
16/23 mm



1/2

**JAEGER**  
**121 38 0010**  
11,0 cm

# 122

## ZRCADLA SPECULA

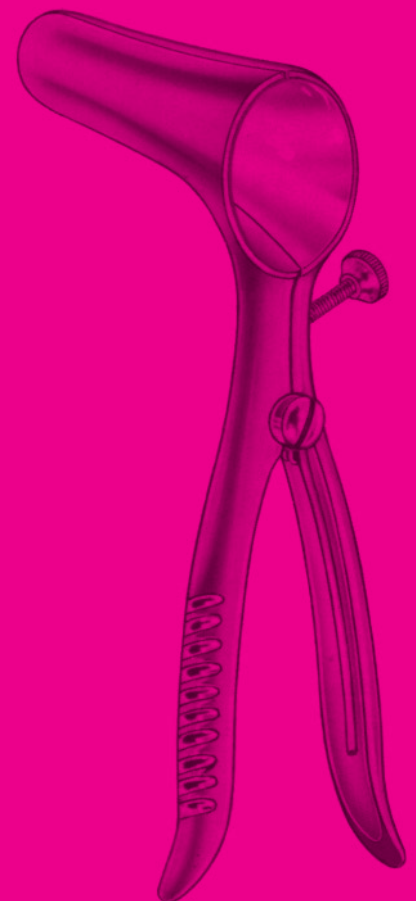
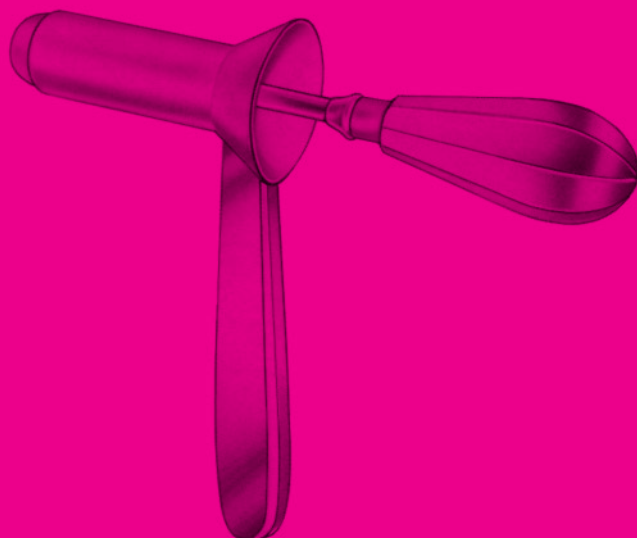





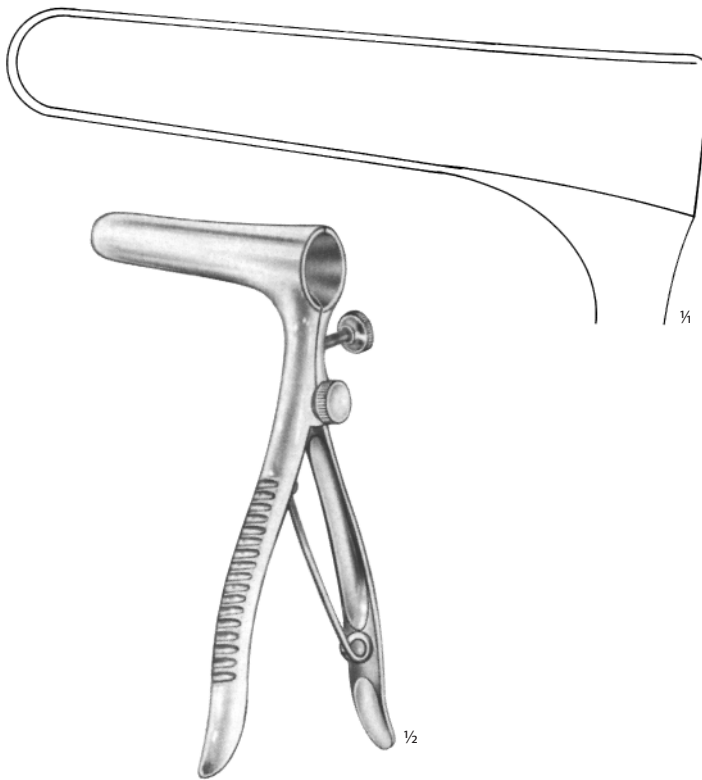

**SIMS**  
**122 91 0365**  
15,0 cm



**SIMS**  
**122 91 0366**  
15,0 cm



**PRATT**  
**122 91 0371**  
21,5 cm  
85 x 25 mm



**IVES-FANSLER**  
**122 91 0382**  
ø 22 mm



**HIRSCHMANN**  
**122 91 0385** ø 16 mm × 65 mm  
**122 91 0386** ø 19 mm × 65 mm  
**122 91 0387** ø 22 mm × 65 mm  
**122 91 0388** ø 22 mm × 125 mm



**BENSAUDE**  
**122 91 0394** ø 19 mm × 70 mm  
**122 91 0395** ø 22 mm × 70 mm

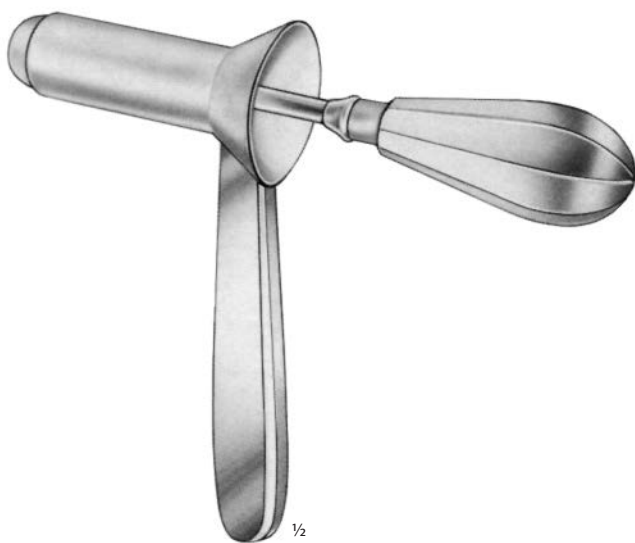

**KELLY**  
**122 91 0396** ø 22 mm × 50 mm  
**122 91 0397** ø 22 mm × 100 mm  
**122 91 0398** ø 22 mm × 140 mm  
**122 91 0399** ø 22 mm × 200 mm



**KELLY**  
**122 91 0400** ø 21 mm × 50 mm  
**122 91 0401** ø 27 mm × 50 mm

# 123

## PÁČIDLA ELEVATORS

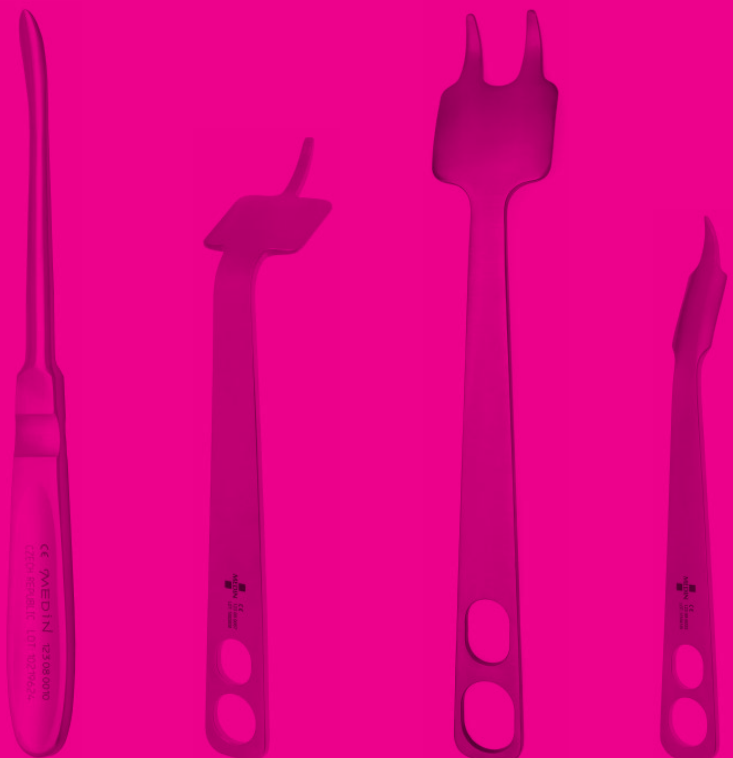





**LANGENBECK**  
20,0 cm

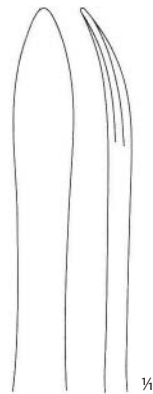

**123 08 0010**  
8 mm

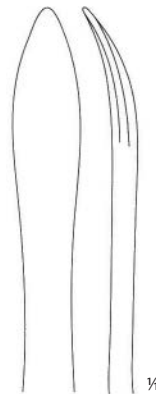

**123 08 0020**  
10 mm

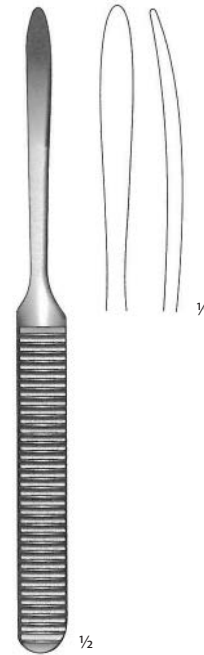

**WILLIGER**  
**123 08 0030**  
16,0 cm

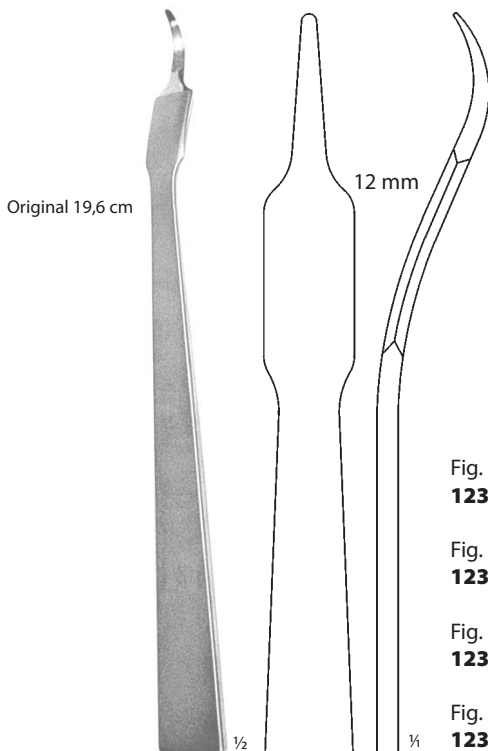

**HOHMANN**  
přímé  
straight  
12 mm

Fig. 1  
**123 09 0300** tupé blunt 14,0 cm

Fig. 2  
**123 09 0310** tupé blunt 19,6 cm

Fig. 1  
**123 09 0320** ostré sharp 14,0 cm

Fig. 2  
**123 09 0330** ostré sharp 19,6 cm

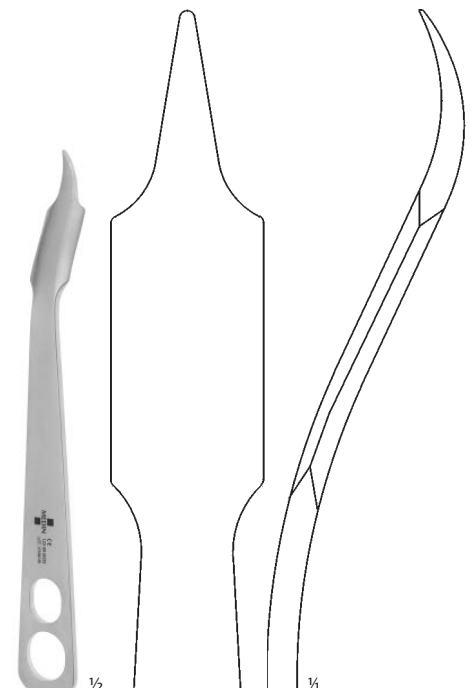

**123 99 0033**  
úzké ostré  
narrow sharp  
24,0 cm  
20 mm

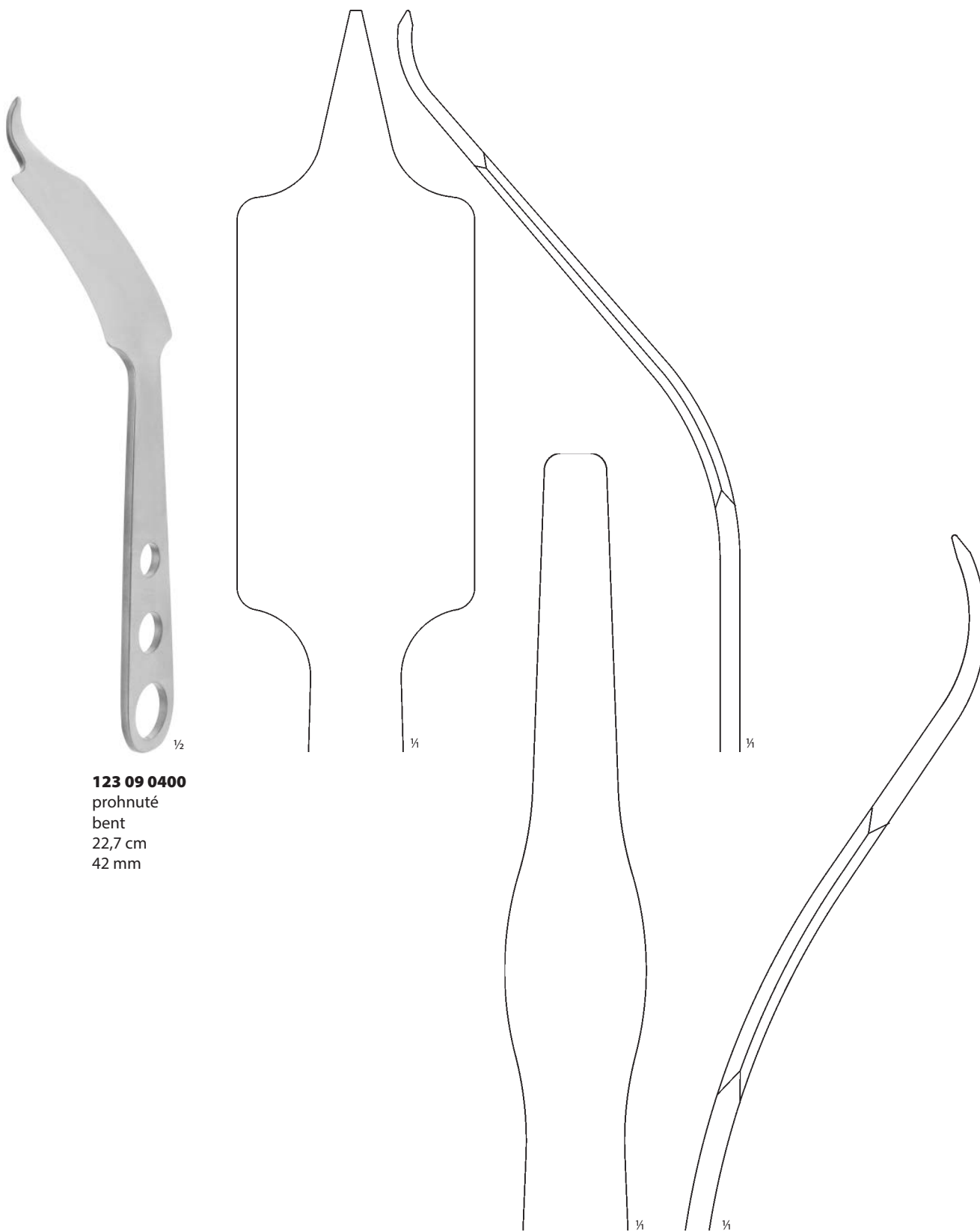

**123 09 0400**  
prohnuté  
bent  
22,7 cm  
42 mm

**123 99 0097**  
tupé  
blunt  
27,7 cm  
25 mm

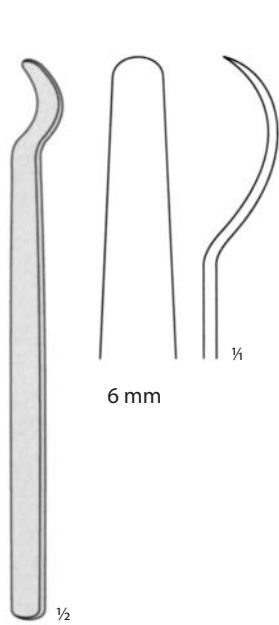

**123 91 0030**  
14,0 cm

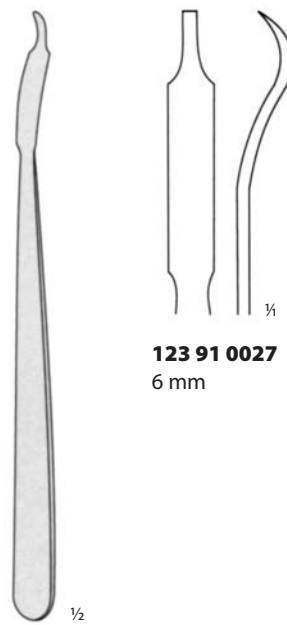

**123 91 0027**  
6 mm

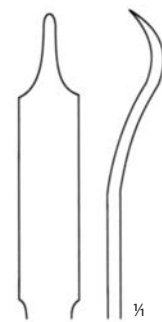

**123 91 0028**  
8 mm

**MINI-HOHMANN**  
16,0 cm

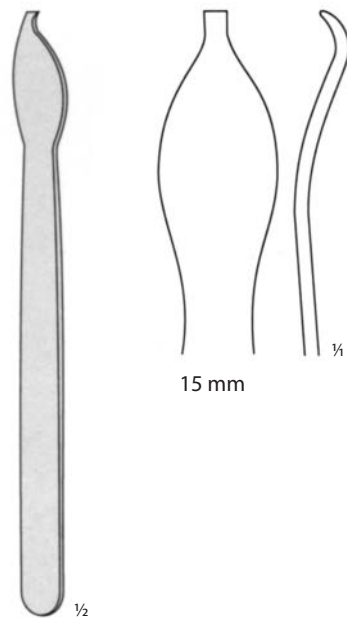

**123 91 0031**  
17,0 cm

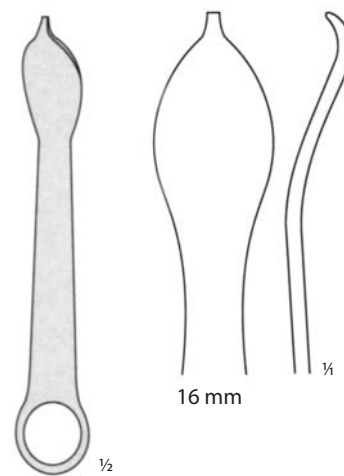

**123 91 0032**  
12,0 cm

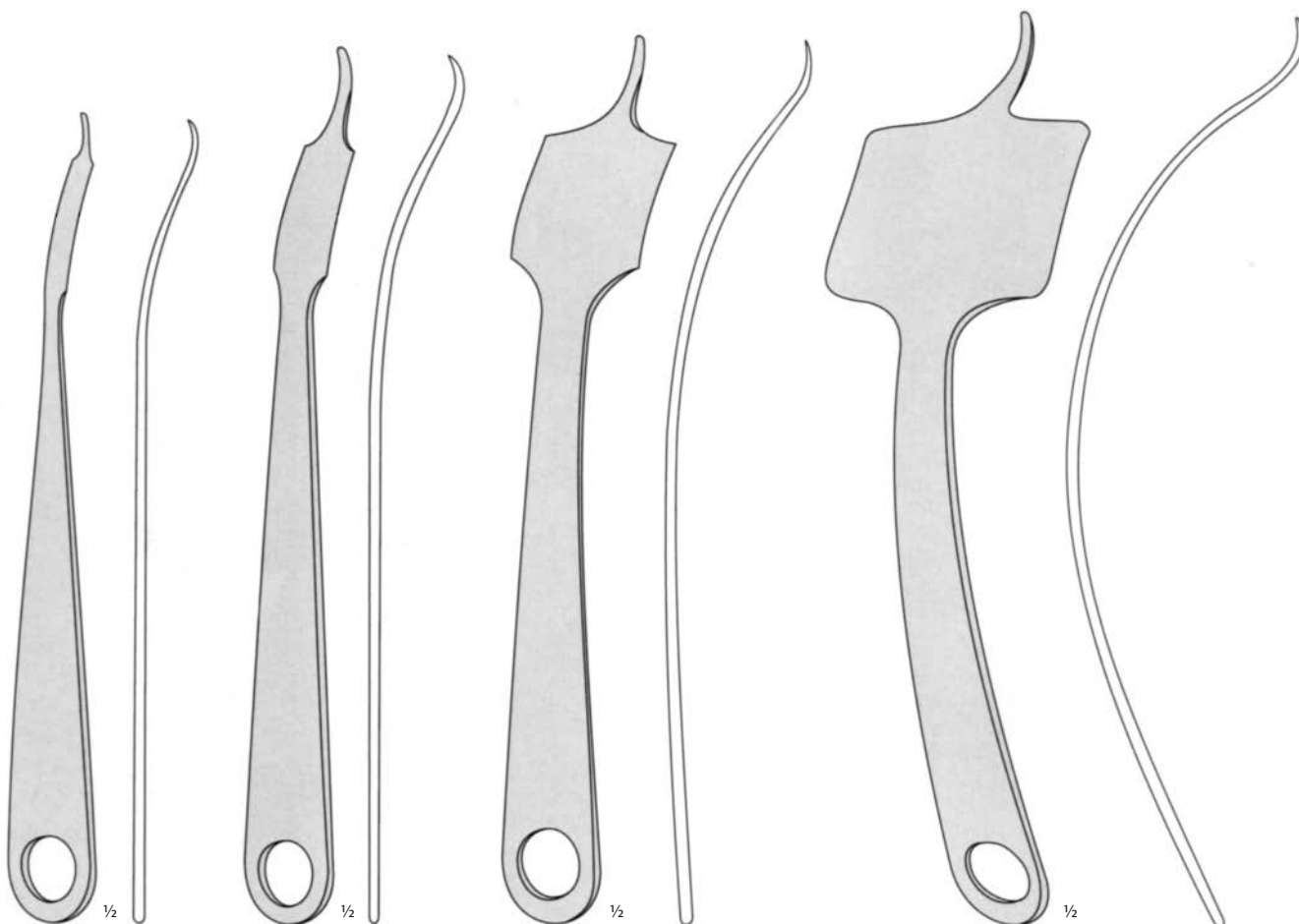

**HOHMANN**  
**123 91 0033**  
22,0 cm  
8 mm

**HOHMANN**  
**123 91 0034**  
24,0 cm  
18 mm

**HOHMANN**  
**123 91 0035**  
24,0 cm  
43 mm

**HOHMANN**  
**123 91 0036**  
25,0 cm  
70 mm



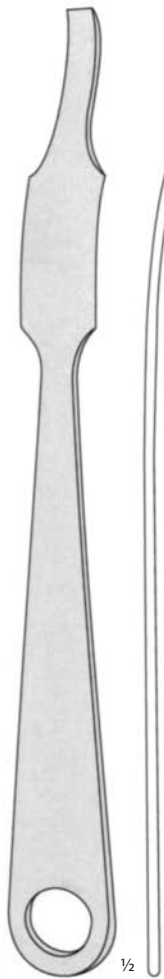

**HOHMANN**  
**123 91 0037**  
25,0 cm  
22 mm

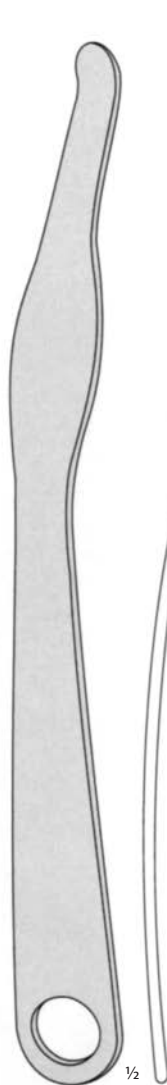

**123 91 0026**  
28,0 cm  
24 mm



**HOHMANN**  
**123 91 0029**  
29,0 cm  
33 mm

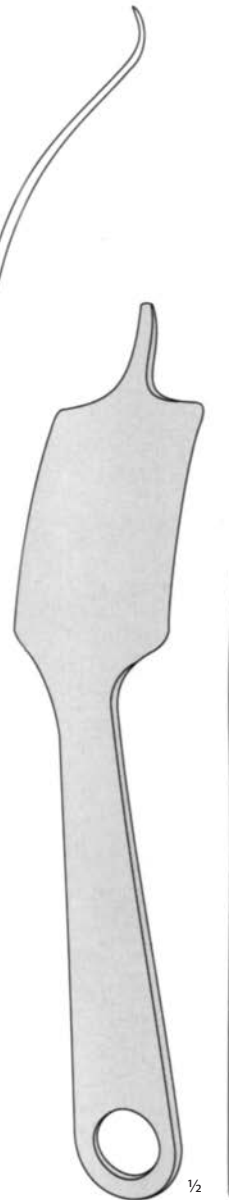

**HOHMANN**  
**123 91 0038**  
25,0 cm  
43 mm

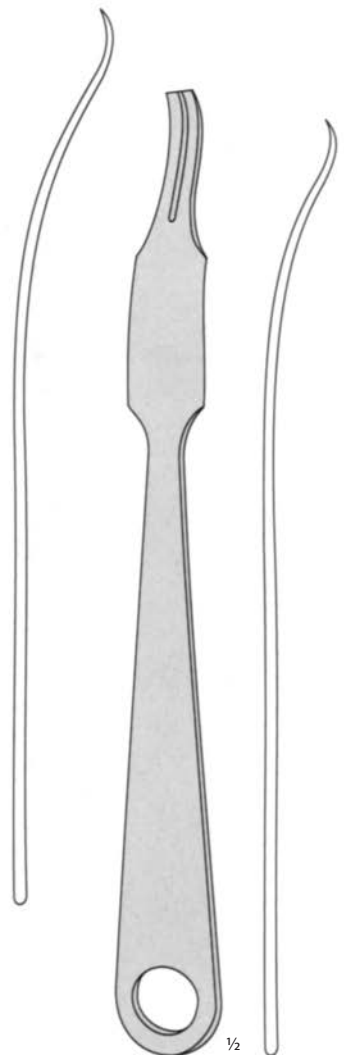

**LANGE-HOHMANN**  
**123 91 0039**  
26,0 cm  
22 mm



**BLOUNT**  
**123 91 0040**  
26,0 cm



**BLOUNT**  
**123 91 0041**  
26,0 cm

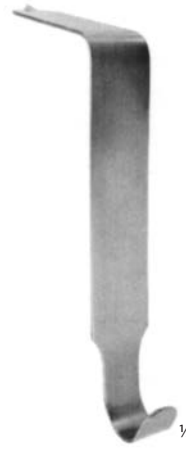

**TAYLOR**  
16,5 cm

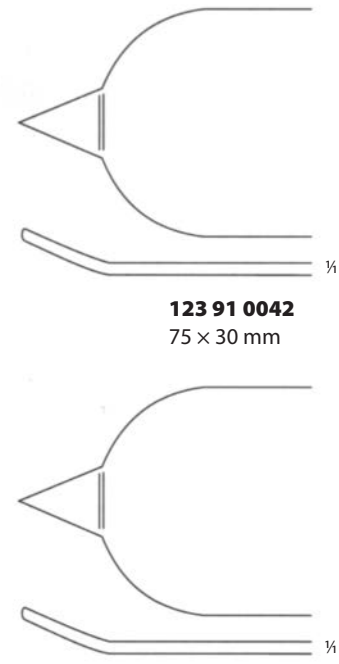

**123 91 0042**  
75 × 30 mm

**123 91 0043**  
100 × 30 mm

# 124

## ŠKRABKY RASPATORIES







**WILLIGER**  
16,0 cm

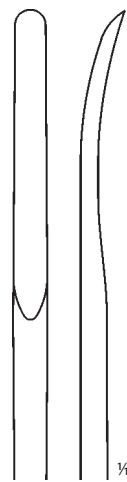

**124 08 0290**  
16,0 cm  
4 mm

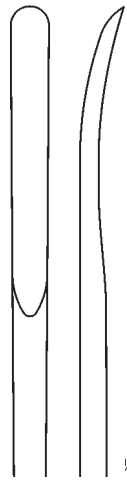

**124 08 0250**  
16,0 cm  
5 mm

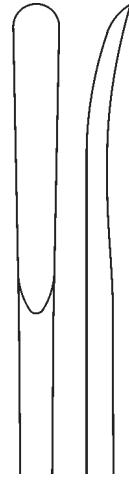

**124 08 0111**  
16,0 cm  
6 mm



**124 08 0280**  
16,0 cm  
3,5 mm

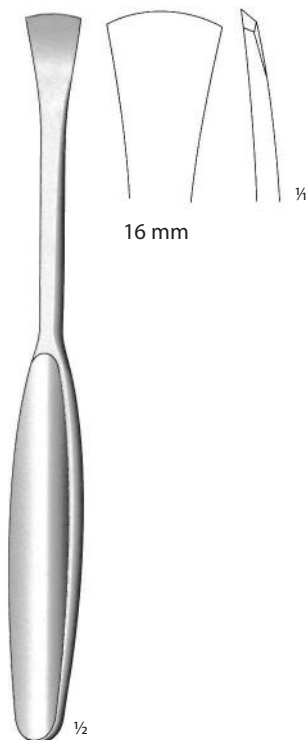

**LANGENBECK**  
**124 08 0120**  
19,0 cm

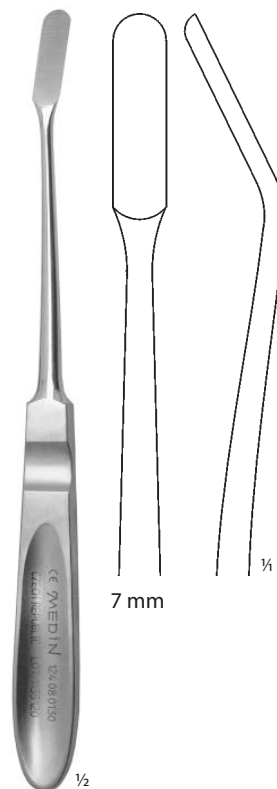

**LANGENBECK**  
**124 08 0130**  
20,4 cm

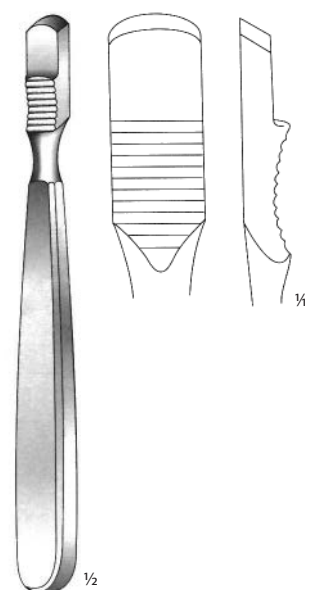

**FARABEUF**  
**124 08 0170**  
rovná  
straight  
15,0 cm

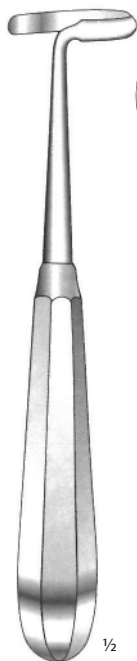

**DOYEN**  
17,0 cm



**124 14 0181**  
pravá  
right

**124 14 0191**  
levá  
left



**124 10 0111**  
pravá  
right

**124 10 0101**  
levá  
left



**OLLIER**  
124 14 0050 ÷ 124 14 0070



12 mm

**124 14 0050**  
22,6 cm

**124 14 0051**  
23,1 cm



16 mm

**124 14 0060**  
22,6 cm

**124 14 0061**  
23,1 cm



18 mm

**124 14 0070**  
22,6 cm

**124 14 0071**  
23,1 cm



**OLLIER**  
124 14 0051 ÷ 124 14 0071

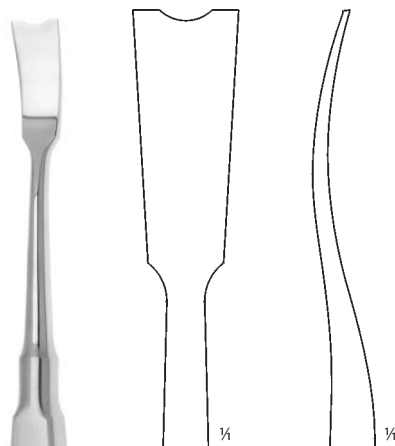

14 mm



**OLLIER**  
**124 14 0110**  
19,3 cm



**OLLIER**  
**124 14 0111**  
19,8 cm



12 mm



**SAUERBRUCH**  
**124 14 0040**  
19,0 cm

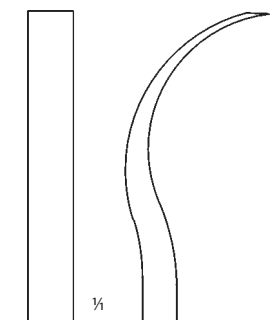

6 mm



**124 14 0130**  
20,0 cm



Škrabka na rohovku  
Corneal scarifier  
**124 38 0070**  
12,5 cm

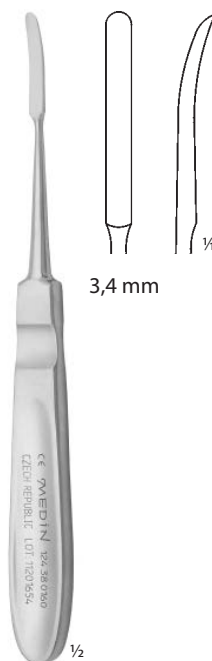

**124 38 0160**  
17,2 cm



# 125

## LŽIČKY SPOONS







Original 3,5 mm



**125 08 0110**  
17,0 cm  
Fig. 000  
3,5 mm



**125 08 0120**  
17,2 cm  
Fig. 0  
4,8 mm



**125 08 0130**  
17,5 cm  
Fig. 1  
6,0 mm



**125 08 0140**  
17,7 cm  
Fig. 3  
8,5 mm



**125 08 0150**  
18,4 cm  
Fig. 5  
12,0 mm



Original 4,0 mm



**125 08 0160**  
16,5 cm  
Fig. 1  
3,0 mm



**125 08 0170**  
16,5 cm  
Fig. 2  
3,5 mm



**125 08 0180**  
17,5 cm  
Fig. 3  
4,0 mm



**125 08 0190**  
17,5 cm  
Fig. 4  
5,0 mm



**125 08 0200**  
19,5 cm  
Fig. 5  
6,0 mm



**125 08 0210**  
19,5 cm  
Fig. 6  
6,7 mm



**VOLKMANN**  
17,0 cm



**67-724-000**  
Fig. 0000



**67-724-001**  
Fig. 000



**67-724-002**  
Fig. 00



**67-724-003**  
Fig. 0



**67-724-010**  
Fig. 1



**67-724-020**  
Fig. 2

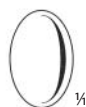

**67-724-030**  
Fig. 3



**67-724-040**  
Fig. 4



**67-724-050**  
Fig. 5



**67-724-060**  
Fig. 6



**SCHEDE**  
17,0 cm



**67-720-001**  
Fig. 000



**67-720-002**  
Fig. 00



**67-720-003**  
Fig. 0



**67-720-010**  
Fig. 1



**67-720-020**  
Fig. 2



**67-720-030**  
Fig. 3



**67-720-040**  
Fig. 4



**SPRATT**  
17,0 cm



**67-732-004**  
Fig. 0000



**67-732-001**  
Fig. 000



**67-732-002**  
Fig. 00



**67-732-003**  
Fig. 0



**67-732-010**  
Fig. 1



**67-732-020**  
Fig. 2



**67-732-030**  
Fig. 3



**67-732-040**  
Fig. 4



**67-732-050**  
Fig. 5



**BRUNS**  
16,0 cm



**67-728-001**  
Fig. 000



**67-728-002**  
Fig. 00



**67-728-003**  
Fig. 0



**67-728-010**  
Fig. 1



**67-728-020**  
Fig. 2



**67-728-030**  
Fig. 3



**67-728-040**  
Fig. 4



**67-728-050**  
Fig. 5



**67-728-060**  
Fig. 6



**LUER-KOERTE**  
32,0 cm



**VOLKMANN**  
**125 08 0310**  
13,0 cm



**125 91 0148**  
fig. 000  
2,5 mm



**125 91 0149**  
fig. 00  
3,2 mm



**125 91 0150**  
fig. 0  
4,2 mm



**125 91 0151**  
fig. 1  
5,5 mm



**125 91 0152**  
fig. 2  
6,7 mm



**125 91 0153**  
fig. 3  
8,0 mm



**125 91 0154**  
fig. 4  
11,0 mm



**125 91 0155**  
fig. 5  
15,0 mm

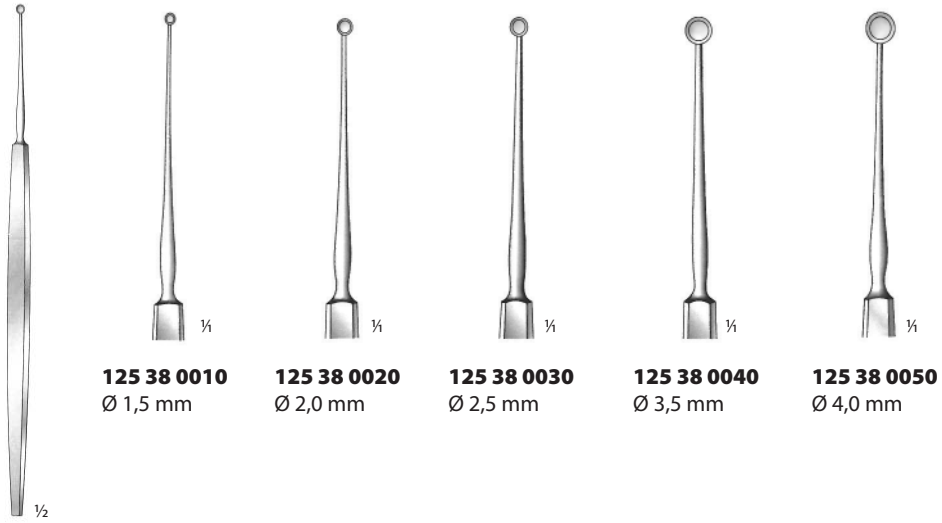

**125 38 0010**  
Ø 1,5 mm

**125 38 0020**  
Ø 2,0 mm

**125 38 0030**  
Ø 2,5 mm

**125 38 0040**  
Ø 3,5 mm

**125 38 0050**  
Ø 4,0 mm

**MEYHÖFER**  
**125 38 0040**  
13,0 cm



**DAVIEL**  
**125 38 0360**  
13,3 cm  
Fig. 1



**DAVIEL**  
**125 38 0370**  
13,3 cm  
Fig. 2

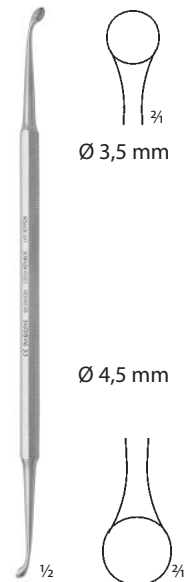

**LANG**  
**125 38 0530**  
15,0 cm



**125 17 0120**  
21,5 cm  
2 × 4 mm

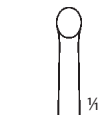

**125 17 0130**  
21,5 cm  
3 × 4 mm



**125 17 0140**  
21,5 cm  
4 × 8 mm



**125 17 0150**  
21,5 cm  
5 × 9 mm



**125 17 0160**  
21,5 cm  
9 × 12 mm



**125 17 0170**  
21,5 cm  
12 × 16 mm

**KUNC**  
**125 17 0170**  
21,5 cm

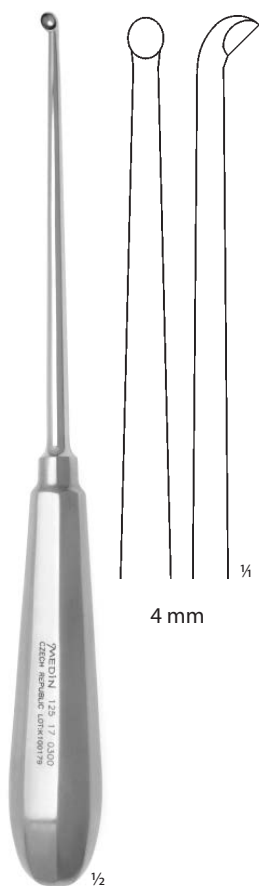

**CLOWARD**  
**125 17 0300**  
23,0 cm

4 mm



**125 09 0010**  
35,0 cm  
14,5 × 23,7 mm



# 127

## PILKY, PILNÍKY SAWS, FILES





PILKY RUČNÍ NA SÁDROVÉ OBVAZY  
PLASTER SAWS

**WIGMORE**  
**127 91 0001**  
19,0 cm



**ENGEL**  
**127 91 0002**  
14,0 cm

 PILKA ELEKTRICKÁ NA SÁDROVÉ OBVAZY  
DRESSING ELECTRICAL SAW

**127 91 0003** = 220 V / 500 W (evropská zástrčka / EU-plug) + **127 91 0005**  
+ **127 91 0006** + **127 91 0007**)

**127 91 0004** = 110 V / 500 W (americká zástrčka / USA-plug) + **127 91 0005**  
+ **127 91 0006** + **127 91 0007**)

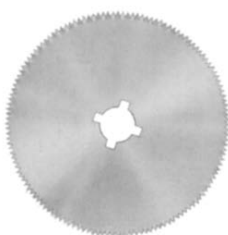

**127 91 0005**  
na tvrdou sádku  
for hard plaster  
Ø 5,0 cm

**127 91 0006**  
na tvrdou sádku  
for hard plaster  
Ø 6,5 cm



**127 91 0007**



**GUTSCH**  
**127 08 0030**  
sada  
set  
39,0 cm



**127 08 0050**  
26,5 cm  
14 zubů na 1"  
14 teeth in 1"



**127 08 0060**  
26,5 cm  
18 zubů na 1"  
18 teeth in 1"



**127 91 0052**  
22,0 cm



**127 91 0053**  
24,5 cm



**127 91 0054**  
28,0 cm



**PUTTI**  
**127 91 0055**  
27,0 cm



**PUTTI**  
**127 91 0056**  
30,0 cm



# 128

**DLÁTA, KLADIVA**  
**CHISELS, MALLETS**









**128 01 0030**  
14,5 cm



**LEBSCHE**  
**128 91 0214**  
25,0 cm



**128 08 0901**  
22,0 cm  
250 g



**128 08 0911**  
23,5 cm  
500 g



**128 08 0921**  
23,5 cm  
700 g

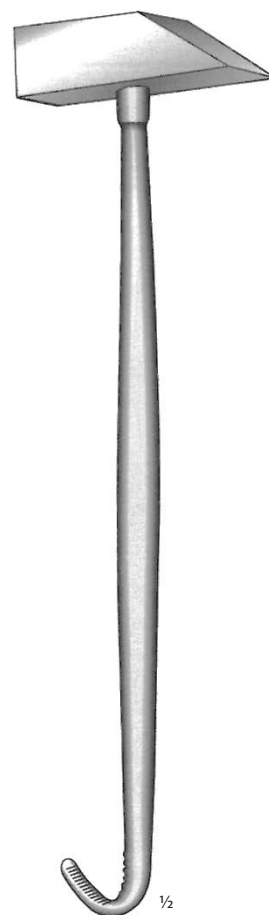

**128 01 0050**  
23,5 cm

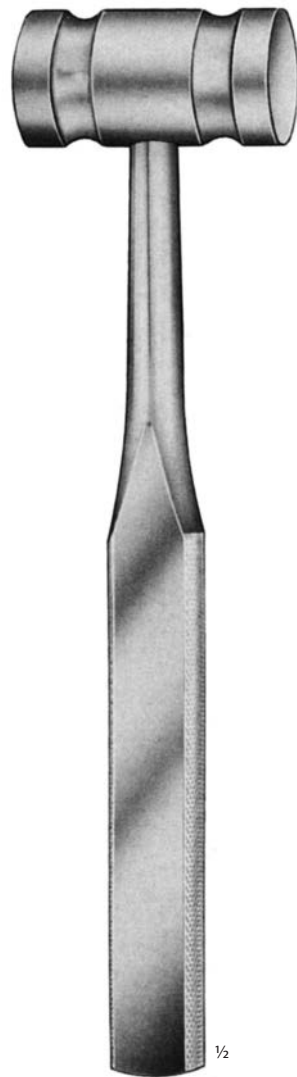

**128 91 0237**  
26,5 cm  
450 g

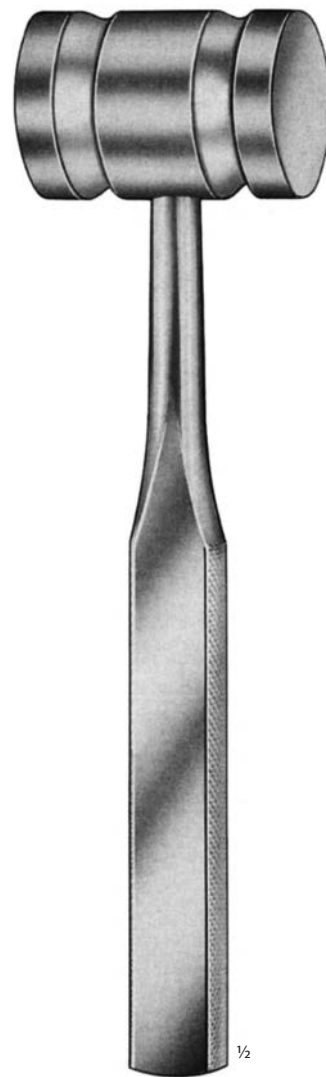

**128 91 0238**  
26,5 cm  
900 g

DLÁTA  
CHISELS

## STILLE

<b>128 08 1050</b>	6,0 mm	20,5 cm
<b>128 08 1060</b>	8,0 mm	20,5 cm
<b>128 08 0010</b>	10,0 mm	20,5 cm
<b>128 08 0020</b>	12,0 mm	20,5 cm
<b>128 08 0030</b>	15,0 mm	20,5 cm
<b>128 08 0040</b>	20,0 mm	20,5 cm
<b>128 08 0050</b>	25,0 mm	20,5 cm



## STILLE

<b>128 08 0160</b>	15,0 mm	20,5 cm
--------------------	---------	---------

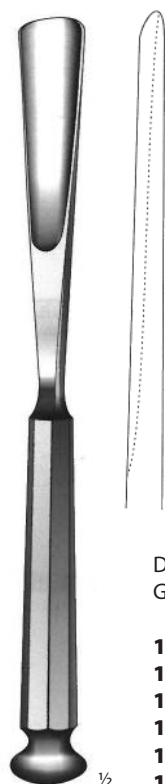
DLÁTA ŽLÁBKOVÁ  
GOUGES

Dláto žlábkové obloukové  
Gouge bow-shaped

<b>128 08 0250</b>	10,0 mm	20,5 cm
<b>128 08 0260</b>	15,0 mm	20,5 cm
<b>128 08 0270</b>	20,0 mm	20,5 cm
<b>128 08 0280</b>	25,0 mm	20,5 cm
<b>128 08 0290</b>	30,0 mm	20,5 cm
<b>128 08 0390</b>	35,0 mm	20,5 cm

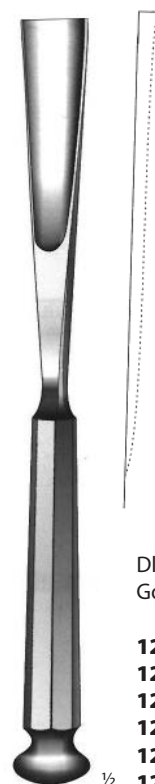

Dláto žlábkové rovné  
Gouge; straight

<b>128 08 0300</b>	10,0 mm	20,5 cm
<b>128 08 0310</b>	15,0 mm	20,5 cm
<b>128 08 0320</b>	20,0 mm	20,5 cm
<b>128 08 0330</b>	25,0 mm	20,5 cm
<b>128 08 0340</b>	30,0 mm	20,5 cm
<b>128 08 0350</b>	35,0 mm	20,5 cm

# 132

## JEHLY, JEHELCE NEEDLES, NEEDLE HOLDERS





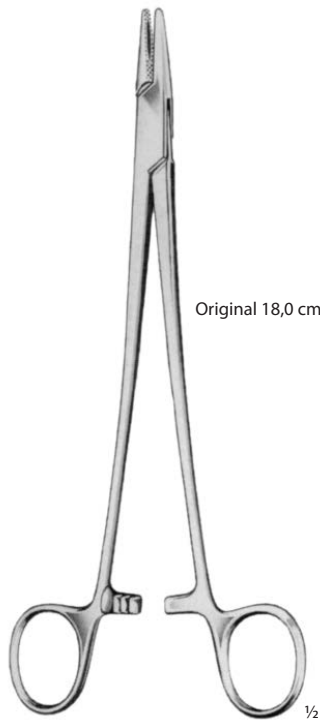

Original 18,0 cm

**MAYO-HEGAR**



**132 91 0030**  
14,0 cm



**132 91 0031**  
16,0 cm



**132 91 0032**  
18,0 cm



**132 91 0033**  
20,0 cm



**132 91 0034**  
24,0 cm



**132 91 0035**  
26,0 cm



**132 91 0036**  
30,0 cm



**132 91 0037**  
16,0 cm

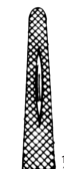

**132 91 0038**  
18,0 cm



**132 91 0039**  
20,0 cm

**MAYO-HEGAR-DELICATE**



**HEANEY**  
**132 91 0040**  
21,0 cm

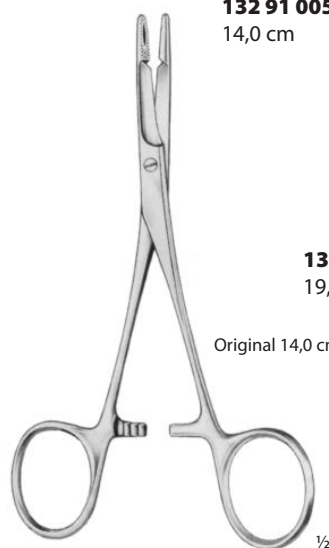

**OLSEN-HEGAR**

Original 14,0 cm



**132 91 0050**  
14,0 cm



**132 91 0051**  
17,0 cm



**132 91 0052**  
19,0 cm



**132 06 0341**  
16,5 cm

JEHELCE  
NEEDLE HOLDERS



**MATHIEU**  
**132 06 0200** 14,0 cm  
**132 06 0220** 17,0 cm

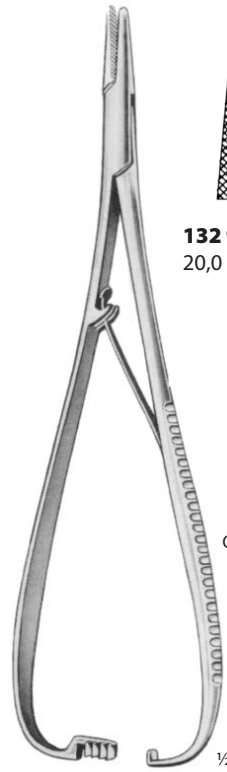

**MATHIEU**

**132 91 0056**  
20,0 cm

**132 91 0057**  
24,0 cm



¼

¼

Original 20,0 cm



**CRILE**

**132 06 0300**  
15,0 cm



¼

Original 15,0 cm

½



**132 06 0810**  
20,0 cm



¼

½

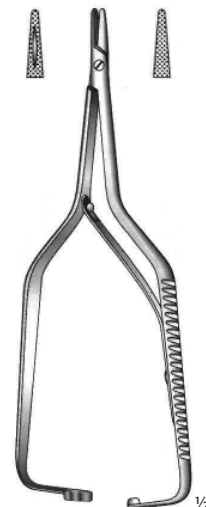

**BOYNTON**  
**132 38 0120**  
12,5 cm



½





**132 06 0590**  
13,0 cm



**132 06 0580**  
13,0 cm



**132 06 0610**  
16,0 cm



**132 06 0620**  
20,0 cm

**132 06 0630**  
26,0 cm

**JEHELCE TVRDOKOVÉ**  
NEEDLE HOLDERS WITH TUNGSTEN CARBIDE INSERT



Original 18,0 cm

**MAYO-HEGAR**



**132 91 0096**  
14,0 cm



**132 91 0097**  
16,0 cm



**132 91 0098**  
18,0 cm



**132 91 0099**  
20,0 cm



**132 91 0100**  
24,0 cm



**132 91 0101**  
26,0 cm



**132 91 0102**  
30,0 cm



Original 20,0 cm

**DE BAKEY**  
**(MAYO-HEGAR-DELICATE)**



**132 91 0103**  
18,0 cm



**132 91 0104**  
20,0 cm



**132 91 0105**  
23,0 cm



**132 91 0106**  
26,0 cm



**132 91 0107**  
31,0 cm

**JEHELCE TVRDOKOVOVÉ**  
NEEDLE HOLDERS WITH TUNGSTEN CARBIDE INSERT



- |                               |                               |                               |                               |
|-------------------------------|-------------------------------|-------------------------------|-------------------------------|
|                               |                               |                               |                               |
| <b>132 91 0108</b><br>13,0 cm | <b>132 06 0600</b><br>16,5 cm | <b>132 06 0640</b><br>20,5 cm | <b>132 06 0650</b><br>25,5 cm |

Original 20,5 cm

**RYDER/FRENCH-EYE**

- |                               |                               |                               |                               |
|-------------------------------|-------------------------------|-------------------------------|-------------------------------|
|                               |                               |                               |                               |
| <b>132 91 0120</b><br>14,0 cm | <b>132 91 0121</b><br>18,0 cm | <b>132 91 0122</b><br>20,0 cm | <b>132 91 0123</b><br>23,0 cm |

**EUFRATE PASQUÉ**  
velmi jemné  
extra delicate



- |                               |                               |                               |                               |
|-------------------------------|-------------------------------|-------------------------------|-------------------------------|
|                               |                               |                               |                               |
| <b>132 91 0124</b><br>14,0 cm | <b>132 91 0125</b><br>18,0 cm | <b>132 91 0126</b><br>20,0 cm | <b>132 91 0127</b><br>23,0 cm |

**MICROVASCULAR**  
velmi jemné  
extra delicate

Original 20,0 cm

JEHELCE TVRDOKOVOVÉ  
NEEDLE HOLDERS WITH TUNGSTEN CARBIDE INSERT

**NEW ORLEANS**  
**132 91 0130**  
18,0 cm



**SENNING (SWED. MOD.)**



**DERF**  
**132 91 0133**  
12,5 cm

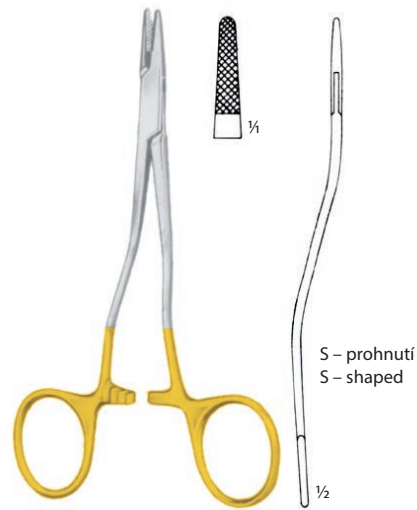

**KILNER**  
**132 91 0135**  
13,5 cm



**WEBSTER**  
132 91 0137  
13,0 cm



**BABY-CRILE-WOOD**  
132 91 0140  
15,0 cm



**CRILE-WOOD**  
132 91 0142  
15,0 cm



132 91 0138



132 91 0139

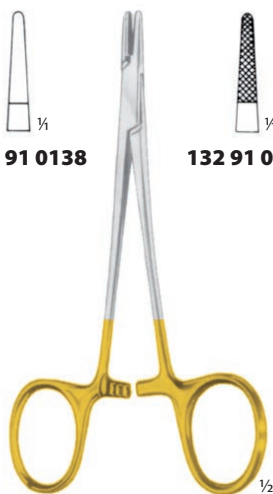

**HALSEY**  
13,0 cm



**CRILE-WOOD**



132 91 0143  
18,0 cm



132 91 0144  
20,0 cm



132 91 0145  
23,0 cm

Original 20,0 cm

JEHELCE TVRDOKOVOVÉ  
NEEDLE HOLDERS WITH TUNGSTEN CARBIDE INSERT



**132 91 0148**  
27,0 cm

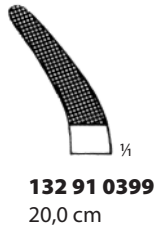

**132 91 0399**  
20,0 cm

**FINOCHIETTO**

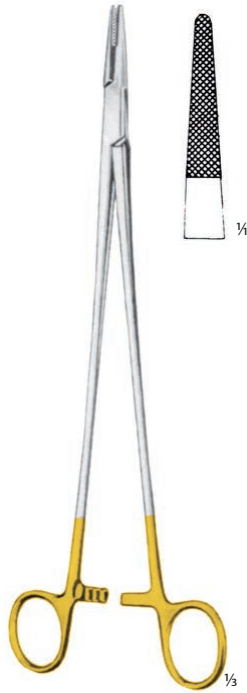

**WANGENSTEEN**  
**132 91 0149**  
27,0 cm

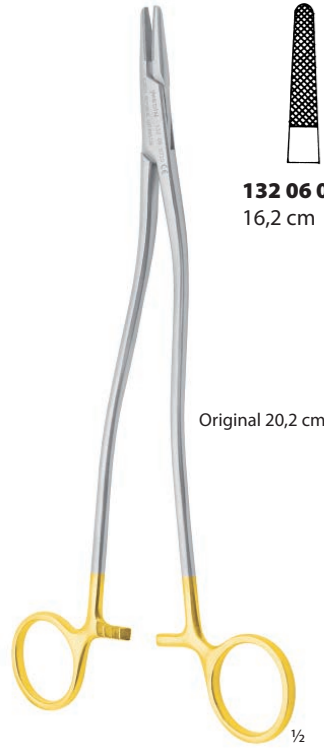

**132 06 0710**  
16,2 cm

**132 06 0720**  
20,2 cm

Original 20,2 cm

**132 06 0730**  
25,0 cm

**BOZEMANN**



S – prohnutí  
S – shaped



**132 91 0154**  
18,0 cm

**132 91 0155**  
26,0 cm

Original 18,0 cm

**SAROT**



**MASSON**  
**132 91 0156**  
27,0 cm

JEHELCE TVRDOKOVOVÉ  
NEEDLE HOLDERS WITH TUNGSTEN CARBIDE INSERT



OLSEN-HEGAR

**132 91 0160**  
14,0 cm

**132 91 0161**  
17,0 cm

**132 91 0162**  
19,0 cm

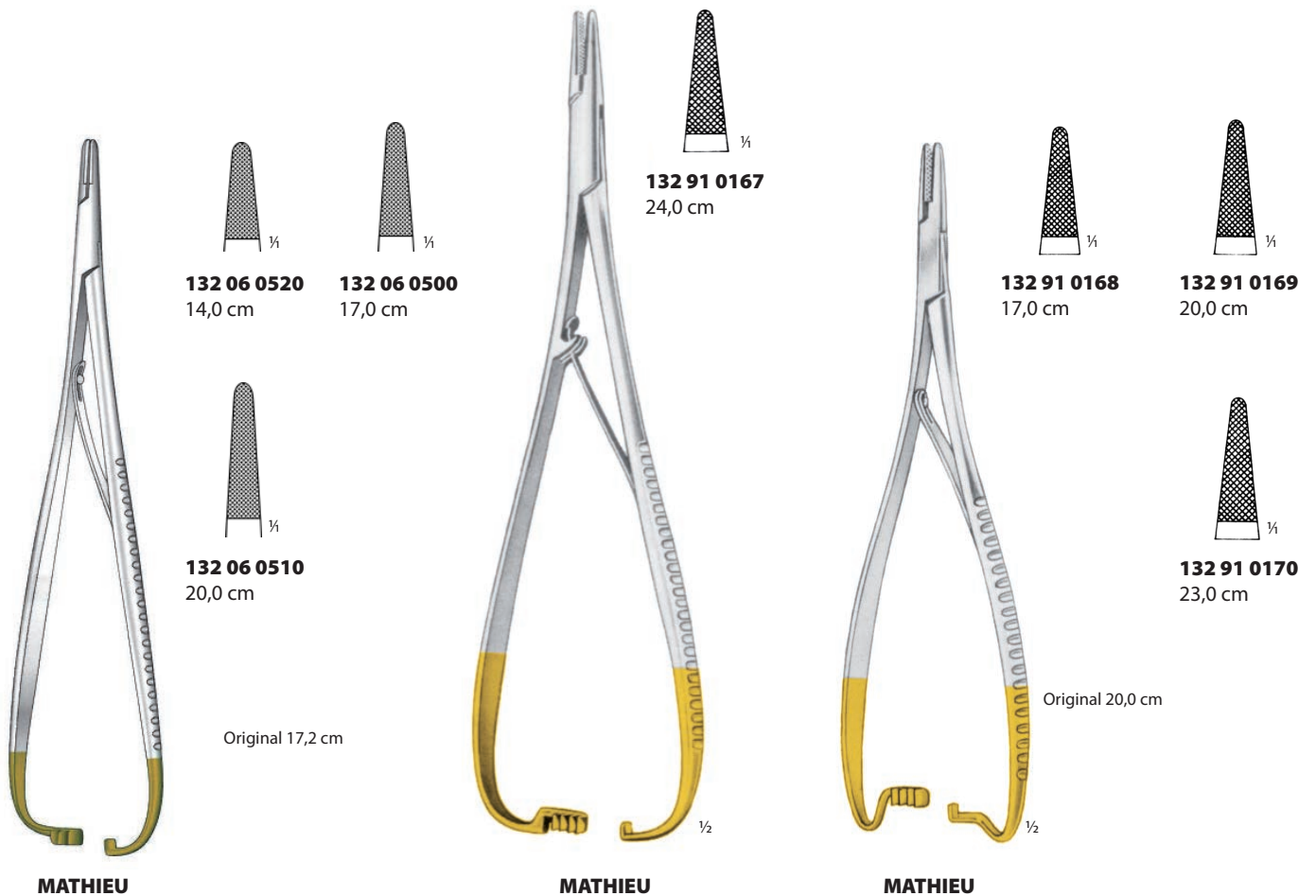

MATHIEU

MATHIEU

MATHIEU

**132 06 0520**  
14,0 cm

**132 06 0500**  
17,0 cm

**132 06 0510**  
20,0 cm

Original 17,2 cm

**132 91 0167**  
24,0 cm

**132 91 0168**  
17,0 cm

**132 91 0169**  
20,0 cm

**132 91 0170**  
23,0 cm

Original 20,0 cm

JEHELCE TVRDOKOVÉ  
NEEDLE HOLDERS WITH TUNGSTEN CARBIDE INSERT



**132 06 0370**  
15,7 cm  
diamant  
diamont

**CRILE**



**132 06 0450**  
16,2 cm

**CRILE**

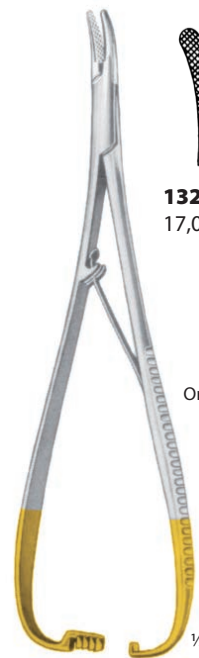

**132 91 0174** **132 91 0175**  
17,0 cm 19,5 cm

Original 17,0 cm

**METZENBAUM**



**132 91 0176** **132 91 0177**  
17,0 cm 20,0 cm

Original 20,0 cm

**MATHIEU-RYDER**



**132 06 0830**  
20,0 cm



JEHELCE TVRDOKOVOVÉ  
NEEDLE HOLDERS WITH TUNGSTEN CARBIDE INSERT



**BOYNTON**  
**132 91 0182**  
12,0 cm



**LUETHY-BECK**  
**132 91 0192**  
20,0 cm



**HÖSEL**  
**132 91 0186**  
25,0 cm



**LANGENBECK**



**LANGENBECK**

**132 91 0194**  
18,0 cm

**132 91 0195**  
20,0 cm



**LANGENBECK-DELICATE**

**132 91 0196**  
18,0 cm

**132 91 0197**  
20,0 cm



**LANGENBECK-RYDER**

**132 91 0199**  
18,0 cm

**132 91 0200**  
20,0 cm

**JEHELCE TVRDOKOVOVÉ**  
NEEDLE HOLDERS WITH TUNGSTEN CARBIDE INSERT

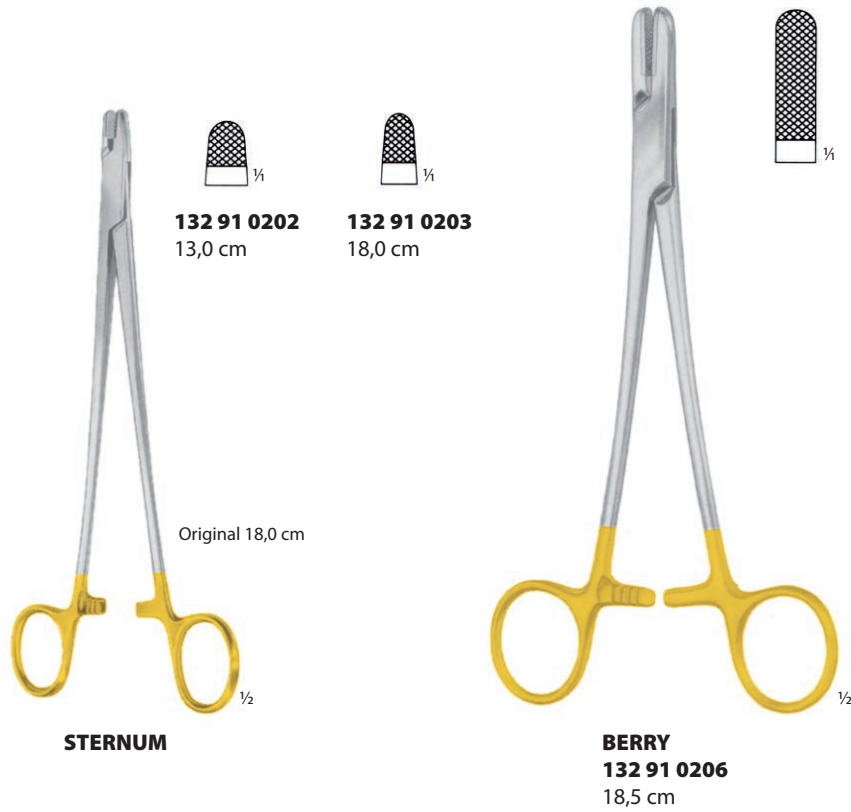

**MIKRO JEHELCE TVRDOKOVOVÉ**  
MICRO-NEEDLE HOLDERS WITH TUNGSTEN CARBIDE INSERT

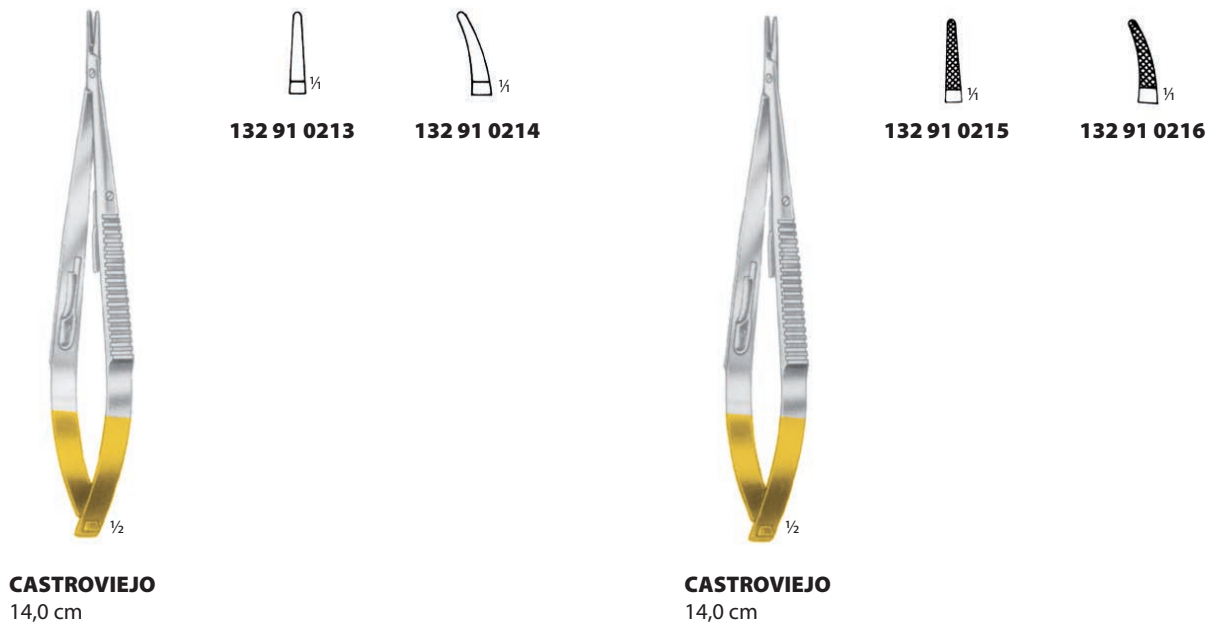

**MIKRO JEHELCE TVRDOKOVOVÉ**  
MICRO-NEEDLE HOLDERS WITH TUNGSTEN CARBIDE INSERT



**132 91 0217**

**132 91 0218**

**CASTROVIEJO**  
18,0 cm



**132 91 0219**

**132 91 0220**

**CASTROVIEJO**  
18,0 cm



**132 91 0221**

**132 91 0222**

**JACOBSON**  
21,0 cm



**132 91 0223**  
16,0 cm

**132 91 0224**  
18,0 cm

**132 91 0225**  
20,0 cm

**132 91 0226**  
23,0 cm

Original 23,0 cm

**132 91 0227**  
26,0 cm

**DIETRICH**



**CASTROVIEJO**  
**132 91 0229**  
13,0 cm

**POTTS-SMITH**  
**132 91 0230**  
22,0 cm

MIKRO JEHELCE  
MICRO-NEEDLE HOLDERS

**BARRAQUER**  
**132 91 0249**  
rovný s uzávěrem  
straight with ratchet  
18,0 cm



**BARRAQUER**  
**132 91 0250**  
zahnutý s uzávěrem  
curved with ratchet  
18,0 cm



**BARRAQUER**  
**132 91 0251**  
rovný  
straight  
18,0 cm



**BARRAQUER**  
**132 91 0252**  
zahnutý  
curved  
18,0 cm

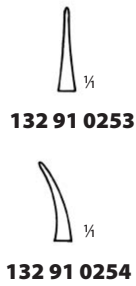
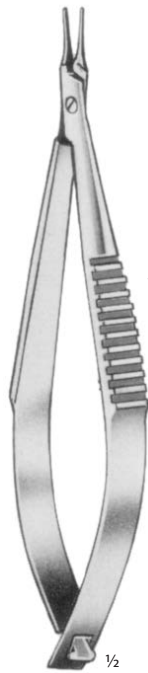

**CASTROVIEJO**  
9,0 cm

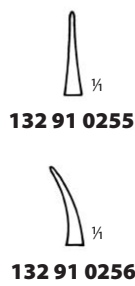
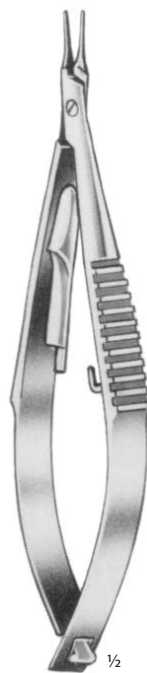

**CASTROVIEJO**  
s uzávěrem  
with ratchet  
9,0 cm

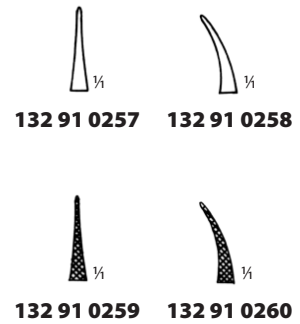

**CASTROVIEJO**  
14,0 cm

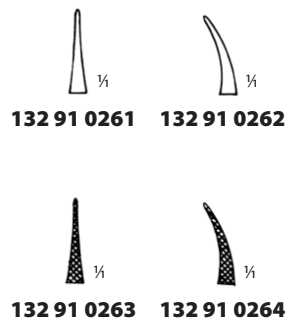

**CASTROVIEJO**  
s uzávěrem  
with ratchet  
14,0 cm

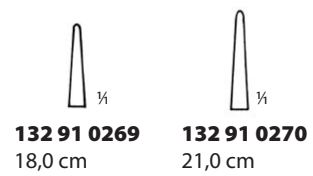
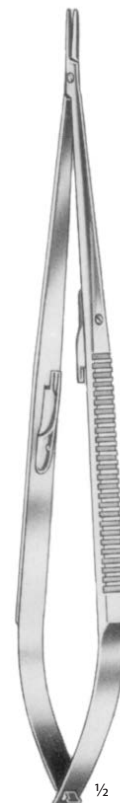

**JACOBSON**  
s uzávěrem  
with ratchet

Original 21,0 cm

MIKRO JEHELCE  
MICRO-NEEDLE HOLDERS

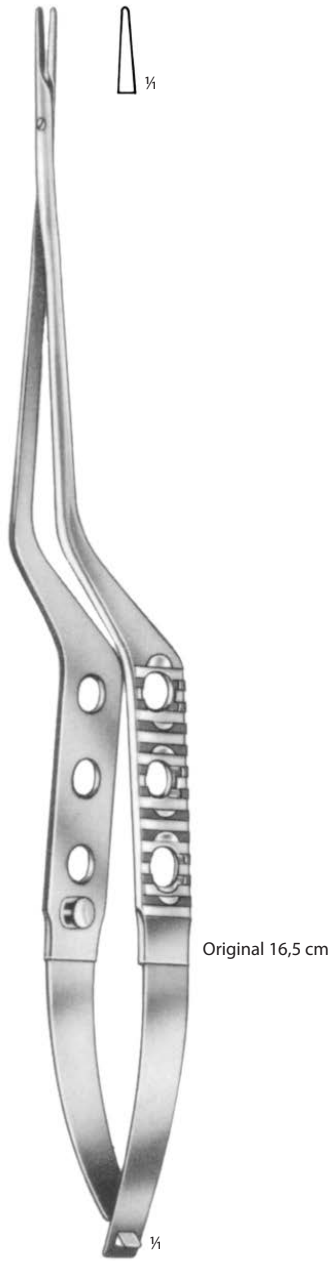

- 132 91 0271** 16,5 cm
- 132 91 0272** 18,0 cm
- 132 91 0273** 20,0 cm
- 132 91 0274** 22,0 cm



- 132 91 0275** 16,5 cm
- 132 91 0276** 18,0 cm
- 132 91 0277** 20,0 cm
- 132 91 0278** 22,0 cm

**JEHELCE PRO PLASTIKU**  
NEEDLE HOLDERS FOR PLASTIC

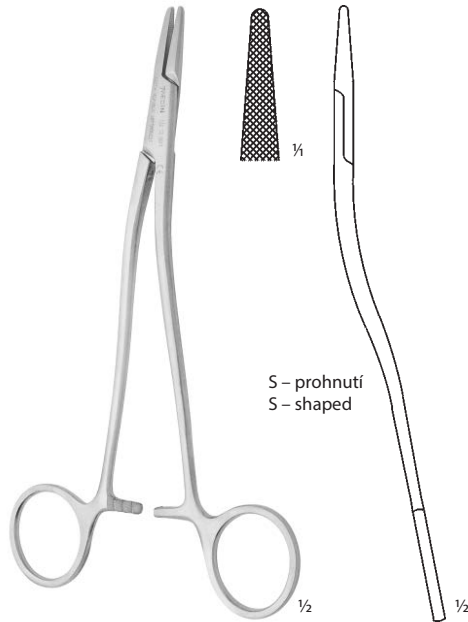

**132 12 0011**  
16,2 cm

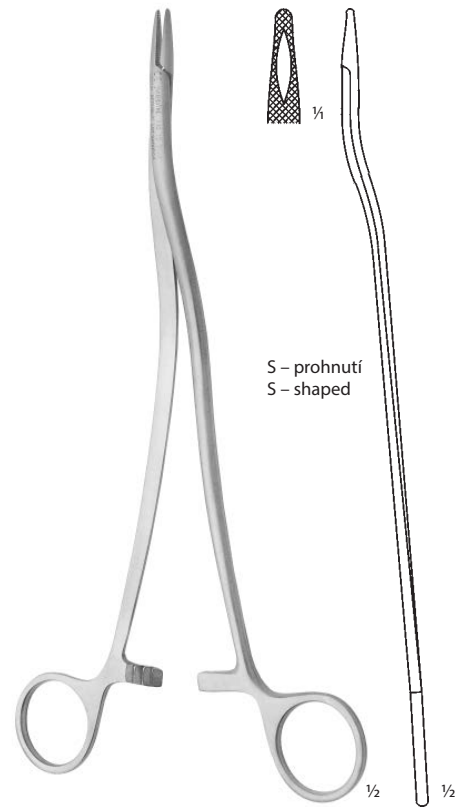

**132 12 0020**  
21,0 cm

**JEHELCE NEUROCHIRURGICKÉ**  
NEUROSURGICAL NEEDLE HOLDERS



**132 17 0021**  
13,0 cm



**132 91 0439** 15,0 cm  
**132 91 0440** 18,0 cm  
**132 91 0441** 23,0 cm

**JEHELCE NEUROCHIRURGICKÉ MIKRO**  
**NEUROSURGICAL MICRO-NEEDLE HOLDERS**
**BARRAQUER**
 špička – tip  
 0,3 mm

**132 91 0415**  
 14,0 cm

**132 91 0416**  
 18,0 cm

 špička – tip  
 0,8 mm

**132 91 0419**  
 14,0 cm

**132 91 0420**  
 18,0 cm

 špička – tip  
 0,3 mm

**132 91 0417**  
 14,0 cm

**132 91 0418**  
 18,0 cm

 špička – tip  
 0,8 mm

**132 91 0421**  
 14,0 cm

**132 91 0422**  
 18,0 cm
**BARRAQUER**
 špička – tip  
 0,3 mm

**132 91 0423**  
 14,0 cm

**132 91 0424**  
 18,0 cm

 špička – tip  
 0,8 mm

**132 91 0427**  
 14,0 cm

**132 91 0428**  
 18,0 cm

 špička – tip  
 0,3 mm

**132 91 0425**  
 14,0 cm

**132 91 0426**  
 18,0 cm

 špička – tip  
 0,8 mm

**132 91 0429**  
 14,0 cm

**132 91 0430**  
 18,0 cm





**REVERDIN**  
14,0 cm



**132 91 0297**  
Fig.1



**132 91 0298**  
Fig.2



**132 91 0299**  
Fig.3



**132 91 0300**  
Fig.4



**REVERDIN**  
19,5 cm  
22,5 cm

Original 19,5 cm



**132 91 0301**  
**132 91 0305**  
Fig.1



**132 91 0302**  
**132 91 0306**  
Fig.2



**132 91 0303**  
**132 91 0307**  
Fig.3



**132 91 0304**  
**132 91 0308**  
Fig.4

JEHLY PODVAZOVACÍ  
LIGATURE NEEDLES

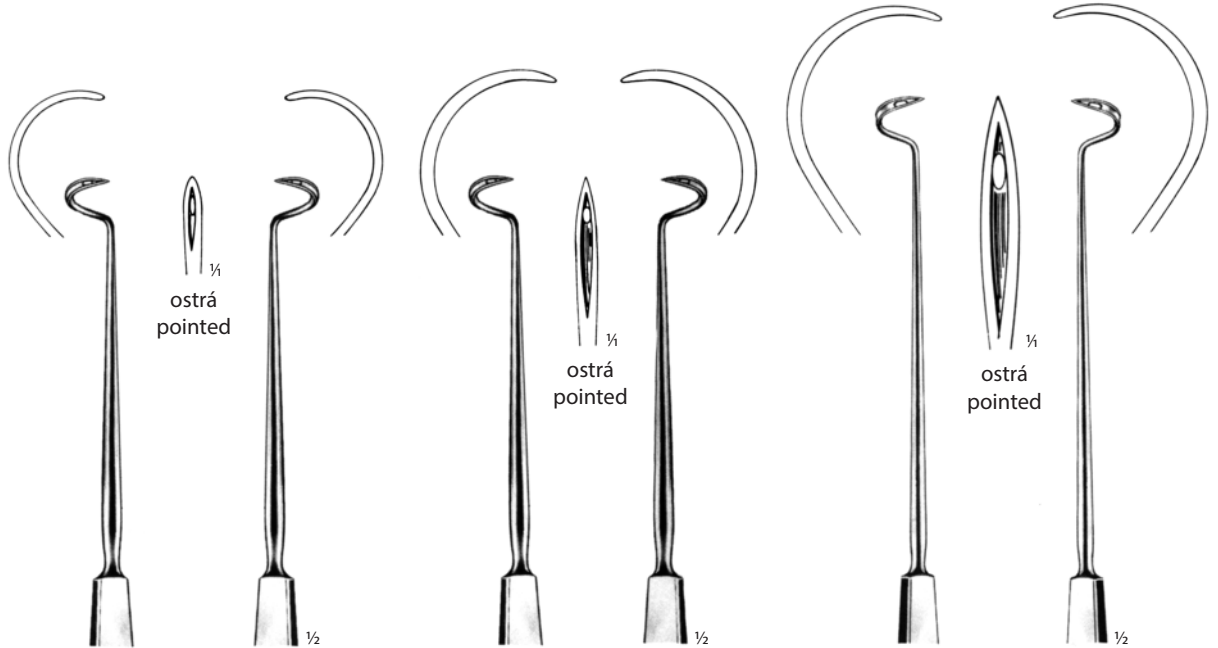

**132 91 0309**  
20,0 cm

**132 91 0310**  
20,0 cm

**132 91 0312**  
20,0 cm

**132 91 0311**  
20,0 cm

**132 91 0313**  
21,0 cm

**132 91 0315**  
21,0 cm

**132 91 0314**  
27,0 cm

**132 91 0316**  
27,0 cm



**DESCHAMPS**

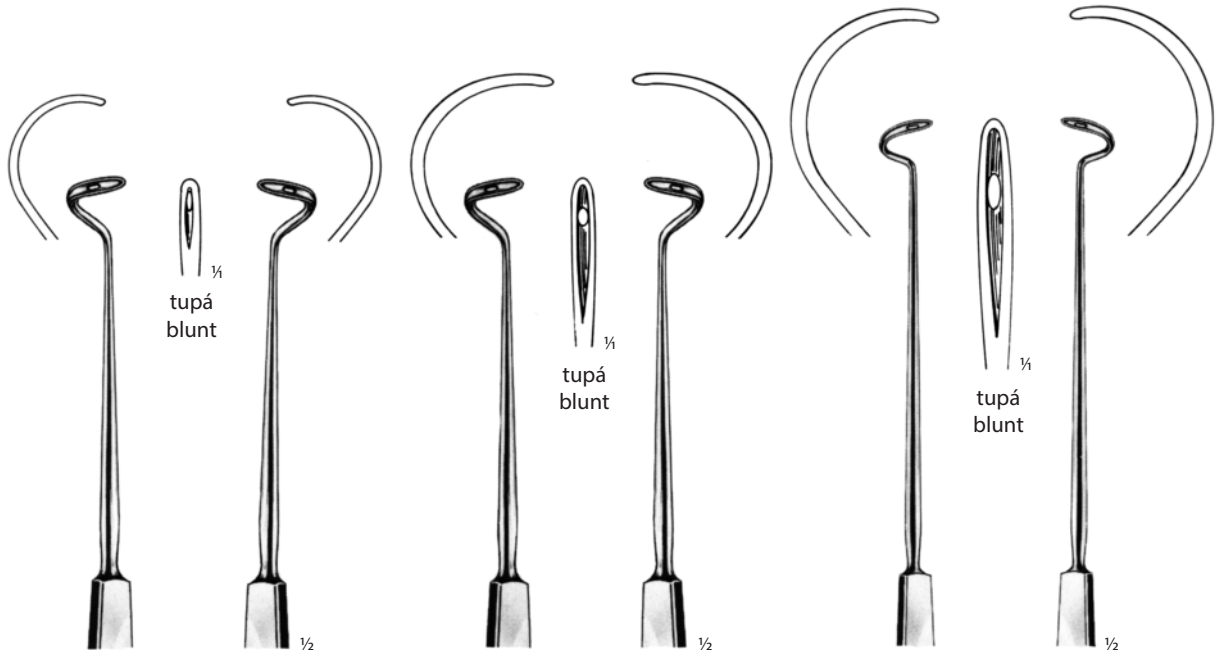

**132 91 0317**  
20,0 cm

**132 91 0318**  
20,0 cm

**132 91 0320**  
20,0 cm

**132 91 0319**  
20,0 cm

**132 91 0321**  
21,0 cm

**132 91 0323**  
21,0 cm

**132 91 0322**  
27,0 cm

**132 91 0324**  
27,0 cm

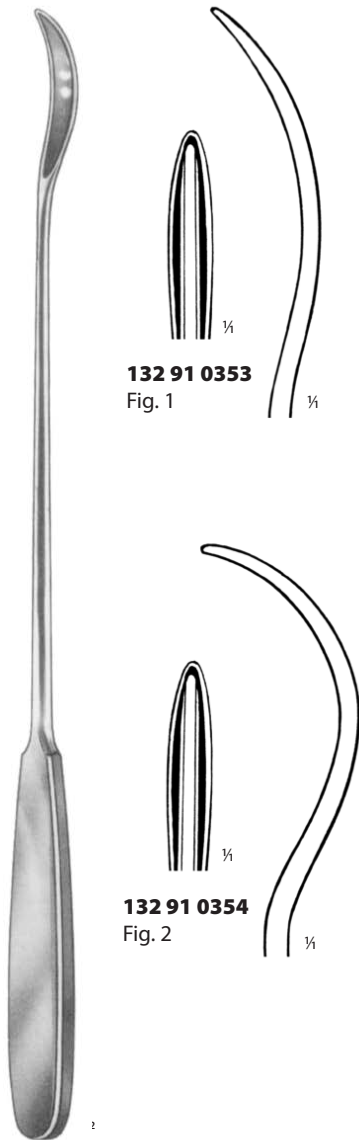

**132 91 0353**  
Fig. 1

**132 91 0354**  
Fig. 2

**BRUNNER**  
30,0 cm

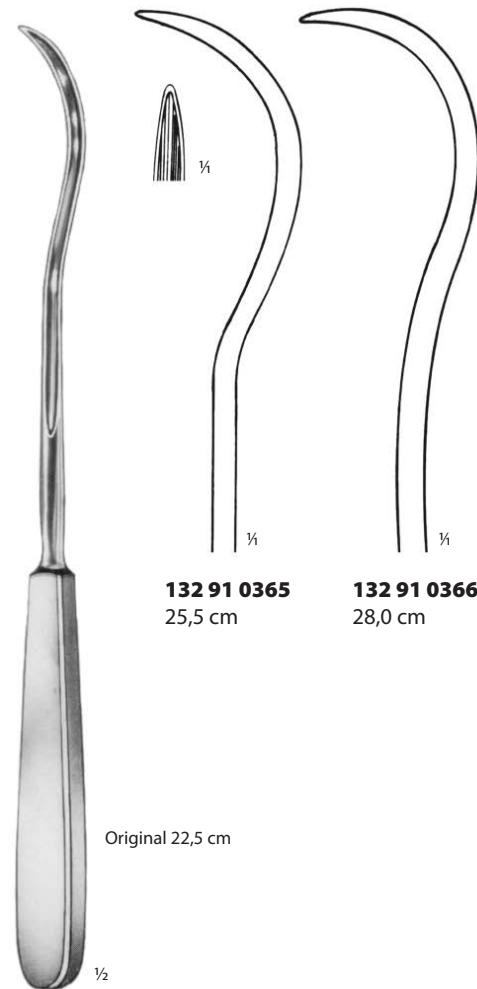

**132 91 0365**  
25,5 cm

**132 91 0366**  
28,0 cm

Original 22,5 cm

**KIRSCHNER**

JEHLY PODVAZOVACÍ  
LIGATURE NEEDLES



**PAYR**  
**132 91 0358**  
22,0 cm



**PAYR**  
**132 91 0359**  
22,0 cm

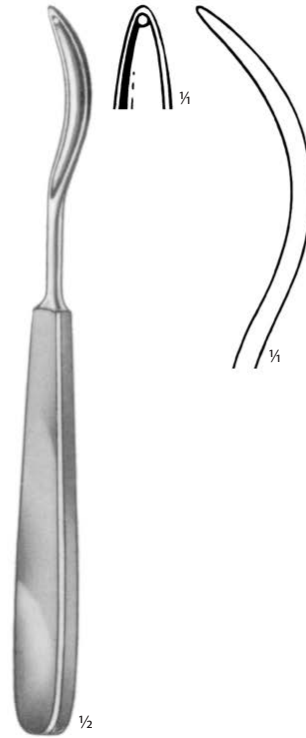

**SCHMIEDEN-PAYR**  
**132 91 0360**  
19,0 cm

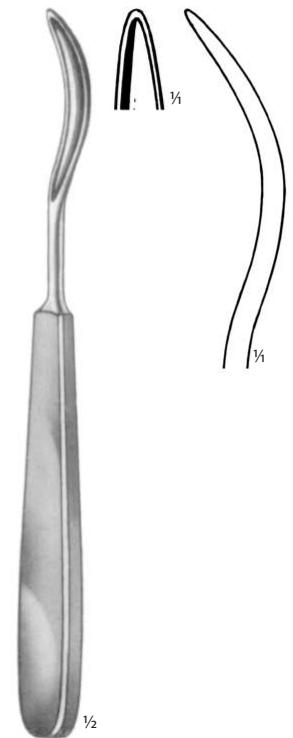

**SCHMIEDEN-PAYR**  
**132 91 0361**  
19,0 cm

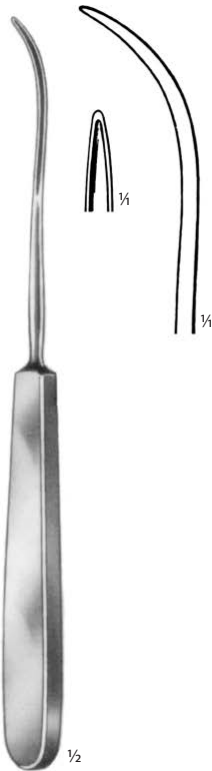

**KÖNIG**  
**132 91 0362**  
19,5 cm



**KÖNIG**  
**132 91 0363**  
19,5 cm

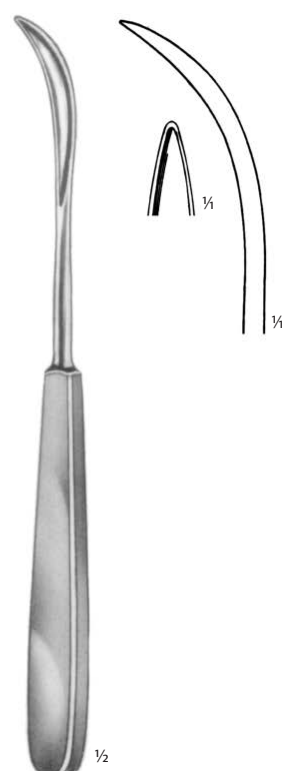

**KÖNIG**  
**132 91 0364**  
19,5 cm



**MICHEL**  
**132 91 0382**  
12,0 cm



**COLLIN**  
**132 91 0383**  
13,0 cm



**HEGENBARTH**  
**132 91 0386**  
12,5 cm

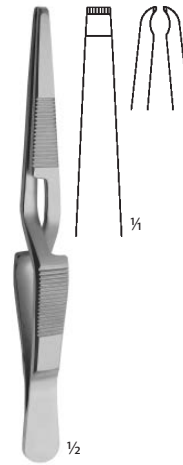

**HEGENBARTH**  
**114 06 0010**  
12,0 cm



**MICHEL**  
**132 91 0387**  
12,0 cm



**MICHEL**

Balení: 1000 ks  
Unit for sale: 1000 pcs

Objednávací číslo Order number	Velikosti Sizes
<b>AE870/08</b>	7,5 × 1,75 mm
<b>AE870/11</b>	11,0 × 2,5 mm
<b>AE870/12</b>	12,0 × 3,0 mm
<b>AE870/14</b>	14,0 × 3,0 mm
<b>AE870/16</b>	16,0 × 3,0 mm
<b>AE870/18</b>	18,0 × 3,0 mm
<b>AE870/20</b>	20,0 × 3,0 mm
<b>AE870/22</b>	22,0 × 3,0 mm



JEHLA ŠÍCÍ PITEVNÍ  
POST MORTEM SUTURING NEEDLE**132 01 0050**zahnutá  
curved  
11,0 cm

# 133

## PÁTRADLA PROBES

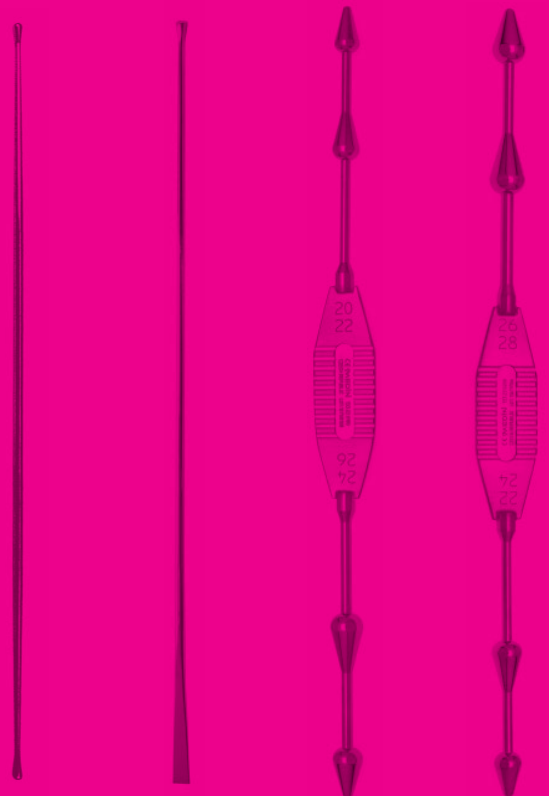







Pátradlo paličkové  
Probe olive  
**133 08 0020** 14,0 cm  
**133 08 0050** 20,0 cm  
**133 08 0060** 25,0 cm

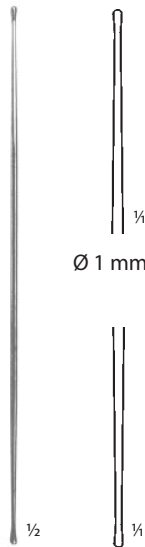

Pátradlo paličkové  
Probe olive  
**133 08 0140**  
14,0 cm



Pátradlo paličkové s dlátkem  
Probe olive with chisel  
**133 08 0100** 14,0 cm  
**133 08 0110** 20,0 cm



Pátradlo žlábkové  
Probe  
**133 08 0090**  
14,0 cm



**DESJARDINES**  
**133 20 0010**  
27,0 cm



**DESJARDINES**  
**133 20 0020**  
27,0 cm

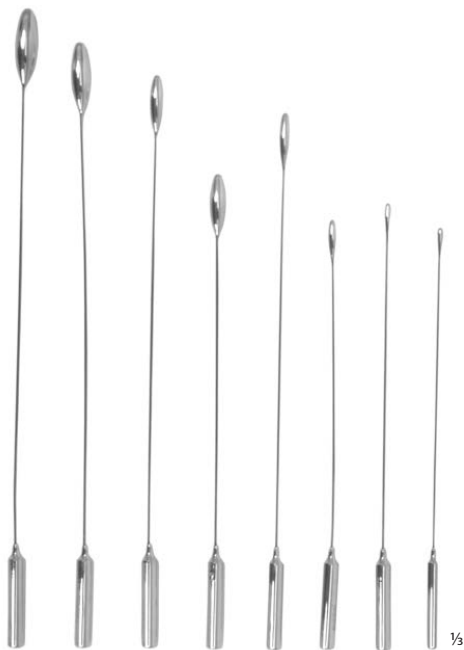

**BAKEŠ**  
**133 20 0050**  
soubor  
set

<b>133 20 0070</b>	17,0 cm	Ø 2,5 mm
<b>133 20 0080</b>	18,0 cm	Ø 3,0 mm
<b>133 20 0090</b>	17,3 cm	Ø 4,0 mm
<b>133 20 0100</b>	21,5 cm	Ø 5,0 mm
<b>133 20 0110</b>	22,8 cm	Ø 6,0 mm
<b>133 20 0120</b>	19,0 cm	Ø 7,0 mm
<b>133 20 0130</b>	24,0 cm	Ø 8,0 mm
<b>133 20 0140</b>	25,2 cm	Ø 9,0 mm

**SOUBOR SOND NA KŘEČOVÉ ŽÍLY**  
VARICOSE VEIN PROBES SET

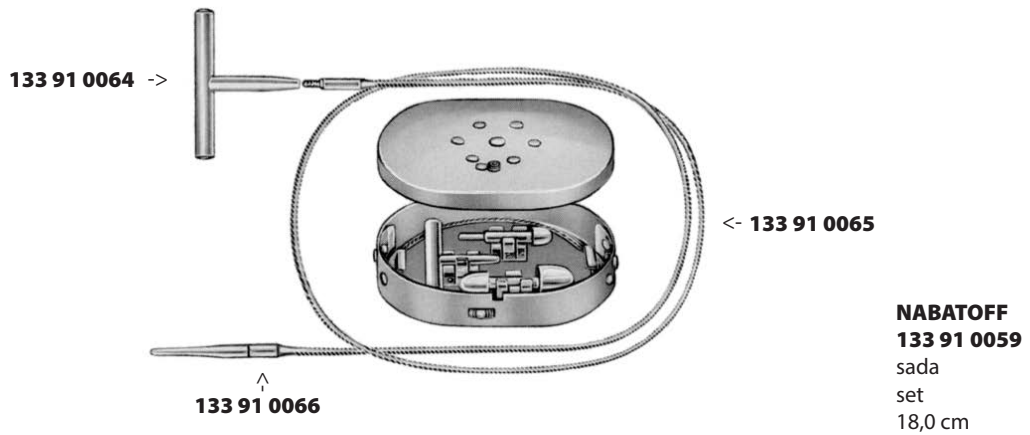
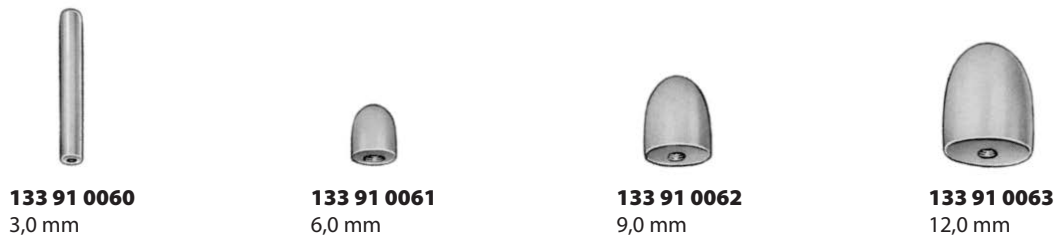

**CÉVNÍ SONDY**  
VASCULAR PROBES

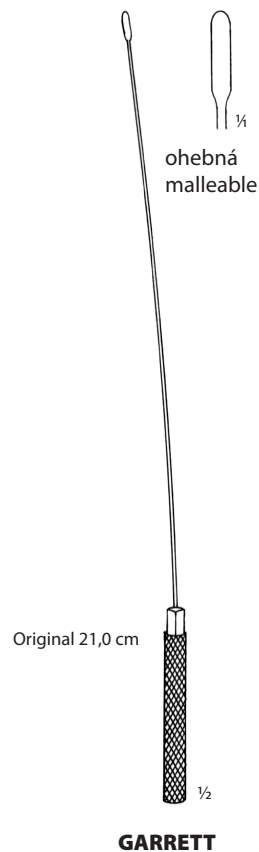

14,0 cm	21,0 cm	Ø
<b>133 91 0067</b>	<b>133 91 0076</b>	1,0 mm
<b>133 91 0068</b>	<b>133 91 0077</b>	1,5 mm
<b>133 91 0069</b>	<b>133 91 0078</b>	2,0 mm
<b>133 91 0070</b>	<b>133 91 0079</b>	2,5 mm
<b>133 91 0071</b>	<b>133 91 0080</b>	3,0 mm
<b>133 91 0072</b>	<b>133 91 0081</b>	3,5 mm
<b>133 91 0073</b>	<b>133 91 0082</b>	4,0 mm
<b>133 91 0074</b>	<b>133 91 0083</b>	4,5 mm
<b>133 91 0075</b>	<b>133 91 0084</b>	5,0 mm

**133 22 0170**

19,6 cm  
12 Ch  
14 Ch  
16 Ch  
18 Ch  
16 Ch

**133 22 0190**

19,6 cm  
14 Ch  
16 Ch  
20 Ch  
18 Ch

**133 22 0180**

20,6 cm  
20 Ch  
22 Ch  
26 Ch  
24 Ch

**133 22 0200**

20,6 cm  
22 Ch  
24 Ch  
28 Ch  
26 Ch



**BOWMANN**  
Pátradlo oční  
Eye probe  
**133 38 0060**  
13,0 cm

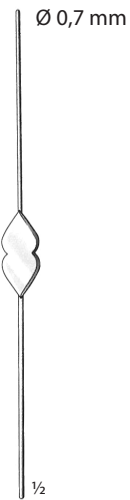

**BOWMANN**  
Pátradlo oční  
Eye probe  
**133 38 0070**  
13,0 cm

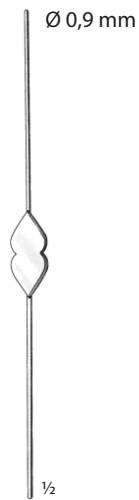

**BOWMANN**  
Pátradlo oční  
Eye probe  
**133 38 0080**  
13,0 cm



**133 38 0110**  
Dilatátor oční  
Eye dilator  
7,5 cm  
Ø 0,1 mm



**133 38 0120**  
Dilatátor oční  
Eye dilator  
7,5 cm  
Ø 0,25 mm



**133 38 0130**  
Dilatátor oční  
Eye dilator  
7,5 cm  
Ø 0,4 mm



## TROKARY, ODSÁVAČKY TROCARS, SUCTION TUBES

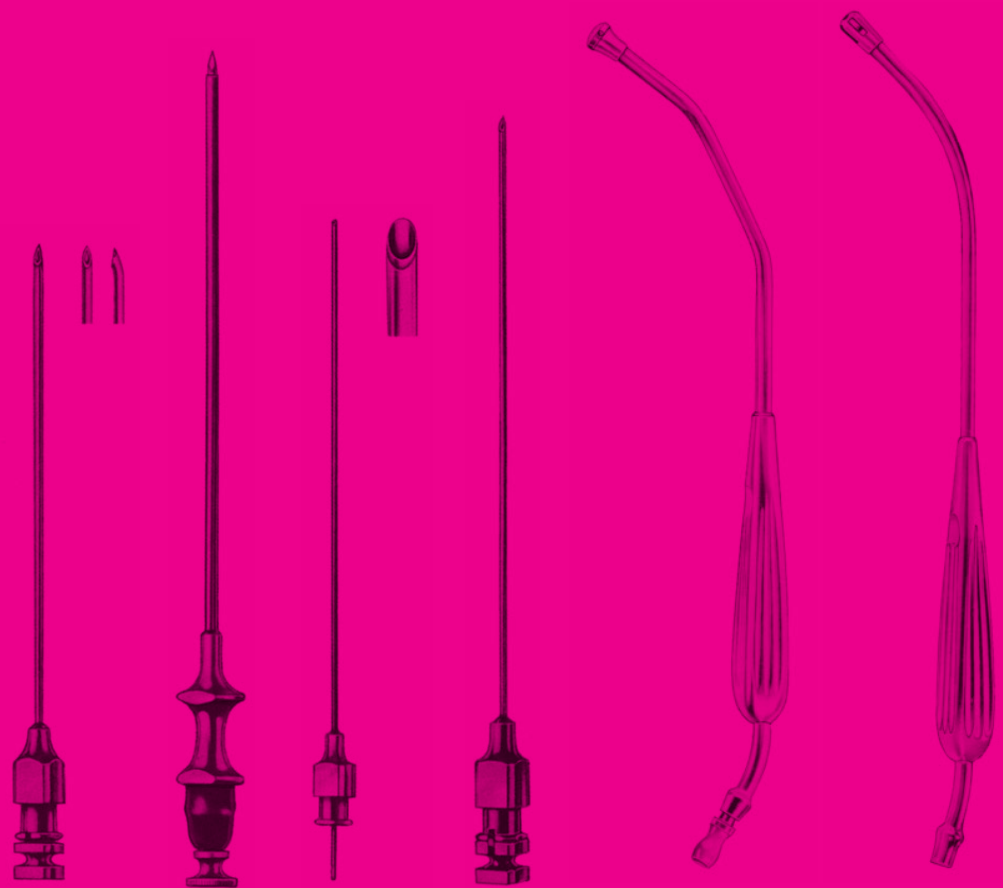







		Ø
<b>134 91 0141</b>	8 Charr.	2 2/3 mm
<b>134 91 0142</b>	10 Charr.	3 1/3 mm
<b>134 91 0143</b>	12 Charr.	4 mm
<b>134 91 0144</b>	14 Charr.	4 2/3 mm
<b>134 91 0145</b>	16 Charr.	5 1/3 mm
<b>134 91 0146</b>	18 Charr.	6 mm

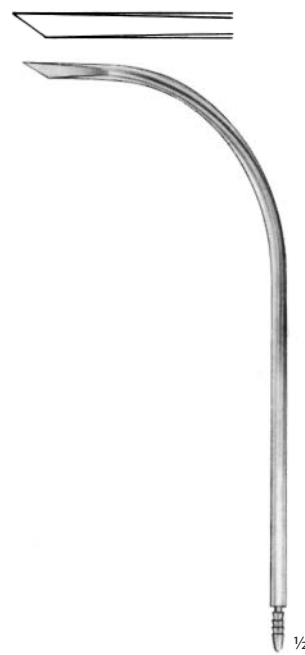

		Ø
<b>134 91 0147</b>	8 Charr.	2 2/3 mm
<b>134 91 0148</b>	10 Charr.	3 1/3 mm
<b>134 91 0149</b>	12 Charr.	4 mm
<b>134 91 0150</b>	14 Charr.	4 2/3 mm
<b>134 91 0151</b>	16 Charr.	5 1/3 mm
<b>134 91 0152</b>	18 Charr.	6 mm

JEHLY INJEKČNÍ  
HYPODERMIC NEEDLES



**PRAVAZ (LUER-LOCK)**

balení 12 ks  
packing 12 pcs

<b>418-598-010</b>	Fig. 1	Ø 0,90 × 38 mm
<b>418-598-020</b>	Fig. 2	Ø 0,80 × 32 mm
<b>418-598-120</b>	Fig. 12	Ø 0,70 × 32 mm
<b>418-598-140</b>	Fig. 14	Ø 0,65 × 28 mm
<b>418-598-160</b>	Fig. 16	Ø 0,60 × 25 mm
<b>418-598-180</b>	Fig. 18	Ø 0,50 × 23 mm
<b>418-598-200</b>	Fig. 20	Ø 0,45 × 20 mm

**JEHLY NA BIOPSII**  
**BIOPSY NEEDLES**
**QUINKE**

<b>322-230-070</b>	0,7 × 50 mm
<b>322-226-070</b>	0,7 × 76 mm
<b>322-228-070</b>	0,7 × 89 mm
<b>322-226-100</b>	1,0 × 76 mm
<b>322-228-100</b>	1,0 × 89 mm
<b>322-226-120</b>	1,2 × 76 mm
<b>322-228-120</b>	1,2 × 89 mm

**TUOHY**

<b>418-628-120</b>	1,20 × 76 mm
<b>418-628-140</b>	1,40 × 76 mm
<b>418-628-160</b>	1,60 × 76 mm

**BIER**

<b>322-232-100</b>	1,0 × 80 mm
<b>322-232-120</b>	1,2 × 80 mm
<b>322-232-150</b>	1,5 × 80 mm
<b>322-232-180</b>	1,8 × 80 mm

**MENGHINI**

<b>38-420-001</b>	1,0 × 35 mm
<b>38-420-002</b>	1,0 × 70 mm
<b>38-420-003</b>	1,2 × 70 mm
<b>38-420-004</b>	1,2 × 100 mm
<b>38-420-005</b>	1,4 × 70 mm
<b>38-420-006</b>	1,4 × 100 mm
<b>38-420-007</b>	1,6 × 70 mm
<b>38-420-008</b>	1,8 × 100 mm

**MENGHINI**

<b>38-430-140</b>	1,4 × 168 mm
<b>38-430-180</b>	1,8 × 168 mm



Jehla na mandle  
Tonsil needle  
**350-288-000**  
přímá  
straight  
Ø 0,8 mm



Jehla na mandle  
Tonsil needle  
**350-289-900**  
zahnutá 90°  
curved  
Ø 0,8 mm



Jehla na nosní přepážku  
Septum needle  
**350-289-000**  
bajonetová  
bayonet  
Ø 0,8 mm



Jehla na nosní přepážku  
Septum needle  
**350-289-450**  
lomená 45°  
angled on flat  
Ø 0,8 mm

ODSÁVAČKY  
SUCTION TUBES



**MAGILL**  
24,5 cm

	Ø
<b>304-151-300</b>	3,0 mm
<b>304-151-350</b>	3,5 mm
<b>304-151-400</b>	4,0 mm

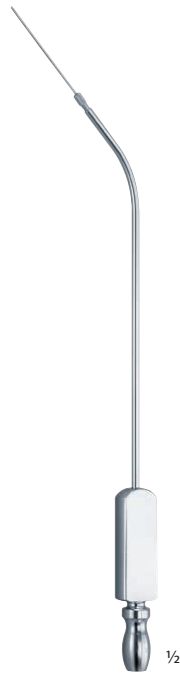

**ZÖLLNER**  
**344-095-000**  
Ø 0,7 mm  
komplet s kanylou  
complete with 1 slip-on cannula



**IOWA**  
**344-090-160**  
16,0 cm  
Ø 0,7 mm

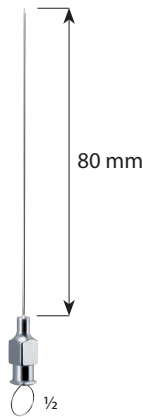

**ROSEN**  
rovná  
straight

	Ø
<b>38-572-005</b>	0,5 mm
<b>38-572-006</b>	0,6 mm
<b>38-572-007</b>	0,7 mm
<b>38-572-009</b>	0,9 mm
<b>38-572-010</b>	1,0 mm
<b>38-572-012</b>	1,2 mm
<b>38-572-014</b>	1,4 mm
<b>38-572-015</b>	1,5 mm
<b>38-572-018</b>	1,8 mm
<b>38-572-020</b>	2,0 mm
<b>38-572-025</b>	2,5 mm
<b>38-572-030</b>	3,0 mm

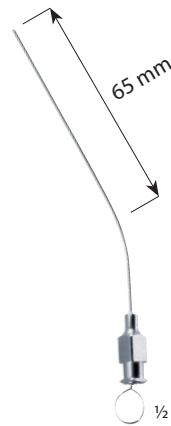

**ROSEN**  
lomená  
angled

	Ø
<b>38-573-005</b>	0,5 mm
<b>38-573-006</b>	0,6 mm
<b>38-573-007</b>	0,7 mm
<b>38-573-009</b>	0,9 mm
<b>38-573-010</b>	1,0 mm
<b>38-573-012</b>	1,2 mm
<b>38-573-014</b>	1,4 mm
<b>38-573-015</b>	1,5 mm
<b>38-573-018</b>	1,8 mm
<b>38-573-020</b>	2,0 mm
<b>38-573-025</b>	2,5 mm
<b>38-573-030</b>	3,0 mm



**BARON**

	L		Ø
<b>344-097-030</b>	75 mm	3 Charr./Fr.	1 mm
<b>344-097-050</b>	75 mm	5 Charr./Fr.	1,66 mm
<b>344-097-070</b>	75 mm	7 Charr./Fr.	2,33 mm
<b>344-097-030/L</b>	100 mm	3 Charr./Fr.	1 mm
<b>344-097-050/L</b>	100 mm	5 Charr./Fr.	1,66 mm
<b>344-097-070/L</b>	100 mm	7 Charr./Fr.	2,33 mm



**HOUSE**

	L	Ø
<b>344-099-010</b>	90 mm	0,9 × 0,7 mm
<b>344-099-020</b>	90 mm	1,2 × 0,9 mm
<b>344-099-030</b>	90 mm	1,5 × 1,2 mm
<b>344-099-040</b>	90 mm	1,8 × 1,8 mm
<b>344-099-050</b>	90 mm	2,5 × 2,0 mm
<b>344-099-060</b>	90 mm	3,0 × 2,0 mm
<b>344-099-070</b>	90 mm	4,5 × 2,0 mm



**FERGUSSON**

17,0 cm

		Ø
<b>418-515-020</b>	6 Charr./Fr.	2 mm
<b>418-515-025</b>	8 Charr./Fr.	2 ⅜ mm
<b>418-515-030</b>	9 Charr./Fr.	3 mm
<b>418-515-035</b>	10 Charr./Fr.	3 ½ mm
<b>418-515-040</b>	12 Charr./Fr.	4 mm
<b>418-515-050</b>	15 Charr./Fr.	5 mm

**ODSÁVAČKY, ODSÁVACÍ A PROPLACHOVACÍ KANYLY**  
**SUCTION TUBES, SUCTION AND IRRIGATION CANNULAE**
**EICKEN**lehce zahnutá  
slightly curved

Ø

<b>38-687-025</b>	2,5 mm
<b>38-687-030</b>	3,0 mm
<b>38-687-040</b>	4,0 mm

**EICKEN**silně zahnutá  
strongly curved

Ø

<b>38-689-025</b>	2,5 mm
<b>38-689-030</b>	3,0 mm
<b>38-689-040</b>	4,0 mm

**LUER-LOCK****38-591-030**  
Ø 3,0 mm**ADSON**

			Ø
<b>340-286-140</b>	140 mm	9 Charr./Fr.	3 mm
<b>340-286-210</b>	210 mm	12 Charr./Fr.	4 mm
<b>340-286-211</b>	210 mm	15 Charr./Fr.	5 mm

**PLESTER**

			Ø
<b>18-517-015</b>	5 Charr./Fr.	1,6 mm	
<b>18-517-020</b>	6 Charr./Fr.	2,0 mm	
<b>18-517-025</b>	8 Charr./Fr.	2,33 mm	
<b>18-517-030</b>	9 Charr./Fr.	3,0 mm	

**FRAZIER**

			Ø
<b>38-571-006</b>	6 Charr./Fr.	2 mm	
<b>340-291-070</b>	7 Charr./Fr.	2 ½ mm	
<b>38-571-008</b>	8 Charr./Fr.	2 ⅔ mm	
<b>340-291-090</b>	9 Charr./Fr.	3 mm	
<b>38-571-010</b>	10 Charr./Fr.	3 ½ mm	
<b>38-571-012</b>	12 Charr./Fr.	4 mm	
<b>340-291-150</b>	15 Charr./Fr.	5 mm	

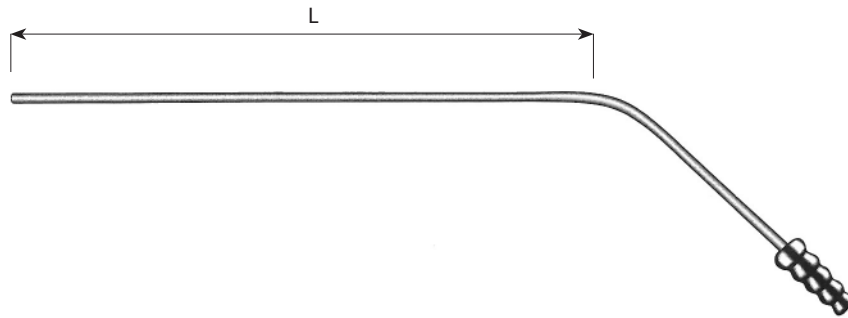

**YASARGIL**

	L	Ø
<b>J-14-054</b>	150 mm	1,5 mm
<b>J-14-055</b>	150 mm	2,0 mm
<b>J-14-057</b>	150 mm	2,5 mm
<b>J-14-058</b>	150 mm	3,5 mm

**KATÉTRY NA EUSTACHOVU TRUBICI**  
EUSTACHIAN CATHETERS



**EICKEN-KILLIAN**

	L	Ø
<b>38-685-020</b>	130 mm	2,0 mm
<b>38-685-025</b>	130 mm	2,5 mm
<b>38-685-030</b>	130 mm	3,0 mm
<b>38-685-040</b>	130 mm	4,0 mm

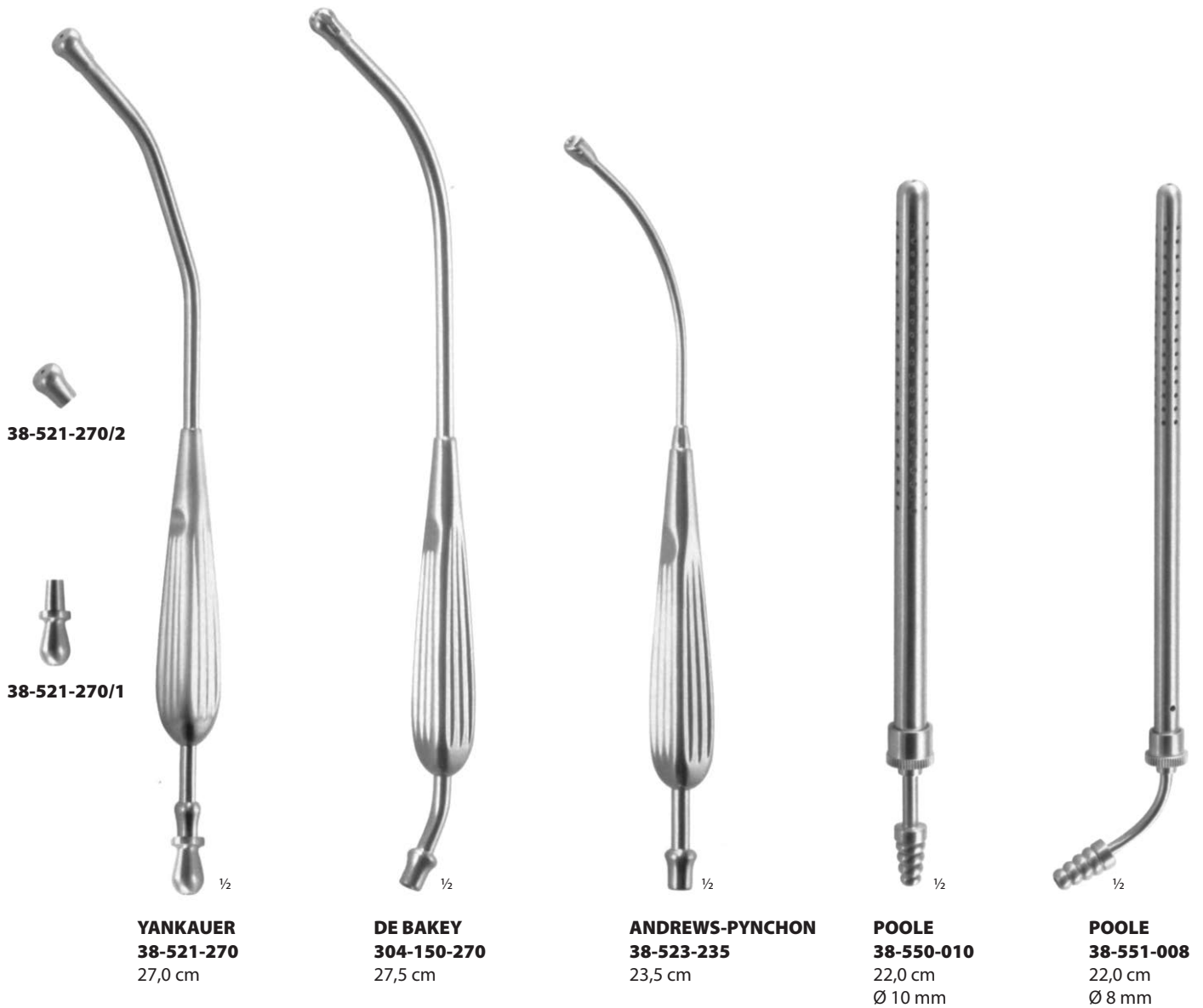



# 135

## DILATATORY DILATORS

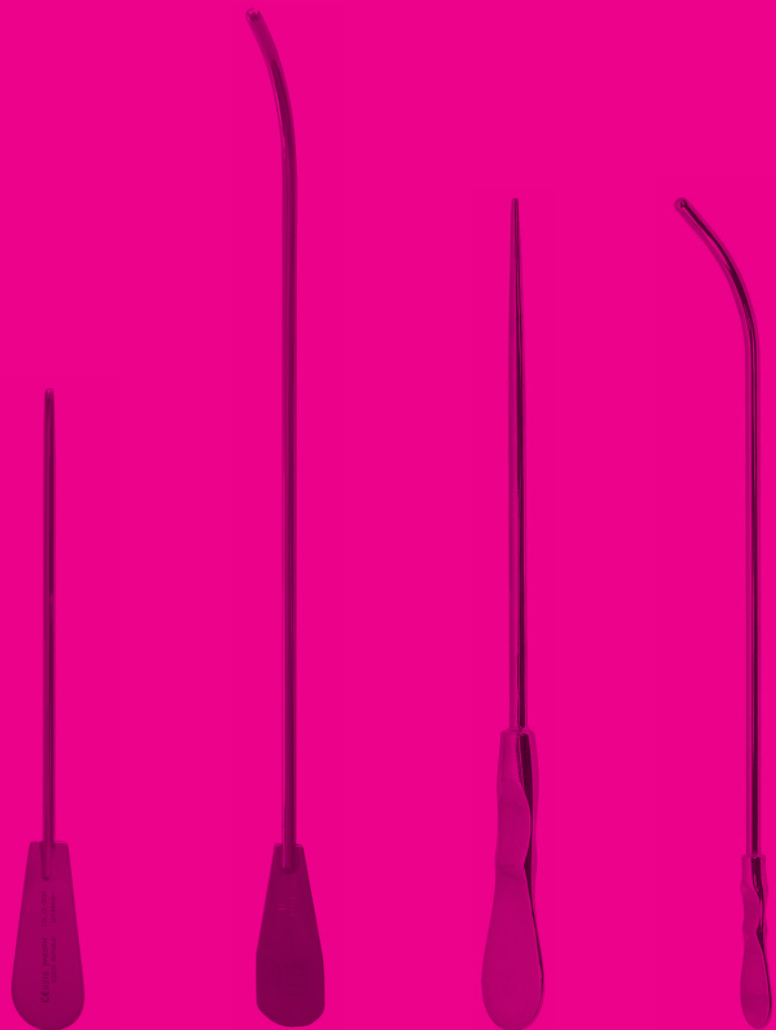





17,0 cm

	Ø	
<b>135 22 0010</b>	2 2/3 mm	8 Charr. / Fr.
<b>135 22 0020</b>	3 mm	9 Charr. / Fr.
<b>135 22 0030</b>	3 1/2 mm	10 Charr. / Fr.



27,0 cm

	Ø	
<b>135 22 0340</b>	3 mm	9 Charr. / Fr.
<b>135 22 0350</b>	3 1/2 mm	10 Charr. / Fr.
<b>135 22 0360</b>	3 3/4 mm	11 Charr. / Fr.
<b>135 22 0370</b>	4 mm	12 Charr. / Fr.

DILATÁTORY UROLOGICKÉ  
UROLOGICAL DILATORS**DITTEL**rovný  
straight  
22,0 cm

	Ø	
<b>60-330-008</b>	2 ½ mm	8 Charr. / Fr.
<b>431-576-090</b>	3 mm	9 Charr. / Fr.
<b>60-330-010</b>	3 ½ mm	10 Charr. / Fr.
<b>431-576-110</b>	3 ¾ mm	11 Charr. / Fr.
<b>60-330-012</b>	4 mm	12 Charr. / Fr.
<b>431-576-130</b>	4 ½ mm	13 Charr./Fr.
<b>60-330-014</b>	4 ¾ mm	14 Charr. / Fr.
<b>431-576-150</b>	5 mm	15 Charr. / Fr.
<b>60-330-016</b>	5 ½ mm	16 Charr. / Fr.
<b>431-576-170</b>	5 ¾ mm	17 Charr. / Fr.
<b>60-330-018</b>	6 mm	18 Charr. / Fr.
<b>431-576-190</b>	6 ½ mm	19 Charr. / Fr.
<b>60-330-020</b>	6 ¾ mm	20 Charr. / Fr.
<b>431-576-210</b>	7 mm	21 Charr. / Fr.
<b>60-330-022</b>	7 ½ mm	22 Charr. / Fr.
<b>431-576-230</b>	7 ¾ mm	23 Charr. / Fr.
<b>60-330-024</b>	8 mm	24 Charr. / Fr.
<b>431-576-250</b>	8 mm	25 Charr. / Fr.
<b>60-330-026</b>	8 ¾ mm	26 Charr. / Fr.
<b>431-576-270</b>	9 mm	27 Charr. / Fr.
<b>60-330-028</b>	9 ½ mm	28 Charr. / Fr.
<b>431-576-290</b>	9 ¾ mm	29 Charr. / Fr.
<b>60-330-030</b>	10 mm	30 Charr. / Fr.
<b>431-576-320</b>	10 mm	32 Charr. / Fr.

**431-576-000**Set 23 kusů, 8–30 Charr. / Fr.  
Set 23 pieces, 8–30 Charr. / Fr.**DITTEL**zahnutý  
curved  
22,0 cm

	Ø	
<b>60-335-008</b>	2 ½ mm	8 Charr. / Fr.
<b>60-335-009</b>	3 mm	9 Charr. / Fr.
<b>60-335-010</b>	3 ½ mm	10 Charr. / Fr.
<b>60-335-011</b>	3 ¾ mm	11 Charr. / Fr.
<b>60-335-012</b>	4 mm	12 Charr. / Fr.
<b>60-335-013</b>	4 ½ mm	13 Charr. / Fr.
<b>60-335-014</b>	4 ¾ mm	14 Charr. / Fr.
<b>60-335-015</b>	5 mm	15 Charr. / Fr.
<b>60-335-016</b>	5 ½ mm	16 Charr. / Fr.
<b>60-335-017</b>	5 ¾ mm	17 Charr. / Fr.
<b>60-335-018</b>	6 mm	18 Charr. / Fr.
<b>60-335-019</b>	6 ½ mm	19 Charr. / Fr.
<b>60-335-020</b>	6 ¾ mm	20 Charr. / Fr.
<b>60-335-021</b>	7 mm	21 Charr. / Fr.
<b>60-335-022</b>	7 ½ mm	22 Charr. / Fr.
<b>60-335-023</b>	7 ¾ mm	23 Charr. / Fr.
<b>60-335-024</b>	8 mm	24 Charr./Fr.
<b>60-335-025</b>	8 ½ mm	25 Charr. / Fr.
<b>60-335-026</b>	8 ¾ mm	26 Charr. / Fr.
<b>60-335-027</b>	9 mm	27 Charr. / Fr.
<b>60-335-028</b>	9 ½ mm	28 Charr. / Fr.
<b>60-335-029</b>	9 ¾ mm	29 Charr. / Fr.
<b>60-335-030</b>	10 mm	30 Charr. / Fr.

**60-335-000**Set 23 kusů, 8–30 Charr./Fr.  
Set 23 pieces, 8–30 Charr. / Fr.

**GUYON**

	Ø	
<b>366-201-080</b>	2 2/3 mm	8 Charr. / Fr.
<b>366-201-100</b>	3 1/2 mm	10 Charr. / Fr.
<b>366-201-110</b>	3 3/4 mm	11 Charr. / Fr.
<b>366-201-120</b>	4 mm	12 Charr. / Fr.
<b>366-201-130</b>	4 1/2 mm	13 Charr. / Fr.
<b>366-201-140</b>	4 3/4 mm	14 Charr. / Fr.
<b>366-201-150</b>	5 mm	15 Charr. / Fr.
<b>366-201-160</b>	5 1/2 mm	16 Charr. / Fr.
<b>366-201-170</b>	5 3/4 mm	17 Charr. / Fr.
<b>366-201-180</b>	6 mm	18 Charr. / Fr.
<b>366-201-190</b>	6 1/2 mm	19 Charr. / Fr.
<b>366-201-200</b>	6 3/4 mm	20 Charr. / Fr.
<b>366-201-210</b>	7 mm	21 Charr. / Fr.
<b>366-201-220</b>	7 1/2 mm	22 Charr. / Fr.
<b>366-201-230</b>	7 3/4 mm	23 Charr. / Fr.
<b>366-201-240</b>	8 mm	24 Charr. / Fr.
<b>366-201-250</b>	8 1/2 mm	25 Charr. / Fr.
<b>366-201-260</b>	8 3/4 mm	26 Charr. / Fr.
<b>366-201-270</b>	9 mm	27 Charr. / Fr.
<b>366-201-280</b>	9 1/2 mm	28 Charr. / Fr.
<b>366-201-290</b>	9 3/4 mm	29 Charr. / Fr.
<b>366-201-300</b>	10 mm	30 Charr. / Fr.
<b>366-201-310</b>	10 1/2 mm	31 Charr. / Fr.
<b>366-201-320</b>	10 3/4 mm	32 Charr. / Fr.
<b>366-201-330</b>	11 mm	33 Charr. / Fr.
<b>366-201-340</b>	11 1/2 mm	34 Charr. / Fr.
<b>366-201-350</b>	11 3/4 mm	35 Charr. / Fr.
<b>366-201-360</b>	12 mm	36 Charr. / Fr.
<b>366-201-370</b>	12 1/2 mm	37 Charr. / Fr.
<b>366-201-380</b>	12 3/4 mm	38 Charr. / Fr.
<b>366-201-390</b>	13 mm	39 Charr. / Fr.
<b>366-201-400</b>	13 1/2 mm	40 Charr. / Fr.



**VAN BUREN**

	Ø	
<b>60-321-008</b>	2 2/3 mm	8 Charr. / Fr.
<b>60-321-010</b>	3 1/2 mm	10 Charr. / Fr.
<b>60-321-012</b>	4 mm	12 Charr. / Fr.
<b>60-321-014</b>	4 1/2 mm	14 Charr. / Fr.
<b>60-321-016</b>	5 1/2 mm	16 Charr. / Fr.
<b>60-321-018</b>	6 mm	18 Charr. / Fr.
<b>60-321-020</b>	6 1/2 mm	20 Charr. / Fr.
<b>60-321-022</b>	7 1/2 mm	22 Charr. / Fr.
<b>60-321-024</b>	8 mm	24 Charr. / Fr.
<b>60-321-026</b>	8 1/2 mm	26 Charr. / Fr.
<b>60-321-028</b>	9 1/2 mm	28 Charr. / Fr.
<b>60-321-030</b>	10 1/2 mm	30 Charr. / Fr.
<b>60-321-032</b>	10 mm	32 Charr. / Fr.
<b>60-321-034</b>	11 1/2 mm	34 Charr. / Fr.
<b>60-321-036</b>	12 mm	36 Charr. / Fr.

**60-321-000**

Set 15 kusů, 8–36 Charr. / Fr.

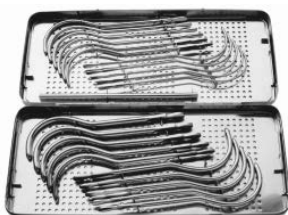
Set 15 pieces, 8–36 Charr. / Fr.

**GUYON**
**366-196-000**

Set 21 kusů, 10–30 Charr., v kovové krabičce

Set 21 pieces, 10–30 Charr., in steel case

420 × 175 mm × 40 mm



Katetr kovový, pro ženy  
Metal catheter for women  
15,0 cm

<b>60-441-008</b>	2 ⅜ mm	8 Charr. / Fr.
<b>60-441-010</b>	3 ⅜ mm	10 Charr. / Fr.
<b>60-441-012</b>	4 mm	12 Charr. / Fr.
<b>60-441-014</b>	4 ⅜ mm	14 Charr. / Fr.
<b>60-441-016</b>	5 ⅜ mm	16 Charr. / Fr.
<b>60-441-018</b>	6 mm	18 Charr. / Fr.
<b>60-441-020</b>	6 ⅜ mm	20 Charr. / Fr.
<b>60-441-022</b>	7 ⅜ mm	22 Charr. / Fr.
<b>60-441-024</b>	8 mm	24 Charr. / Fr.



Katetr kovový, pro muže  
Metal catheter for men  
27,0 cm

<b>60-421-008</b>	2 ⅜ mm	8 Charr. / Fr.
<b>60-421-010</b>	3 ⅜ mm	10 Charr. / Fr.
<b>60-421-012</b>	4 mm	12 Charr. / Fr.
<b>60-421-014</b>	4 ⅜ mm	14 Charr. / Fr.
<b>60-421-016</b>	5 ⅜ mm	16 Charr. / Fr.
<b>60-421-018</b>	6 mm	18 Charr. / Fr.
<b>60-421-020</b>	6 ⅜ mm	20 Charr. / Fr.
<b>60-421-022</b>	7 ⅜ mm	22 Charr. / Fr.
<b>60-421-024</b>	8 mm	24 Charr. / Fr.



**OTIS**  
**60-782-000**  
komplet, v dřevěné krabičce  
dilátor, 2 nože, 3 hroty  
complete in wooden case  
with dilator, 2 knives and 3 tips



Náhradní čepel  
Spare blade  
**60-782-001**





# 136

**SPECIÁLNÍ NÁSTROJE**  
SPECIAL INSTRUMENTS





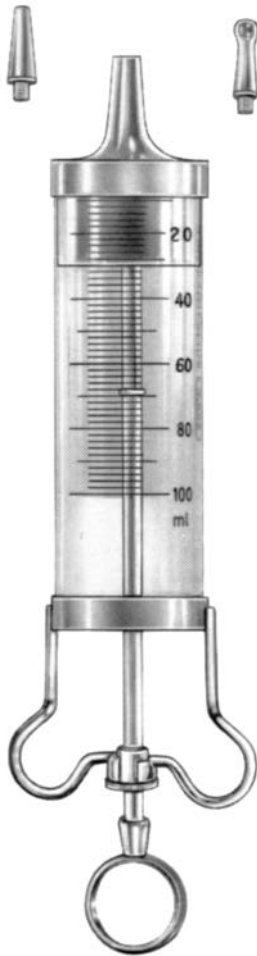

**JANET**

- 136 91 0153** 50 ml
- 136 91 0154** 100 ml
- 136 91 0155** 150 ml
- 136 91 0156** 200 ml



- 136 91 0157** 50 ml
- 136 91 0158** 100 ml
- 136 91 0159** 150 ml
- 136 91 0160** 200 ml

NÁSTROJE NA PROTĚTÍ VAZU  
INSTRUMENTS FOR LIGAMENT CUTTING

Háček  
Hook  
**136 17 0140**  
21,0 cm



Nůž trojúhelníkový  
Triangular knife  
**136 17 0150**  
21,0 cm



Nůž háčkový  
Hooked knife  
**136 17 0160**  
21,0 cm



Pouzdro vodící  
Guide sleeve  
**136 17 0120**  
9,3 cm



Zavaděč pouzdra vodícího  
Guide for sleeve  
**136 17 0130**  
19,9 cm



Gumový o-kroužek k aplikátoru  
Gum o-ring for applicator

**115 91 0578**

100 ks/pcs

**115 91 0579**

komplet  
Ø 10 mm

**TOULCE S PODSTAVCEM**  
 QUIVERS WITH STAND

**136 39 0050**  
70×110 mm  
na pinzety  
for tweezers



**136 39 0060**  
70×200 mm  
na kleště  
for forceps



**136 39 0070**  
50×90 mm  
na pinzety  
for tweezers



	průměr × výška diameter × height
<b>136 91 0072</b>	3,0 × 9,0 cm
<b>136 91 0070</b>	5,0 × 10,0 cm
<b>136 91 0073</b>	5,0 × 13,0 cm
<b>136 91 0074</b>	5,0 × 17,5 cm
<b>136 91 0075</b>	7,5 × 10,0 cm
<b>136 91 0076</b>	7,5 × 13,0 cm
<b>136 91 0071</b>	7,5 × 17,5 cm

**TOULCE**  
 QUIVERS

**136 39 0010**  
4,7×9,0 cm  
na pinzety  
for tweezers



**136 39 0020**  
6,6×20,0 cm  
na podávkové kleště  
for forceps



průměr × výška  
diameter × height

<b>136 91 0077</b>	0,05 l	4,0 × 1,9 cm
<b>136 91 0078</b>	0,07 l	6,1 × 3,0 cm
<b>136 91 0079</b>	0,14 l	8,0 × 4,0 cm
<b>136 91 0080</b>	0,35 l	11,6 × 5,0 cm
<b>136 91 0081</b>	0,45 l	12,8 × 5,5 cm
<b>136 91 0082</b>	0,70 l	14,7 × 6,5 cm



průměr × výška  
diameter × height

<b>136 91 0109</b>	0,75 l	16,5 × 6,0 cm
<b>136 91 0110</b>	1,0 l	17,5 × 7,0 cm
<b>136 91 0111</b>	2,0 l	22,0 × 8,0 cm
<b>136 91 0113</b>	3,0 l	24,0 × 11,0 cm
<b>136 91 0114</b>	4,5 l	27,5 × 11,5 cm
<b>136 91 0115</b>	6,0 l	29,0 × 12,5 cm
<b>136 91 0116</b>	6,0 l	31,0 × 12,0 cm
<b>136 91 0117</b>	8,5 l	34,5 × 12,5 cm
<b>136 91 0118</b>	11,0 l	38,0 × 13,0 cm

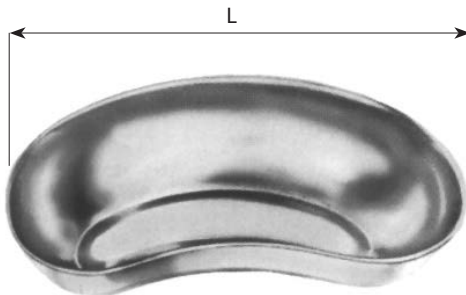

L

<b>136 91 0087</b>	17,0 cm
<b>136 91 0088</b>	25,0 cm
<b>136 91 0089</b>	27,5 cm



<b>136 91 0083</b>	0,25 l
<b>136 91 0084</b>	0,50 l
<b>136 91 0085</b>	1,00 l

SPONY NA NÁSTROJE  
SAFETY PINS

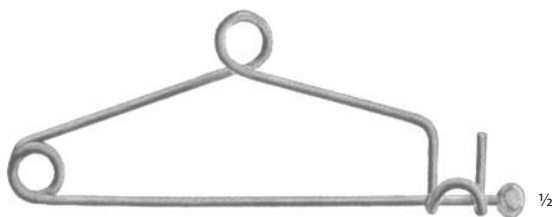

**MAYO**  
**136 91 0128**  
14,0 cm

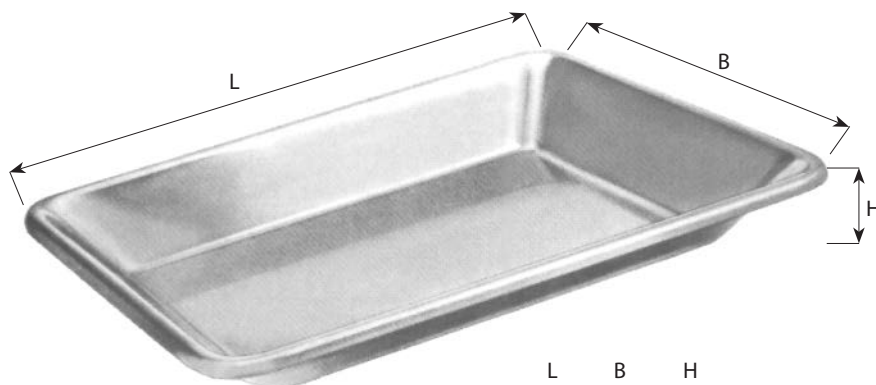

**MAYO**  
**136 91 0129**  
14,0 cm

TÁCY UNIVERZÁLNÍ  
UNIVERSAL TRAYS

	L	B	H
<b>136 91 0097</b>	23,0	15,5	3,0
<b>136 91 0098</b>	30,0	17,5	3,0
<b>136 91 0099</b>	30,0	17,5	4,0
<b>136 91 0100</b>	35,0	24,0	3,6
<b>136 91 0101</b>	40,0	30,0	5,0

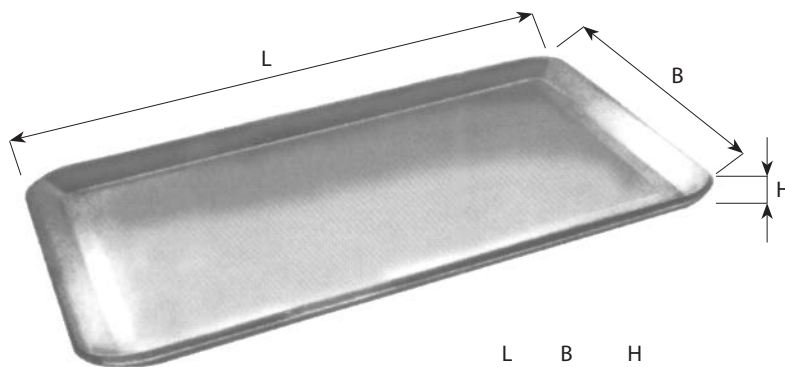

	L	B	H
<b>136 91 0102</b>	21,0	16,0	1,0
<b>136 91 0103</b>	24,0	18,0	1,0
<b>136 91 0104</b>	31,0	15,0	1,0
<b>136 91 0105</b>	31,0	21,0	1,0
<b>136 91 0106</b>	35,0	24,0	1,0
<b>136 91 0107</b>	40,0	27,0	2,0
<b>136 91 0108</b>	42,0	28,0	1,0





**139 39 0010**  
Fig.1  
50,0 × 30,0 × 3 cm



**139 39 0040**  
Fig.4  
50,0 × 30,0 × 6 cm



**139 39 0020**  
Fig.2  
30,0 × 23,0 × 3 cm



**139 39 0030**  
Fig.3  
30,0 × 15,0 × 3 cm



	L	B	H
<b>136 91 0036</b>	16,5	9,0	3,5
<b>136 91 0037</b>	20,0	10,0	5,0
<b>136 91 0038</b>	22,0	15,0	5,0
<b>136 91 0039</b>	26,0	15,0	5,0
<b>136 91 0040</b>	30,5	20,5	5,0

KRABIČKY PRO HORKOVZDUŠNOU STERILIZACI  
BOXES FOR DRY-HEAT STERILIZATION

**136 39 0140**  
nerez – stainless steel  
200×100×30 mm



**136 39 0150**  
nerez – stainless steel  
170×70×30 mm



**136 39 0160**  
nerez – stainless steel  
200×100×40 mm



**136 39 0170**  
nerez – stainless steel  
210×115×45 mm



**136 39 0180**  
nerez – stainless steel  
dvojití víčko – double lid  
210×110×25 mm



**136 39 0190**  
nerez – stainless steel  
210×115×45 mm



**136 39 0200**  
nerez – stainless steel  
na katetry – for catheters  
300×80×40 mm



**136 39 0220**  
nerez – stainless steel  
350×90×50 mm



**136 39 0230**  
nerez – stainless steel  
230×150×60 mm



**136 39 0240**  
nerez – stainless steel  
300×200×50 mm



**136 39 0250**  
nerez – stainless steel  
200×150×45 mm

POZNÁMKY: vnitřní rozměry  
NOTES: inner dimensions



**136 39 0211** 65 × 15 mm



**136 39 0212** 62 × 13 mm

**136 39 0213** 40 × 13 mm

**136 39 0214** 80 × 18 mm

**136 39 0215** 90 × 20 mm

**136 39 0216** 100 × 20 mm

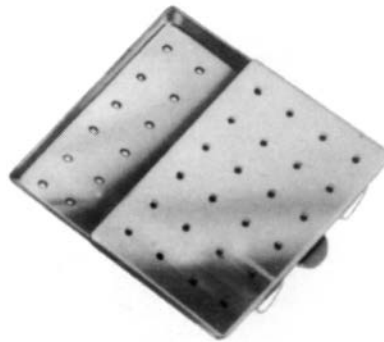

**136 91 0092** 5,0 × 2,5 × 0,45 cm

**136 91 0093** 6,5 × 4,2 × 8,0 cm

**136 91 0094** 7,5 × 2,5 × 0,45 cm



**136 91 0096**  
15,0 × 9,5 × 1,3 cm





**NÁSTROJE PRO ORL**  
**INSTRUMENTS FOR ENT**





MEDIN, a.s.  
Vlachovická 619  
Nové Město na Moravě  
CZ 592 31  
Czech Republic  
IČO: 43378030  
DIČ: CZ43378030

**CENTRÁLA**  
tel.: 566 684 111

**PRODEJ ČESKÁ REPUBLIKA**  
tel.: 566 684 327  
fax: 566 684 384  
e-mail: prodej@medin.cz

**EXPORT**  
phone: +420 566 684 250  
fax: +420 566 684 385  
e-mail: export@medin.cz

**[www.medin.cz](http://www.medin.cz)**

MEDIN Slovensko, s.r.o.  
Mlynská 10  
Piešťany  
SK 921 01  
Slovak Republic  
IČO: 46540873  
SK DPH: SK2023412688

tel.: +421 337 746 259  
fax: +421 337 746 153  
e-mail: jana.snajdarova@medin.sk

**[www.medin.sk](http://www.medin.sk)**

<b>397 111</b>	<b>Diagnostika</b>	Diagnostic	361–394
<b>397 112</b>	<b>Nástroje řezné</b>	Cutting Instruments	365–371
<b>397 113</b>	<b>Nůžky</b>	Scissors	372–373
<b>397 116</b>	<b>Kleště štípací</b>	Bone Rongeurs	374–387
<b>397 117</b>	<b>Kleště úchopné</b>	Grasping Forceps	388–393
<b>397 118</b>	<b>Háky</b>	Hooks, Retractors	394–396
<b>397 119</b>	<b>Rozvěrače</b>	Retractors	397–398
<b>397 121</b>	<b>Lopatky</b>	Spatulas	399–400
<b>397 122</b>	<b>Zrcadla</b>	Specula	401–406
<b>397 123</b>	<b>Páčidla</b>	Elevators	407–410
<b>397 124</b>	<b>Škrabky</b>	Raspatories	411
<b>397 125</b>	<b>Lžičky</b>	Spoons	412
<b>397 126</b>	<b>Kyrety</b>	Curettes	413–417
<b>397 127</b>	<b>Pilky, pilníky</b>	Saws, Files	418–423
<b>397 128</b>	<b>Dláta</b>	Chisels	424–428
<b>397 131</b>	<b>Frézy</b>	Cutters, Burs	429–430
<b>397 133</b>	<b>Pátradla</b>	Probes	431
<b>397 139</b>	<b>Soubory</b>	Sets	432–435



**POZNÁMKA:**

Katalogová čísla MEDIN jsou v katalogu uvedena ve zkrácené podobě bez předčísí pro zdravotnické prostředky.

Například: katalogové číslo / objednáací číslo  
XXX XX XXXX / 397XXXXXXXXX

Aktuální konverzní tabulku nebo ceník s kompletními objednáacími čísly si vyžádejte u svého obchodního zástupce.

**NOTE:**

MEDIN catalogue numbers in this catalogue are listed in short form without the prefix for medical devices.

For example: catalogue number / order number  
XXX XX XXXX / 397XXXXXXXXX

Ask your sales representative for the up-to-date conversion table or the price list with complete ordering numbers.

© 2018 MEDIN, a.s.; Všechna práva vyhrazena.

Dokument je určen pro obchodní účely MEDIN, a.s., údaje zde uvedené jsou informativního charakteru.

Žádná část tohoto dokumentu nesmí být reprodukována nebo publikována v jakékoliv formě bez předchozího souhlasu MEDIN, a.s. Zobrazení produktů odpovídá aktuálnímu stavu v době vydání tohoto dokumentu. Změny technických parametrů z důvodu dalšího vývoje jsou vyhrazeny.

Tiskové a typografické chyby jsou vyhrazeny.

© 2018 MEDIN, a.s.; All rights reserved.

This document should be used for commercial purposes of MEDIN, a.s.; the data mentioned in the document has informative character. No part of this document can be copied or published in any form without approval of MEDIN, a.s.

The product design may differ from those depicted in these illustrations at the date of issue. Adjustments, made from the reason of further developments of technical parameters, are reserved.

Printing and typographical errors are reserved.





1/2

**111 91 0140**

**POLITZER**  
**111 91 0139**  
komplet  
complete

**111 91 0140**  
**111 91 0141**  
**111 91 0142**  
**111 91 0143**  
**111 91 0144**



1/2

**111 91 0144**



1/2

<b>111 91 0141</b>	∅ 15 mm
<b>111 91 0142</b>	17 mm
<b>111 91 0143</b>	22 mm

∅  
15 mm  
17 mm  
22 mm

**ZAPRAŠOVAČ**  
**POWDER BLOWER**

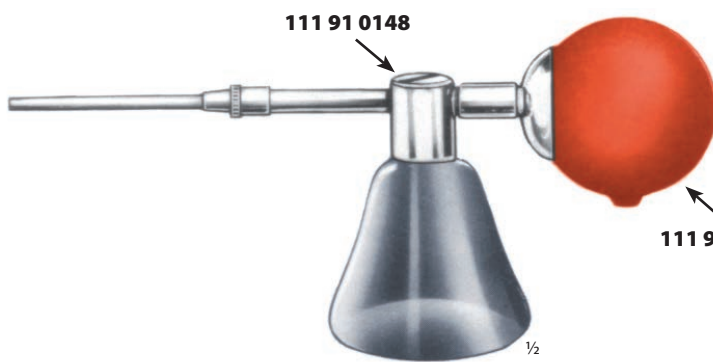

**111 91 0148**

**111 91 0146**

**111 91 0147**  
30 ccm

1/2

**KABIERSKE**  
**111 91 0145**  
komplet  
complete

**111 91 0146**  
**111 91 0147**  
**111 91 0148**  
**111 91 0149**  
**111 91 0150**  
**111 91 0151**



1/2

**111 91 0149**  
8,0 cm



1/2

**111 91 0150**  
11,0 cm

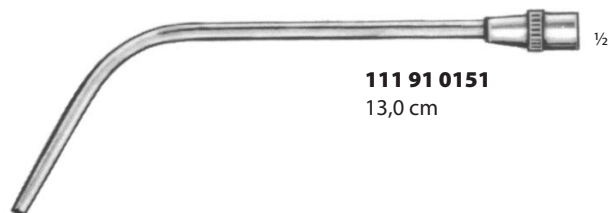

1/2

**111 91 0151**  
13,0 cm



1/2

**HARTMANN**

<b>111 91 0111</b>	C	128
<b>111 91 0112</b>	C <sup>1</sup>	256
<b>111 91 0113</b>	C <sup>2</sup>	512
<b>111 91 0114</b>	C <sup>3</sup>	1024
<b>111 91 0115</b>	C <sup>4</sup>	2048
<b>111 91 0116</b>	C <sup>5</sup>	4096



1/2

**LUCAE**

<b>111 91 0117</b>	C	128
<b>111 91 0118</b>	C <sup>1</sup>	256
<b>111 91 0119</b>	C <sup>2</sup>	512
<b>111 91 0120</b>	C <sup>3</sup>	1024
<b>111 91 0121</b>	C <sup>4</sup>	2048
<b>111 91 0122</b>	C <sup>5</sup>	4096



1/2

**HARTMANN-FRENCH**

<b>111 91 0123</b>	C <sup>2</sup>	16
<b>111 91 0124</b>	C <sup>2</sup>	32
<b>111 91 0125</b>	C	64
<b>111 91 0126</b>	C	128
<b>111 91 0127</b>	C <sup>1</sup>	256



**111 91 0128**  
sada – set  
**111 91 0113**  
**111 91 0114**  
**111 91 0115**  
**111 91 0126**  
**111 91 0127**

**111 91 0129**  
sada – set  
**111 91 0113**  
**111 91 0114**  
**111 91 0115**  
**111 91 0116**  
**111 91 0126**  
**111 91 0127**

**111 91 0130**  
sada – set  
**111 91 0113**  
**111 91 0114**  
**111 91 0115**  
**111 91 0116**  
**111 91 0124**  
**111 91 0125**  
**111 91 0126**  
**111 91 0127**

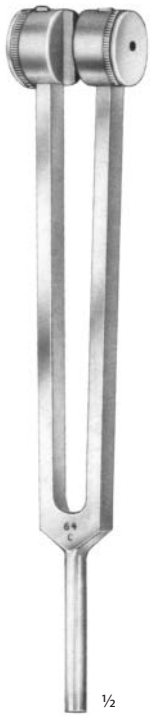

**111 91 0131**  
C 64



**111 91 0132**  
C 128



**111 91 0133**  
C 256



**111 91 0134**  
C 512



**111 91 0135**  
C 1024



**111 91 0136**  
C 2048



**111 91 0137**  
C 4096



**111 91 0138**  
sada – set  
**111 91 0132**  
**111 91 0133**  
**111 91 0134**  
**111 91 0135**  
**111 91 0136**

LAMPA ČELNÍ  
HEADLAMP**00-21360-00**

pro světelný kabel; koncovka Storz/RFQ  
bez kabelu

fiber optic deluxe; Storz/RFQ connection  
without cable



kabel objednejte zvlášť  
order cable separately

Světlovodný kabel HTT-Blue-Line  
Light cable HTT-Blue-Line

<b>00-22330-30</b>	Ø 3,5	1800 mm
<b>00-22330-40</b>	Ø 3,5	2300 mm
<b>00-22330-45</b>	Ø 3,5	2500 mm
<b>00-22330-50</b>	Ø 3,5	3000 mm
<b>00-22330-60</b>	Ø 3,5	4000 mm
<b>00-22330-70</b>	Ø 3,5	5000 mm



FOR CZECH AND SLOVAK  
DISTRIBUTION ONLY

## Adaptér k lampě čelní

Connecting headlamp adaptor

**00-21010-71**

RFQ/Storz/Wisap/Aesculap/  
Olympus standard/Innoview

## Barevná provedení kabelu

Color coded cables

SE	šedá	grey
MO	modrá	blue
CE	červená	red
ZL	žlutá	yellow
ZE	zelená	green
OR	oranžová	orange

Poznámka: Při objednávání kabelu  
připojte za objednávací číslo zkratku  
barevného provedení např.:  
00-22330-50 MO.

Note: For cable order use the ordering  
number and color code e.g.:  
00-22330-50 MO.

## Adaptéry ke světelným zdrojům

Connecting light source adaptors

	<b>00-21110-70</b>	RFQ/Storz/Wisap/Aesculap
	<b>00-21110-74</b>	Wolf/HSW/Dyonics/Medicon
	<b>00-21116-62</b>	Olympus/ACMI
	<b>00-21116-63</b>	Olympus/ACMI SPECIAL MODEL
	<b>00-21110-66</b>	ACM/British/Stryker
	<b>00-21119-60</b>	Volpi/Fot/Schölly
	<b>00-21119-62</b>	Fuji
	<b>00-21113-03</b>	Heine Optotechnik
	<b>00-21110-72</b>	Winter & Ibe
	<b>00-21113-06</b>	Schott/Zeiss (Kolposkop)
	<b>00-21119-65</b>	Pentax
	<b>00-21113-07</b>	Zeiss (OP Microscop)

ZRCADLA ČELNÍ  
HEAD MIRRORS

**111 91 0068** 90 mm

**111 91 0069** 100 mm

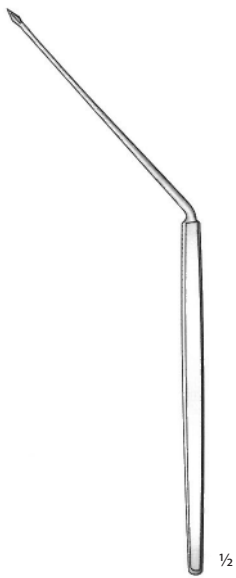

**AGNEW**  
**112 29 0010**  
16,5 cm

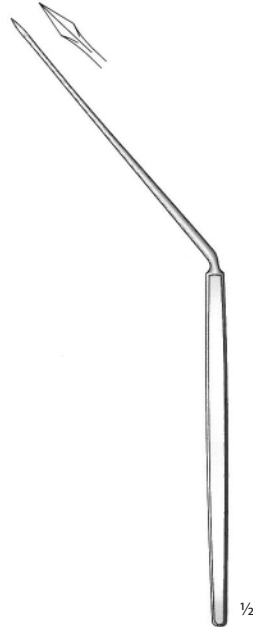

**SCHWARTZE**  
**112 29 0020**  
16,5 cm



**LUCAE**  
**112 29 0040**  
18,0 cm



**POLITZER**  
**112 91 0120**  
16,5 cm



**POLITZER**  
**112 91 0121**  
17,0 cm

**BARBARA**

25°

**112 91 0129** 0,3 mm**112 91 0130** 0,6 mm**112 91 0131** 1,0 mm**SHAMBAUGH**

45°

**112 91 0132** 0,3 mm**112 91 0133** 0,6 mm**112 91 0134** 1,0 mm**112 91 0135** 1,2 mm**112 91 0136** 1,5 mm**112 91 0137** 2,0 mm**112 91 0138** 2,5 mm**SHAMBAUGH**

90°

**112 91 0139** 0,3 mm**112 91 0140** 0,6 mm**112 91 0141** 1,0 mm**112 91 0142** 1,2 mm**112 91 0143** 1,5 mm**112 91 0144** 2,0 mm**112 91 0145** 2,5 mm**BARBARA****112 91 0146** 0,6 mm**112 91 0147** 1,0 mm

16,0 cm

**BARBARA****112 91 0148****BARBARA****112 91 0149****BARBARA****112 91 0150****ROSEN****112 91 0151**



25°  
**112 91 0152** 0,3 mm  
**112 91 0153** 0,6 mm  
**112 91 0154** 1,0 mm



45°  
**112 91 0158** 0,3 mm  
**112 91 0159** 0,6 mm  
**112 91 0160** 1,0 mm



90°  
**112 91 0164** 0,3 mm  
**112 91 0165** 0,6 mm  
**112 91 0166** 1,0 mm



16,0 cm



25°  
**112 91 0155** 0,3 mm  
**112 91 0156** 0,6 mm  
**112 91 0157** 1,0 mm



45°  
**112 91 0161** 0,3 mm  
**112 91 0162** 0,6 mm  
**112 91 0163** 1,0 mm



90°  
**112 91 0167** 0,3 mm  
**112 91 0168** 0,6 mm  
**112 91 0169** 1,0 mm



**McGEE**  
**112 91 0170** 0,5 mm  
**112 91 0171** 1,0 mm



**McGEE**  
**112 91 0172** 0,5 mm  
**112 91 0173** 1,0 mm



**BARBARA**  
**112 91 0174** 0,5 mm



**ROSEN**  
**112 91 0175** 0,5 mm



**ROSEN**  
16,0 cm



**112 91 0176**  
1 mm



**112 91 0177**  
1,4 mm

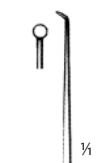

**112 91 0178**  
1,6 mm

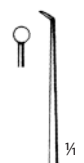

**112 91 0179**  
2 mm

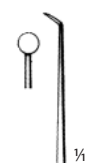

**112 91 0180**  
2,6 mm

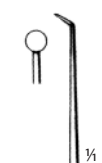

**112 91 0181**  
2,8 mm



**112 91 0182**  
3 mm



16,0 cm



**PLESTER**  
**112 91 0183**



**PLESTER**  
**112 91 0184**



**PLESTER**  
**112 91 0185**



**TABB**  
**112 91 0186**



**SCHUKNECHT**  
16,0 cm



**112 91 0187**



**112 91 0188**



**WULLSTEIN**  
**112 91 0189**  
16,0 cm



**SCHUKNECHT**  
**112 91 0190**  
16,0 cm





**POLITZER**  
**112 29 0110**  
17,0 cm

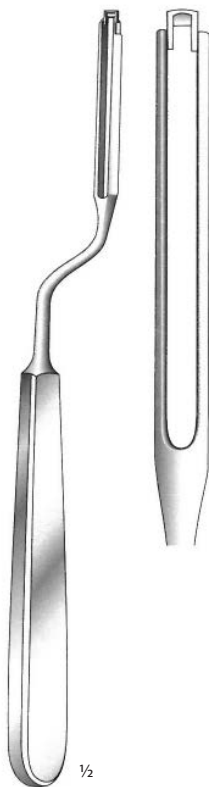

**BALLENGER**  
**112 30 0260**  
20,0 cm



**FREER „D“**  
**112 91 0261**  
15,0 cm



**FREER „E“**  
**112 91 0262**  
15,0 cm

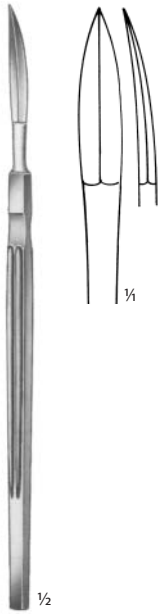

**FREER**  
**112 91 0263**  
15,0 cm

NOŽE NOSNÍ  
NASAL KNIVES

**FOMON**  
**112 91 0255**  
16,0 cm

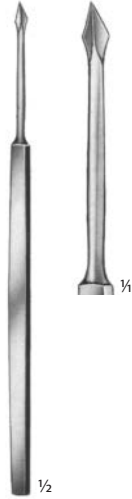

**MASING**  
**112 91 0256**  
13,0 cm

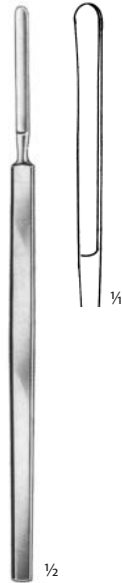

**COTTLE**  
**112 91 0258**  
15,0 cm

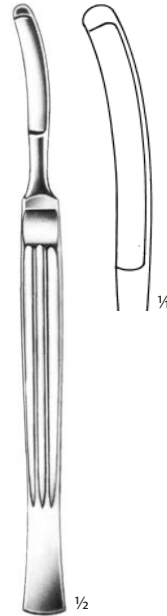

**CONVERSE**  
**112 91 0259**  
16,0 cm



**JOSEPH**  
**112 91 0260**  
15,0 cm



**BRUENINGS**  
**112 91 0264**  
16,0 cm

**112 91 0265**  
náhradní čepelka  
spare blade

NOŽE  
KNIVES

Nůž na flegmonu (absces)  
Phlegmon (abscess) knife  
**112 32 0080**  
18,0 cm

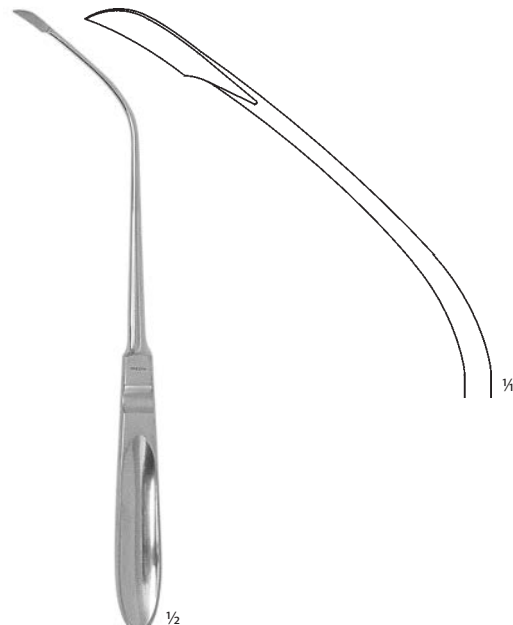

**BAGINSKY**  
Nůž hrtanový  
Laryngeal knife  
**112 33 0020**  
24,5 cm



**LA FORCE**  
25,0 cm



Fig. 1

**112 91 0290**  
neperforovaná čepel  
unperforated blade

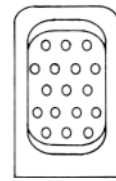

Fig. 4

**112 91 0284**  
perforovaná čepel  
perforated blade

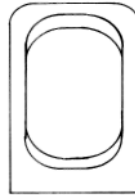

Fig. 2

**112 91 0291**  
neperforovaná čepel  
unperforated blade

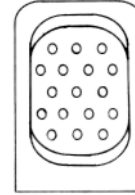

Fig. 5

**112 91 0285**  
perforovaná čepel  
perforated blade

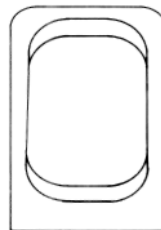

Fig. 3

**112 91 0292**  
neperforovaná čepel  
unperforated blade

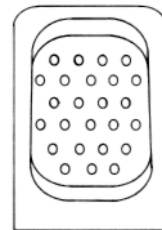

Fig. 6

**112 91 0286**  
perforovaná čepel  
perforated blade

**ČEPELE K ADENOTOMU LA FORCE**  
BLADES FOR ADENOTOM LA FORCE



original Fig. 1

neperforovaná  
unperforated  
**112 91 0293** Fig. 1  
**112 91 0294** Fig. 2  
**112 91 0295** Fig. 3



original Fig. 4

perforovaná  
perforated  
**112 91 0287** Fig. 4  
**112 91 0288** Fig. 5  
**112 91 0289** Fig. 6

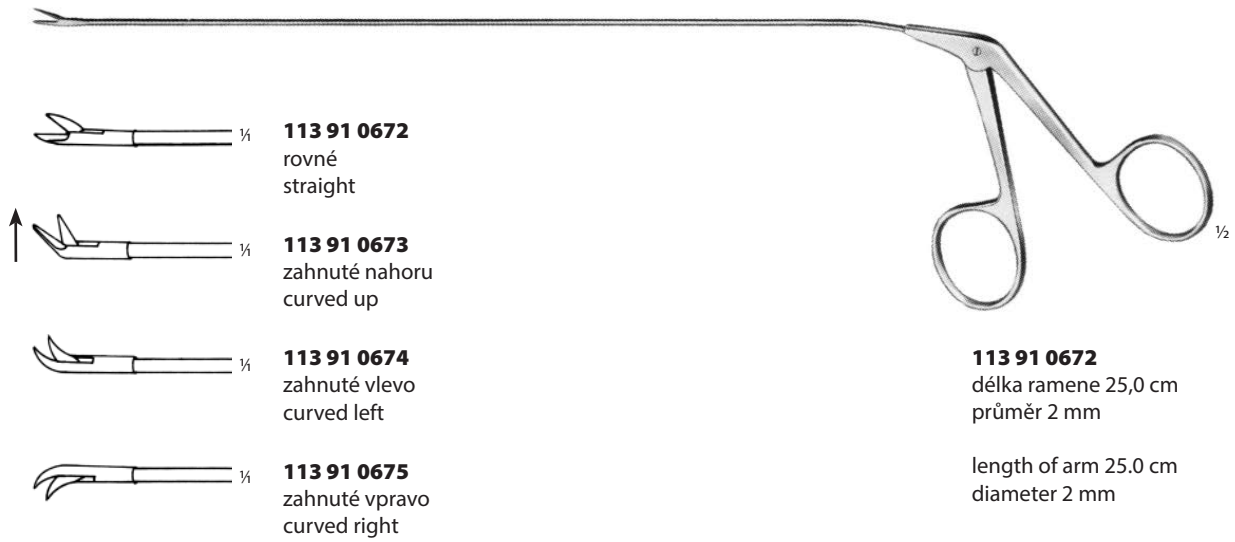
ENDOHRTRANOVÉ MIKRO NŮŽKY  
ENDOLARYNGEAL MICRO SCISSORSNŮŽKY NA SEPTUM  
SEPTUM SCISSORS

**KILLIAN**  
**113 91 0676**  
 20,0 cm

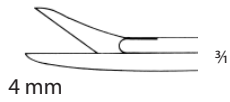

**113 91 0677**  
rovné  
straight

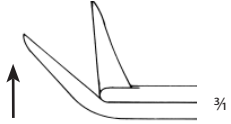

**113 91 0678**  
zahnuté nahoru  
curved up



**113 91 0679**  
zahnuté vlevo  
curved left



**113 91 0680**  
zahnuté vpravo  
curved right



**BELLUCCI**  
délka ramene 8,0 cm  
length of arm 8.0 cm

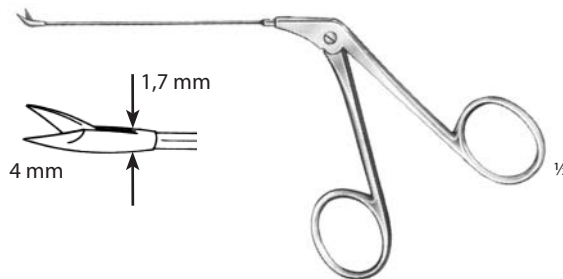

**WULLSTEIN**  
**113 91 0681**  
délka ramene 8,0 cm  
length of arm 8.0 cm

KLEŠTĚ UŠNÍ, KLEŠTĚ NA UŠNÍ POLYPY  
EAR FORCEPS, EAR POLYPUS FORCEPS

délka ramene 8,5 cm  
length of arm 8.5 cm



**HARTMANN**  
**116 91 0242** 2,0 mm  
**116 91 0243** 2,5 mm  
**116 91 0244** 3,0 mm



**HARTMANN**  
**116 91 0245** 2,0 mm  
**116 91 0246** 2,5 mm  
**116 91 0247** 3,0 mm



**STRÜMPEL**  
**116 91 0248**



**HARTMANN**  
**116 91 0249**



**HARTMANN**  
**116 91 0250**



**HARTMANN-HOFFMANN**  
**116 91 0251**



**STRÜMPEL**  
**116 29 0300**  
délka ramene 10,0 cm  
length of arm 10.0 cm  
2,2 × 7 mm

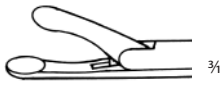

**116 91 0177**  
rovné  
straight

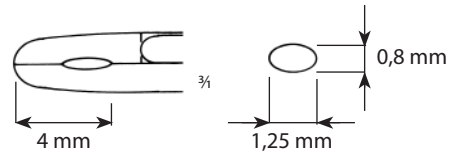

**116 91 0178**  
zahnuté vpravo  
curved right



**116 91 0179**  
zahnuté vlevo  
curved left



délka ramene 8,0 cm  
length of arm 8.0 cm



**116 91 0180**  
zahnuté nahoru  
curved up



**116 91 0181**  
zahnuté dolů  
curved down

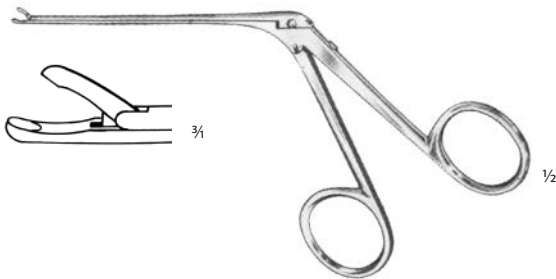

**CRURA-NIPPER**  
**116 91 0182**  
délka ramene 8,0 cm  
length of arm 8.0 cm

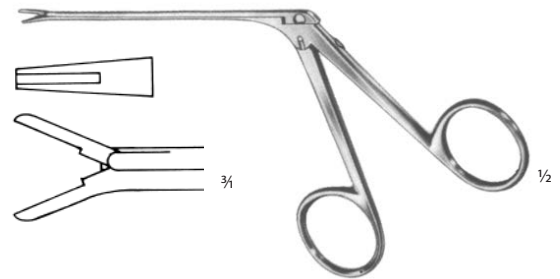

**McGEE**  
**116 91 0183**  
délka ramene 8,0 cm  
length of arm 8.0 cm



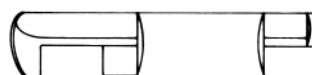

**116 91 0184**



**116 91 0185**

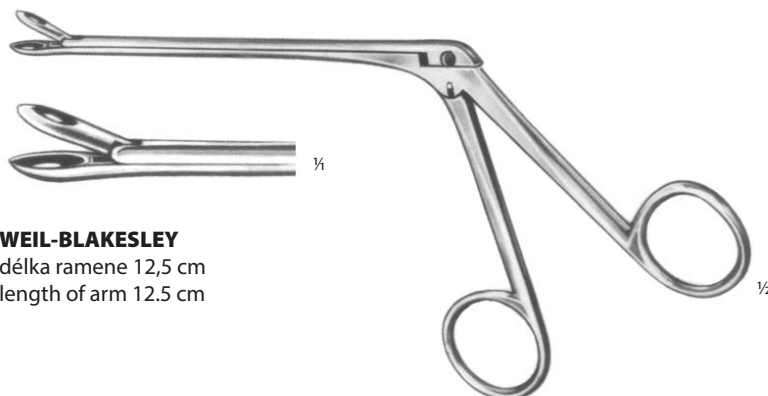

**DIETER**  
délka ramene 8,0 cm  
length of arm 8.0 cm

 ¼ **116 91 0192**
 ¼ **116 91 0193**
 ¼ **116 91 0194**
 ¼ **116 91 0195**
 ¼ **116 91 0196**
 ¼ **116 91 0197**
 ¼ **116 91 0198**
 ¼ **116 91 0199**

**WEIL-BLAKESLEY**  
délka ramene 12,5 cm  
length of arm 12.5 cm



**WEIL-BLAKESLEY**  
délka ramene 12,5 cm  
length of arm 12.5 cm



**WEIL-BLAKESLEY**  
**116 91 0200**  
délka ramene 12,5 cm  
length of arm 12.5 cm



**WEIL-BLAKESLEY**  
**116 91 0201**  
délka ramene 12,5 cm  
length of arm 12.5 cm



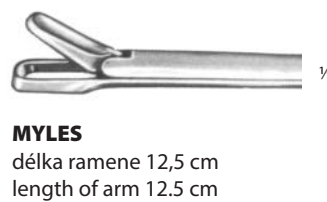
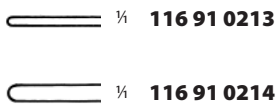
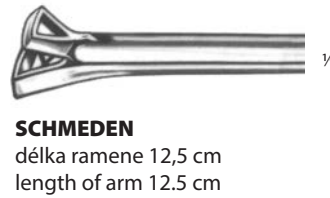
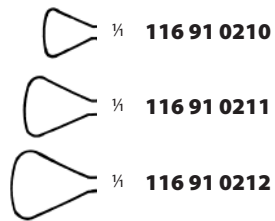
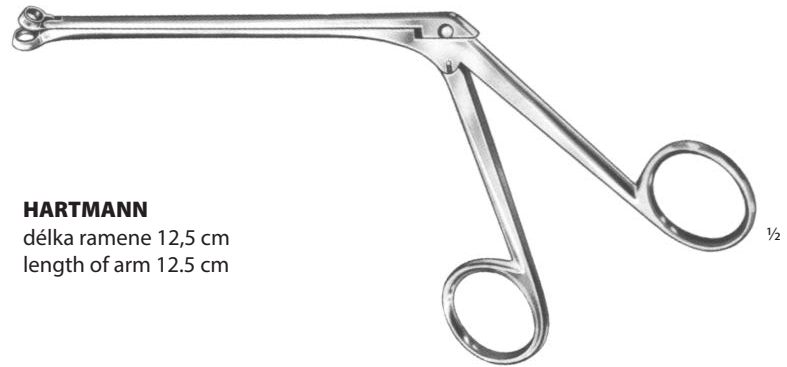
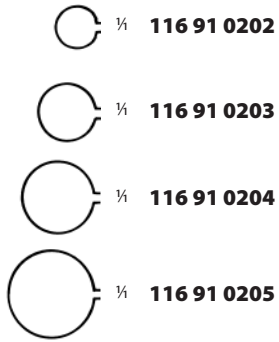



116 91 0219

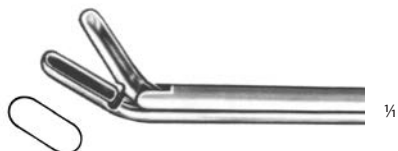

116 91 0220



**TAKAHASHI**

délka ramene 12,5 cm  
length of arm 12.5 cm



116 91 0221



116 91 0222

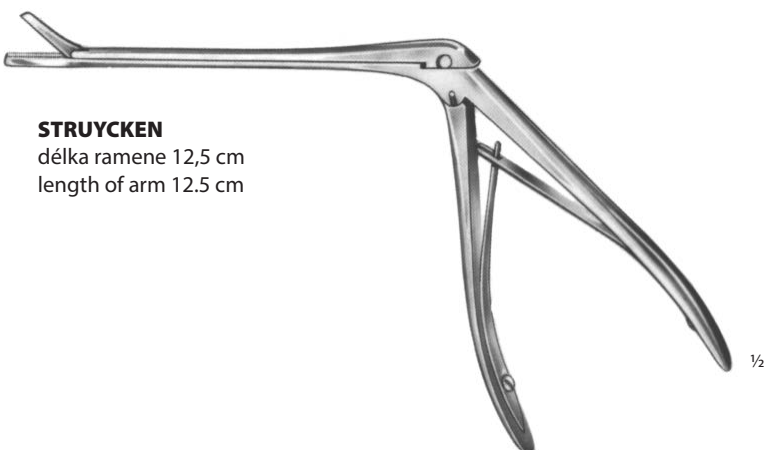

**STRUYCKEN**

délka ramene 12,5 cm  
length of arm 12.5 cm



**JANSSEN-MIDDLETON**

116 91 0223

19,0 cm

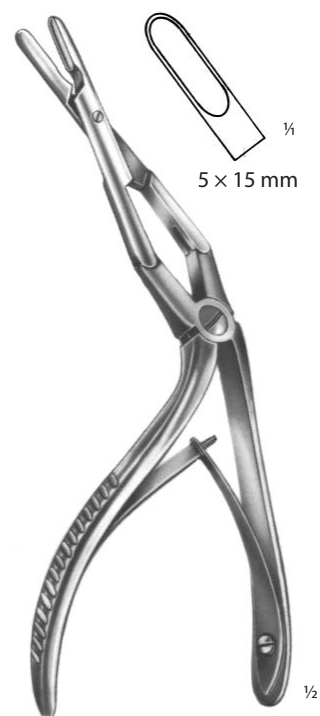

**JANSSEN-MIDDLETON**

116 91 0224

19,0 cm



**CRAIG**  
**116 91 0225**  
17,0 cm



**CRAIG-DOMNICK**  
17,0 cm

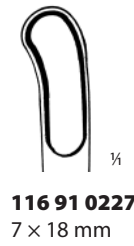

**116 91 0227**  
7 × 18 mm



**BRUENINGS**  
19,0 cm

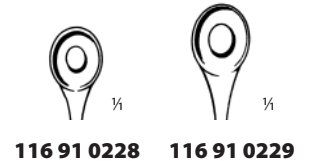

**116 91 0228** **116 91 0229**

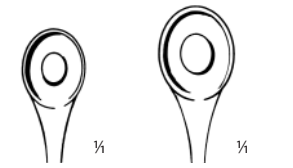

**116 91 0230** **116 91 0231**

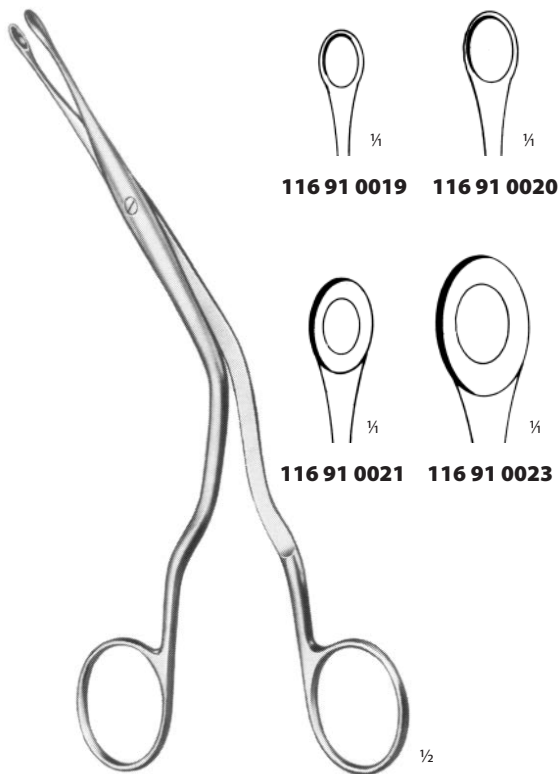

**LUC**  
20,0 cm

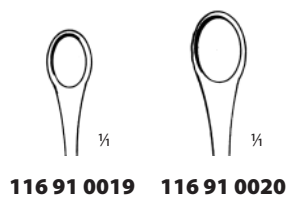

**116 91 0019** **116 91 0020**

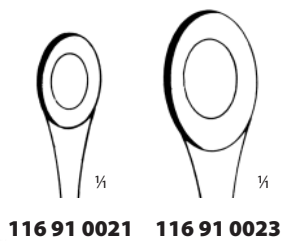

**116 91 0021** **116 91 0023**

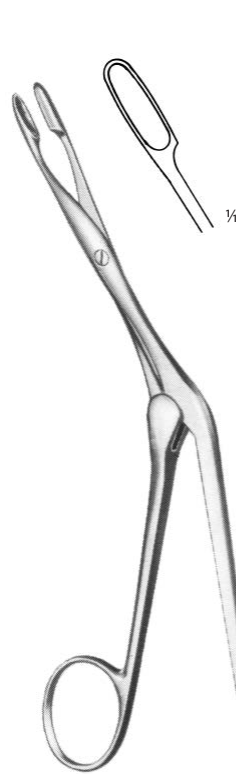

**KNIGHT**  
**116 91 0232**  
18,0 cm

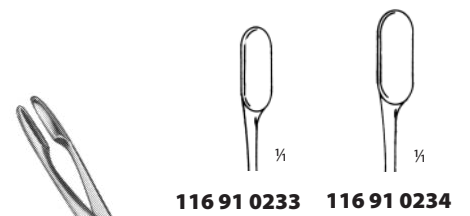

**116 91 0233** **116 91 0234**

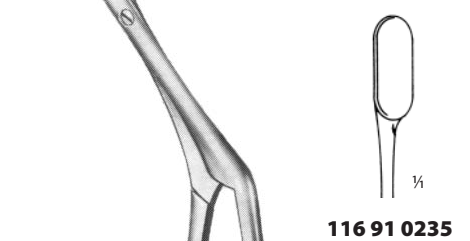

**116 91 0235**

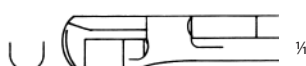
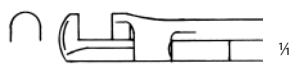
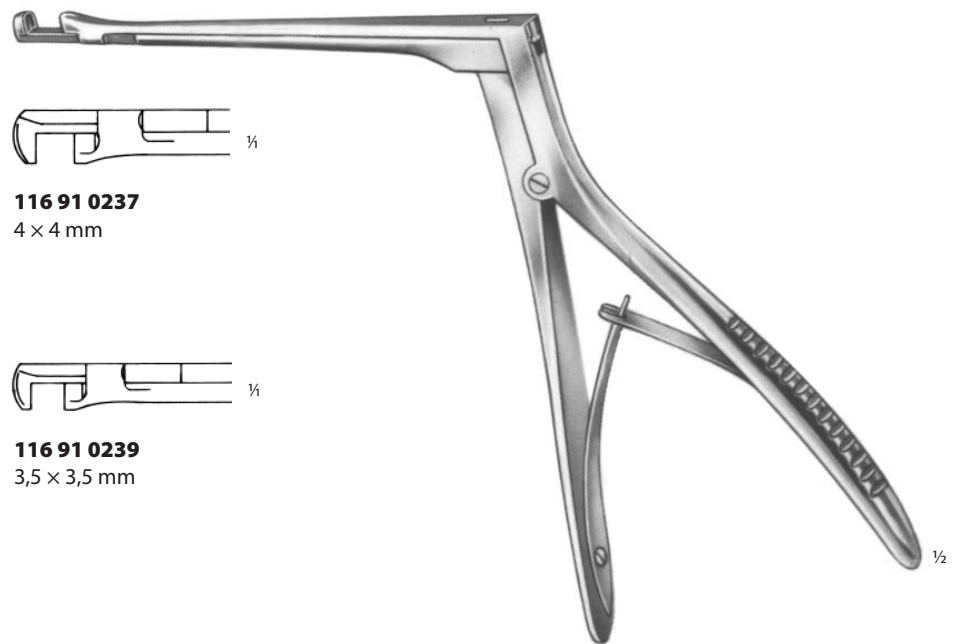

**HEYMANN**  
18,0 cm

KLEŠTĚ UŠNÍ ŠTÍPACÍ  
MASTOID FORCEPS**JANSEN**  
18,0 cm**116 29 0400**  
rovné  
straight  
Fig. 1**116 29 0410**  
zahnuté  
curved  
Fig. 2ŠTÍPÁKY SFENOIDÁLNÍ  
SPHENOID PUNCHES**116 91 0236**  
4 x 4 mm**116 91 0237**  
4 x 4 mm**116 91 0238**  
3,5 x 3,5 mm**116 91 0239**  
3,5 x 3,5 mm**HAJEK-KOFFLER**  
délka ramene 14,0 cm  
length of arm 14.0 cm

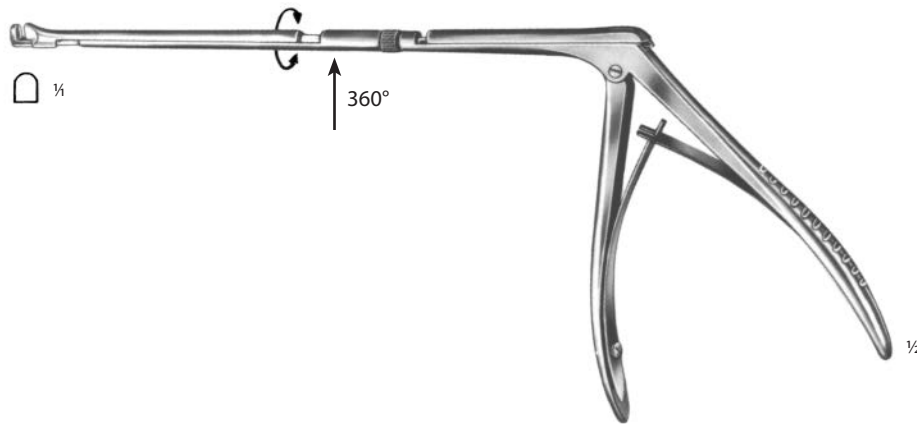

**KERRISON**  
**116 91 0240**  
délka ramene 14,0 cm  
length of arm 14.0 cm

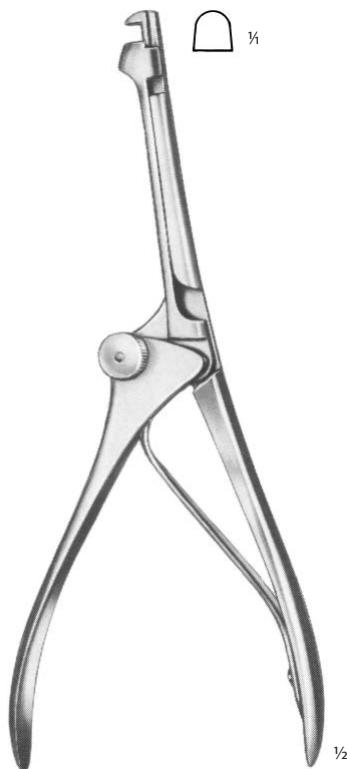

**HAJEK-CLAUS**  
**116 91 0241**  
délka ramene 20,0 cm  
length of arm 20.0 cm



**116 91 0252**  
3 x 3 mm



**116 91 0253**  
4 x 4 mm



**116 91 0254**  
5 x 5 mm



**116 91 0255**  
6 x 6 mm

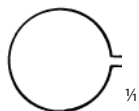
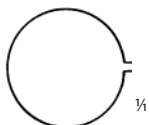
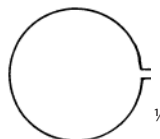

**KERRISON**  
délka ramene 9,0 cm  
length of arm 9.0 cm

**116 91 0056**Fig. 1  
Ø 13 mm**116 91 0057**Fig. 2  
Ø 15 mm**116 91 0058**Fig. 3  
Ø 17 mm**HARTMANN**délka ramene 13,0 cm  
length of arm 13.0 cm

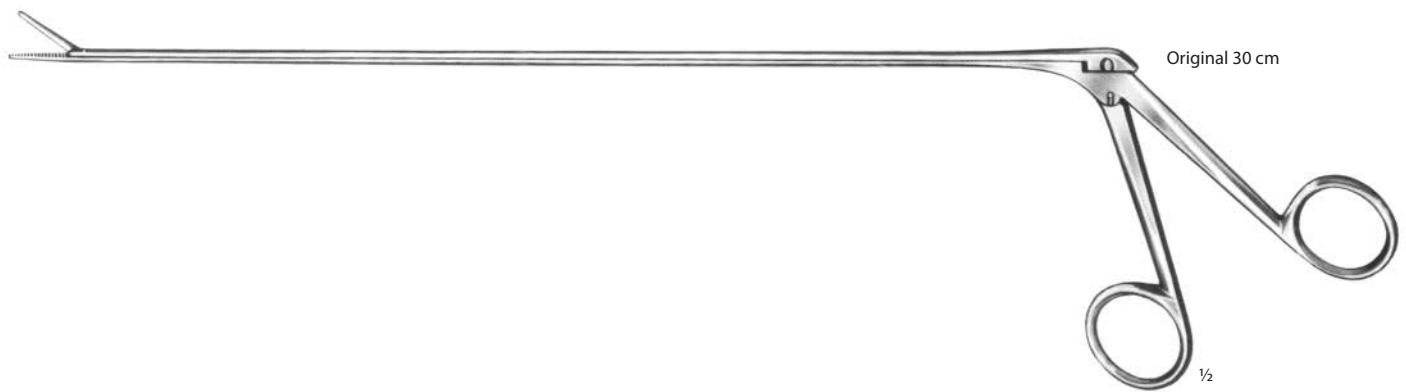

CHEVALIER-JACKSON

délka ramene  
length of arm  
30,0 cm  
40,0 cm  
50,0 cm  
60,0 cm



Fig. 1  
**116 91 0062**  
**116 91 0063**  
**116 91 0064**  
**116 91 0065**



Fig. 2  
**116 91 0066**  
**116 91 0067**  
**116 91 0068**  
**116 91 0069**



Fig. 3  
**116 91 0070**  
**116 91 0071**  
**116 91 0072**  
**116 91 0073**



Fig. 4  
**116 91 0074**  
**116 91 0075**  
**116 91 0076**  
**116 91 0077**

délka ramene  
length of arm  
30,0 cm  
40,0 cm  
50,0 cm  
60,0 cm



Fig. 5  
**116 91 0078**  
**116 91 0079**  
**116 91 0080**  
**116 91 0081**



Fig. 6  
**116 91 0082**  
**116 91 0083**  
**116 91 0084**  
**116 91 0085**



Fig. 7  
**116 91 0086**  
**116 91 0087**  
**116 91 0088**  
**116 91 0089**



Fig. 8  
**116 91 0090**  
**116 91 0091**  
**116 91 0092**  
**116 91 0093**

délka ramene  
length of arm  
30,0 cm  
40,0 cm  
50,0 cm  
60,0 cm

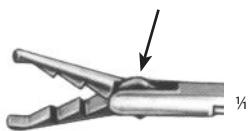

Fig. 9  
**116 91 0094**  
**116 91 0095**  
**116 91 0096**  
**116 91 0097**

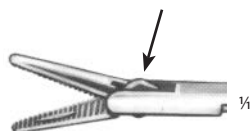

Fig. 10  
**116 91 0098**  
**116 91 0099**  
**116 91 0100**  
**116 91 0101**

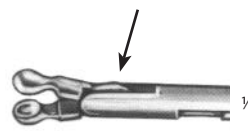

Fig. 11  
**116 91 0102**  
**116 91 0103**  
**116 91 0104**  
**116 91 0105**



**HUBER**  
**116 91 0106**



Original 30 cm

**BRUENINGS**  
**116 91 0107** 20,0 cm  
**116 91 0108** 30,0 cm  
**116 91 0109** 40,0 cm  
**116 91 0110** 50,0 cm  
**116 91 0111** 60,0 cm



**BRUENINGS**  
**116 91 0112**  
pevná  
rigid  
20,0 cm

**116 91 0113**  
ohěbná  
malleable  
20,0 cm



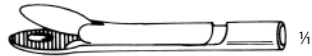

**FRAENKEL**  
116 91 0114



**SEIFFERT**  
116 91 0115

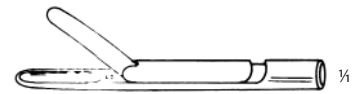

**FRAENKEL**  
116 91 0116

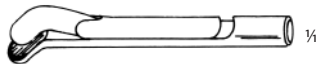

**SCHEINMANN**  
116 91 0117



**SCHEINMANN**  
116 91 0118

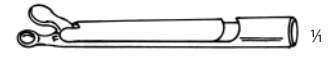

- BRUENINGS**
- 116 91 0119 2 mm
  - 116 91 0120 3 mm
  - 116 91 0121 4 mm

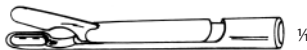

- BRUENINGS**
- 116 91 0122
  - 116 91 0123

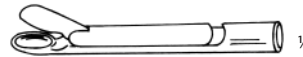

**LANGE**  
116 91 0124



- KRAUSE**
- ⊕ 116 91 0125 2,5 mm
  - ⊕ 116 91 0126 3,5 mm

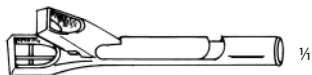

**KRAUSE**  
116 91 0127

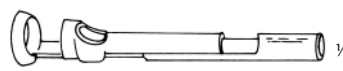

- CORDES**
- ⊕ 116 91 0128 Fig. 1
  - ⊕ 116 91 0129 Fig. 2
  - ⊕ 116 91 0130 Fig. 3
  - ⊕ 116 91 0131 Fig. 4

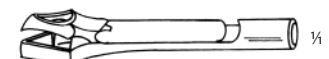

**SCHUMACHER**  
116 91 0132



- CORDES**
- ⊕ 116 91 0133 Fig. 1
  - ⊕ 116 91 0134 Fig. 2

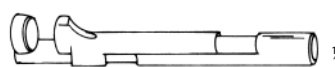

**CORDES**  
116 91 0135







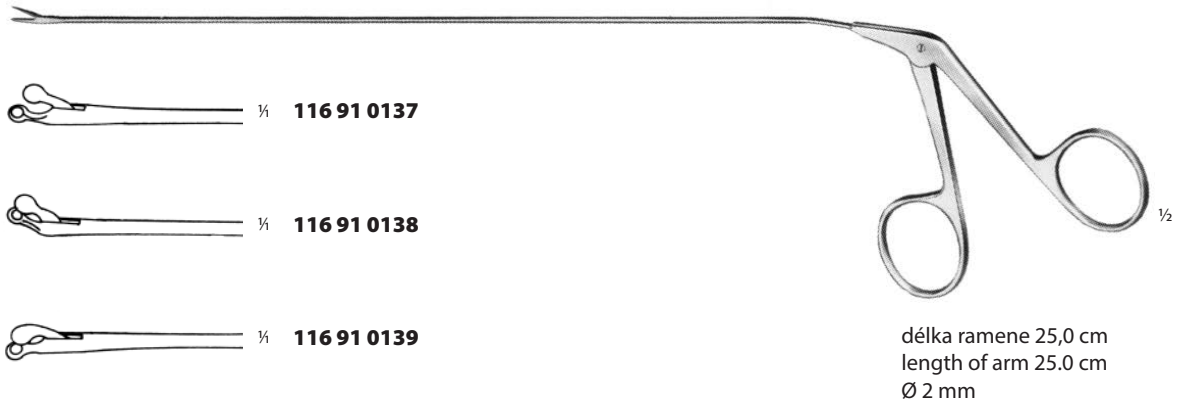

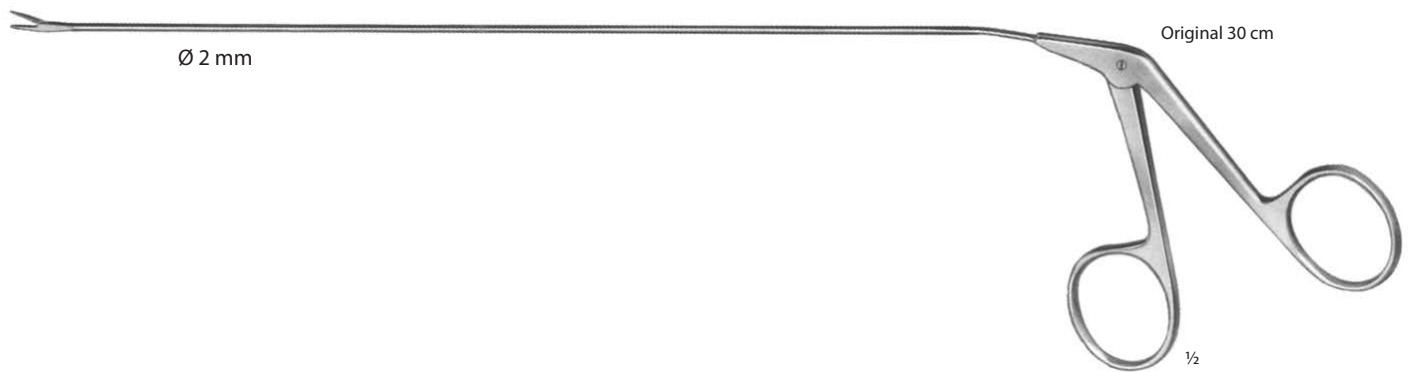

**ROSENBERG**  
116 91 0136

**ENDOHRTRANOVÉ MIKRO KLEŠTĚ**  
ENDOLARYNGEAL MICRO FORCEPS



**KLEŠTĚ NA BRONCHOSKOPII**  
FORCEPS FOR LARYNGO-BRONCHOSCOPY



délka ramene length of arm 30,0 cm 35,0 cm	 1/4 <b>116 91 0143</b> <b>116 91 0144</b>	 1/4 <b>116 91 0150</b> <b>116 91 0151</b>	 1/4 <b>116 91 0157</b> <b>116 91 0158</b>	 1/4 <b>116 91 0164</b> <b>116 91 0165</b>
délka ramene length of arm 40,0 cm 45,0 cm 50,0 cm 55,0 cm 60,0 cm	 1/4 <b>116 91 0145</b> <b>116 91 0146</b> <b>116 91 0147</b> <b>116 91 0148</b> <b>116 91 0149</b>	 1/4 <b>116 91 0152</b> <b>116 91 0153</b> <b>116 91 0154</b> <b>116 91 0155</b> <b>116 91 0156</b>	 1/4 <b>116 91 0159</b> <b>116 91 0160</b> <b>116 91 0161</b> <b>116 91 0162</b> <b>116 91 0163</b>	 1/4 <b>116 91 0166</b> <b>116 91 0167</b> <b>116 91 0168</b> <b>116 91 0169</b> <b>116 91 0170</b>

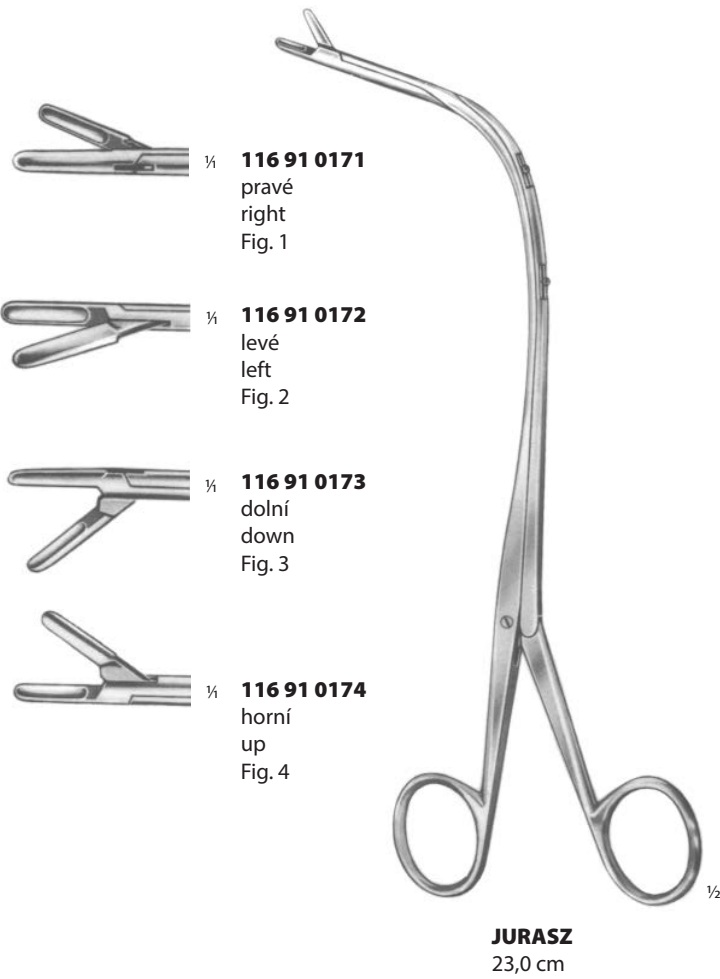

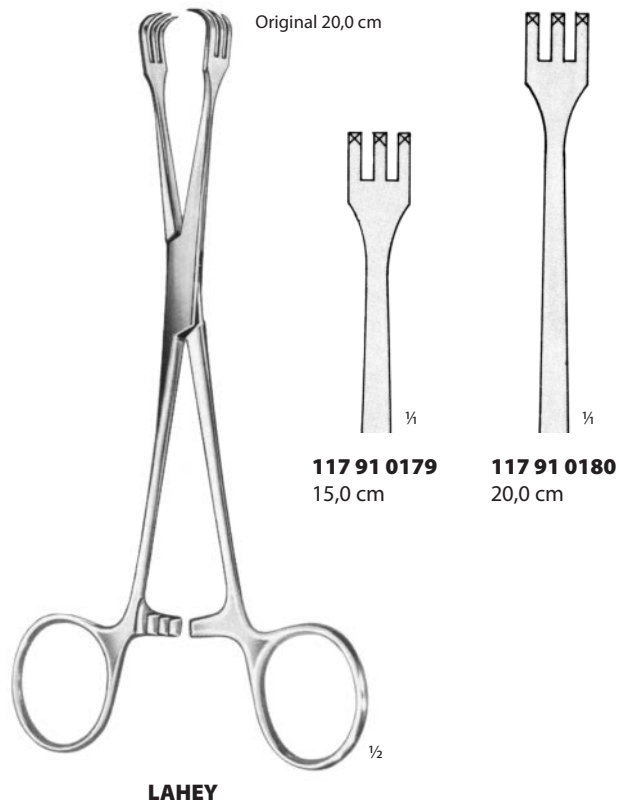
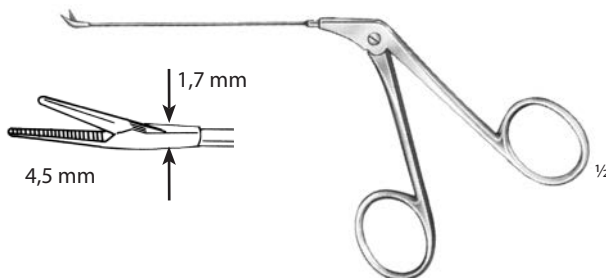
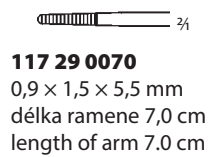
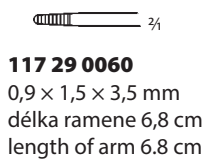
KLEŠTĚ ÚCHOPNÉ  
SEIZING FORCEPSKLEŠTĚ UŠNÍ ÚCHOPNÉ  
EAR FORCEPS

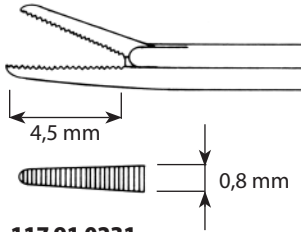

117 91 0231

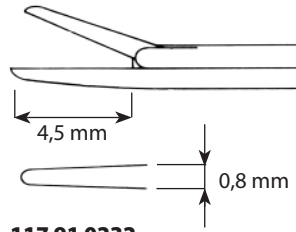

117 91 0232



délka ramene 8,0 cm  
length of arm 8.0 cm

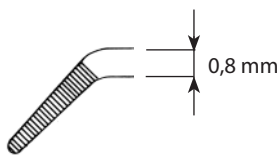

117 91 0233

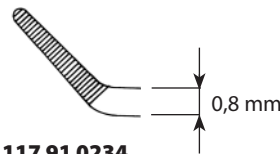

117 91 0234

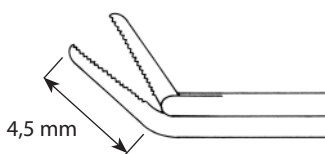

117 91 0235

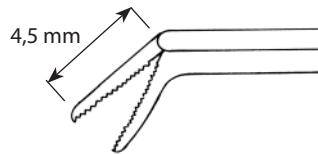

117 91 0236

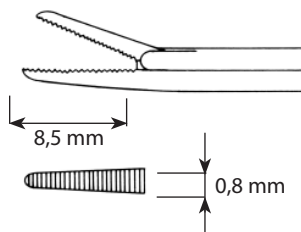

117 91 0237

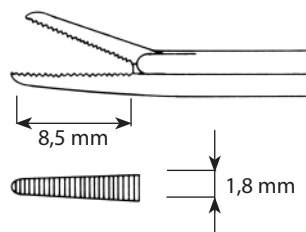

117 91 0238

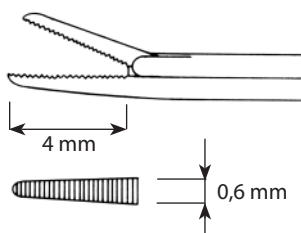

117 91 0239

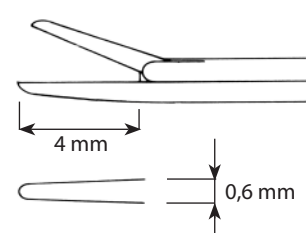

117 91 0240

KLEŠTĚ UŠNÍ, KLEŠTĚ NA POLYPTY  
EAR FORCEPS

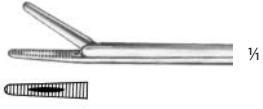

**HARTMANN-NOYES**  
117 91 0190



**DUCKBILL**  
117 91 0191

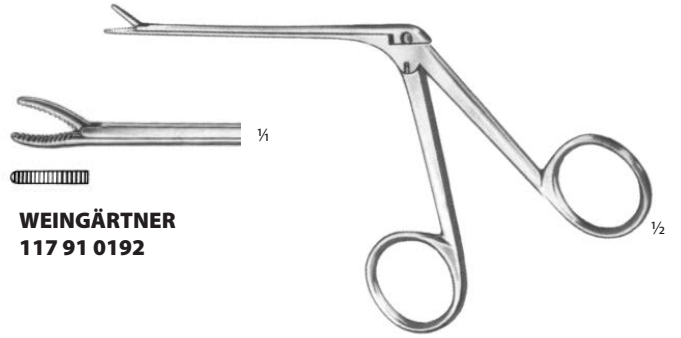

**WEINGÄRTNER**  
117 91 0192

délka ramene 8,5 cm  
length of arm 8.5 cm



**HARTMANN-WULLSTEIN**  
117 91 0184  
délka ramene 8,5 cm  
length of arm 8.5 cm



**HARTMANN**  
117 91 0186  
délka ramene 8,5 cm  
length of arm 8.5 cm

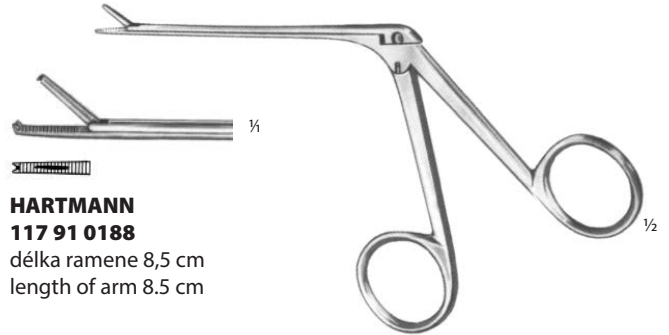

**HARTMANN**  
117 91 0188  
délka ramene 8,5 cm  
length of arm 8.5 cm



**HARTMANN-WULLSTEIN**  
117 91 0185  
délka ramene 8,5 cm  
length of arm 8.5 cm



**HARTMANN**  
117 91 0187  
délka ramene 14,0 cm  
length of arm 14.0 cm

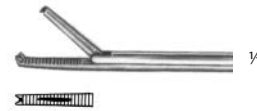

**HARTMANN**  
117 91 0189  
délka ramene 14,0 cm  
length of arm 14.0 cm



**HARTMANN**  
116 29 0010  
14,0 cm



**HARTMANN**  
116 29 0030  
14,0 cm



**HARTMANN**  
**117 91 0215**   **117 91 0216**  
16,0 cm   20,0 cm



**HEYMANN-KNIGHT**  
**117 91 0217**  
18,0 cm

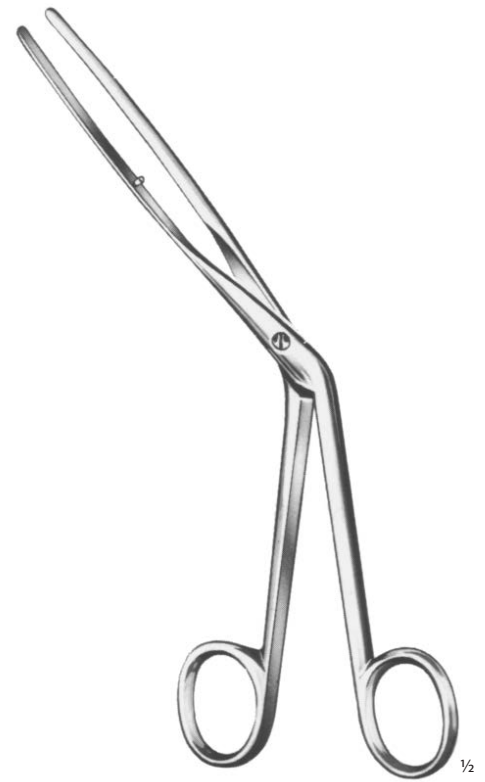

**LUBET-BARBON**  
**117 91 0218**  
20,0 cm



**KILLIAN**  
**117 91 0219**  
17,0 cm

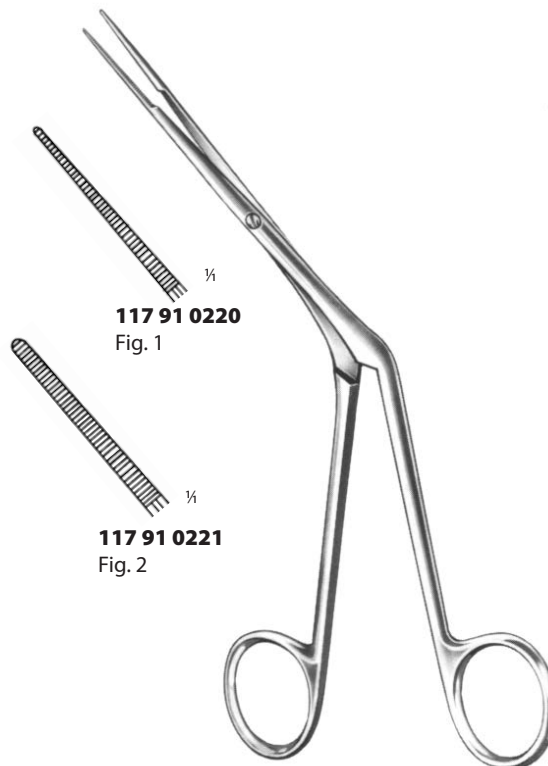

**WESTMACOTT**  
20,0 cm

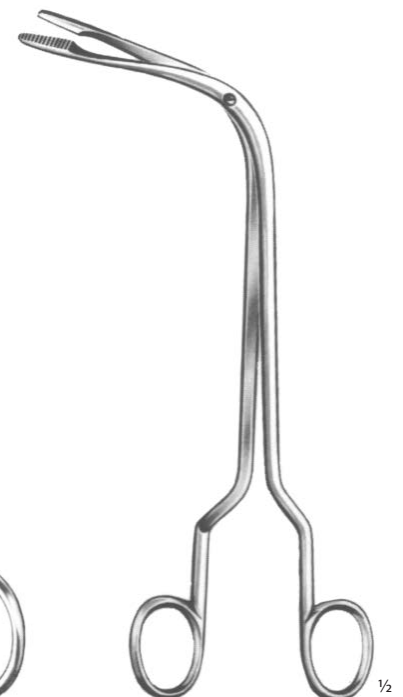

**FRAENKEL**  
**117 91 0181**  
18,0 cm

KLEŠTĚ NA PŘEPÁŽKY, DRTIČ CHRUPAVKY  
SEPTUM FORCEPS, CARTILAGE CRUCHER

**ASCH**  
**117 91 0222**  
23,0 cm

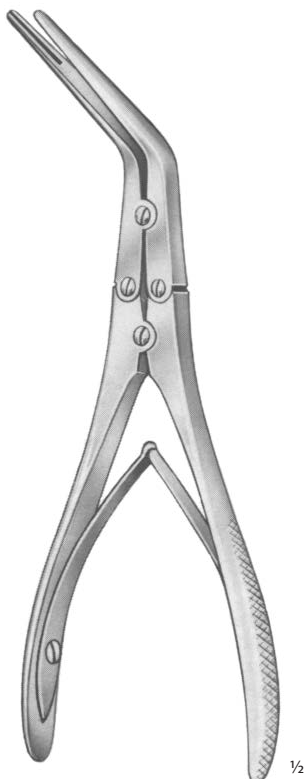

**KRESSNER**  
20,0 cm



**117 91 0228**  
2,5 × 60 mm

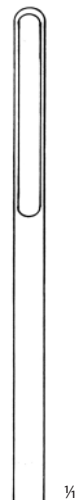

**117 91 0229**  
4 × 70 mm

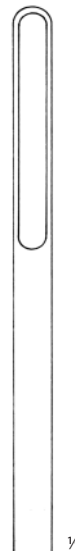

**117 91 0230**  
5 × 75 mm

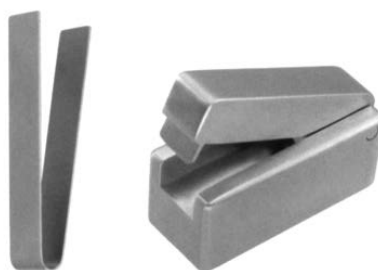

**COTTLE**  
**437-648-000**



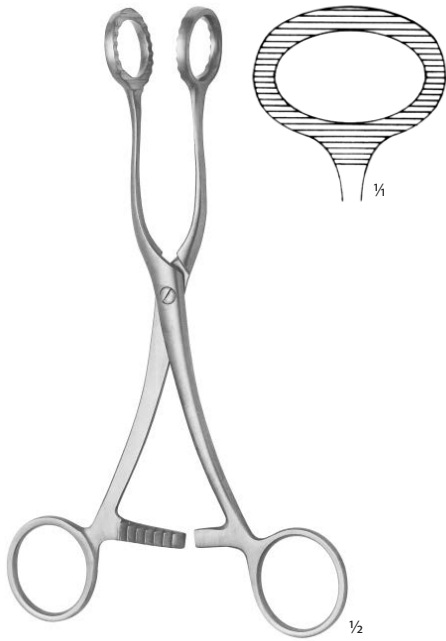

**COLLIN**  
**117 31 0010**  
16,0 cm

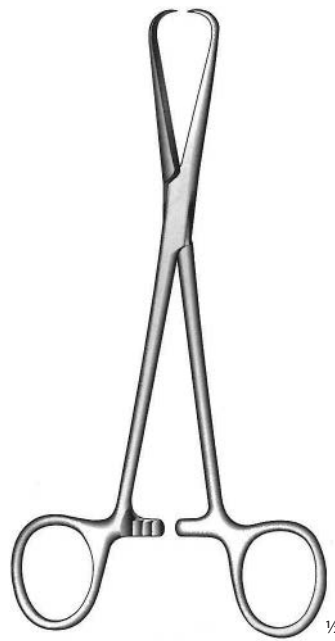

**LÖBKER**  
**117 31 0030**  
16,5 cm



**117 91 0178**  
pár  
pair

**YOUNG**  
**117 91 0177**  
17,0 cm

**ENDOLARYNGEÁLNÍ MIKRO KLEŠTĚ**  
ENDOLARYNGEAL MICRO FORCEPS

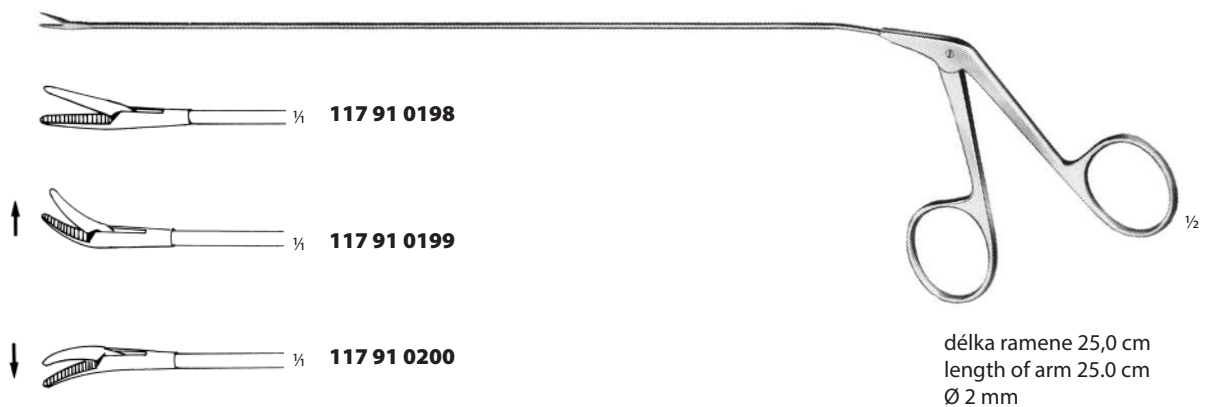

délka ramene 25,0 cm  
length of arm 25.0 cm  
Ø 2 mm

HÁČKY UŠNÍ  
EAR HOOKLETS

**HARTMANN**  
**118 29 0010**  
16,0 cm



**SCHWARTZE**  
**118 29 0060**  
17,0 cm



**HARTMANN**  
**118 91 0419**  
16,5 cm

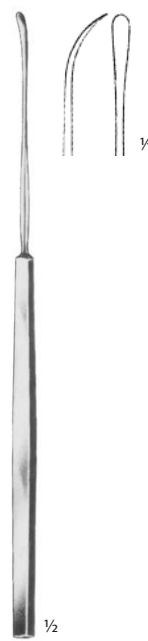

**ZAUFAL**  
**118 91 0420**  
16,5 cm



**WAGENER**  
14,0 cm



**118 91 0421**  
Fig. 1

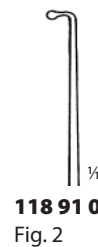

**118 91 0422**  
Fig. 2

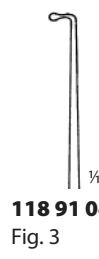

**118 91 0423**  
Fig. 3



**118 91 0424**  
Fig. 4

HÁKY NOSNÍ, HÁKY RESEKČNÍ  
RHINOPLASTIC INSTRUMENTS, RESECTION HOOKS

**AUFRICHT (WALTER)**  
**118 91 0348**  
13,5 cm



**AUFRICHT**  
**118 91 0349**  
19,0 cm

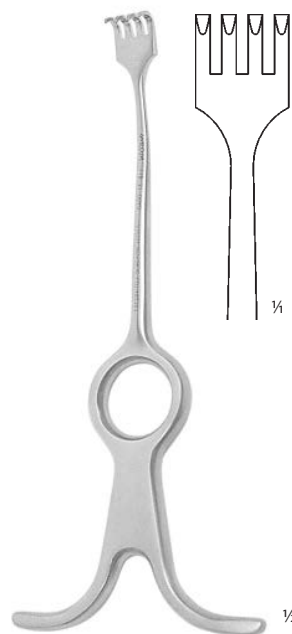

Hák resekční  
Resection hook  
**118 31 0040**  
16,4 cm



Háček na křídlo nosní  
Nasal alar hook  
**118 12 0090**  
10,5 cm



**FOMON**  
**118 91 0335**  
16,0 cm



**FREER**  
**118 91 0336**  
15,0 cm

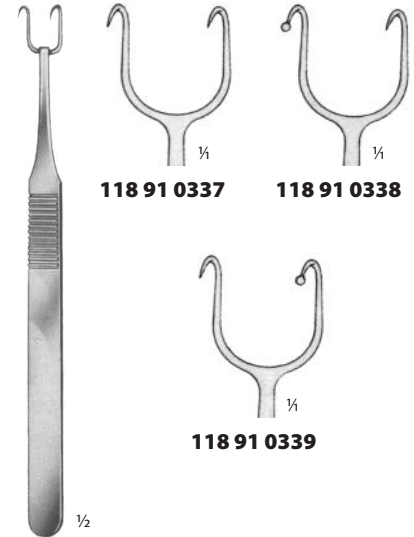

**COTTLE**  
14,0 cm



**COTTLE-NEIVERT**  
**118 91 0343**  
20,0 cm



**COTTLE**  
**118 91 0346**  
15,0 cm



**COTTLE**  
**118 91 0347**  
15,0 cm

HÁKY TRACHEÁLNÍ  
TRACHEAL HOOKS

Hák tracheální  
Tracheal hook  
**118 34 0020**  
23,5 cm



Hák tracheální  
Tracheal hook  
**118 34 0030**  
21,0 cm



**LUKENS**  
**118 91 0323**  
17,0 cm



**ITERSON**  
16,0 cm



**118 91 0320**  
ostrý  
sharp  
Fig. 1



**118 91 0321**  
tupý  
blunt  
Fig. 2

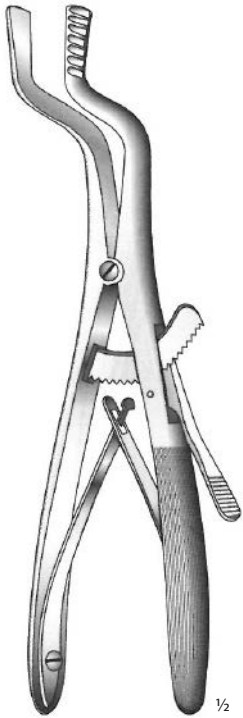

**ROSER-KÖNIG**  
**119 07 0010**  
19,0 cm



**DENHART**  
**119 91 0199**  
12,0 cm

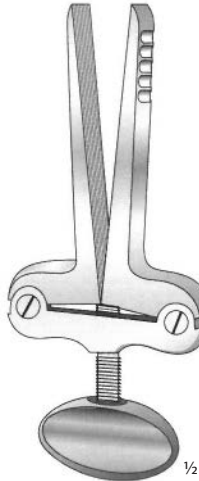

**HEISTER**  
**119 07 0020**  
13,0 cm



**MOLT**  
**119 91 0197**  
dětský  
for children  
11,0 cm



**MOLT**  
**119 91 0198**  
14,0 cm

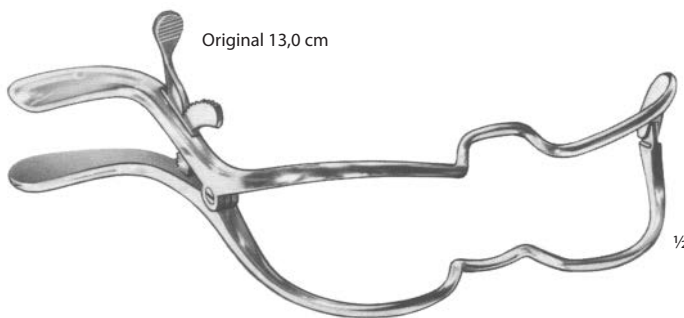

**JENNINGS**  
**119 91 0185** 9,0 cm  
**119 91 0186** 11,0 cm  
**119 91 0187** 13,0 cm  
**119 91 0188** 15,0 cm

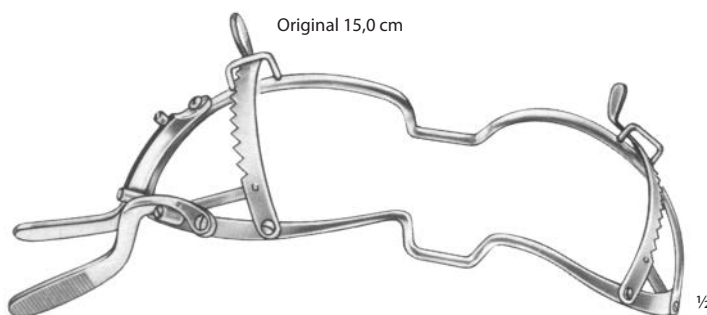

**WHITEHEAD**  
**119 91 0190** 11,0 cm  
**119 91 0191** 13,0 cm  
**119 91 0192** 15,0 cm

ROZVĚRAČE ÚST  
MOUTH RETRACTORS

**MC IVOR**  
**119 91 0222**  
komplet  
complete

**119 91 0226**  
rám  
gag only



**119 91 0223**  
95 × 27 mm  
Fig. 1



**119 91 0224**  
85 × 22 mm  
Fig. 3

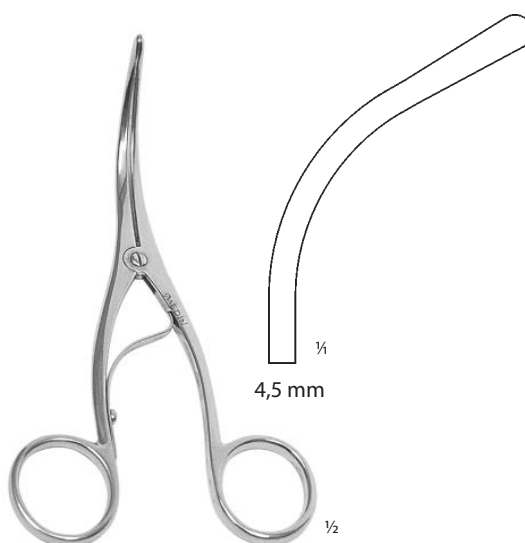

**119 91 0225**  
70 × 22 mm  
Fig. 3

ROZVĚRAČ TRACHEY  
TRACHEAL RETRACTOR

**TROUSSEAU**  
**135 34 0010**  
13,5 cm



**SIMPLEX**  
**121 91 0013**  
11,0 cm



**TOBOLD**  
**121 91 0014**  
14,5 cm



**MORITZ-SCHMIDT**  
**121 91 0016**  
19,0 cm



**WIEDER**  
14,5 cm

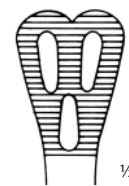

**121 91 0017**  
28 mm

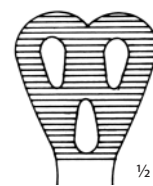

**121 91 0018**  
32 mm



½

**BUCHWALD**  
**121 31 0010**  
17,3 cm  
16/23 mm



½

**STANDARD**  
**121 91 0020**  
14,5 cm



½

**KROENIG**  
**121 91 0022**  
15,0 cm



½

**BRUENINGS**  
**121 31 0020**  
19,5 cm  
14/18 mm



½

**BRUENINGS**  
**121 91 0024**  
19,0 cm



½

**MAYO**  
**121 91 0023**  
17,0 cm



½

**121 91 0026**  
18,0 cm





**HARTMANN**  
**122 91 0205** Fig. 0-2  
sada  
set

- 122 91 0206** Fig. 0 2,0 mm
- 122 91 0207** Fig. 1 3,5 mm
- 122 91 0208** Fig. 2 5,0 mm



**HARTMANN**  
**122 91 0212** Fig. 1-4  
sada  
set

- 122 91 0207** Fig. 1 3,5 mm
- 122 91 0208** Fig. 2 5,0 mm
- 122 91 0209** Fig. 3 6,5 mm
- 122 91 0210** Fig. 4 7,5 mm

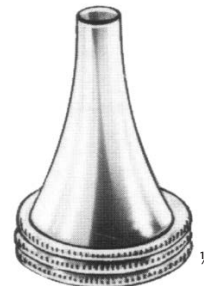

**POLITZER**  
**122 91 0200** Fig. 1-3  
sada  
set

- 122 91 0201** Fig. 1 2,0 mm
- 122 91 0202** Fig. 2 3,0 mm
- 122 91 0203** Fig. 3 4,0 mm
- 122 91 0204** Fig. 4 5,0 mm



**TOYNBEE**  
**122 91 0219** Fig. 1-4  
sada  
set

- 122 91 0220** Fig. 1 3,0 mm
- 122 91 0221** Fig. 2 4,0 mm
- 122 91 0222** Fig. 3 5,5 mm
- 122 91 0223** Fig. 4 6,5 mm

**HARTMANN**  
**122 91 0211** Fig. 2-4  
sada  
set

- 122 91 0208** Fig. 2 5,0 mm
- 122 91 0209** Fig. 3 6,5 mm
- 122 91 0210** Fig. 4 7,5 mm

**TOYNBEE**  
**122 91 0218** Fig. 2-4  
sada  
set

- 122 91 0221** Fig. 2 4,0 mm
- 122 91 0222** Fig. 3 5,5 mm
- 122 91 0223** Fig. 4 6,5 mm



**HARTMANN**  
**122 91 0217** Fig. 0-3  
sada  
set

- 122 91 0213** Fig. 0 3,0 mm
- 122 91 0214** Fig. 1 4,0 mm
- 122 91 0215** Fig. 2 5,0 mm
- 122 91 0216** Fig. 3 7,0 mm









○ <b>FARRIOR</b> <b>122 91 0241</b> 3,3 mm	○ 3,0 × 4,0 mm	<b>FARRIOR</b> <b>122 91 0250</b>	<b>FARRIOR</b> <b>122 91 0259</b>	<b>FARRIOR</b> <b>122 91 0268</b>
○ <b>122 91 0242</b> 4,3 mm	○ 4,0 × 5,0 mm	<b>122 91 0251</b>	<b>122 91 0260</b>	<b>122 91 0269</b>
○ <b>122 91 0243</b> 4,8 mm	○ 4,5 × 5,5 mm	<b>122 91 0252</b>	<b>122 91 0261</b>	<b>122 91 0270</b>
○ <b>122 91 0244</b> 5,3 mm	○ 5,0 × 6,0 mm	<b>122 91 0253</b>	<b>122 91 0262</b>	<b>122 91 0271</b>
○ <b>122 91 0245</b> 5,8 mm	○ 5,5 × 6,5 mm	<b>122 91 0254</b>	<b>122 91 0263</b>	<b>122 91 0272</b>
○ <b>122 91 0246</b> 6,3 mm	○ 6,0 × 7,0 mm	<b>122 91 0255</b>	<b>122 91 0264</b>	<b>122 91 0273</b>
○ <b>122 91 0247</b> 6,7 mm	○ 6,5 × 7,5 mm	<b>122 91 0256</b>	<b>122 91 0265</b>	<b>122 91 0274</b>
○ <b>122 91 0248</b> 7,2 mm	○ 7,0 × 8,0 mm	<b>122 91 0257</b>	<b>122 91 0266</b>	<b>122 91 0275</b>
○ <b>122 91 0249</b> 7,7 mm	○ 7,5 × 8,5 mm	<b>122 91 0258</b>	<b>122 91 0267</b>	<b>122 91 0276</b>



**BRUENINGS**

**122 91 0277**

komplet 4 zrcátka Fig. 0-3  
complete with 4 specula Fig. 0-3

-  **122 91 0278** Fig.00 2/4 mm
-  **122 91 0279** Fig.0 3/4,8 mm
-  **122 91 0280** Fig.1 4/6 mm
-  **122 91 0281** Fig.2 5/7 mm
-  **122 91 0282** Fig.3 6,5/8,5 mm
-  **122 91 0283** Fig.4 8,5/10,5 mm
-  **122 91 0284** Fig.5 10,5/12,5 mm

**122 91 0285**

hlava sací se zvětšováním  
suction head, only

**122 91 0286**

balónek s trubičkou  
rubertube and bulb, only



**SIEGLE**

**122 91 0288**

komplet – complete



**122 91 0292**

balónek s trubičkou  
rubertube and bulb, only



**KILLIAN**  
13,0 cm

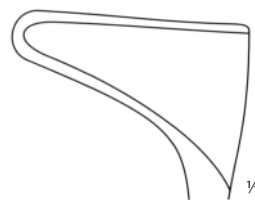

**46-041-001**  
35 mm

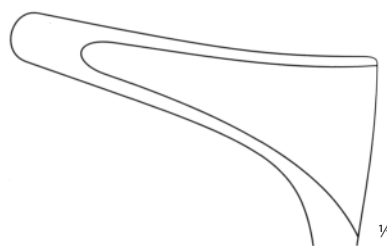

**46-041-002**  
50 mm

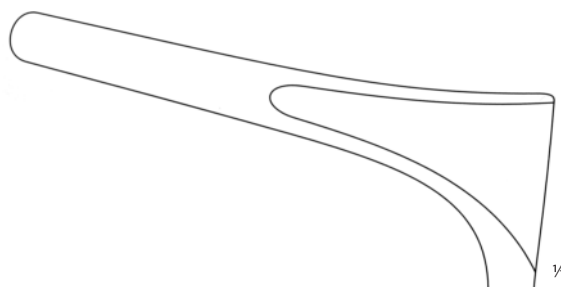

**46-041-003**  
75 mm

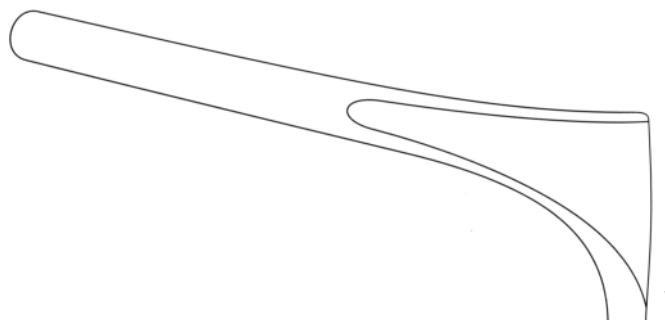

**46-041-004**  
90 mm

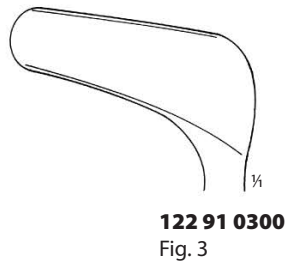
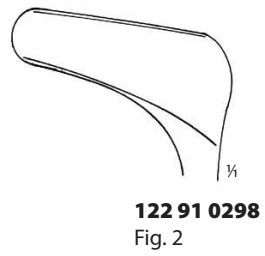
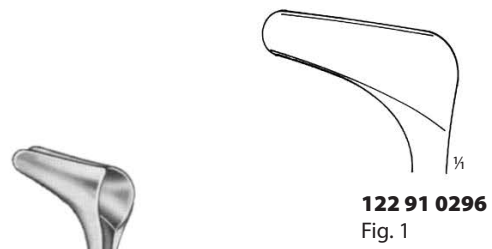

**HARTMANN-HALLE**  
15,0 cm

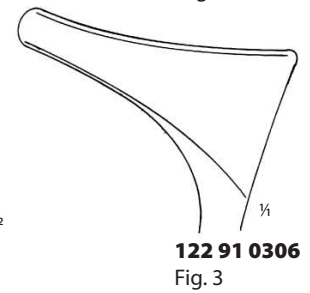
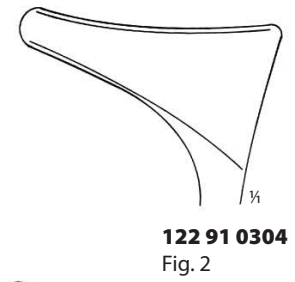
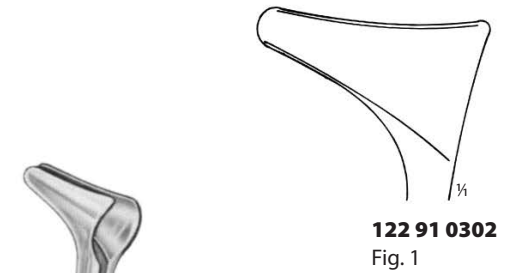

**HARTMANN**  
15,0 cm

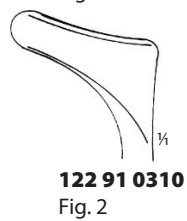
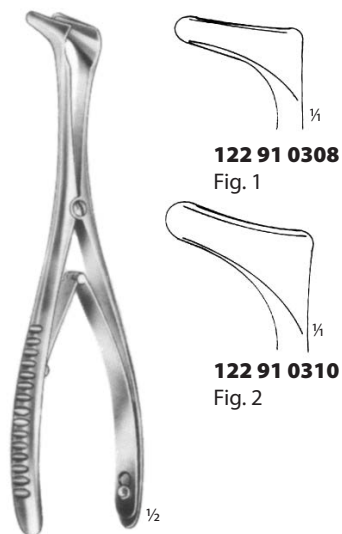

**TIECK-HALLE**  
13,5 cm

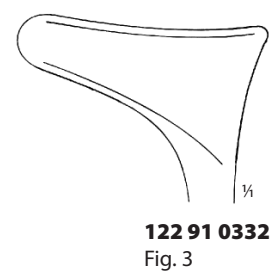
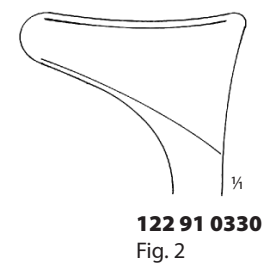
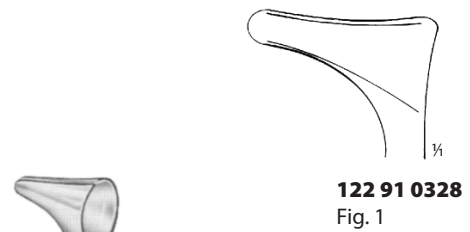

**MOD. WIEN**  
14,5 cm

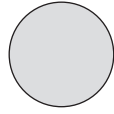
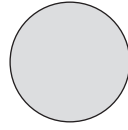
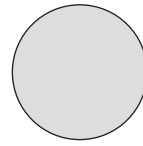
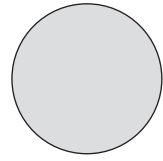
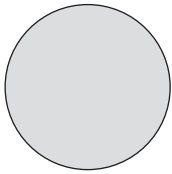
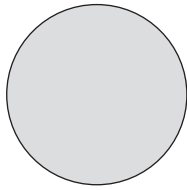
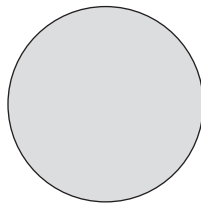
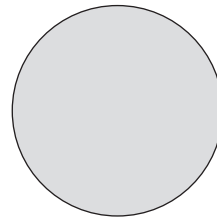
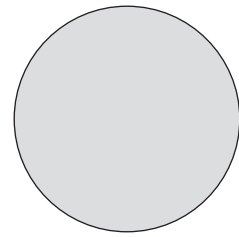
Fig. 00  
8 mmFig. 0  
10 mmFig. 1  
12 mmFig. 2  
14 mmFig. 3  
16 mmFig. 4  
18 mmFig. 5  
20 mmFig. 6  
22 mmFig. 7  
24 mmFig. 8  
26 mmFig. 9  
28 mmFig. 10  
30 mmDržadlo hrtanových zrcátek  
Handle  
**122 91 0172**Fig. 00 **122 91 0173**  
Fig. 0 **122 91 0174**  
Fig. 1 **122 91 0175**  
Fig. 2 **122 91 0176**  
Fig. 3 **122 91 0177**  
Fig. 4 **122 91 0178**  
Fig. 5 **122 91 0179**  
Fig. 6 **122 91 0180**  
Fig. 7 **122 91 0181**  
Fig. 8 **122 91 0182**  
Fig. 9 **122 91 0183**  
Fig. 10 **122 91 0184**Fig. 00 **122 91 0185**  
Fig. 0 **122 91 0186**  
Fig. 1 **122 91 0187**  
Fig. 2 **122 91 0188**  
Fig. 3 **122 91 0189**  
Fig. 4 **122 91 0190**  
Fig. 5 **122 91 0191**  
Fig. 6 **122 91 0192**  
Fig. 7 **122 91 0193**  
Fig. 8 **122 91 0194**  
Fig. 9 **122 91 0195**  
Fig. 10 **122 91 0196**

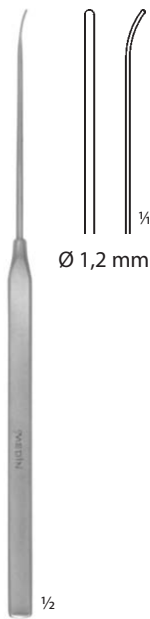

Páčka ušní  
Ear elevator  
**123 29 0010**  
16,0 cm



**LUCAE**  
14,0 cm

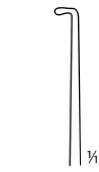

**123 29 0020**  
2 mm

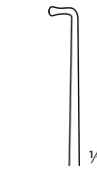

**123 29 0030**  
3 mm



**123 29 0040**  
4 mm

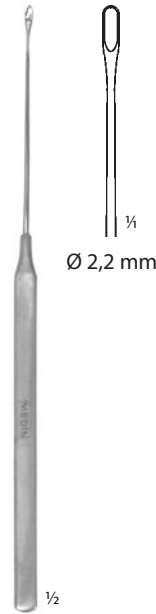

**LUCAE**  
**123 29 0080**  
16,0 cm



**LUCAE**  
14,0 cm



**133 91 0170**  
Fig. 1



**133 91 0171**  
Fig. 2



**133 91 0172**  
Fig. 3



**FISCH**  
16,0 cm



**133 91 0173**  
Fig. 1



**133 91 0174**  
Fig. 2



**133 91 0175**  
Fig. 3



**133 91 0176**  
Fig. 4

PÁČIDLA UŠNÍ  
EAR ELEVATORS

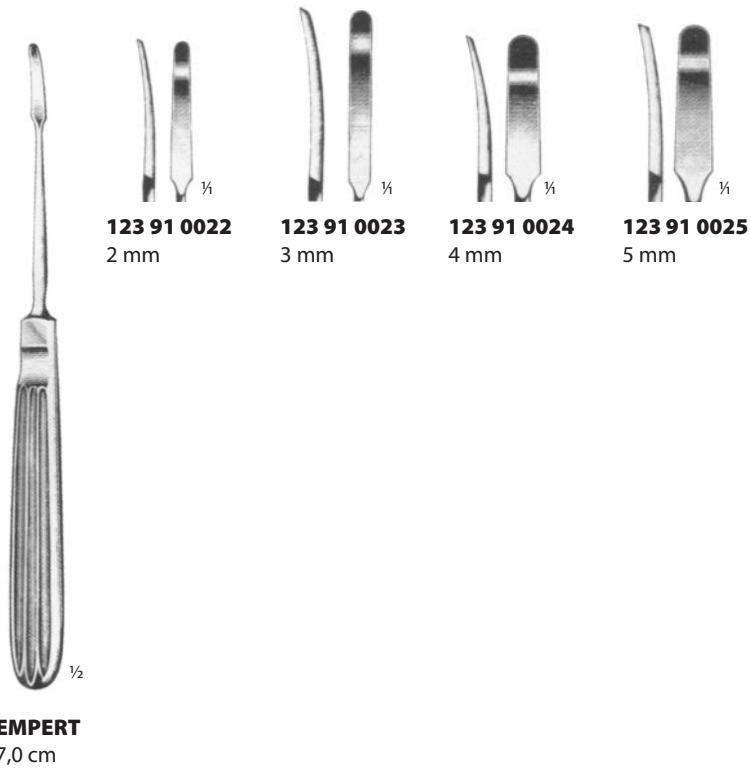

PÁČIDLA NOSNÍ  
NASAL ELEVATORS

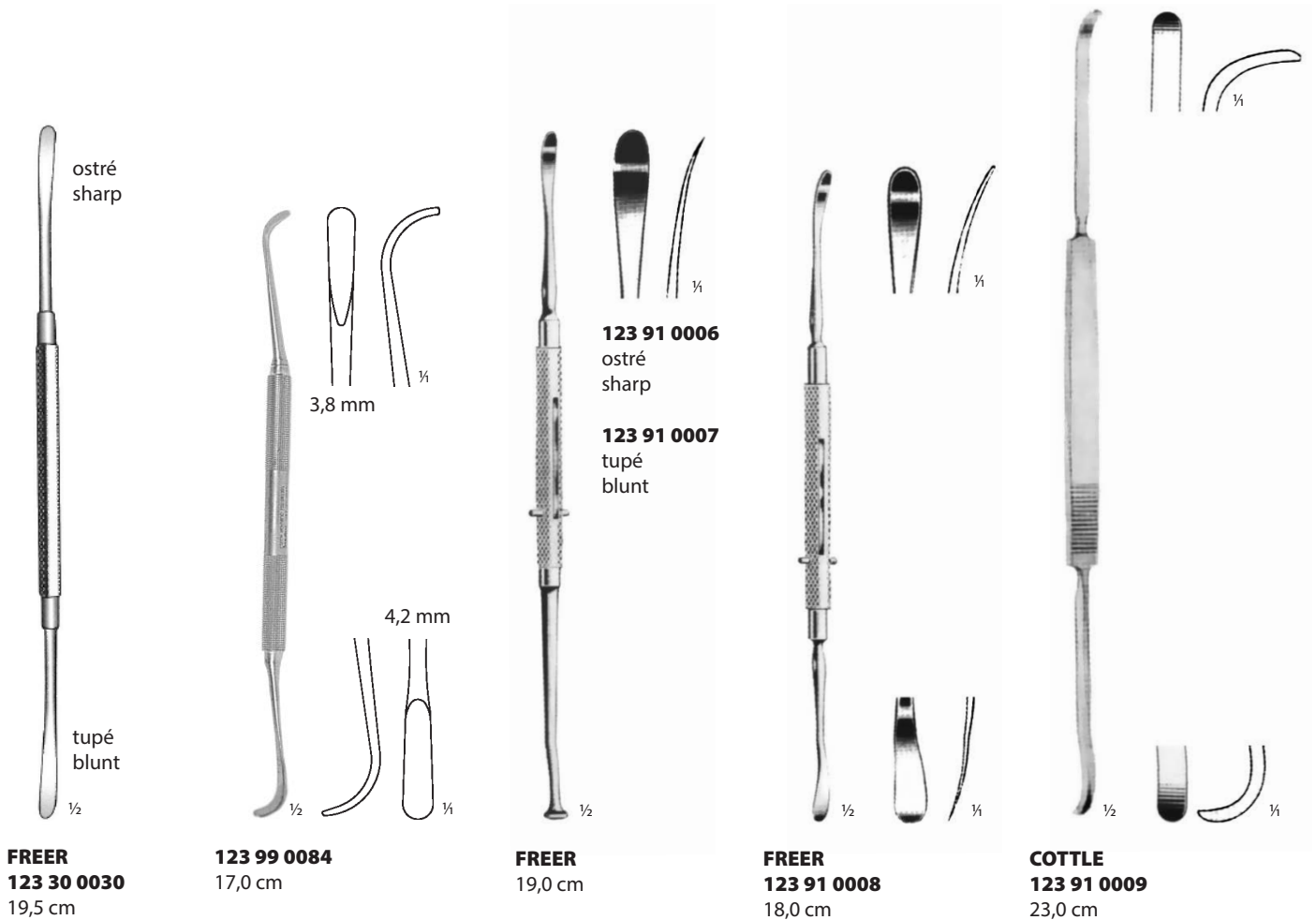





**McKENTY**  
**123 91 0010**  
22,0 cm

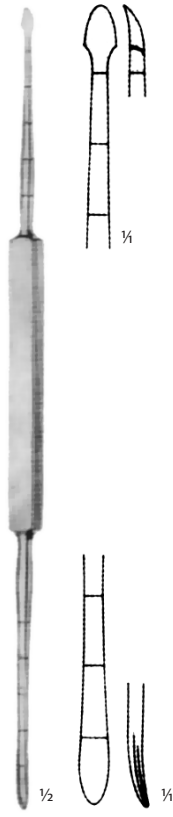

**COTTLE**  
**123 91 0011**  
21,0 cm



**MASING**  
**123 91 0012**  
21,0 cm



**HOWARTH**  
**123 91 0013**  
21,5 cm



**KILLIAN**  
**123 91 0014**  
18,0 cm

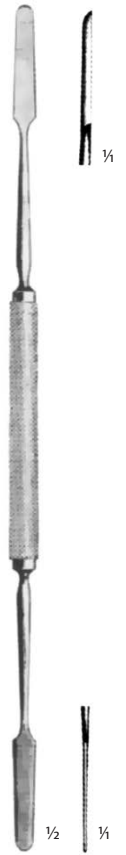

**KILLIAN**  
**123 91 0015**  
22,0 cm

PÁČIDLA NA NOSNÍ PŘEPÁŽKU  
SEPTUM AND PERIOSTEAL ELEVATORS

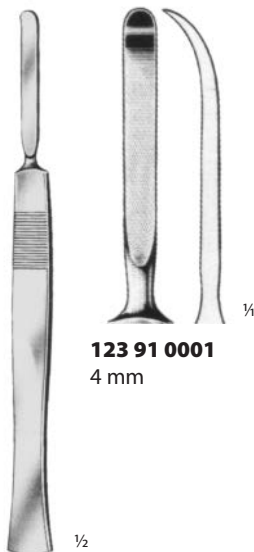

**123 91 0001**  
4 mm

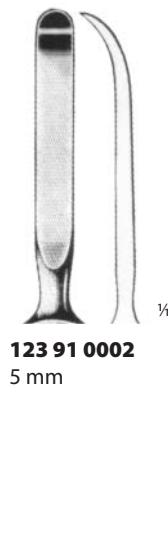

**123 91 0002**  
5 mm

**McKENTY**  
14,5 cm



**HALLE**  
**123 91 0004**  
16,5 cm



**JOSEPH**  
**123 91 0005**  
16,0 cm

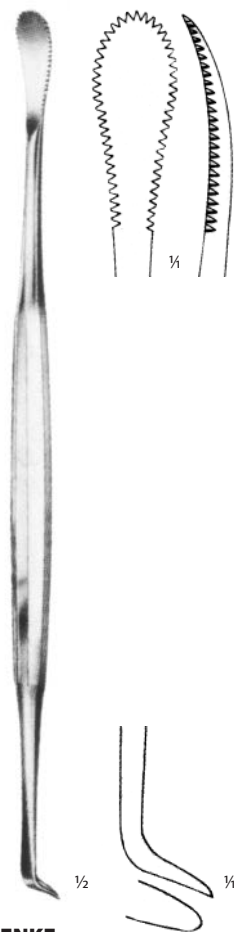

**HENKE**  
**123 91 0018**  
23,0 cm

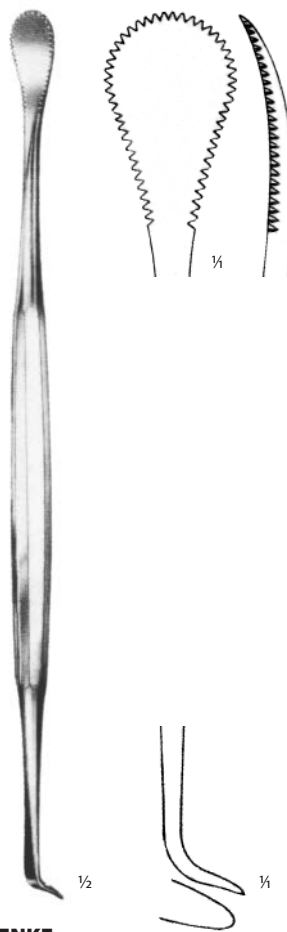

**HENKE**  
**123 91 0019**  
23,0 cm

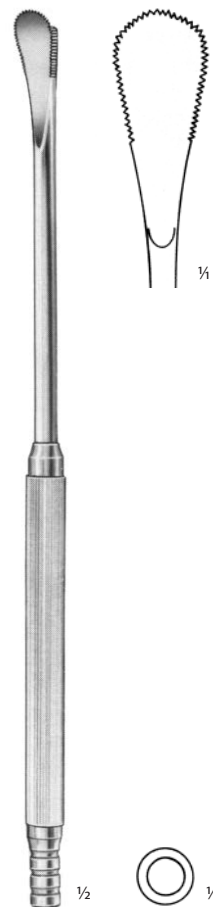

**LOPEZ-REINKE**  
**123 91 0020**  
23,5 cm



**LEMPERT**  
**124 91 0014**  
16,0 cm

ŠKRABKY NOSNÍ, NA MANDLE  
NASAL, TONSIL RASPATORIES

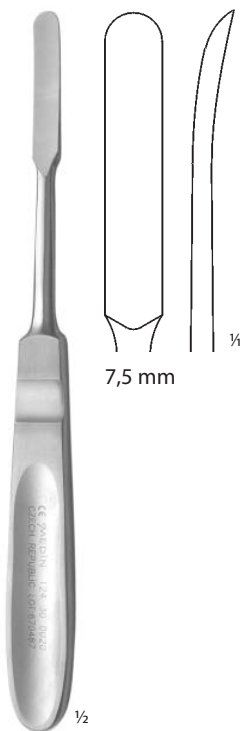

**PŘECHTĚL**  
**124 30 0020**  
19,0 cm

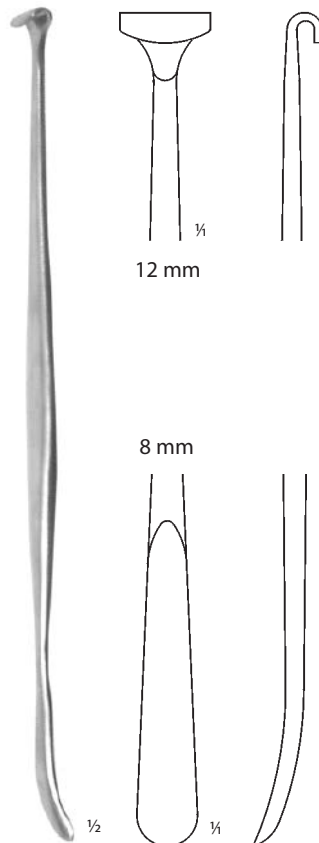

**HURD**  
**124 32 0010**  
21,0 cm



**HURD**  
22,5 cm



**124 91 0001**



**124 91 0002**



**126 91 0125**  
1,0 / 1,2 mm  
**126 91 0126**  
1,5 / 1,8 mm

**HOUSE**  
15,0 cm



**126 91 0127**  
1,0 / 1,2 mm  
**126 91 0128**  
1,5 / 1,8 mm

**HOUSE**  
15,0 cm

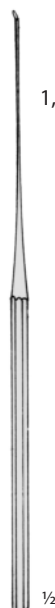

$\frac{1}{4}$   
1,5 × 2,5 mm

**SHEA**  
**126 91 0129**  
16,0 cm



$\frac{1}{4}$   
1,5 × 2,5 mm

**SHEA**  
**126 91 0130**  
16,0 cm  
lomená  
angled



**LEMPERT**  
21,0 cm

$\frac{1}{4}$   
**126 91 0131**  
Fig. 0

$\frac{1}{4}$   
**126 91 0132**  
Fig. 00

$\frac{1}{4}$   
**126 91 0133**  
Fig. 000

$\frac{1}{4}$   
**126 91 0134**  
Fig. 0000

$\frac{1}{4}$   
**126 91 0135**  
Fig. 00000



ostré – sharp

tupé – blunt



**BUCK**  
16,5 cm

<b>126 91 0010</b>	<b>126 91 0011</b>	<b>126 91 0012</b>	<b>126 91 0013</b>	<b>126 91 0014</b>	<b>126 91 0015</b>	<b>126 91 0016</b>	<b>126 91 0017</b>
Fig. 000	Fig. 00	Fig. 0	Fig. 1	Fig. 2	Fig. 3	Fig. 4	Fig. 5



**SHAPLEIGH**  
13,0 cm



**126 91 0018**  
Fig. 1



**126 91 0019**  
Fig. 2

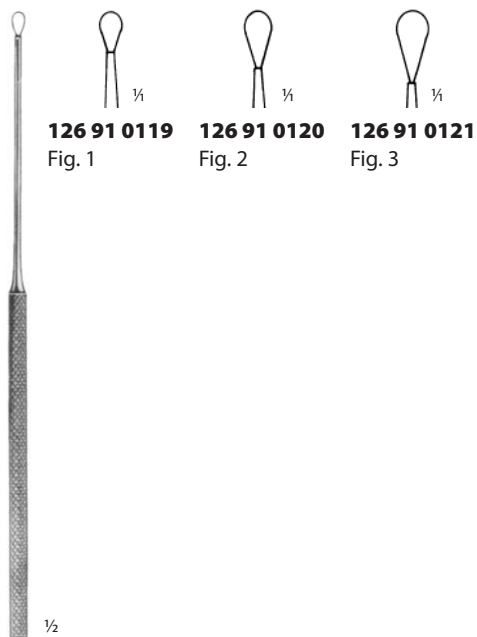
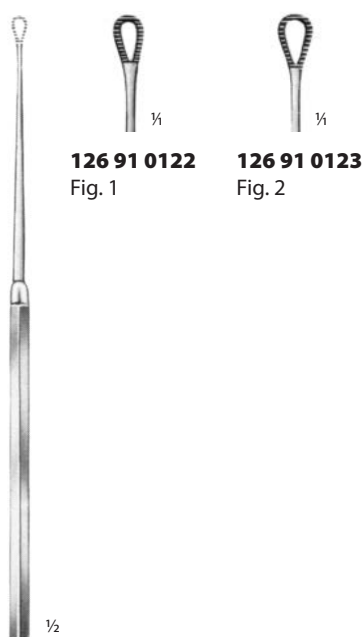
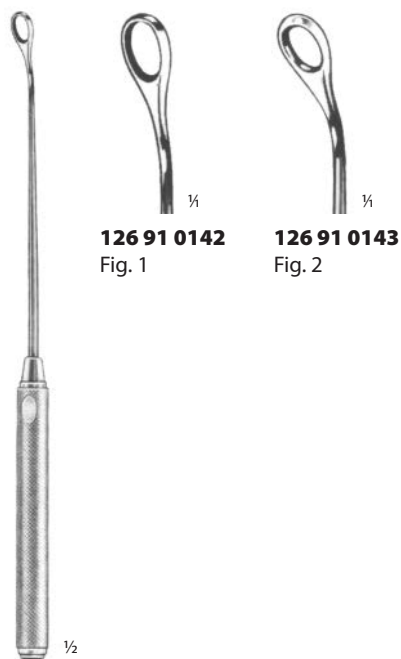
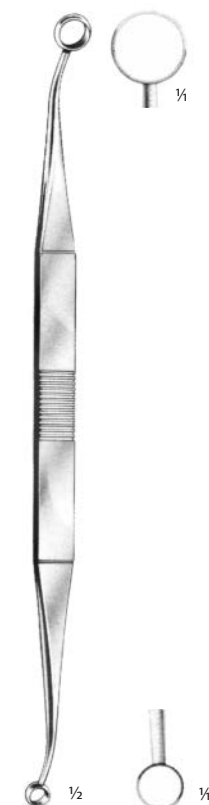

**LANGENBECK**  
**126 91 0020**  
13,0 cm

SMYČKY UŠNÍ  
LOOPS**BILLEAU**  
16,5 cm**SNELLEN**  
16,5 cm**GROSS**  
**126 91 0124**  
12,0 cmKYRETY NOSNÍ  
NASAL CURETTES**COAKLEY**  
17,0 cm  
ostrá  
sharp**FAULKNER**  
**126 91 0148**  
21,0 cm**SEWALL**  
**126 91 0149**  
20,0 cm

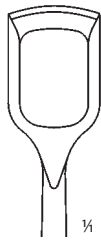

**112 30 0300**  
22,0 cm  
Fig. 1

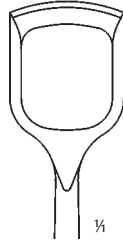

**112 30 0310**  
22,0 cm  
Fig. 2

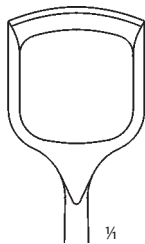

**112 30 0320**  
22,0 cm  
Fig. 3

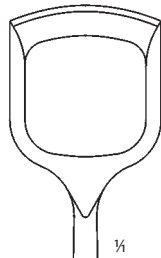

**112 30 0330**  
22,0 cm  
Fig. 4



**112 91 0274**  
22,0 cm  
Fig. 1

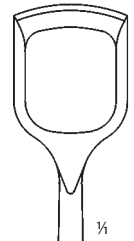

**112 91 0275**  
22,0 cm  
Fig. 2



**112 91 0272**  
22,0 cm  
Fig. 5



**112 91 0273**  
22,0 cm  
Fig. 6

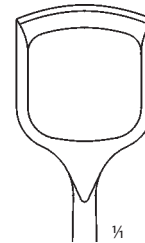

**112 91 0276**  
22,0 cm  
Fig. 3

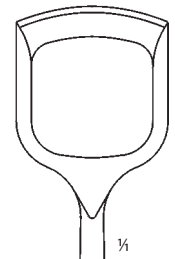

**112 91 0277**  
22,0 cm  
Fig. 4



**112 91 0278**  
22,0 cm  
Fig. 5



**112 91 0279**  
22,0 cm  
Fig. 6



**BECKMANN**

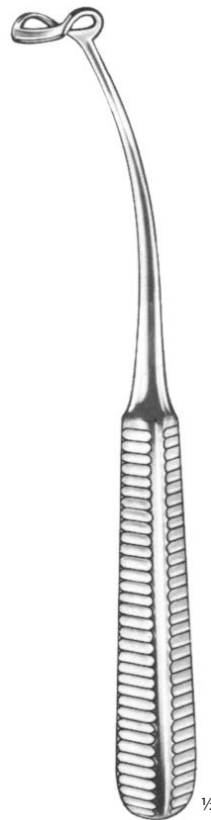

**BECKMANN**  
zahnutá  
curved

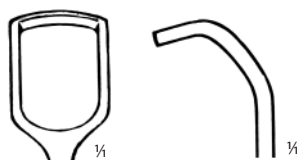

**112 91 0280**  
22,0 cm  
Fig. 1

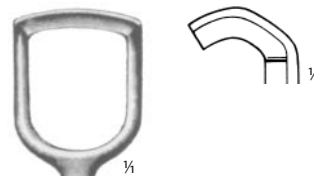

**112 91 0095**  
21,0 cm  
Fig. 1

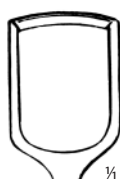

**112 91 0281**  
22,0 cm  
Fig. 2



**112 91 0096**  
21,0 cm  
Fig. 2



**BARNHILL**

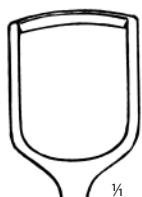

**112 91 0282**  
22,0 cm  
Fig. 3



**ST.CLAIR-THOMPSON**



**112 91 0097**  
21,0 cm  
Fig. 3

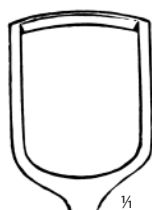

**112 91 0283**  
22,0 cm  
Fig. 4



**112 91 0098**  
21,0 cm  
Fig. 4



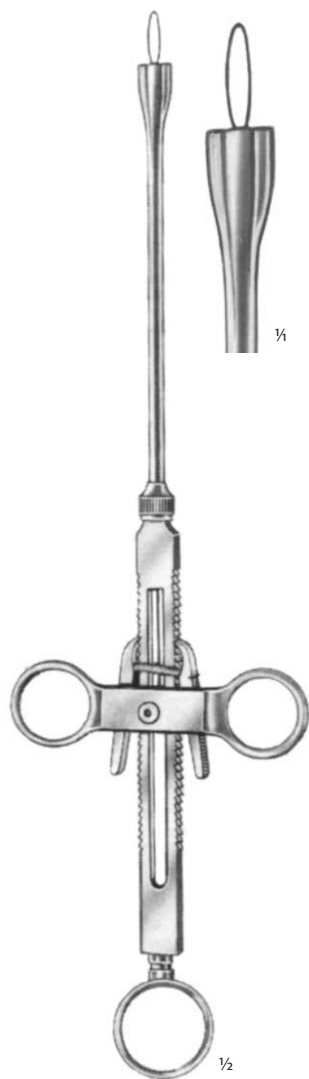

**BRUENINGS**  
**126 91 0001**  
28,0 cm



**126 32 0080**  
5,0 cm  
Ø 0,3 mm



**126 32 0090**  
5,0 cm  
Ø 0,4 mm



**126 32 0110**  
5,0 cm  
Ø 0,5 mm



**126 32 0120**  
4,0 cm  
Ø 0,3 mm



**126 32 0130**  
4,0 cm  
Ø 0,4 mm



**126 32 0140**  
4,0 cm  
Ø 0,5 mm



**126 32 0160**  
4,5 cm  
Ø 0,4 mm

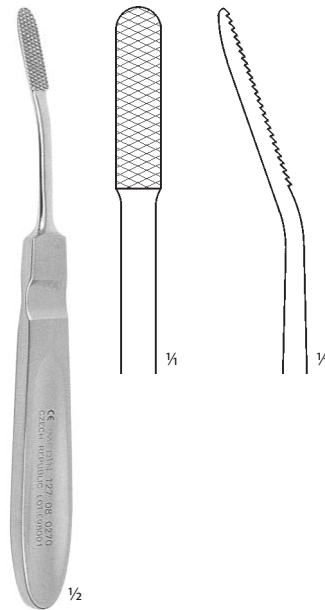

Pilník  
Rasp  
**127 08 0270**  
15,9 cm

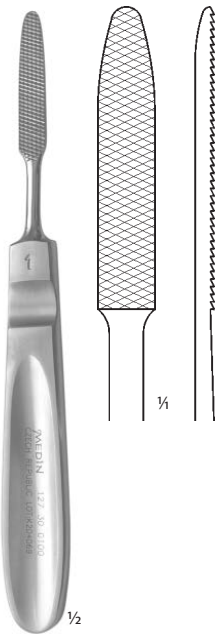

**JOSEPH**  
**127 30 0100**  
16,5 cm  
Fig. 1

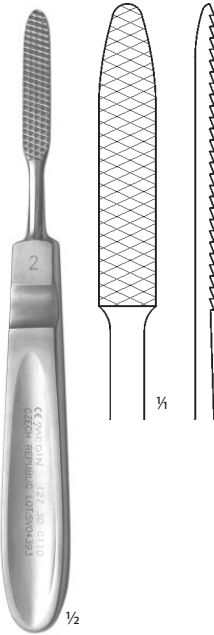

**JOSEPH**  
**127 30 0110**  
16,5 cm  
Fig. 2

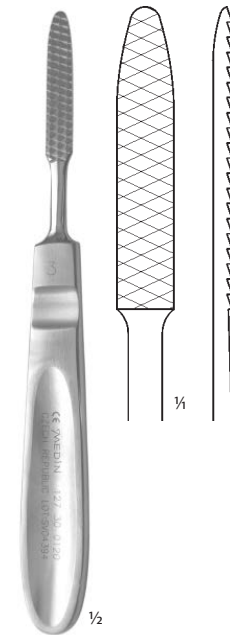

**JOSEPH**  
**127 30 0120**  
16,5 cm  
Fig. 3

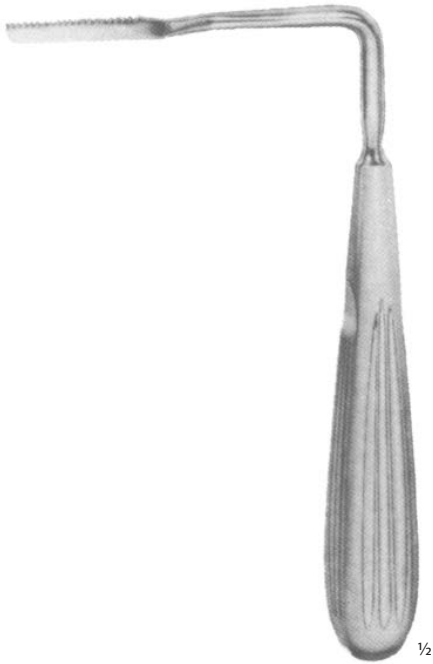

**JOSEPH**  
**127 91 0010**  
17,0 cm  
levá  
left

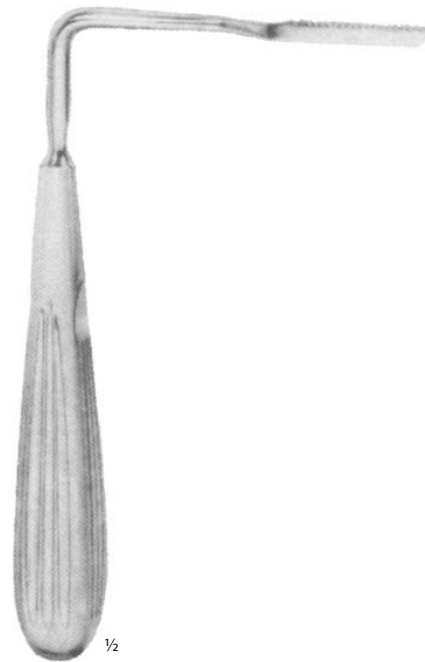

**JOSEPH**  
**127 91 0011**  
17,0 cm  
pravá  
right



**JOSEPH**  
19,0 cm

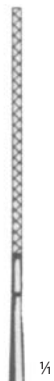

**127 91 0012**  
rovná  
straight



**127 91 0013**  
vyhnutá vlevo  
angled on left



**127 91 0014**  
vyhnutá vpravo  
angled on right

PILNÍKY NOSNÍ  
NASAL RASPS



**LEWIS**  
18,0 cm

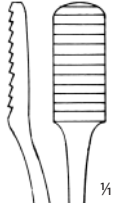

**127 91 0015**  
Fig. 1

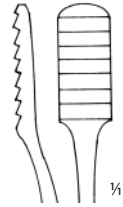

**127 91 0016**  
Fig. 2



**COTTLE**  
**127 91 0017**  
21,0 cm



**MALTZ**  
**127 91 0020**  
18,0 cm

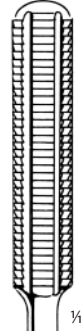

**AUFRICHT**  
21,0 cm

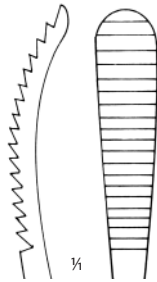

**127 91 0018**  
Fig. 1

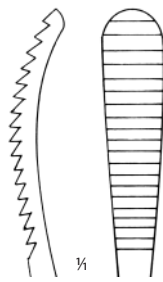

**127 91 0019**  
Fig. 2



**GALLAGHER**  
16,0 cm



**127 91 0021**  
rovný  
straight



**127 91 0022**  
vyhnutý vlevo  
curved on left



**127 91 0023**  
vyhnutý vpravo  
curved on right



**WIENER**  
18,0 cm



**127 91 0024**  
Fig. 1



**127 91 0025**  
Fig. 2

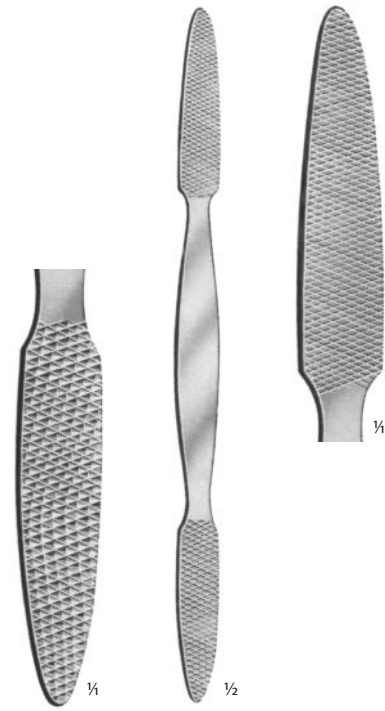

**CONVERSE**  
**127 91 0026**  
18,5 cm

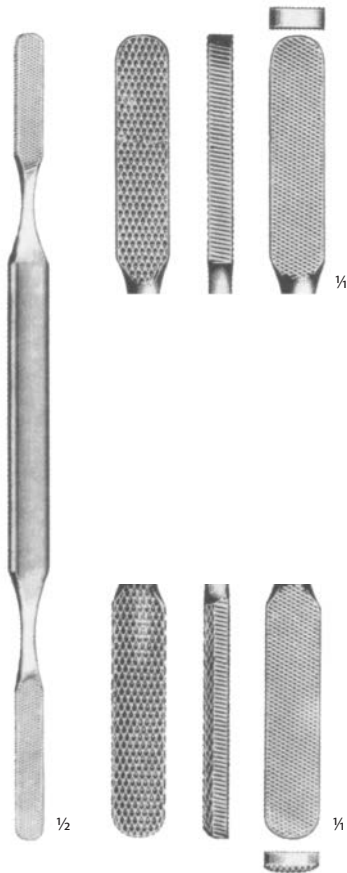

**FOMON**  
**127 91 0027**  
21,0 cm



**MASING**  
**127 91 0028**  
21,0 cm



**MASING**  
**127 91 0029**  
21,0 cm

PILNÍKY NOSNÍ  
NASAL RASPS



**127 91 0030**  
Fig. 1



**127 91 0031**  
Fig. 2



**127 91 0032**  
Fig. 3



**127 91 0033**  
Fig. 4



**127 91 0034**  
Fig. 5



**MILLER-COLBURN**  
19,0 cm



**127 91 0035**  
Fig. 1



**127 91 0036**  
Fig. 2



**127 91 0037**  
Fig. 3



**127 91 0038**  
Fig. 4



**127 91 0039**  
Fig. 5



**MILLER-COLBURN**  
19,0 cm



**COTTLE**  
**127 91 0042**  
21,0 cm



¼



**LEWIS**  
18,0 cm

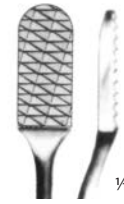

**127 91 0040**  
Fig. 1

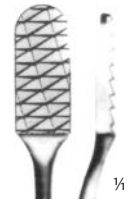

**127 91 0041**  
Fig. 2



**FOMON**  
20,0 cm



**127 91 0043**  
Fig. 1

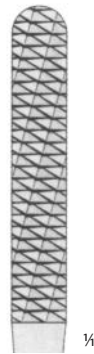

**127 91 0044**  
Fig. 2



**127 91 0045**  
Fig. 3



**127 91 0046**  
Fig. 4

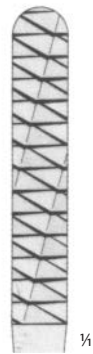

**127 91 0047**  
Fig. 5



¼

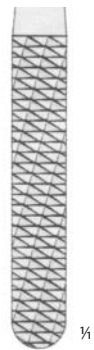

¼



¼



¼



¼

DLÁTA NOSNÍ  
NASAL GOUGES

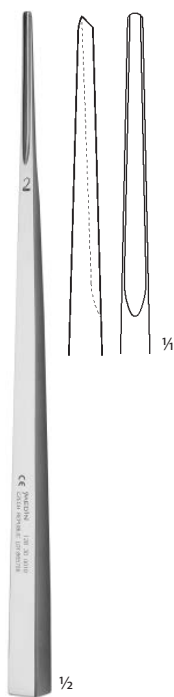

**128 30 0010**  
18,0 cm  
2 mm

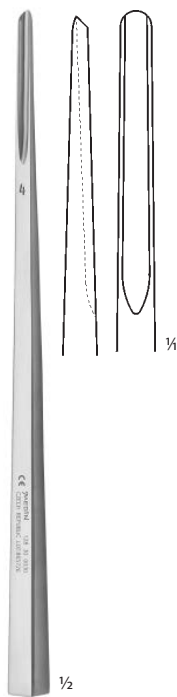

**128 30 0030**  
18,0 cm  
4 mm

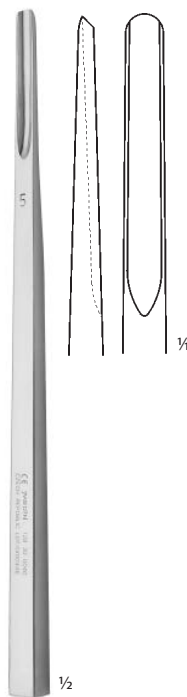

**128 30 0040**  
18,0 cm  
5 mm

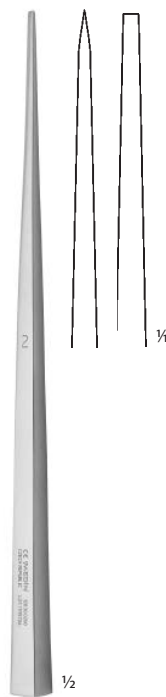

**WEST 128 30 0200**  
18,0 cm  
2 mm

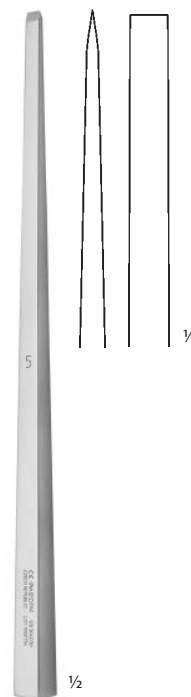

**WEST 128 30 0230**  
18,0 cm  
5 mm

DLÁTA NA NOSNÍ PLASTIKU  
NASAL PLASTIC CHISELS



**128 12 0120**  
rovne  
straight  
19,0 cm  
Fig. 1

**128 12 0130**  
rovne  
straight  
19,0 cm  
Fig. 1

**128 12 0140**  
rovne  
straight  
19,0 cm  
Fig. 1



**128 12 0160**  
18,0 cm  
Fig. 2

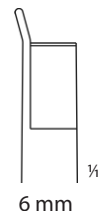

**128 12 0170**  
18,0 cm  
Fig. 2

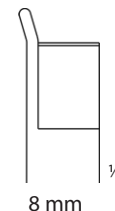

**128 12 0200**  
18,0 cm  
Fig. 2

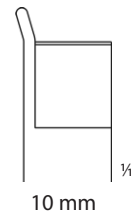

**128 12 0180**  
18,0 cm  
Fig. 2





**FREER**  
**128 91 0160**  
16,0 cm



**FREER**  
**128 91 0161**  
16,0 cm



**WEST**  
**128 91 0162**  
16,0 cm



**WEST**  
**128 91 0163**  
16,0 cm



**FREER**  
**128 91 0164**  
15,0 cm

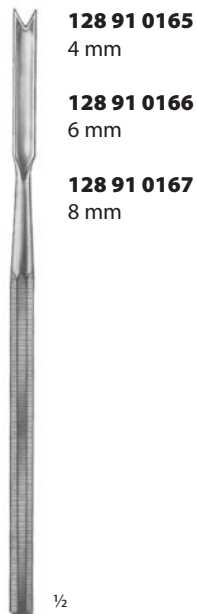

**BALLENGER**  
**128 91 0166**  
16,0 cm



**KILLIAN**  
**128 91 0168**  
16,0 cm



**KILLIAN-CLAUS**  
**128 91 0169**  
17,0 cm



**128 91 0170**  
4 mm



**128 91 0171**  
7 mm



**128 91 0172**  
9 mm



**128 91 0173**  
12 mm

**COTTLE**  
18,0 cm

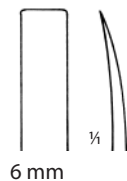

**COTTLE**  
**128 91 0174**  
18,0 cm

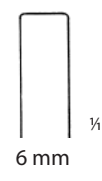
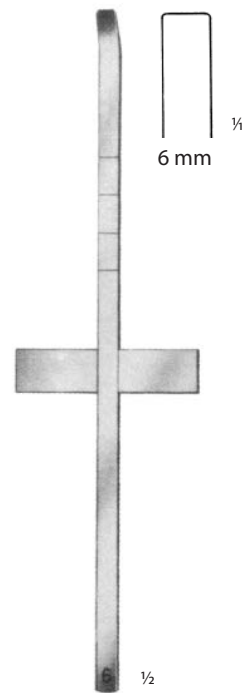

**COTTLE**  
**128 91 0175**  
18,0 cm

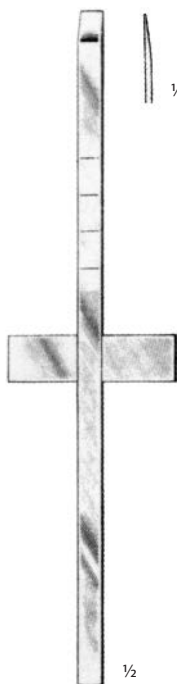

**128 91 0176**  
4 mm



**128 91 0177**  
7 mm



**128 91 0178**  
9 mm



**128 91 0179**  
12 mm

**COTTLE**  
18,0 cm

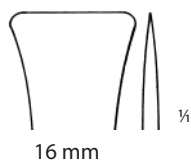
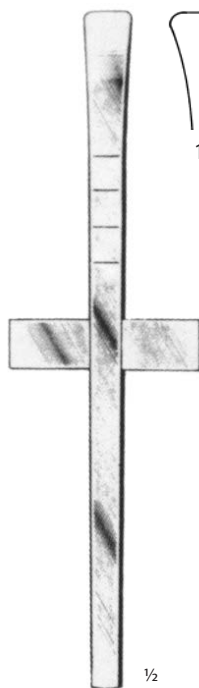

**COTTLE**  
**128 91 0180**  
18,0 cm

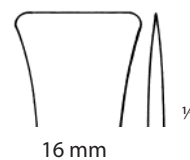
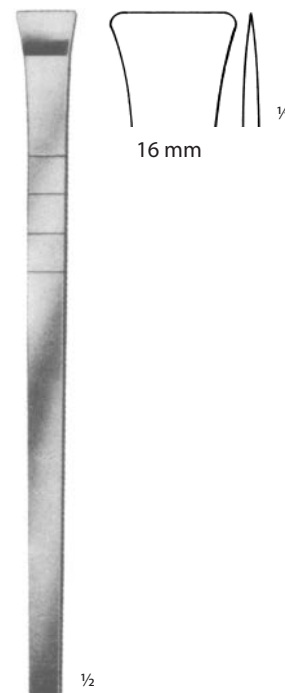

**COTTLE**  
**128 91 0181**  
18,0 cm

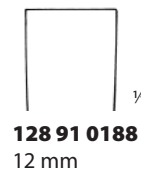
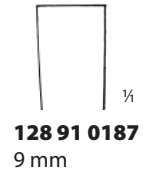
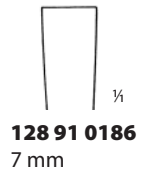
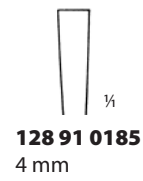
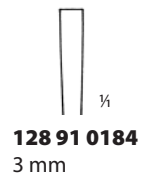
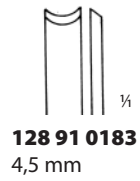

**WALTER**  
19,0 cm

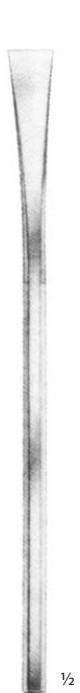

**SHEEHAN**  
17,0 cm

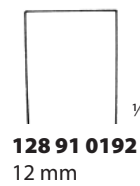
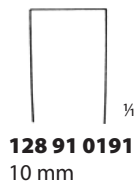
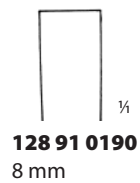
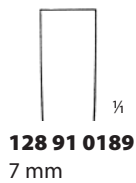

**RUBIN**  
18,0 cm

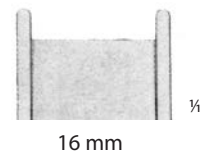
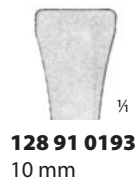

**CINELLI**  
**128 91 0196**  
18,0 cm



**MASING**  
**128 91 0197**  
17,5 cm



**MASING**  
**128 91 0198**  
17,5 cm  
rovné  
straight



**MASING**  
**128 91 0199**  
17,5 cm  
Fig. 1



**MASING**  
**128 91 0200**  
17,5 cm  
Fig. 2

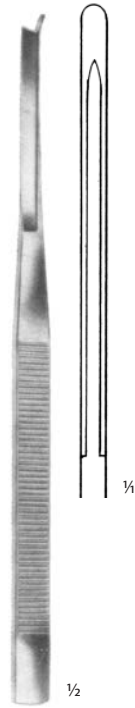

**SILVER**  
**128 91 0201**  
18,0 cm  
rovné  
straight

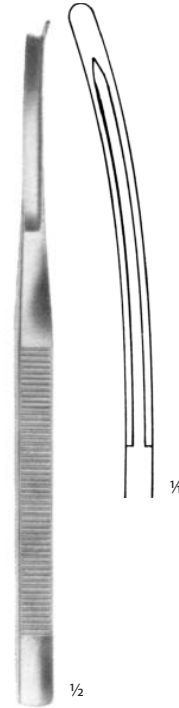

**SILVER**  
**128 91 0202**  
18,0 cm  
Fig. 0

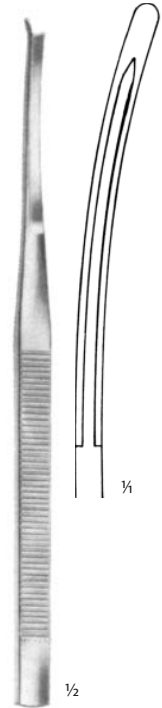

**SILVER**  
**128 91 0203**  
18,0 cm  
Fig. 2



**NEIVERT**  
**128 91 0204**  
20,0 cm  
rovné  
straight



**ANDERSON-NEIVERT**  
**128 91 0205**  
20,0 cm  
Fig. 1



**ANDERSON-NEIVERT**  
**128 91 0206**  
20,0 cm  
Fig. 2



**CONVERSE**  
**128 91 0208**  
19,0 cm  
Fig. 1

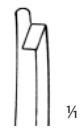

**CONVERSE**  
**128 91 0209**  
19,0 cm  
Fig. 2



**CONVERSE**  
**128 91 0207**  
19,0 cm  
Fig. 0



Fréza nerezová  
Rosen bur, stainless steel  
7,0 cm  
průměr stopky 2,35 mm  
diameter of shank 2,35 mm

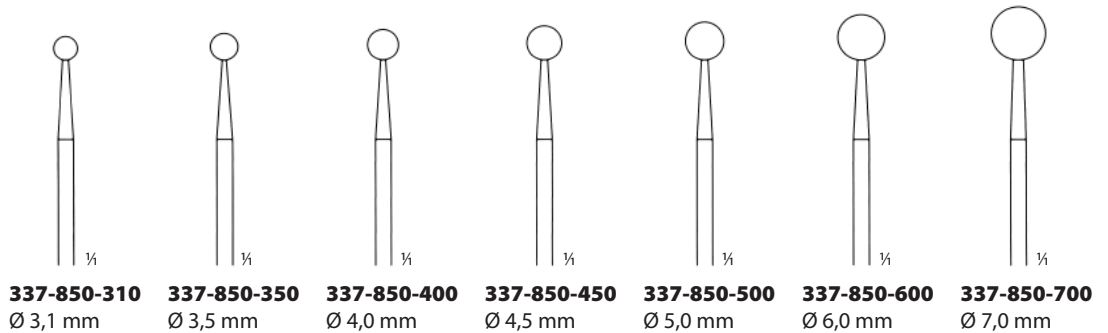
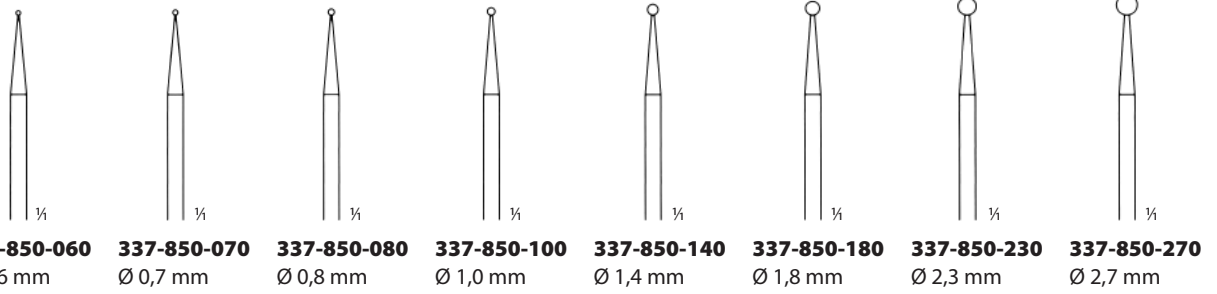

Fréza nerezová  
Rosen bur, stainless steel  
9,5 cm  
průměr stopky 2,35 mm  
diameter of shank 2,35 mm

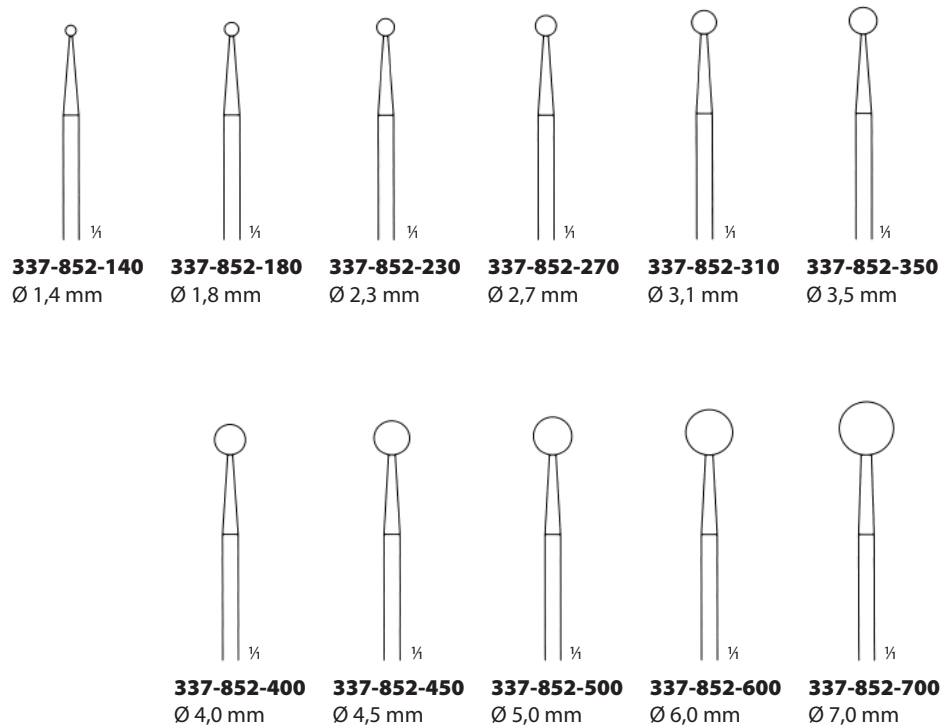

FRÉZY PRO ORL  
ENT BURS

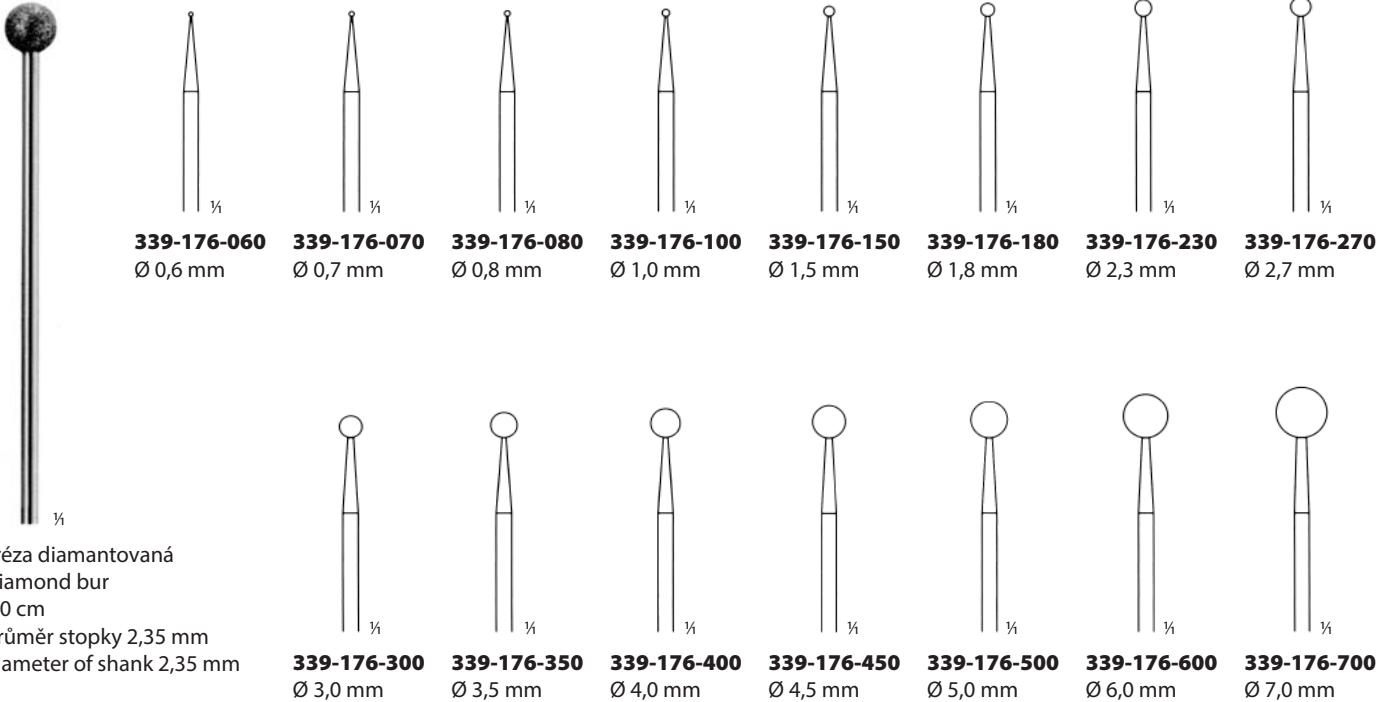

Fréza diamantovaná  
Diamond bur  
7,0 cm  
průměr stopky 2,35 mm  
diameter of shank 2,35 mm

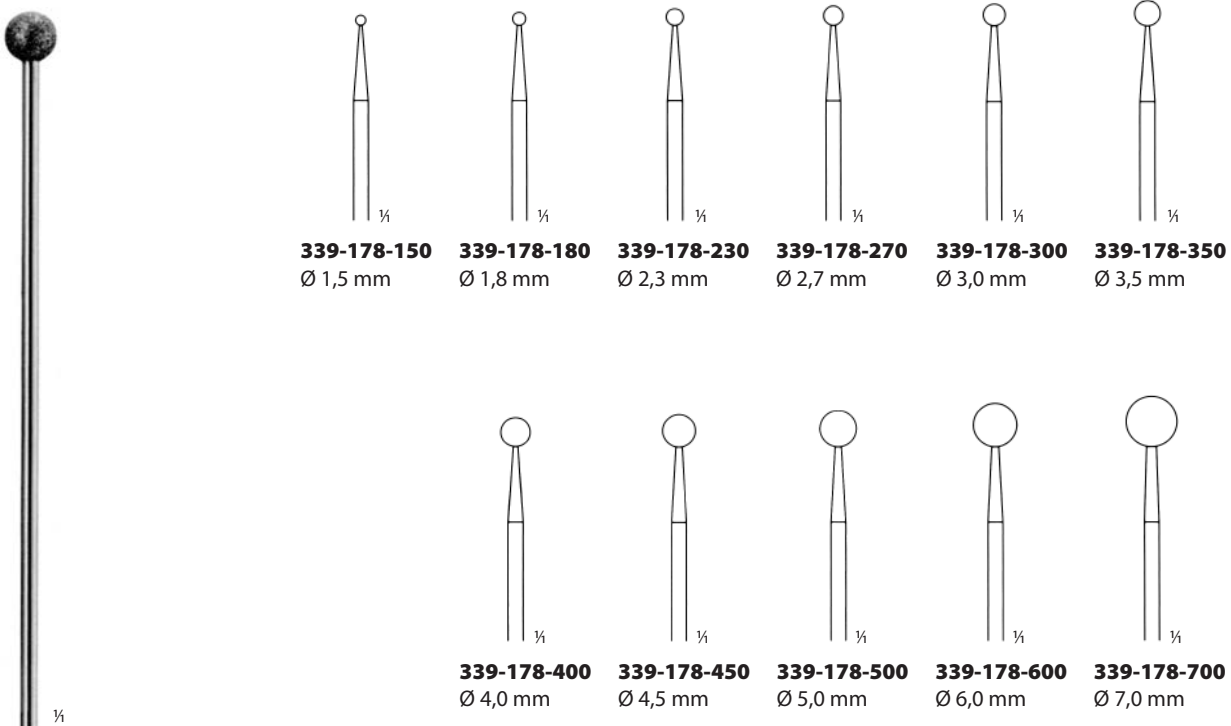

Fréza diamantovaná  
Diamond bur  
9,5 cm  
průměr stopky 2,35 mm  
diameter of shank 2,35 mm



Pátradlo ušní  
Aural probe  
**133 29 0010**  
9,5 cm  
Ø 1 mm



Pátradlo nosní  
Nasal probe  
**133 30 0030**  
13,7 cm  
Ø 1,6 mm



Drátek na výtěry  
Swab wire  
**133 29 0110**  
14,0 cm  
balení 1000 ks  
packing 1000 pcs

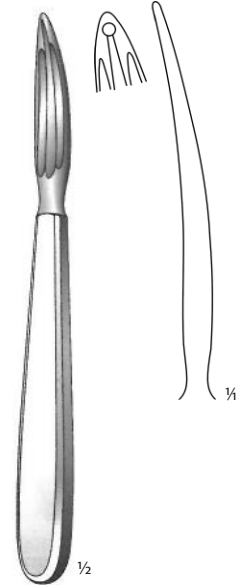

**KOCHER**  
Pátradlo na strumu  
Goitre probe  
**133 35 0010**  
15,0 cm

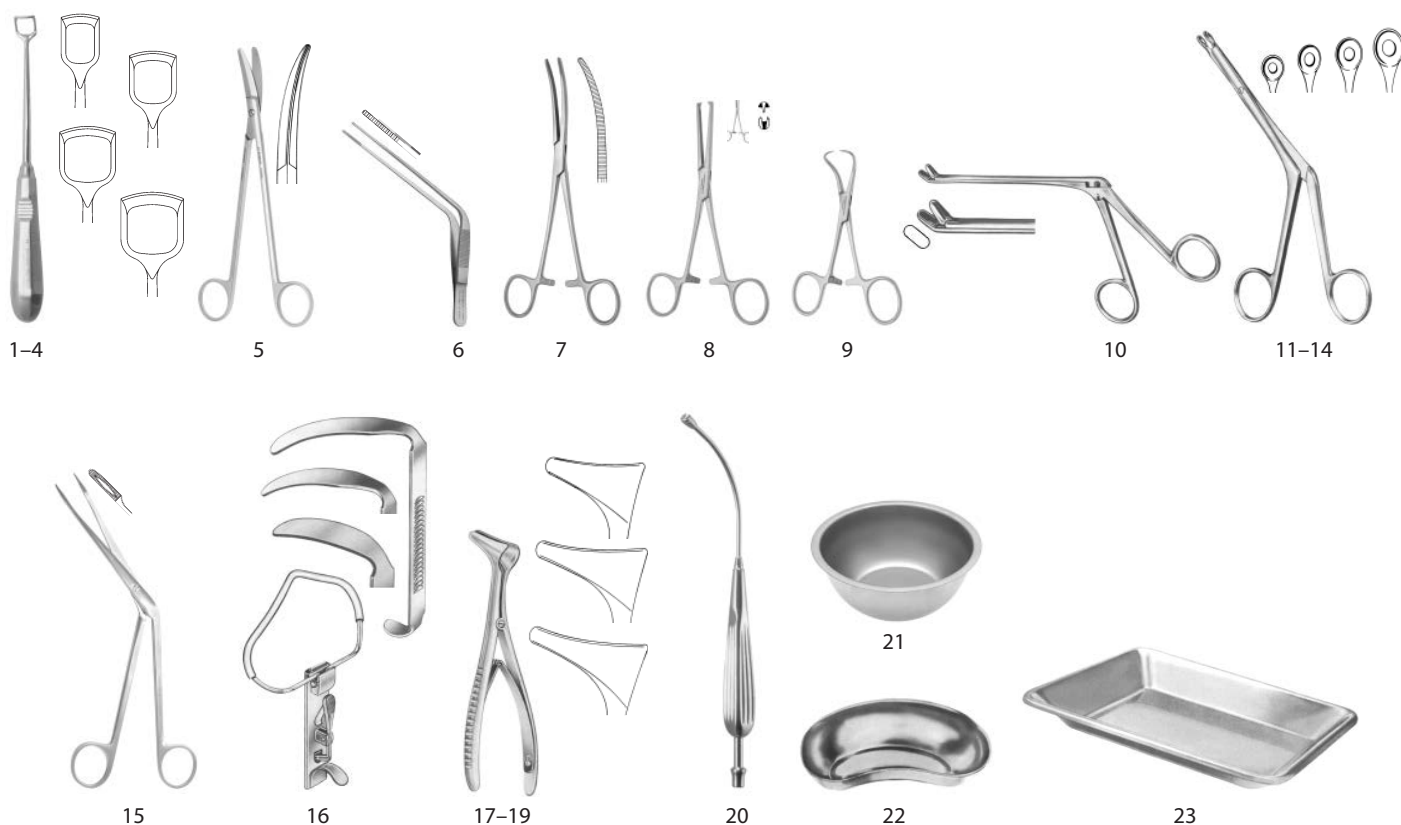
SET PRO ADENOTOMII  
SET FOR ADENOIDECTOMY

## Doporučený set pro adenotomii

1	<b>112 30 0300</b>	Beckmann kyreta nosohltanová fig.1; 22,0 cm
2	<b>112 30 0310</b>	Beckmann kyreta nosohltanová fig.2; 22,0 cm
3	<b>112 30 0320</b>	Beckmann kyreta nosohltanová fig.3; 22,0 cm
4	<b>112 30 0330</b>	Beckmann kyreta nosohltanová fig.4; 22,0 cm
5	<b>113 32 0010</b>	Prince nůžky na mandle; 18,5 cm
6	<b>114 30 0010</b>	Troeltsch pinzeta nosní jemná; 16,0 cm
7	<b>115 91 0128</b>	Rochester-Pean svorka na cévy zahnutá; 20,0 cm
8	<b>115 91 0133</b>	Ochsner-Kocher svorka na cévy rovná; 14,0 cm
9	<b>115 91 0343</b>	Backhaus svorka na prádlo; 11,0 cm
10	<b>116 91 0201</b>	Weil-Blakesley kleště štípací nosní; 12,5 cm
11	<b>116 91 0228</b>	Bruenings kleště na nosní přepážku; 19,0 cm
12	<b>116 91 0229</b>	Bruenings kleště na nosní přepážku; 19,0 cm
13	<b>116 91 0230</b>	Bruenings kleště na nosní přepážku; 19,0 cm
14	<b>116 91 0231</b>	Bruenings kleště na nosní přepážku; 19,0 cm
15	<b>117 91 0216</b>	Hartmann kleště nosní na polypy; 20,0 cm
16	<b>119 91 0222</b>	Mc Ivor rozvěrač úst komplet
17	<b>122 91 0302</b>	Hartmann zrcátko nosní fig.1; 15,0 cm
18	<b>122 91 0304</b>	Hartmann zrcátko nosní fig.2; 15,0 cm
19	<b>122 91 0306</b>	Hartmann zrcátko nosní fig.3; 15,0 cm
20	<b>38-523-235</b>	Andrew-Pynchon odsávačka; 23,5 cm
21	<b>136 91 0081</b>	Miska; 0,45 l; 12,8×5,5 cm
22	<b>136 91 0088</b>	Miska; 25,0 cm
23	<b>136 91 0097</b>	Tác; 23,0×15,5×3,0 cm

## Recommended set for adenoidectomy

	ks/pcs
Beckmann adenoid curette fig.1; 22.0 cm	1
Beckmann adenoid curette fig.2; 22.0 cm	1
Beckmann adenoid curette fig.3; 22.0 cm	1
Beckmann adenoid curette fig.4; 22.0 cm	1
Prince tonsil scissors; 18.5 cm	1
Troeltsch nasal forceps; 16.0 cm	2
Rochester-Pean artery forceps curved; 20.0 cm	2
Ochsner-Kocher artery forceps straight; 14.0 cm	2
Backhaus towel forceps; 11.0 cm	2
Weil-Blakesley nasal cutting forceps; 12.5 cm	1
Bruenings septum forceps; 19.0 cm	1
Bruenings septum forceps; 19.0 cm	1
Bruenings septum forceps; 19.0 cm	1
Bruenings septum forceps; 19.0 cm	1
Hartmann nasal polypus forceps; 20.0 cm	1
Mc Ivor mouth retractor set	1
Hartmann nasal speculum fig.1; 15.0 cm	1
Hartmann nasal speculum fig.2; 15.0 cm	1
Hartmann nasal speculum fig.3; 15.0 cm	1
Andrew-Pynchon suction tube; 23.5 cm	2
Bowl; 0.45 l; 12.8×5.5 cm	2
Bowl; 25.0 cm	1
Tray; 23.0×15.5×3.0 cm	1



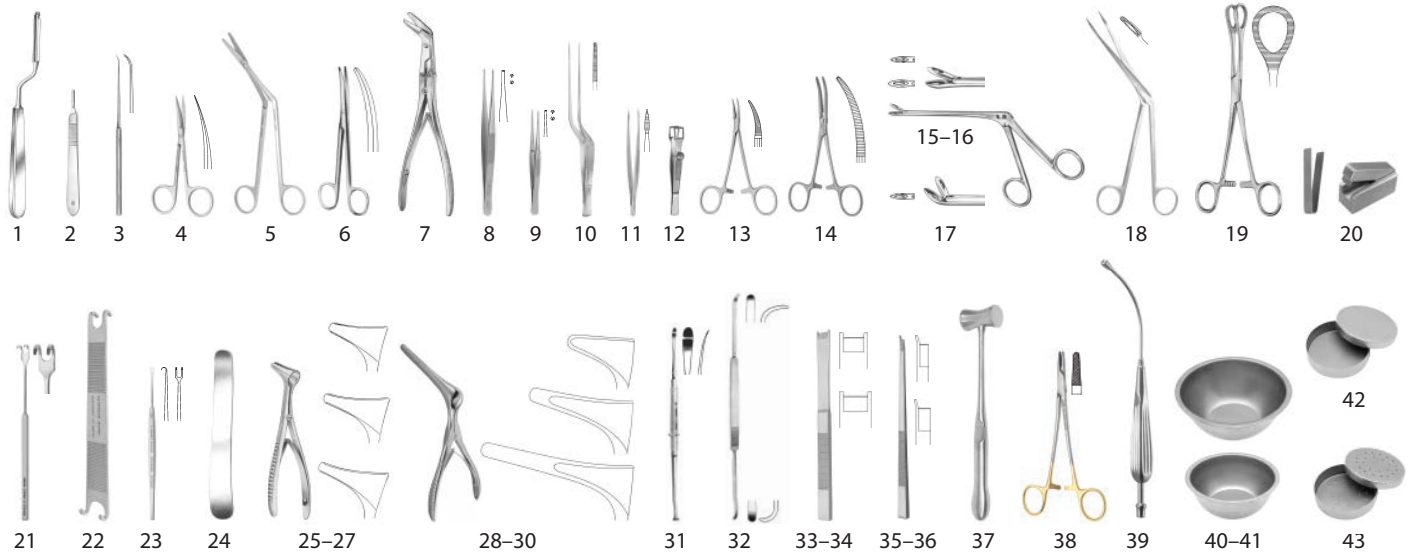

**Doporučený set pro septoplastiku**

1	<b>112 30 0260</b>	Ballenger nůž na nosní přepážku fig.1; 20,0 cm
2	<b>112 91 0003</b>	Držátko skalpelových čepelek č.3
3	<b>112 91 0151</b>	Rosen jehla zahnutá; 16,0 cm
4	<b>113 12 0020</b>	Nůžky preparační s oboustranným ostřím zahnuté; 12,0 cm
5	<b>113 30 0010</b>	Heymann nůžky nosní lomené; 18,0 cm
6	<b>113 91 0101</b>	Mayo-Stille nůžky preparační tupé zahnuté; 15,0 cm
7	<b>113 91 0676</b>	Killian nůžky na septum; 20,0 cm
8	<b>114 08 0530</b>	Pinzeta chirurgická velmi jemná; 1×2 zuby; 14,5 cm
9	<b>114 38 0160</b>	Graefe pinzeta oční rovná jemná; 1×2 zuby; 10,5 cm
10	<b>114 91 0139</b>	Taylor pinzeta anatomická bajonetová; 17,5 cm
11	<b>114 08 0980</b>	Pinzeta na třísky; 14,0 cm
12	<b>08-875-110</b>	Pinzeta na columellu; 11,0 cm
13	<b>115 08 1020</b>	Mosquito-Halsted svorka na cévy zahnutá jemná; 12,0 cm
14	<b>115 91 0125</b>	Rochester-Pean svorka na cévy zahnutá; 14,0 cm
15	<b>116 91 0192</b>	Weil-Blakesley kleště štípací nosní; 12,5 cm
16	<b>116 91 0193</b>	Weil-Blakesley kleště štípací nosní; 12,5 cm
17	<b>116 91 0197</b>	Weil-Blakesley kleště štípací nosní; 12,5 cm
18	<b>117 91 0216</b>	Hartmann kleště nosní na polypy; 20,0 cm
19	<b>117 91 0038</b>	Heywood-Smith kleště tamponové; 21,0 cm
20	<b>437-648-000</b>	Cottle drtič chrupavky
21	<b>118 08 0060</b>	Hák jemný na rány dvouzubý tupý; 16,0 cm
22	<b>118 12 0090</b>	Hák na křídlo nosní oboustranný; 10,5 cm
23	<b>118 38 0220</b>	Hák jemný oční dvouzubý ostrý; 3,2 mm; 13,5 cm
24	<b>121 91 0023</b>	Mayo držák jazyka; 17,0 cm
25	<b>122 91 0302</b>	Hartmann zrcátko nosní fig.1; 15,0 cm
26	<b>122 91 0304</b>	Hartmann zrcátko nosní fig.2; 15,0 cm
27	<b>122 91 0306</b>	Hartmann zrcátko nosní fig.3; 15,0 cm
28	<b>46-041-001</b>	Killian zrcátko nosní; 35 mm; 13,0 cm
29	<b>46-041-002</b>	Killian zrcátko nosní; 50 mm; 13,0 cm
30	<b>46-041-003</b>	Killian zrcátko nosní; 75 mm; 13,0 cm
31	<b>123 91 0006</b>	Freer páčidlo nosní ostré; 19,0 cm
32	<b>123 91 0009</b>	Cottle páčidlo nosní; 23,0 cm
33	<b>128 12 0120</b>	Dláto na nosní plastiku; 190×10 mm
34	<b>128 12 0130</b>	Dláto na nosní plastiku; 190×12 mm
35	<b>128 12 0160</b>	Dláto na nosní plastiku fig.2; 180×4 mm
36	<b>128 12 0170</b>	Dláto na nosní plastiku fig.2; 180×6 mm
37	<b>128 08 0901</b>	Kladívko chirurgické kovové; 250 g
38	<b>132 91 0097</b>	Mayo-Hegar jehlelec tvrdokov; 16,0 cm
39	<b>38-523-235</b>	Andrew-Pynchon odsávačka; 23,5 cm
40	<b>136 91 0081</b>	Miska; 0,45 l; 12,8×5,5 cm
41	<b>136 91 0082</b>	Miska; 0,70 l; 14,7×6,5 cm
42	<b>136 39 0211</b>	Krabička kulatá; nerez; 65×15 mm
43	<b>136 39 0212</b>	Krabička kulatá perforovaná; nerez; 62×13 mm

**Recommended set for septoplasty**

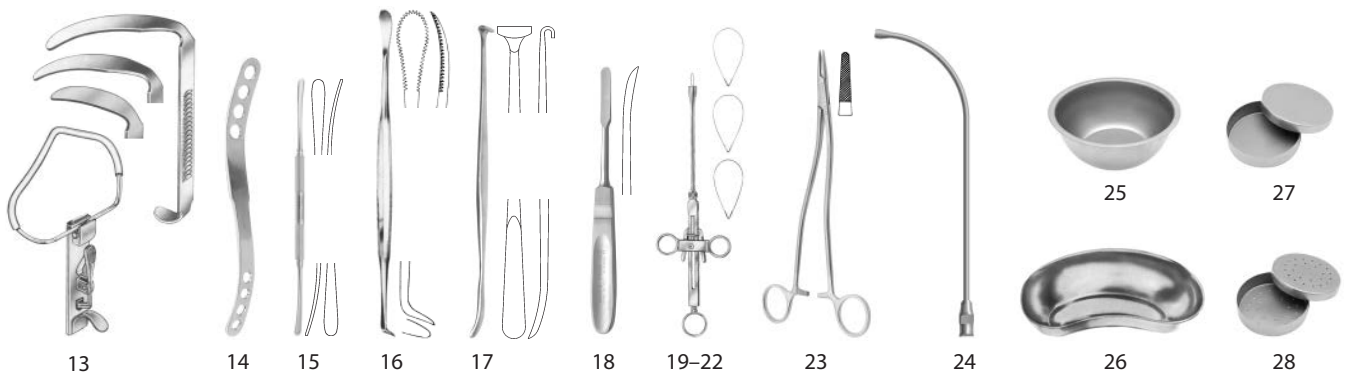
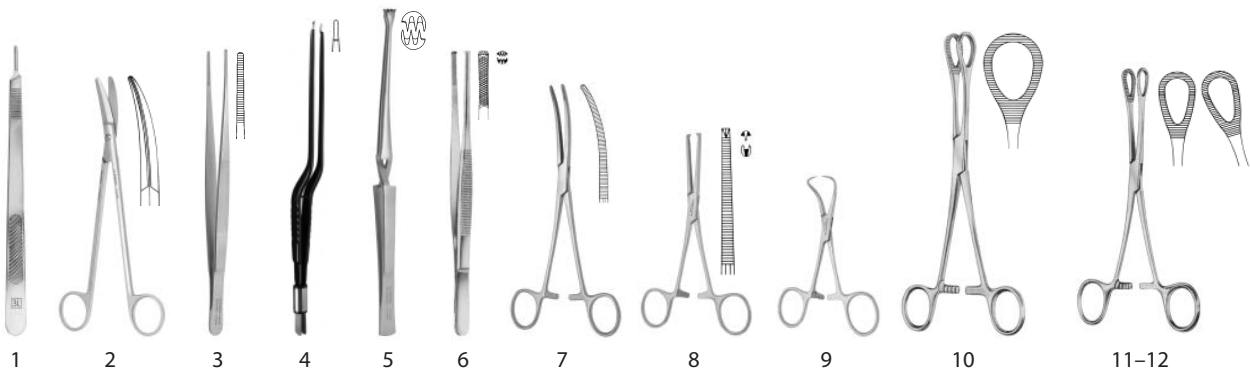
	ks/pcs
Ballenger knife for septum fig.1; 20.0 cm	1
Scalpel handle no.3	1
Rosen needle curved; 16.0 cm	1
Dissecting scissors curved; 12.0 cm	1
Heymann nasal scissors; 18.0 cm	1
Mayo-Stille dissecting scissors curved blunt; 15.0 cm	1
Killian septum scissors; 20.0 cm	1
Tissue forceps very fine; 1×2 teeth; 14.5 cm	1
Graefe eye forceps straight; 1×2 teeth; 10.5 cm	1
Taylor dressing forceps with dissector; 17.5 cm	2
Splinter forceps; 14.0 cm	1
Columella forceps; 11.0 cm	1
Mosquito-Halsted artery forceps curved; 12.0 cm	2
Rochester-Pean artery forceps curved; 14.0 cm	2
Weil-Blakesley nasal cutting forceps; 12.5 cm	1
Weil-Blakesley nasal cutting forceps; 12.5 cm	1
Weil-Blakesley nasal cutting forceps; 12.5 cm	1
Hartmann nasal polypus forceps; 20.0 cm	1
Heywood-Smith forceps; 21.0 cm	1
Cottle cartilage crucher	1
Delicate hook 2 prongs blunt; 16.0 cm	1
Nasal alar hook; 10.5 cm	1
Eye hook 2 prongs sharp; 3.2 mm; 13.5 cm	2
Mayo tongue depressor; 17.0 cm	1
Hartmann nasal speculum fig.1; 15.0 cm	1
Hartmann nasal speculum fig.2; 15.0 cm	1
Hartmann nasal speculum fig.3; 15.0 cm	1
Killian nasal speculum; 35 mm; 13.0 cm	1
Killian nasal speculum; 50 mm; 13.0 cm	1
Killian nasal speculum; 75 mm; 13.0 cm	1
Freer nasal elevator; 19.0 cm	1
Cottle nasal elevator; 23.0 cm	1
Nasal plastic chisel; 190×10 mm	1
Nasal plastic chisel; 190×12 mm	1
Nasal plastic chisel fig.2; 180×4 mm	1
Nasal plastic chisel fig.2; 180×6 mm	1
Mallet metallic; 250 g	1
Mayo-Hegar needle holder TUC; 16.0 cm	1
Andrew-Pynchon suction tube; 23.5 cm	2
Bowl; 0.45 l; 12.8×5.5 cm	2
Bowl; 0.70 l; 14.7×6.5 cm	1
Box round; 65×15 mm	1
Box round perforated; 62×13 mm	1

SET PRO TONSILEKTOMII  
SET FOR TONSILLECTOMY

## Doporučený set pro tonsilektomii

## Recommended set for tonsillectomy

1	<b>112 91 0005</b>	Držátko skalpelových čepelí č.3L	Scalpel handle no.3L	1
2	<b>113 32 0010</b>	Prince nůžky na mandle; 18,5 cm	Prince tonsil scissors; 18.5 cm	1
3	<b>114 08 0140</b>	Pinzeta anatomická jemná; 20,0 cm	Dressing forceps fine; 20.0 cm	2
4	<b>95131</b>	Pinzeta bipolární bajonetová; 1×6 mm; 22,0 cm	Bipolar forceps bay-shaped; 1×6 mm; 22.0 cm	1
5	<b>114 32 0010</b>	Maršík pinzeta na mandle; 22,8 cm	Maršík tonsil forceps; 22.8 cm	1
6	<b>114 91 0181</b>	Stille-Barraya pinzeta chirurgická; 3×4 zuby; 20,0 cm	Stille-Barraya tissue forceps; 3×4 teeth; 20.0 cm	2
7	<b>115 91 0128</b>	Rochester-Pean svorka na cévy zahnutá; 20,0 cm	Rochester-Pean artery forceps curved; 20.0 cm	2
8	<b>115 91 0133</b>	Ochsner-Kocher svorka na cévy rovná; 14,0 cm	Ochsner-Kocher artery forceps straight; 14.0 cm	2
9	<b>115 91 0343</b>	Backhaus svorka na prádlo; 11,0 cm	Backhaus towel forceps; 11.0 cm	2
10	<b>117 91 0038</b>	Heywood-Smith kleště tamponové; 21,0 cm	Heywood-Smith forceps; 21.0 cm	1
11	<b>117 91 0043</b>	Foerster-Ballenger kleště tamponové rovné vroubk.; 20,0 cm	Foerster-Ballenger forceps straight serrated; 20.0 cm	1
12	<b>117 91 0046</b>	Foerster-Ballenger kleště tamponové Zahn. vroubk.; 20,0 cm	Foerster-Ballenger forceps curved serrated; 20.0 cm	1
13	<b>119 91 0222</b>	Mc Ivor rozvěrač úst komplet	Mc Ivor mouth retractor set	1
14	<b>121 31 0020</b>	Bruenings lopatka na jazyk; 14×18 mm; 19,5 cm	Bruenings tongue spatula; 14×18 mm; 19.5 cm	1
15	<b>123 30 0030</b>	Freer páčidlo na nosní přepážku dvojité; 19,5 cm	Freer septum elevator; 19.5 cm	1
16	<b>123 91 0018</b>	Henke páčidlo na mandle; 23,0 cm	Henke dissector; 23.0 cm	1
17	<b>124 32 0010</b>	Hurd škrabka na mandle; 12×8 mm; 21,0 cm	Hurd tonsil raspatory; 12×8 mm; 21.0 cm	1
18	<b>124 30 0020</b>	Přecechtěl škrabka nosní; 19,0 cm	Přecechtěl nasal raspatory; 19.0 cm	1
19	<b>126 91 0001</b>	Bruenings skřípec na mandle; 28,0 cm	Bruenings tonsil snare; 28.0 cm	1
20	<b>126 32 0120</b>	Smyčka drátěná; 0,3 mm; 4,0 cm	Wire loop for tonsil; 0.3 mm; 4.0 cm	1
21	<b>126 32 0130</b>	Smyčka drátěná; 0,4 mm; 4,0 cm	Wire loop for tonsil; 0.4 mm; 4.0 cm	1
22	<b>126 32 0140</b>	Smyčka drátěná; 0,5 mm; 4,0 cm	Wire loop for tonsil; 0.5 mm; 4.0 cm	1
23	<b>132 06 0720</b>	Bozemann jehelec hloubk. prohnutý tvrdokov; 20,0 cm	Needle holder TUC; 20.0 cm	1
24	<b>38-523-235</b>	Andrew-Pynchon odsávačka; 23,5 cm	Andrew-Pynchon suction tube; 23.5 cm	2
25	<b>136 91 0081</b>	Miska; 0,45 l; 12,8×5,5 cm	Bowl; 0.45 l; 12.8×5.5 cm	2
26	<b>136 91 0088</b>	Miska; 25,0 cm	Bowl; 25.0 cm	1
27	<b>136 39 0211</b>	Krabička kulatá; nerez; 65×15 mm	Box round; 65×15 mm	1
28	<b>136 39 0212</b>	Krabička kulatá perforovaná; nerez; 62×13 mm	Box round perforated; 62×13 mm	1

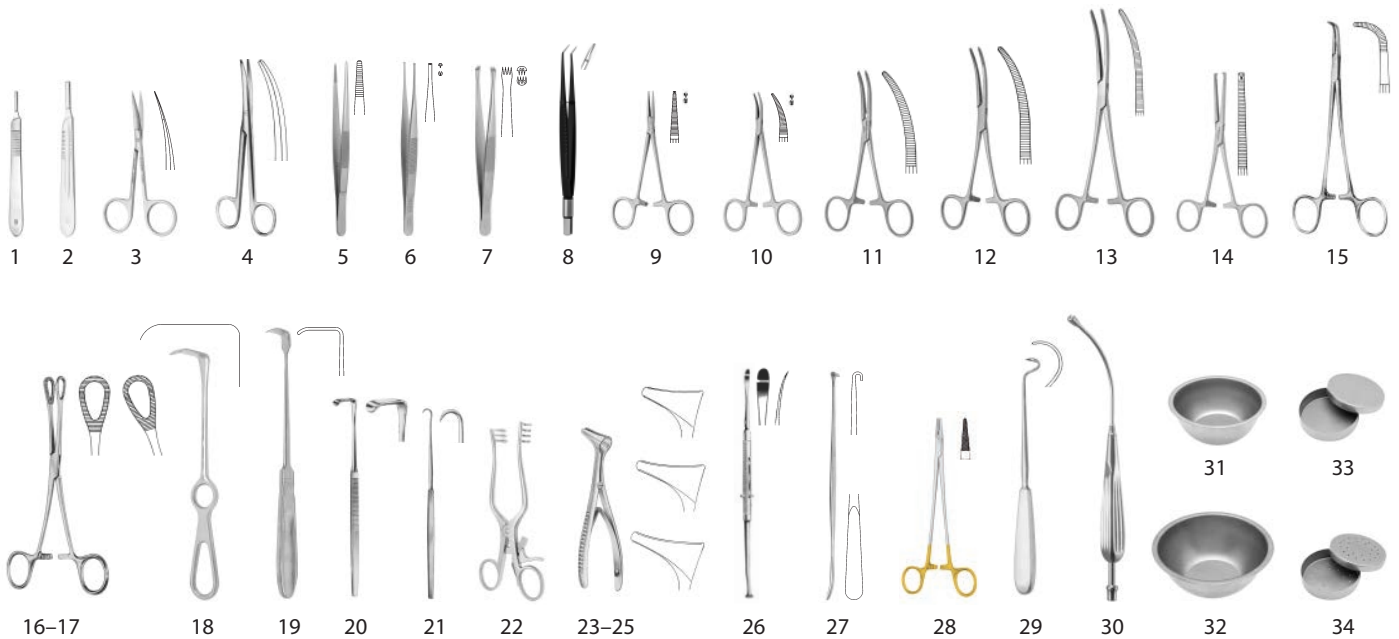
**Doporučený set pro tracheotomii**

1	<b>112 91 0003</b>	Držátko skalpelových čepelků č.3
2	<b>112 91 0004</b>	Držátko skalpelových čepelků č.4
3	<b>113 12 0020</b>	Nůžky preparační s oboustranným ostřím zahnuté; 12,0 cm
4	<b>113 91 0101</b>	Mayo-Stillé nůžky preparační tupé zahnuté; 15,0 cm
5	<b>114 08 0101</b>	Pinzeta anatomická jemná; 14,5 cm
6	<b>114 08 0530</b>	Pinzeta chirurgická velmi jemná; 1×2 zuby; 14,5 cm
7	<b>114 08 0620</b>	Pinzeta chirurgická; 3×4 zuby; 14,0 cm
8	<b>95013</b>	Pinzeta bipolární zahnutá; 0,5×8 mm; 16,0 cm
9	<b>115 08 1030</b>	Mosquito-Halsted svorka rovná jemná; 1×2 zuby; 12,0 cm
10	<b>115 08 1050</b>	Mosquito-Halsted svorka zahnutá jemná; 1×2 zuby; 12,0 cm
11	<b>115 91 0125</b>	Rochester-Pean svorka na cévy zahnutá; 14,0 cm
12	<b>115 91 0126</b>	Rochester-Pean svorka na cévy zahnutá; 16,0 cm
13	<b>115 91 0128</b>	Rochester-Pean svorka na cévy zahnutá; 20,0 cm
14	<b>115 91 0133</b>	Ochsner-Kocher svorka na cévy rovná; 14,0 cm
15	<b>115 91 0181</b>	Baby-Adson svorka na cévy zahnutá; 18,0 cm
16	<b>117 91 0042</b>	Foerster-Ballenger kleště tamponové rovné vroubk.; 18,0 cm
17	<b>117 91 0045</b>	Foerster-Ballenger kleště tamponové zah. vroubk.; 18,0 cm
18	<b>118 08 0810</b>	Langenbeck hák na rány; 40×11 mm; 21,0 cm
19	<b>118 34 0020</b>	Hák tracheální plochý; 19×11 mm; 23,5 cm
20	<b>118 91 0069</b>	Mini-Langenbeck hák jemný; 10×6 mm; 16,0 cm
21	<b>118 91 0320</b>	Iterson hák na průdušnici fig.1; 16,0 cm
22	<b>119 08 1060</b>	Weitlaner rozvěrač ran tupý; 3×4 zuby; 14,0 cm
23	<b>122 91 0302</b>	Hartmann zrcátko nosní fig.1; 15,0 cm
24	<b>122 91 0304</b>	Hartmann zrcátko nosní fig.2; 15,0 cm
25	<b>122 91 0306</b>	Hartmann zrcátko nosní fig.3; 15,0 cm
26	<b>123 91 0006</b>	Freer páčidlo nosní ostré; 19,0 cm
27	<b>124 32 0010</b>	Hurd škrabka na mandle; 12×8 mm; 21,0 cm
28	<b>132 91 0140</b>	Baby-Crile-Wood jehelec tvrdokov; 15,0 cm
29	<b>132 91 0309</b>	Deschamps jehla podvazovací ostrá malá levá; 20,0 cm
30	<b>38-523-235</b>	Andrew-Pynchon odsávačka; 23,5 cm
31	<b>136 91 0081</b>	Miska; 0,45 l; 12,8×5,5 cm
32	<b>136 91 0082</b>	Miska; 0,70 l; 14,7×6,5 cm
33	<b>136 39 0211</b>	Krabička kulatá; nerez; 65×15 mm
34	<b>136 39 0212</b>	Krabička kulatá perforovaná; nerez; 62×13 mm

**Recommended set for tracheotomy**

	ks/pcs
Scalpel handle no.3	1
Scalpel handle no.4	1
Dissecting scissors curved; 12.0 cm	2
Mayo-Stillé dissecting scissors curved blunt; 15.0 cm	1
Dressing forceps fine; 14.5 cm	1
Tissue forceps very fine; 1×2 teeth; 14.5 cm	3
Tissue forceps; 3×4 teeth; 14.0 cm	1
Bipolar forceps bent; 0.5×8 mm; 16.0 cm	1
Mosquito-Halsted artery forceps straight; 1×2 teeth; 12.0 cm	2
Mosquito-Halsted artery forceps curved; 1×2 teeth; 12.0 cm	5
Rochester-Pean artery forceps curved; 14.0 cm	7
Rochester-Pean artery forceps curved; 16.0 cm	3
Rochester-Pean artery forceps curved; 20.0 cm	3
Ochsner-Kocher artery forceps straight; 14.0 cm	2
Baby-Adson artery forceps curved; 18.0 cm	1
Foerster-Ballenger forceps straight serrated; 18.0 cm	1
Foerster-Ballenger forceps curved serrated; 18.0 cm	1
Langenbeck retractor; 40×11 mm; 21.0 cm	2
Tracheal hook; 19×11 mm; 23.5 cm	2
Mini-Langenbeck retractor; 10×6 mm; 16.0 cm	2
Iterson trachea retractor fig.1; 16.0 cm	1
Weitlaner retractor 3×4 teeth blunt; 14.0 cm	2
Hartmann nasal speculum fig.1; 15.0 cm	1
Hartmann nasal speculum fig.2; 15.0 cm	1
Hartmann nasal speculum fig.3; 15.0 cm	1
Freer nasal elevator; 19.0 cm	1
Hurd tonsil raspatory; 12×8 mm; 21.0 cm	1
Baby-Crile-Wood needle holder TUC; 15.0 cm	2
Deschamps ligature needle pointed small left; 20.0 cm	1
Andrew-Pynchon suction tube; 23.5 cm	1
Bowl; 0.45 l; 12.8×5.5 cm	1
Bowl; 0.70 l; 14.7×6.5 cm	1
Box round; 65×15 mm	1
Box round perforated; 62×13 mm	1



A collection of various gynecological instruments, including forceps, speculums, and retractors, arranged on a white background. A light blue horizontal band is overlaid across the middle of the image, containing the title text.

**NÁSTROJE PRO GYNEKOLOGII**  
**INSTRUMENTS FOR GYNAECOLOGY**





MEDIN, a.s.  
Vlachovická 619  
Nové Město na Moravě  
CZ 592 31  
Czech Republic  
IČO: 43378030  
DIČ: CZ43378030

**CENTRÁLA**  
tel.: 566 684 111

**PRODEJ ČESKÁ REPUBLIKA**  
tel.: 566 684 327  
fax: 566 684 384  
e-mail: prodej@medin.cz

**EXPORT**  
phone: +420 566 684 250  
fax: +420 566 684 385  
e-mail: export@medin.cz

**[www.medin.cz](http://www.medin.cz)**

MEDIN Slovensko, s.r.o.  
Mlynská 10  
Piešťany  
SK 921 01  
Slovak Republic  
IČO: 46540873  
SK DPH: SK2023412688

tel.: +421 337 746 259  
fax: +421 337 746 153  
e-mail: jana.snajdarova@medin.sk

**[www.medin.sk](http://www.medin.sk)**

<b>397 111</b>	<b>Diagnostika</b>	Diagnostic	441
<b>397 112</b>	<b>Nástroje řezné</b>	Cutting Instruments	442
<b>397 113</b>	<b>Nůžky</b>	Scissors	443–444
<b>397 115</b>	<b>Svorky</b>	Clamp, Forceps	445–447
<b>397 116</b>	<b>Kleště štípací</b>	Biopsy Rongeurs	448–455
<b>397 117</b>	<b>Kleště úchopné</b>	Grasping Forceps	456–465
<b>397 118</b>	<b>Háky</b>	Hooks, Retractors	466–467
<b>397 122</b>	<b>Zrcadla</b>	Specula	468–479
<b>397 125</b>	<b>Lžičky</b>	Spoons	480–481
<b>397 126</b>	<b>Kyrety</b>	Curettes	482–490
<b>397 133</b>	<b>Pátradla</b>	Probes	491–492
<b>397 135</b>	<b>Dilatátory</b>	Dilators	493
<b>397 136</b>	<b>Nástroje speciální</b>	Special Instruments	494–495

**POZNÁMKA:**

Katalogová čísla MEDIN jsou v katalogu uvedena ve zkrácené podobě bez předčísí pro zdravotnické prostředky.

Například: katalogové číslo / objednáací číslo  
          XXX XX XXXX / 397XXXXXXXXX

Aktuální konverzní tabulku nebo ceník s kompletními objednáacími čísly si vyžádejte u svého obchodního zástupce.

**NOTE:**

MEDIN catalogue numbers in this catalogue are listed in short form without the prefix for medical devices.

For example: catalogue number / order number  
              XXX XX XXXX / 397XXXXXXXXX

Ask your sales representative for the up-to-date conversion table or the price list with complete ordering numbers.

© 2018 MEDIN, a.s.; Všechna práva vyhrazena.

Dokument je určen pro obchodní účely MEDIN, a.s., údaje zde uvedené jsou informativního charakteru.

Žádná část tohoto dokumentu nesmí být reprodukována nebo publikována v jakékoliv formě bez předchozího souhlasu MEDIN, a.s. Zobrazení produktů odpovídá aktuálnímu stavu v době vydání tohoto dokumentu. Změny technických parametrů z důvodu dalšího vývoje jsou vyhrazeny.

Tiskové a typografické chyby jsou vyhrazeny.

© 2018 MEDIN, a.s.; All rights reserved.

This document should be used for commercial purposes of MEDIN, a.s.; the data mentioned in the document has informative character. No part of this document can be copied or published in any form without approval of MEDIN, a.s.

The product design may differ from those depicted in these illustrations at the date of issue. Adjustments, made from the reason of further developments of technical parameters, are reserved.

Printing and typographical errors are reserved.





**SCHULTZE**  
Salpingograf  
Salpingograph  
**62-980-000**  
komplet v dřevěné krabičce  
complete in wooden case



**62-980-001**  
pouze manometr  
manometer only

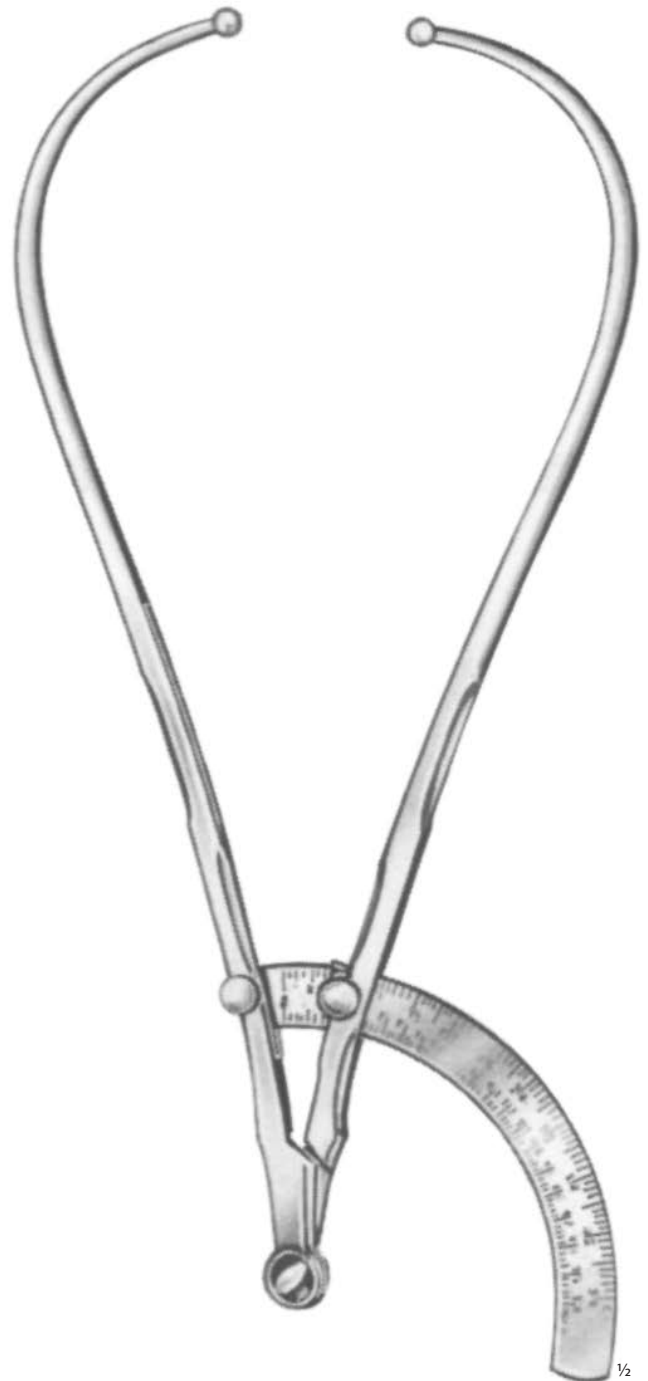

**MARTIN**  
Pelvimetr  
Pelvimeter  
**111 91 0093**  
34,0 cm

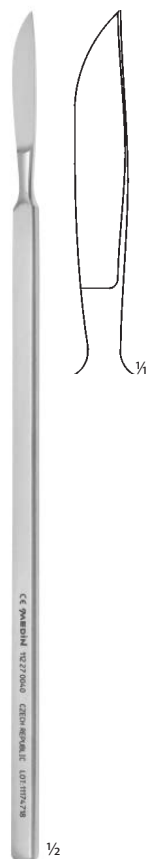

**112 27 0040**  
22,0 cm



**112 27 0050**  
21,5 cm



**112 27 0060**  
21,0 cm



**SECOND**  
**02-799-270**  
27,0 cm

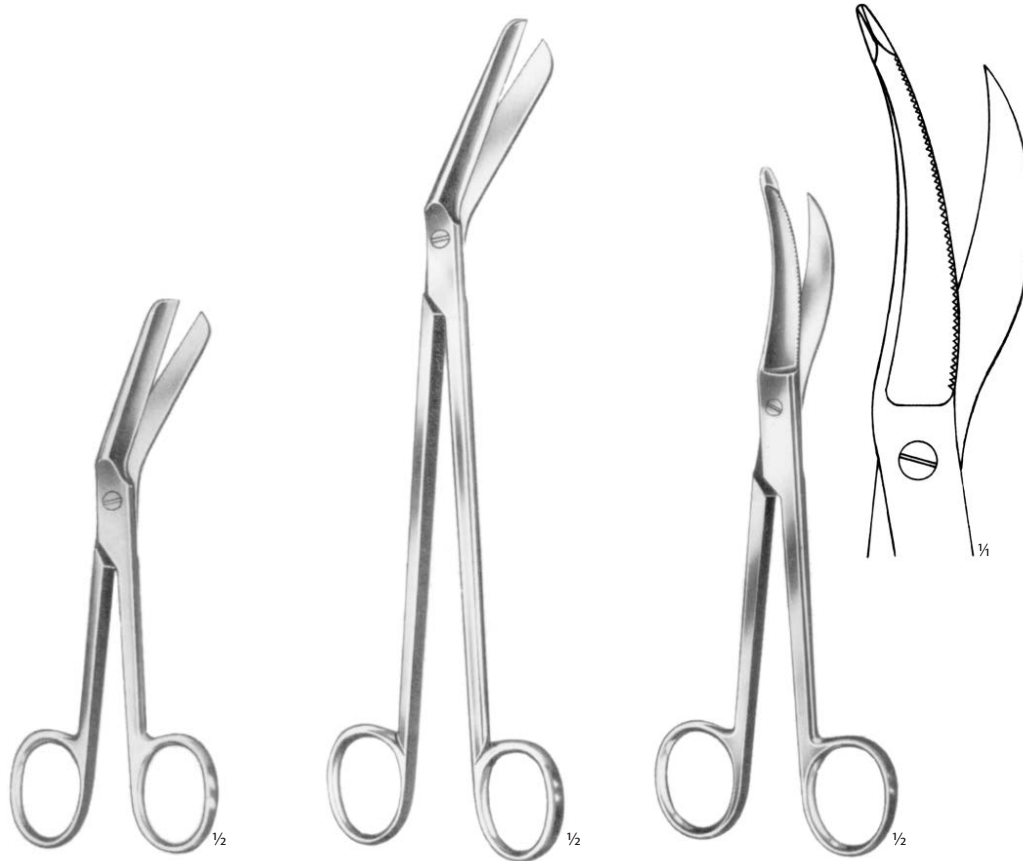

**BRAUN-STADLER**  
**113 91 0317**  
14,0 cm

**BRAUN-STADLER**  
**113 91 0318**  
22,0 cm

**WALDMANN**  
**113 91 0319**  
18,0 cm



**KELLY**  
**113 91 0110**  
rovné  
straight  
16,0 cm

**KELLY**  
**113 91 0112**  
zahnuté  
curved  
16,0 cm



**SIMS**  
**113 91 0121** 20,0 cm **113 91 0125**  
**113 91 0122** 23,0 cm **113 91 0126**



1/2



1/2

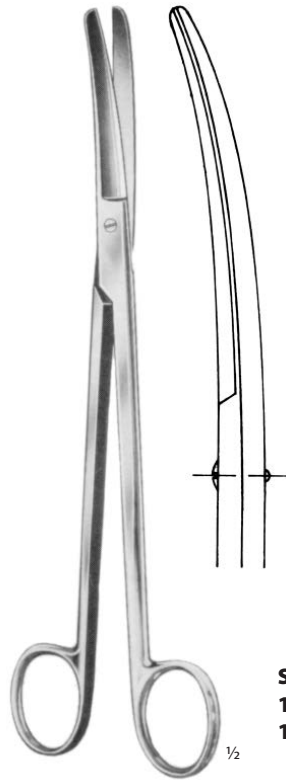

**SIMS**  
**113 91 0123** 20,0 cm **113 91 0127**  
**113 91 0124** 23,0 cm **113 91 0128**



1/2



1/2

**SIMS**  
**113 91 0117** 20,0 cm  
**113 91 0118** 23,0 cm

1/2

**SIMS**  
**113 91 0119** 20,0 cm  
**113 91 0120** 23,0 cm

1/2



**DUBOIS**  
**113 91 0129**  
 27,0 cm

1/2

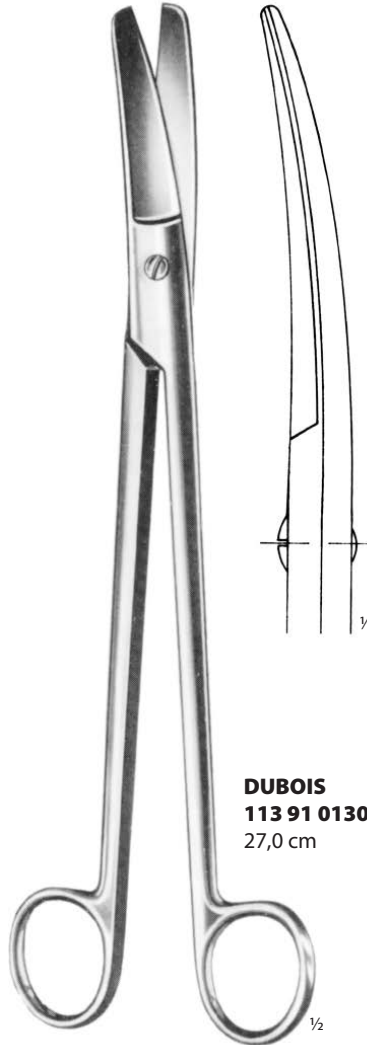

**DUBOIS**  
**113 91 0130**  
 27,0 cm

1/2

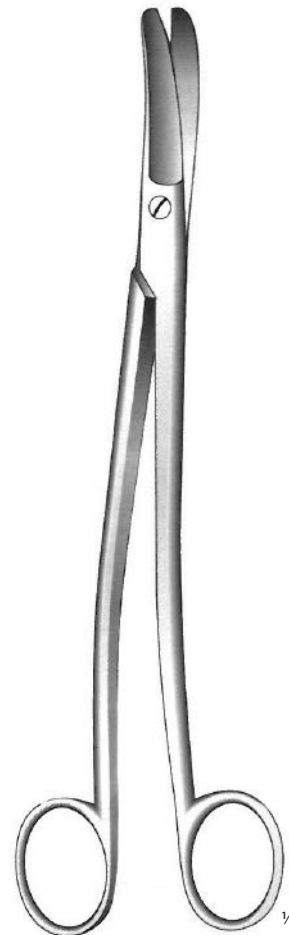

**SIEBOLD**  
**113 27 0010**  
 24,0 cm

1/2

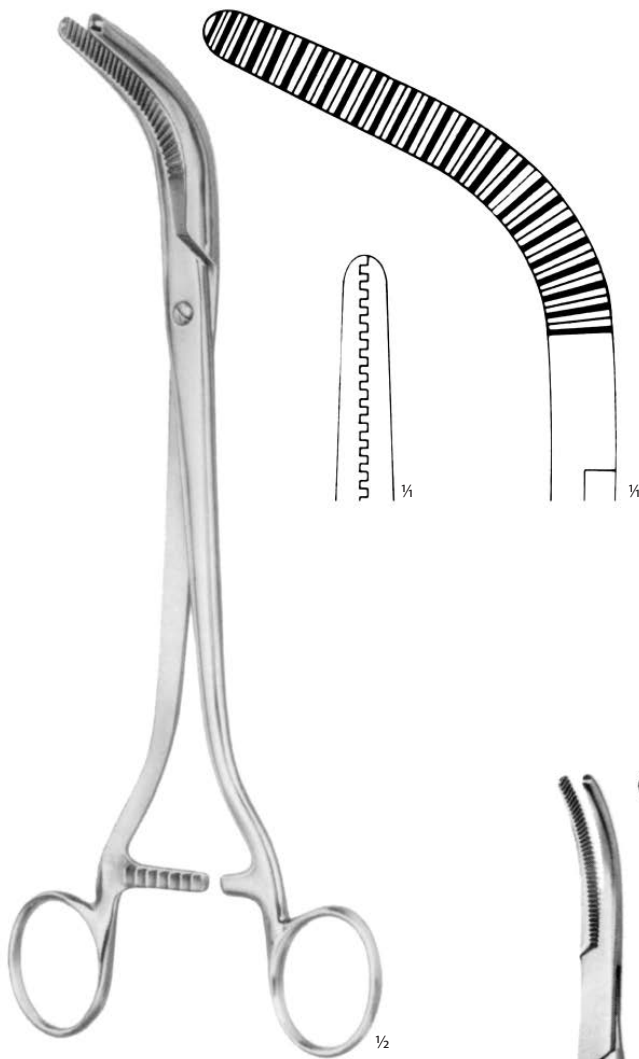

**WERTHEIM**  
**115 91 0281**  
27,0 cm

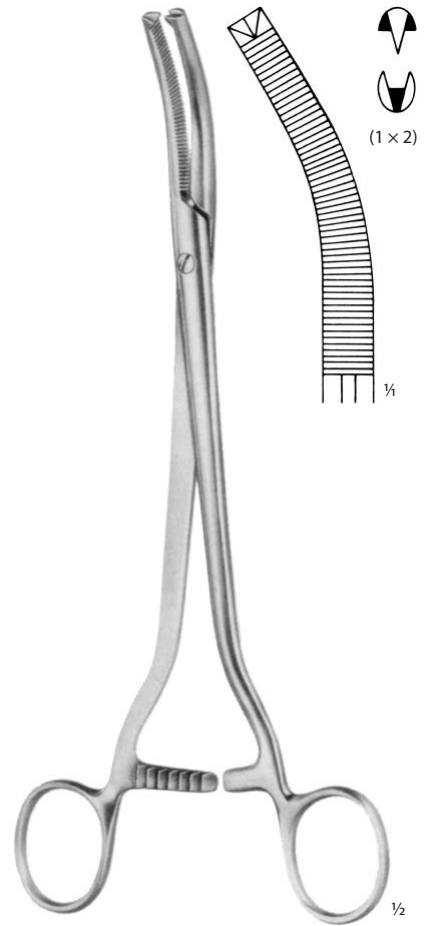

**WERTHEIM**  
**115 91 0282**  
24,0 cm

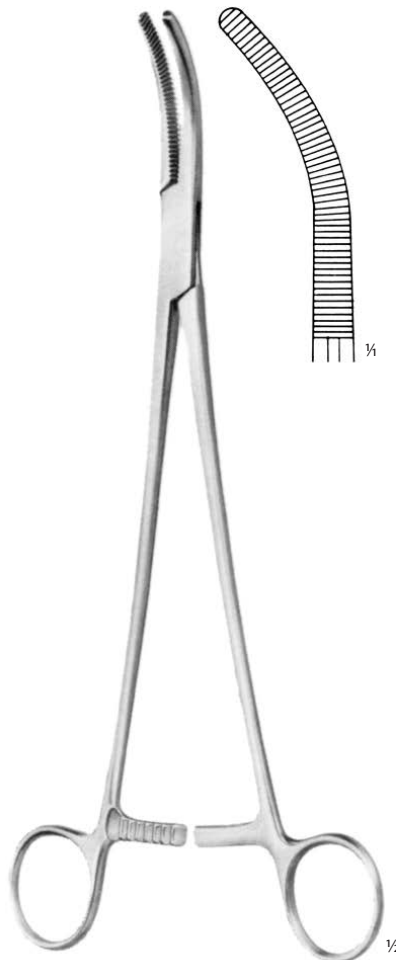

**WERTHEIM**  
**115 91 0283**  
25,0 cm

SVORKY NA HYSTEREKTOMII  
HYSTERECTOMY CLAMP-FORCEPS

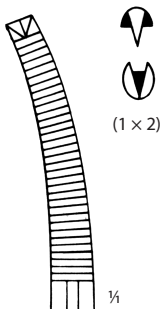

**115 91 0284**  
lehce zahnuté  
slightly curved

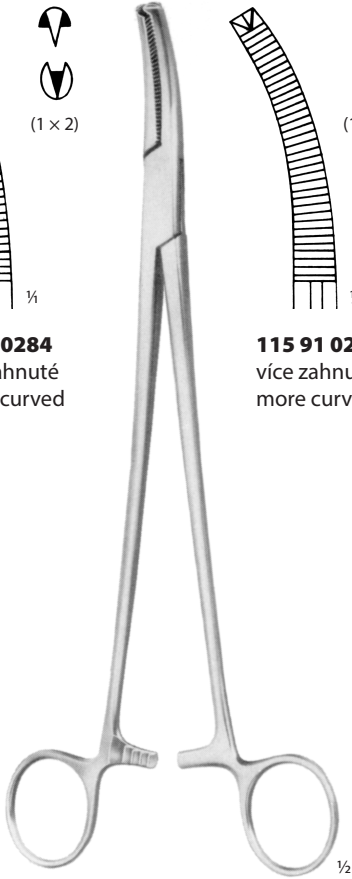

**WERTHEIM**  
23,0 cm

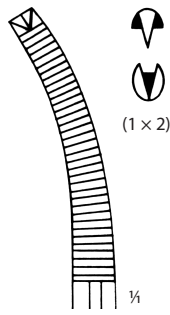

**115 91 0285**  
více zahnuté  
more curved

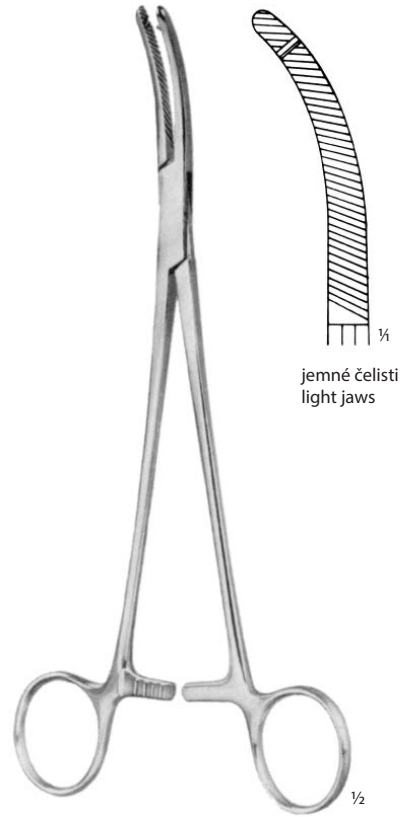

**HEANEY**  
**115 91 0286**  
21,0 cm

jemné čelisti  
light jaws

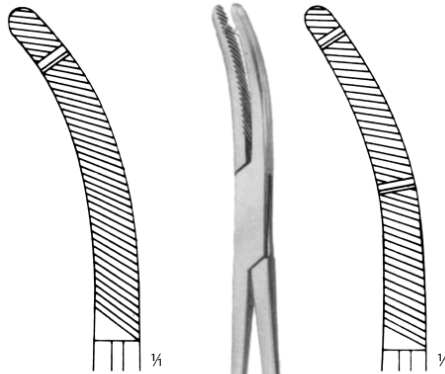

Original 21,0 cm

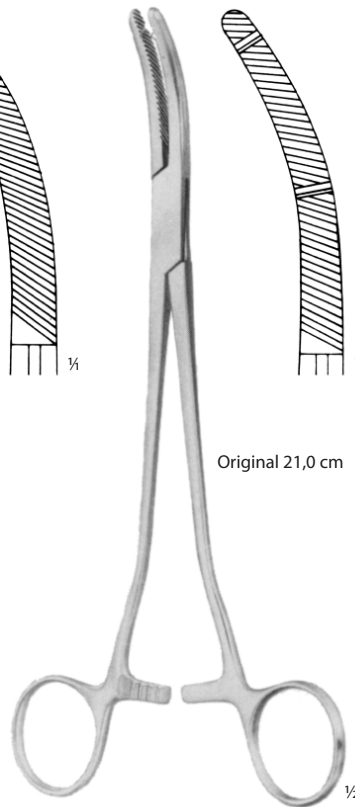

**HEANEY**  
**115 91 0287** 21,0 cm    **115 91 0289**  
**115 91 0288** 23,0 cm    **115 91 0290**

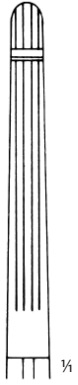

115 91 0291

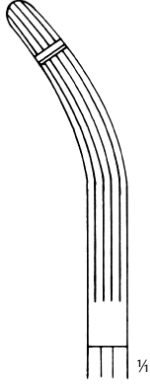

115 91 0292

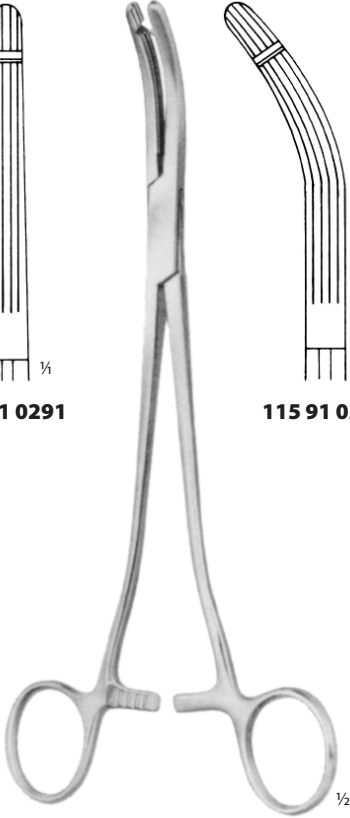

**HEANEY-BALANTINE**  
21,0 cm

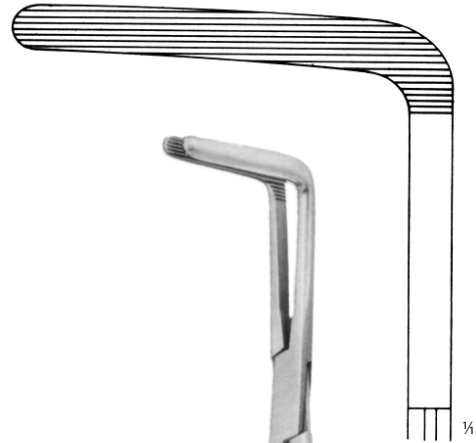

**WERTHEIM-CULLEN**  
115 91 0299  
21,5 cm

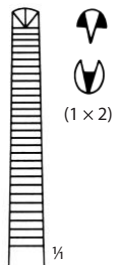

115 91 0300



(1 × 2)

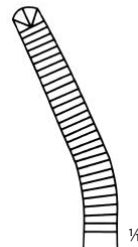

115 91 0301

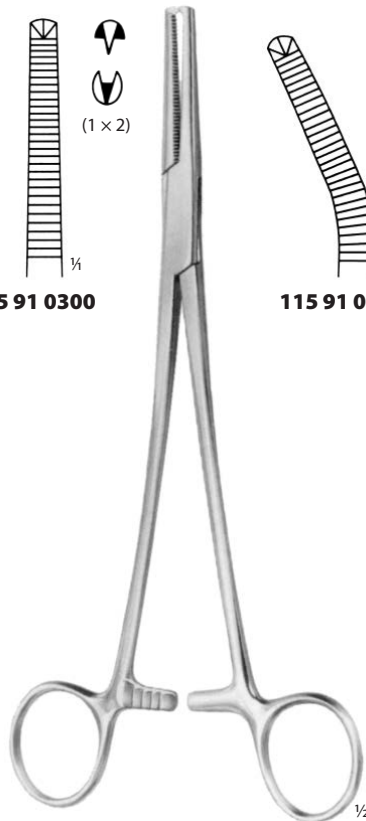

**PHANEUF**  
21,5 cm

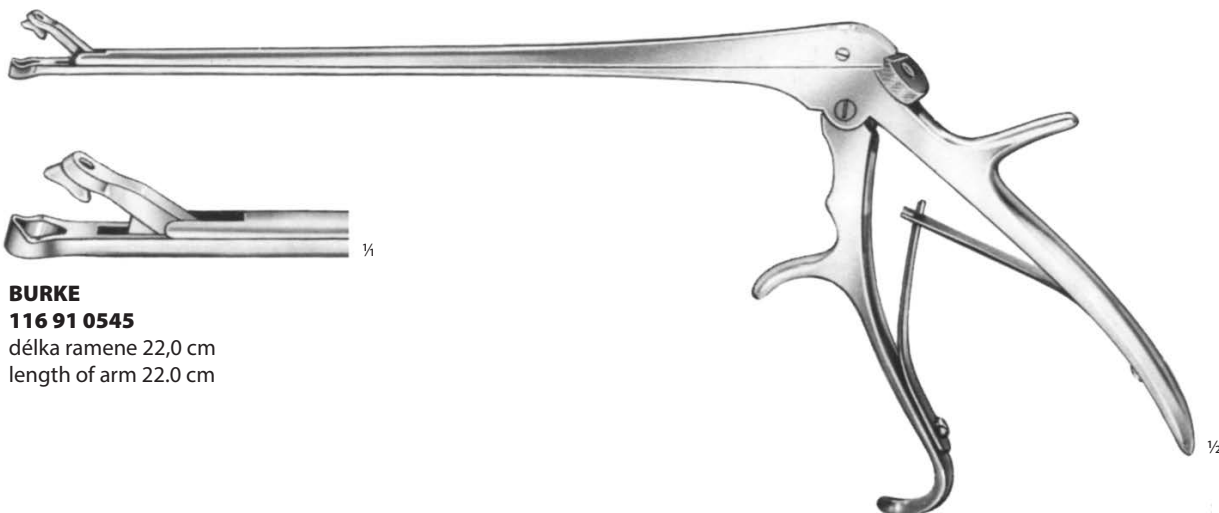
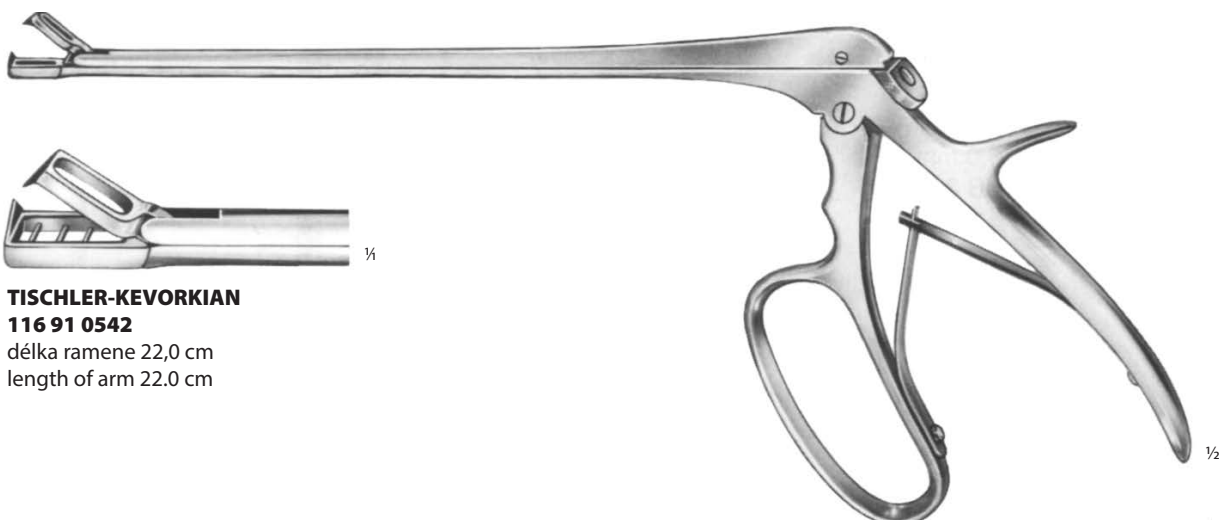
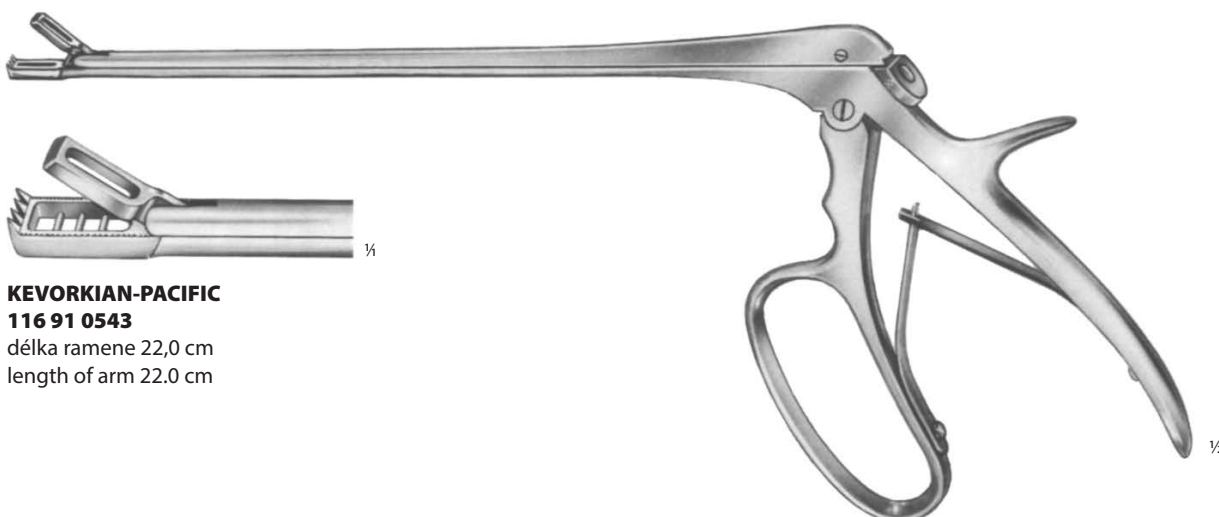
KLEŠTĚ NA BIOPSI  
CERVICAL BIOPSY FORCEPS**BURKE****116 91 0545**délka ramene 22,0 cm  
length of arm 22.0 cm**TISCHLER-KEVORKIAN****116 91 0542**délka ramene 22,0 cm  
length of arm 22.0 cm**KEVORKIAN-PACIFIC****116 91 0543**délka ramene 22,0 cm  
length of arm 22.0 cm



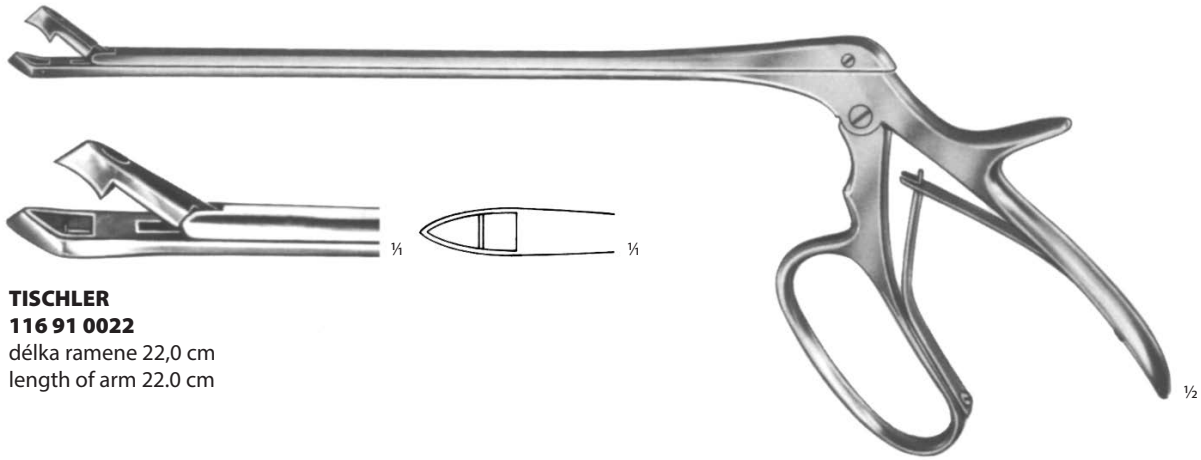

**TISCHLER**  
**116 91 0022**  
délka ramene 22,0 cm  
length of arm 22.0 cm

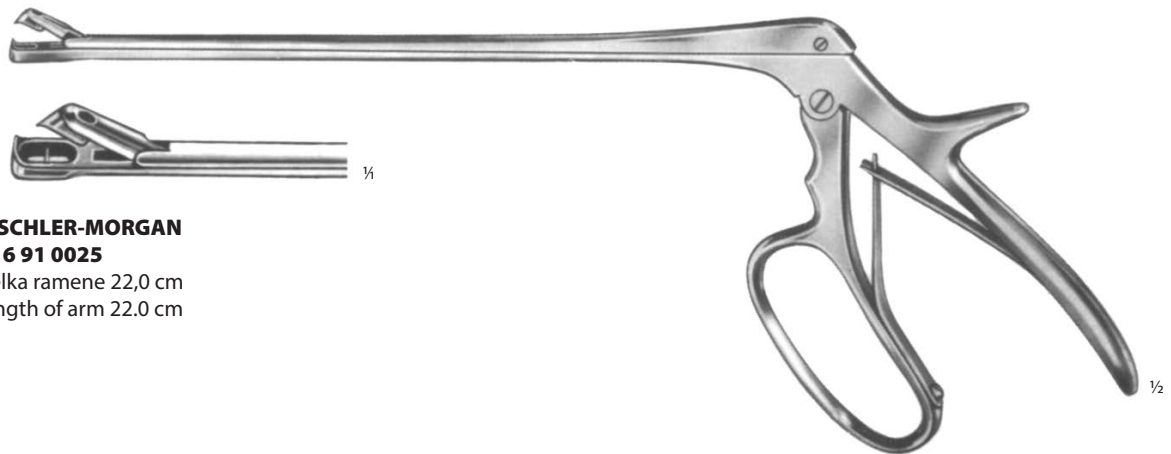

**TISCHLER-MORGAN**  
**116 91 0025**  
délka ramene 22,0 cm  
length of arm 22.0 cm

KLEŠTĚ NA BIOPSII DĚTSKÉ  
CERVICAL BIOPSY FORCEPS FOR CHILDREN

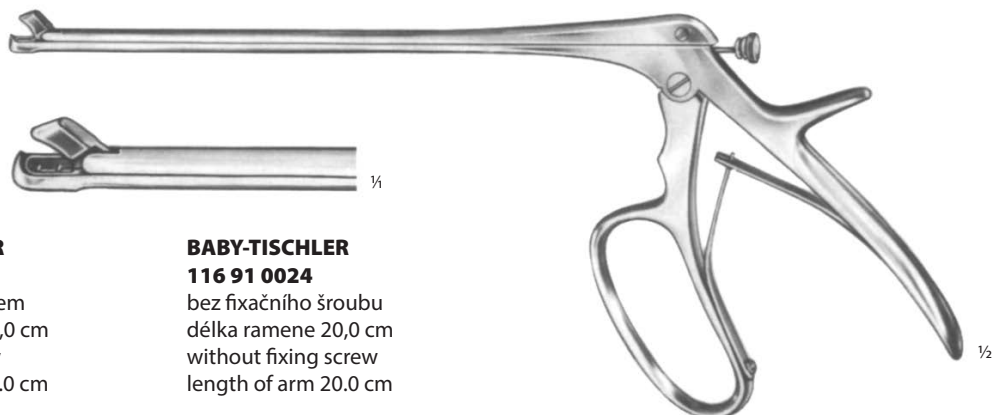

**BABY-TISCHLER**  
**116 91 0544**  
s fixačním šroubem  
délka ramene 20,0 cm  
with fixing screw  
length of arm 20.0 cm

**BABY-TISCHLER**  
**116 91 0024**  
bez fixačního šroubu  
délka ramene 20,0 cm  
without fixing screw  
length of arm 20.0 cm



**GELLHORN**  
**116 91 0026**  
23,0 cm



**FAURE**  
**116 91 0027**  
23,0 cm



**SCHUBERT**  
**116 91 0028** 21,0 cm  
**116 91 0029** 29,0 cm



**THOMS-GAYLOR**  
**116 91 0030**  
24,0 cm



**SCHUBERT**  
**116 91 0031**  
26,0 cm



**TISCHLER**  
**116 91 0032**  
27,0 cm



**116 91 0033**  
5 mm  
Fig. 1



**SCHUMACHER-VAN DOREN**  
24,0 cm



**116 91 0034**  
7 mm  
Fig. 2



**VAN DOREN**  
**116 91 0035**  
25,0 cm

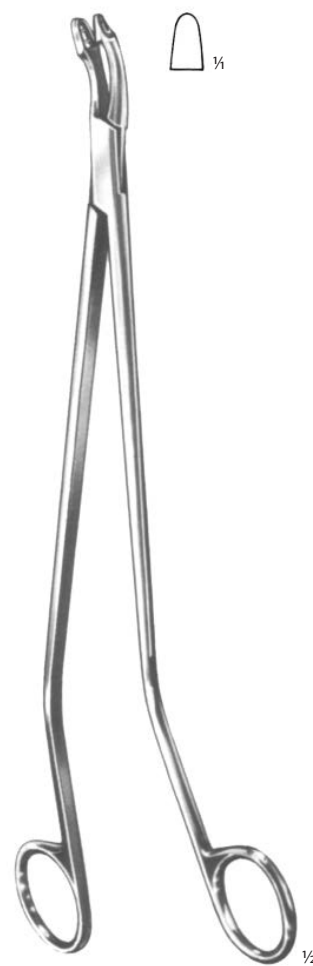

**VAN DOREN**  
**116 91 0036**  
25,0 cm

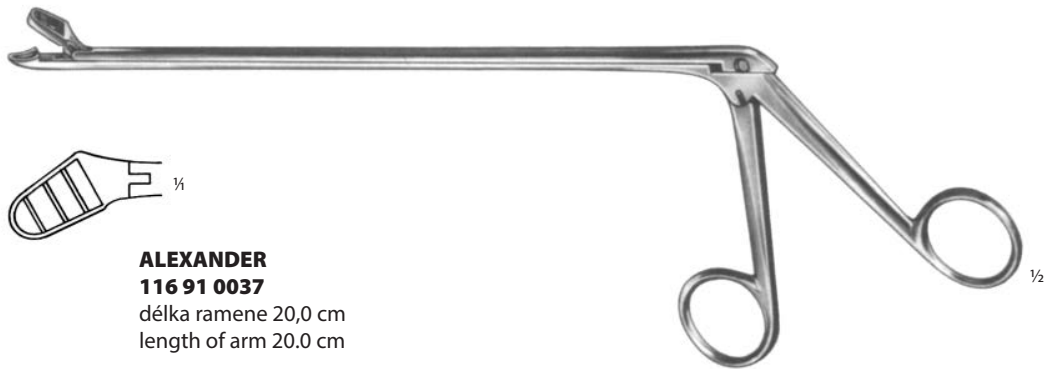

**ALEXANDER**  
**116 91 0037**  
délka ramene 20,0 cm  
length of arm 20.0 cm

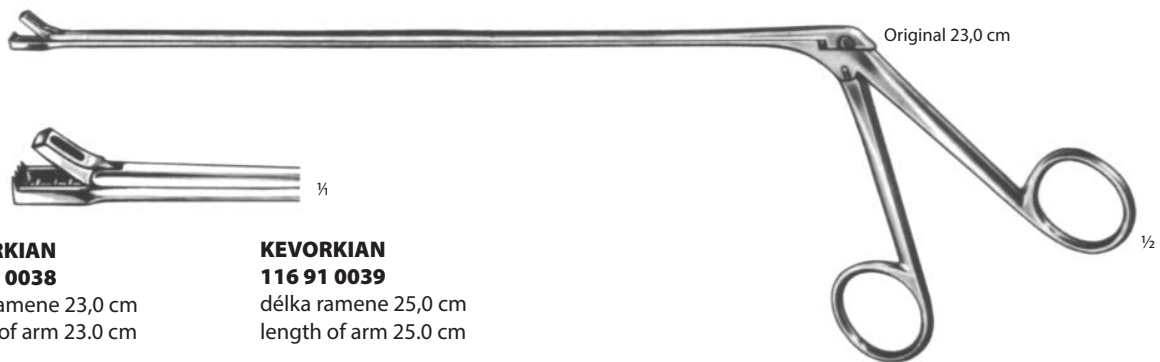

**KEVORKIAN**  
**116 91 0038**  
délka ramene 23,0 cm  
length of arm 23.0 cm

**KEVORKIAN**  
**116 91 0039**  
délka ramene 25,0 cm  
length of arm 25.0 cm

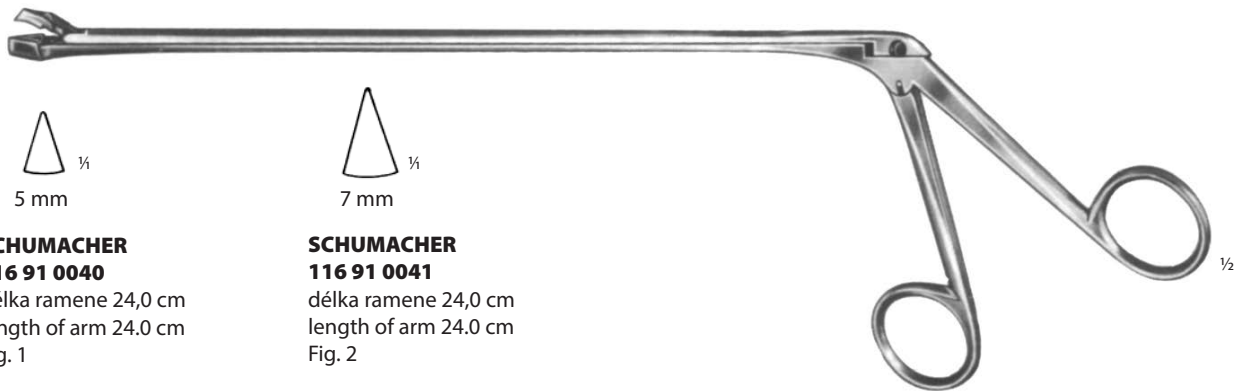

**SCHUMACHER**  
**116 91 0040**  
délka ramene 24,0 cm  
length of arm 24.0 cm  
Fig. 1

**SCHUMACHER**  
**116 91 0041**  
délka ramene 24,0 cm  
length of arm 24.0 cm  
Fig. 2

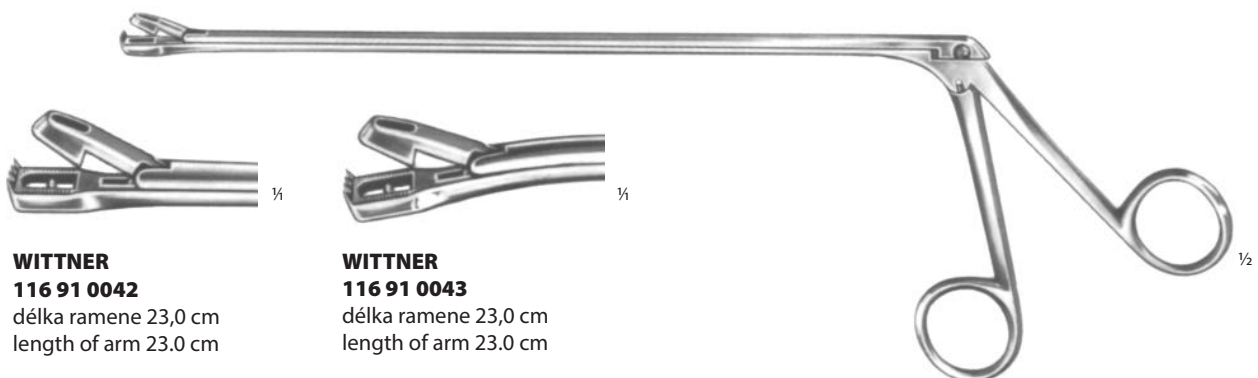

**WITTNER**  
**116 91 0042**  
délka ramene 23,0 cm  
length of arm 23.0 cm

**WITTNER**  
**116 91 0043**  
délka ramene 23,0 cm  
length of arm 23.0 cm

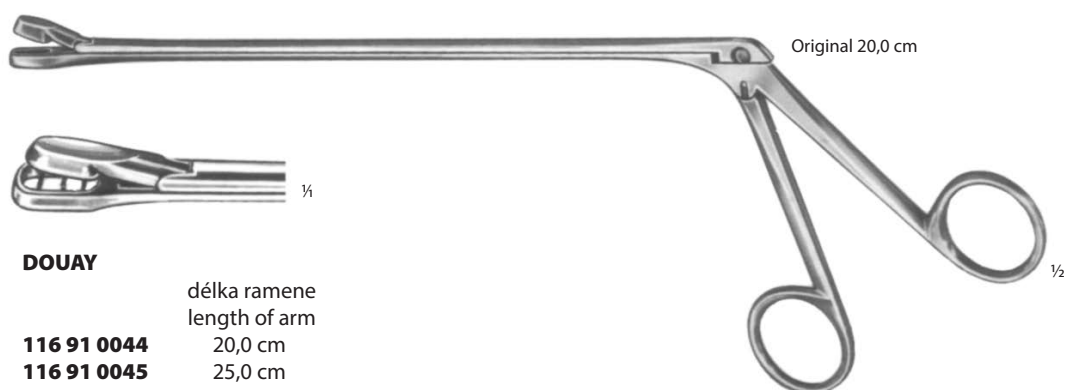
KLEŠTĚ NA BIOPSII  
CERVICAL BIOPSY FORCEPS**EPPENDORF**  
**116 91 0054**délka ramene 20,0 cm  
length of arm 20.0 cm**EPPENDORF**  
**116 91 0055**délka ramene 23,0 cm  
length of arm 23.0 cm**BERGER**  
**116 91 0546**délka ramene 20,5 cm  
length of arm 20.5 cm**DOUAY**

	délka ramene length of arm
<b>116 91 0044</b>	20,0 cm
<b>116 91 0045</b>	25,0 cm
<b>116 91 0046</b>	30,0 cm
<b>116 91 0047</b>	35,0 cm
<b>116 91 0048</b>	40,0 cm



**TISCHLER**  
**116 91 0050**  
délka ramene 25,0 cm  
length of arm 25.0 cm



**KEVORKIAN**  
**116 91 0051**  
délka ramene 25,0 cm  
length of arm 25.0 cm



**EPPENDORF**  
**116 91 0052**  
délka ramene 25,0 cm  
length of arm 25.0 cm



**MINI-TOWNSEND**  
**116 91 0053**  
délka ramene 25,0 cm  
length of arm 25.0 cm



**TISCHLER**  
držadlo  
handle  
**116 91 0049**

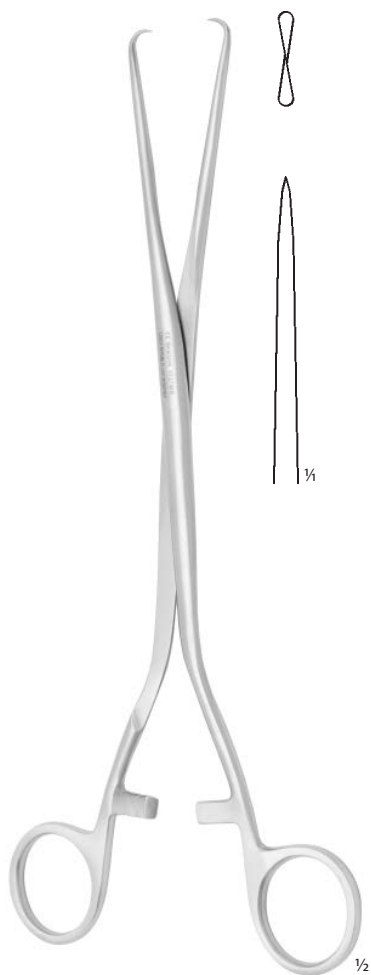

**SCHRÖDER**  
**117 27 0010**  
25,0 cm

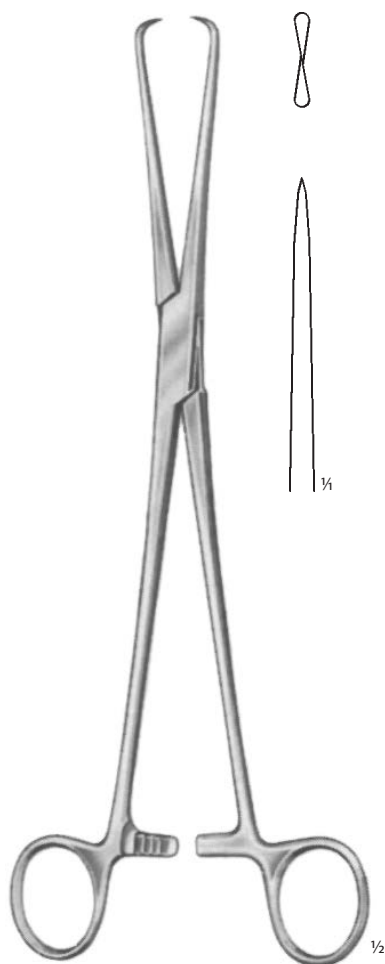

**POZZI**  
**117 91 0201**  
25,0 cm

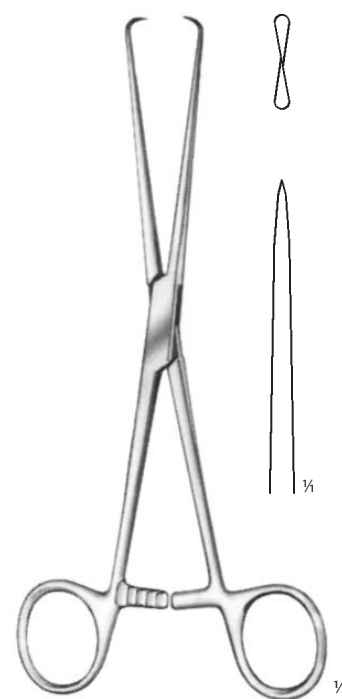

**BARRETT**  
**117 91 0202**  
18,0 cm



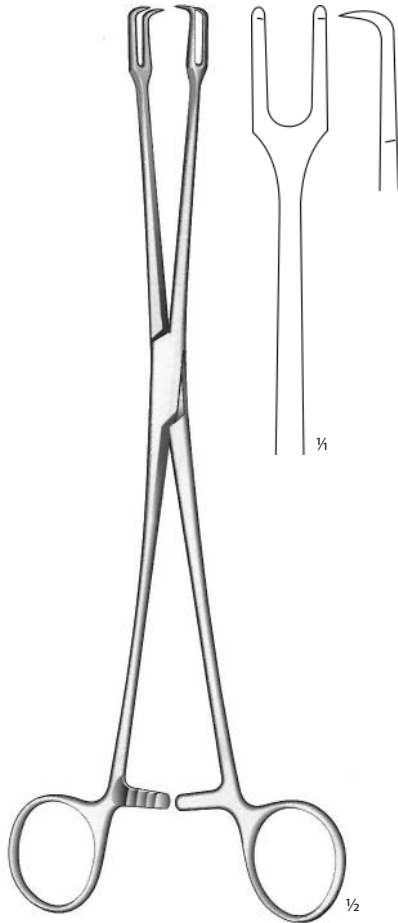

**SCHRÖDER**  
**117 27 0020**  
24,0 cm

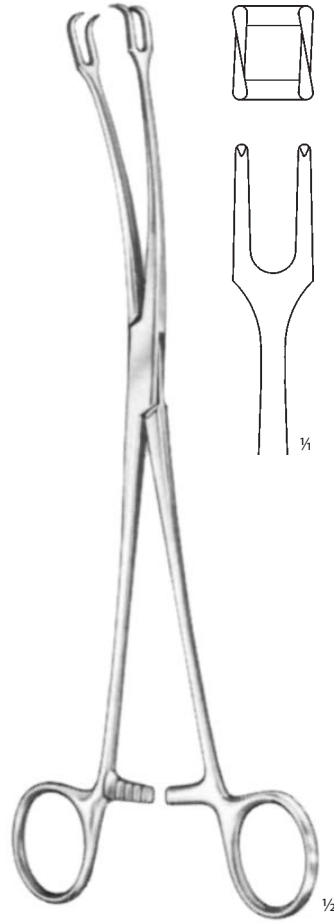

**SCHRÖDER**  
**117 91 0210**  
24,0 cm

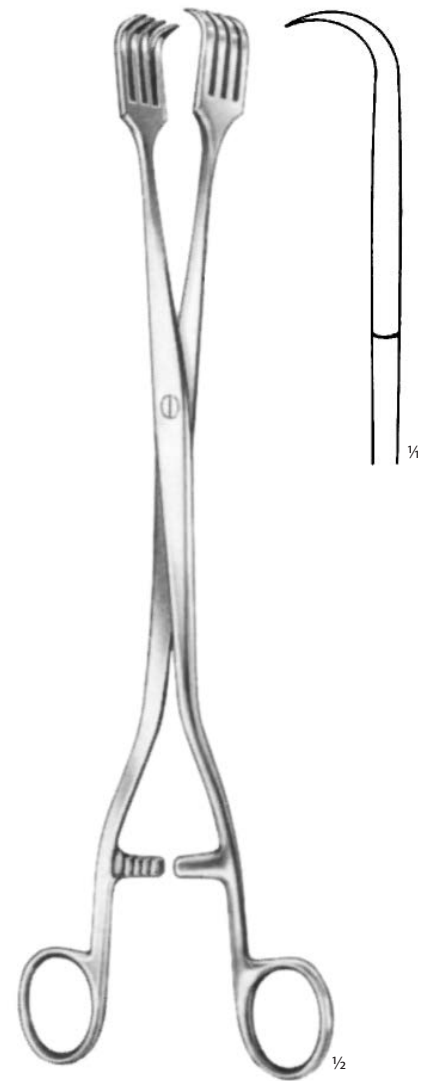

**PRATT**  
**117 91 0211**  
28,0 cm

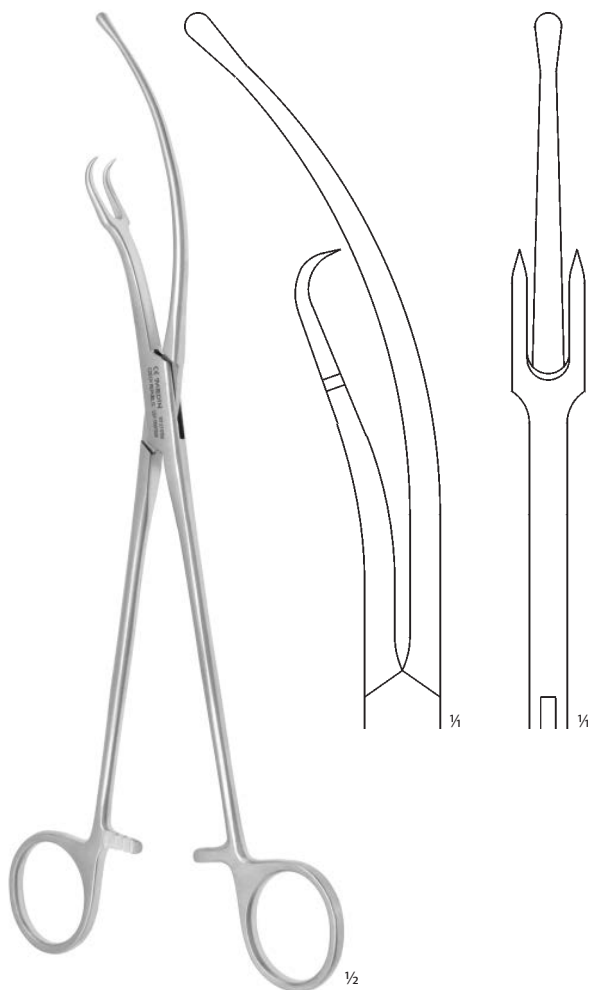

**KEPÁK**  
**117 27 0150**  
26,0 cm



**SAIRGES**  
**117 91 0203**  
23,0 cm

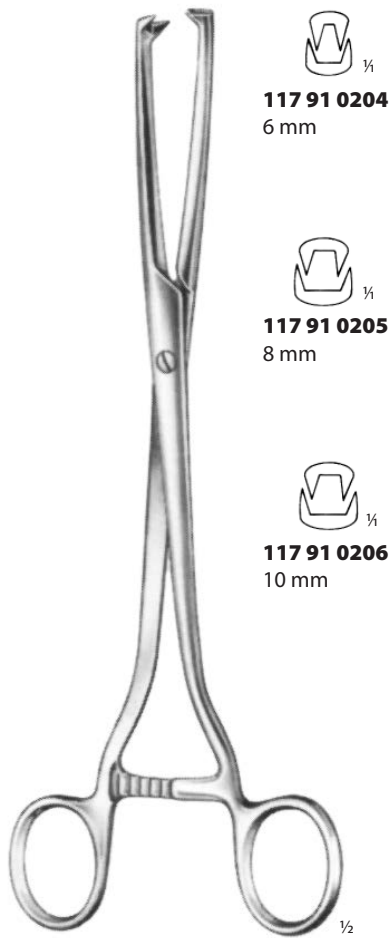

 ¼  
**117 91 0204**  
6 mm

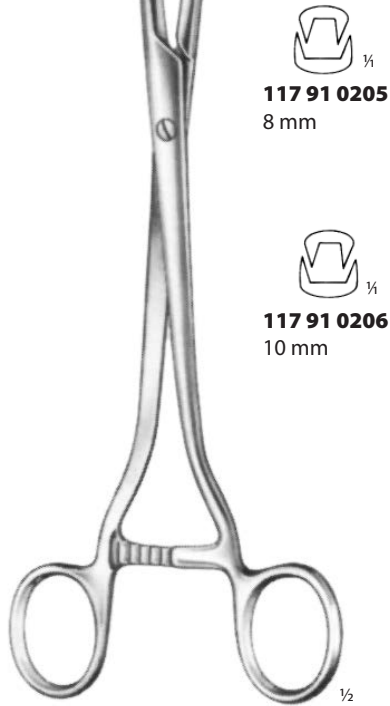

 ¼  
**117 91 0205**  
8 mm

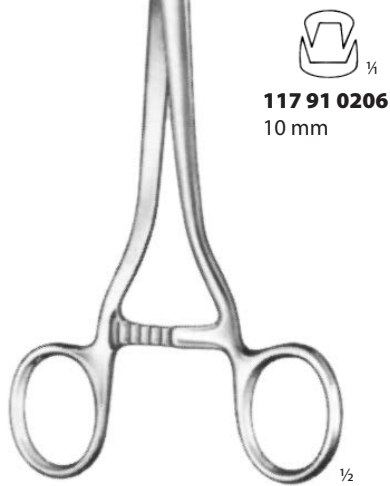

 ¼  
**117 91 0206**  
10 mm

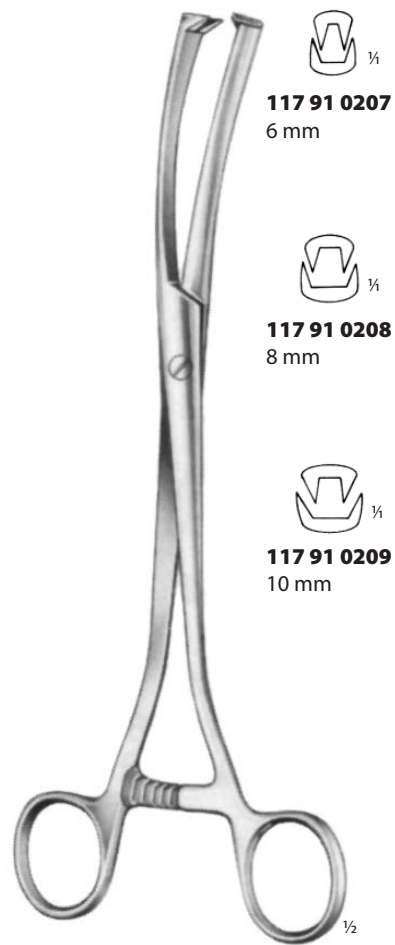

 ¼  
**117 91 0207**  
6 mm

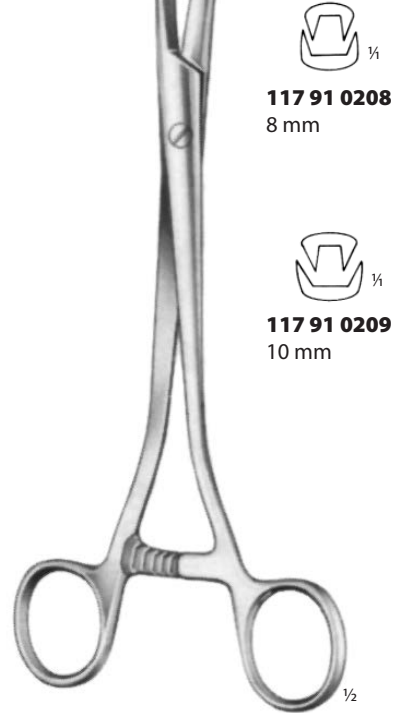

 ¼  
**117 91 0208**  
8 mm



 ¼  
**117 91 0209**  
10 mm



 ¼  
**JACOBS**  
**117 91 0212**  
21,0 cm



 ¼  
**JACOBS**  
**117 91 0213**  
21,0 cm



 ¼  
**TEALE**  
**117 91 0214**  
23,0 cm

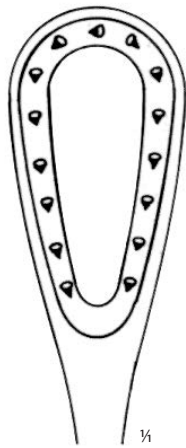

**117 91 0168**  
rovné  
straight

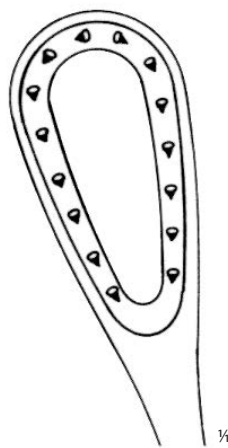

**117 91 0169**  
zahnuté  
curved

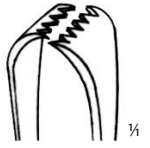

**DARTIGUES**  
**117 91 0077**  
27,0 cm

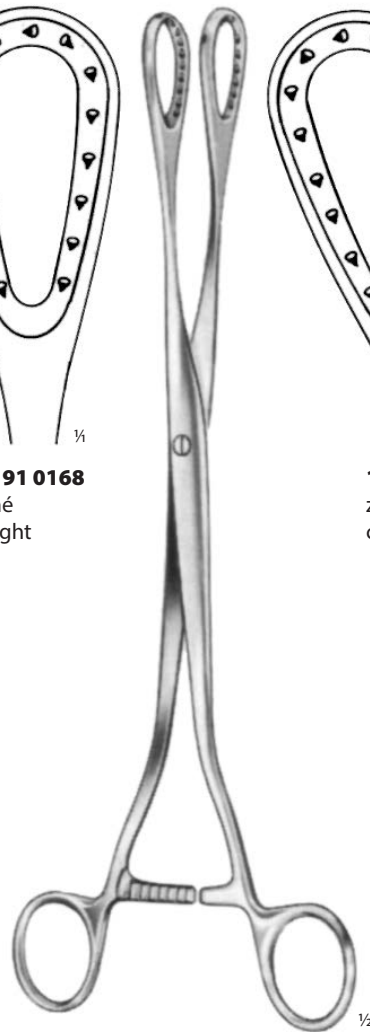

**SAENGER**  
**117 91 0168**  
27,0 cm

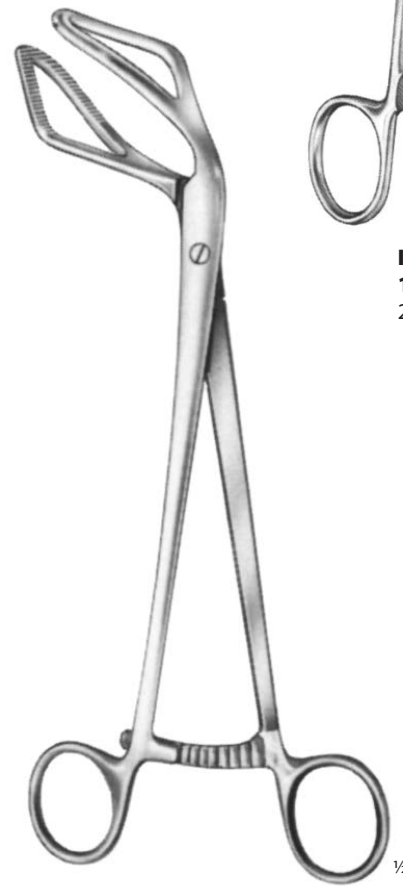

**SOMER**  
**117 91 0078**  
zahnuté  
curved  
23,0 cm



**IOWA**  
**117 91 0175**  
26,0 cm



**WINTER**  
rovné  
straight  
28,0 cm



**117 91 0165**  
rovné  
straight  
Fig. 1



**117 91 0166**  
rovné  
straight  
Fig. 2



**117 91 0289**  
rovné  
straight  
Fig. 3

**117 91 0167**  
zahnuté  
curved  
Fig. 1

**117 91 0176**  
zahnuté  
curved  
Fig. 2

**117 91 0290**  
zahnuté  
curved  
Fig. 3



**WINTER**  
zahnuté  
curved  
28,0 cm

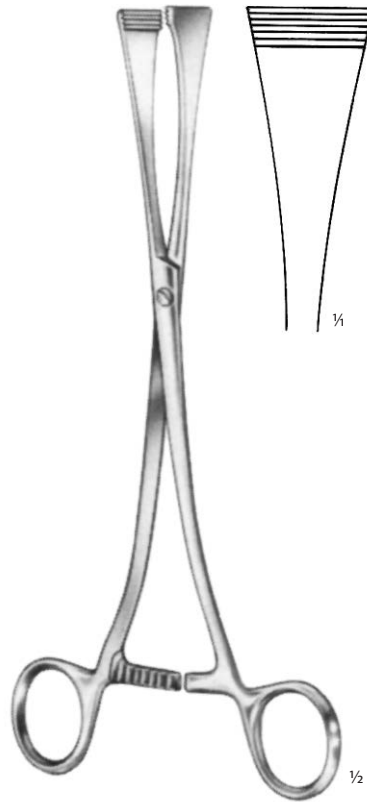

Original 40,0 cm

**NAEGELE****117 91 0154**  
36,0 cm**117 91 0155**  
40,0 cm**GREEN-ARMYTAGE****117 91 0170**  
21,0 cm**WRIGLEY****117 91 0162**  
28,0 cm**DE LEE****117 91 0163**  
30,0 cm**PIPER****117 91 0164**  
44,0 cm



**McLEAN**  
**117 91 0159**  
36,0 cm



**KIELLAND**  
**117 91 0160**  
41,0 cm



**KIELLAND-LUIKART**  
**117 91 0161**  
40,0 cm



**SIMPSON**  
**117 91 0156**  
23,0 cm



**SIMPSON**  
**117 91 0157**  
30,0 cm



**SIMPSON-BRAUN**  
**117 91 0158**  
36,0 cm



**TARNIER**  
Basiotribe  
**117 91 0173**  
46,0 cm



**BRAUN**  
Cranioclast  
**117 91 0174**  
42,0 cm



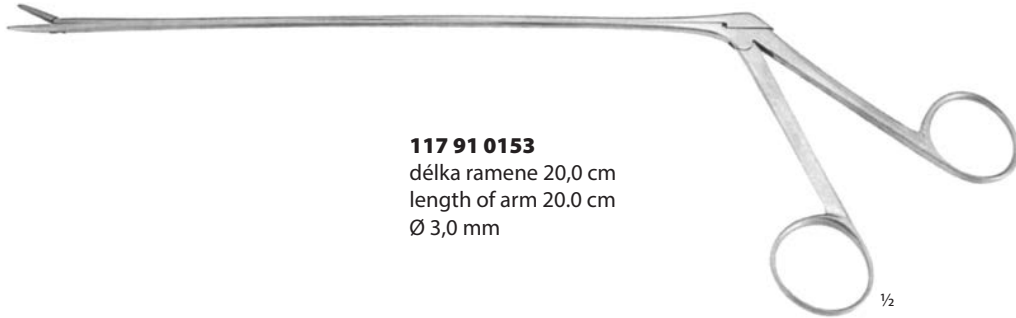

**117 91 0153**  
délka ramene 20,0 cm  
length of arm 20.0 cm  
Ø 3,0 mm

PERFORÁTORY  
PERFORATORS



**NAEGELE**  
**117 91 0171**  
25,0 cm



**SPELLIE**  
**117 91 0172**  
25,0 cm



**SMELLIE**  
**118 28 0010**  
32,0 cm



**BRAUN**  
**118 91 0317**  
30,0 cm



**BEACHAM**  
**118 91 0395**  
26,0 cm



**EMMET**  
22,0 cm



**SIMON**  
**118 91 0393**  
22,0 cm



**SIMON**  
**118 91 0394**  
22,0 cm

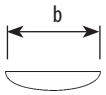
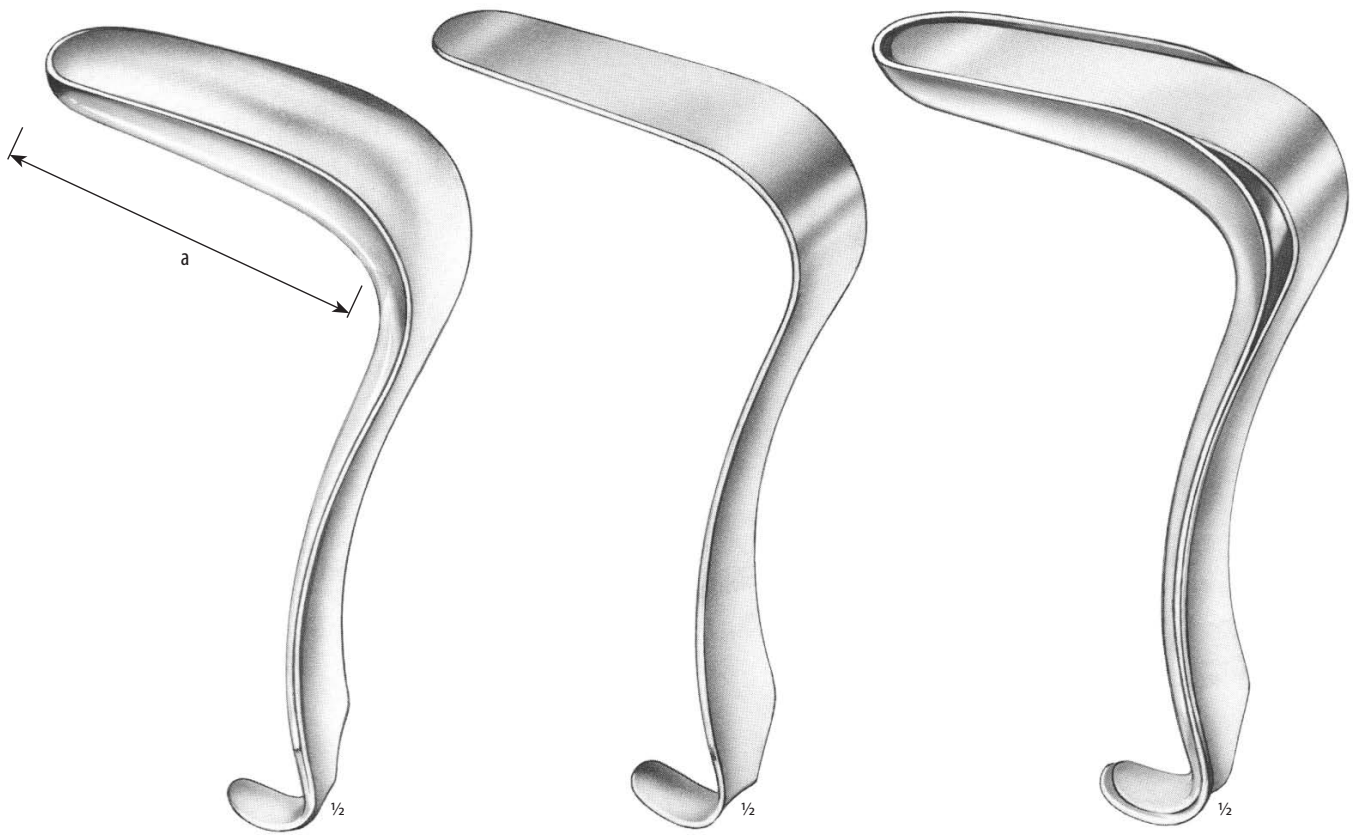

**KRISTELLER**

		a × b
Fig. 1	<b>122 91 0094</b>	70 × 27 mm
Fig. 2	<b>122 91 0095</b>	80 × 30 mm
Fig. 3	<b>122 91 0096</b>	90 × 36 mm

**KRISTELLER**

		a × b
Fig. 1	<b>122 91 0097</b>	75 × 23 mm
Fig. 2	<b>122 91 0098</b>	85 × 26 mm
Fig. 3	<b>122 91 0099</b>	100 × 32 mm

**KRISTELLER**

sada set	
	<b>122 91 0100</b>
	<b>122 91 0101</b>
	<b>122 91 0102</b>

kuželovité  
conic

Fig. 00	<b>122 91 0103</b>	105 × 18 mm
Fig. 0	<b>122 91 0104</b>	105 × 21 mm

Fig. 00	<b>122 91 0105</b>	110 × 14 mm
Fig. 0	<b>122 91 0106</b>	110 × 17 mm

	<b>122 91 0107</b>
	<b>122 91 0108</b>

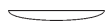

Fig. 1	<b>122 91 0109</b>	105 × 26 mm
Fig. 2	<b>122 91 0110</b>	105 × 28 mm
Fig. 3	<b>122 91 0111</b>	105 × 33 mm

Fig. 1	<b>122 91 0112</b>	115 × 22 mm
Fig. 2	<b>122 91 0113</b>	115 × 24 mm
Fig. 3	<b>122 91 0114</b>	115 × 29 mm

	<b>122 91 0115</b>
	<b>122 91 0116</b>
	<b>122 91 0117</b>



Fig. 1	<b>122 91 0118</b>	110 × 27 mm
Fig. 2	<b>122 91 0119</b>	110 × 30 mm
Fig. 3	<b>122 91 0120</b>	110 × 36 mm

Fig. 1	<b>122 91 0121</b>	115 × 23 mm
Fig. 2	<b>122 91 0122</b>	115 × 26 mm
Fig. 3	<b>122 91 0123</b>	115 × 32 mm

	<b>122 91 0124</b>
	<b>122 91 0125</b>
	<b>122 91 0126</b>



**SIMS**  
**122 91 0091**  
60 × 25/30 mm



**SIMS**  
**122 91 0092**  
70 × 30/35 mm

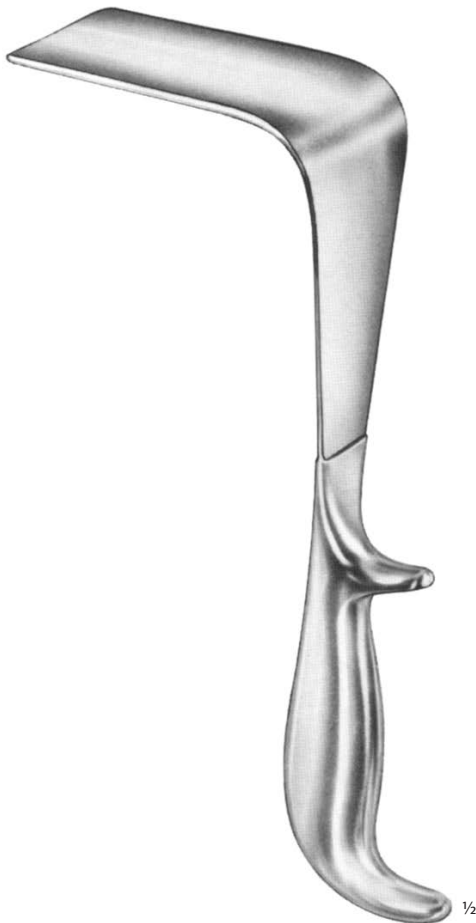

**SIMS**  
**122 91 0093**  
80 × 35/40 mm

**DOYEN**

		a × b
Fig. 1	<b>122 91 0127</b>	55 × 35 mm
Fig. 2	<b>122 91 0128</b>	85 × 35 mm
Fig. 3	<b>122 91 0129</b>	115 × 36 mm
Fig. 1	<b>122 91 0130</b>	55 × 45 mm
Fig. 2	<b>122 91 0131</b>	85 × 45 mm
Fig. 3	<b>122 91 0132</b>	115 × 45 mm
Fig. 1	<b>122 91 0133</b>	55 × 60 mm
Fig. 2	<b>122 91 0134</b>	85 × 60 mm
Fig. 3	<b>122 91 0135</b>	115 × 60 mm

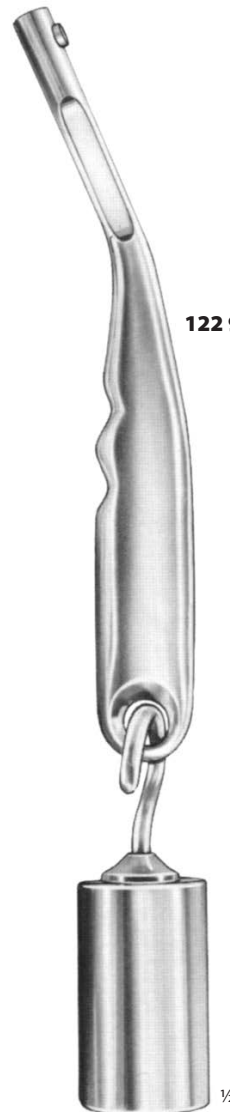
**122 91 0142****SCHERBACK**

<b>122 91 0143</b>	400 g
<b>122 91 0144</b>	800 g

<b>122 91 0136</b>	<b>122 91 0145</b>
sada	sada
set	set
<b>122 91 0137</b>	<b>122 91 0137</b>
<b>122 91 0138</b>	<b>122 91 0138</b>
<b>122 91 0139</b>	<b>122 91 0139</b>
<b>122 91 0140</b>	<b>122 91 0140</b>
<b>122 91 0141</b>	<b>122 91 0141</b>
<b>122 91 0142</b>	<b>122 91 0142</b>
<b>122 91 0143</b>	<b>122 91 0144</b>

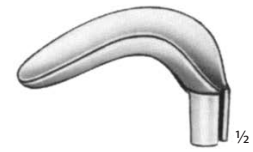
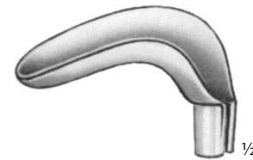
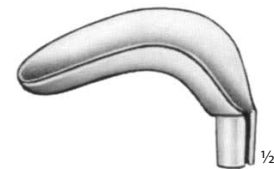
**122 91 0137**  
80 × 30 mm**122 91 0138**  
85 × 35 mm**122 91 0139**  
90 × 40 mm**122 91 0140**  
40/60 × 55 mm**122 91 0141**  
45/70 × 30 mm



**AUVARD**

**122 91 0146** 80 × 38 mm  
**122 91 0147** 102 × 45 mm



**BREISKY**

**122 91 0149** 100 × 20 mm  
**122 91 0150** 100 × 25 mm  
**122 91 0151** 100 × 30 mm  
**122 91 0152** 100 × 35 mm  
**122 91 0153** 100 × 40 mm

**122 91 0154** 130 × 20 mm  
**122 91 0155** 130 × 25 mm  
**122 91 0156** 130 × 30 mm  
**122 91 0157** 130 × 35 mm  
**122 91 0158** 130 × 40 mm

**122 91 0159** 155 × 40 mm



**LANDAU**

**122 91 0160** 105 × 28 mm  
**122 91 0161** 105 × 38 mm

**CUSCO**

<b>122 91 0001</b>	75 × 32 mm
<b>122 91 0002</b>	85 × 35 mm
<b>122 91 0003</b>	100 × 35 mm

**CUSCO-VIRGIN**

<b>122 91 0004</b>	75 × 17 mm
--------------------	------------

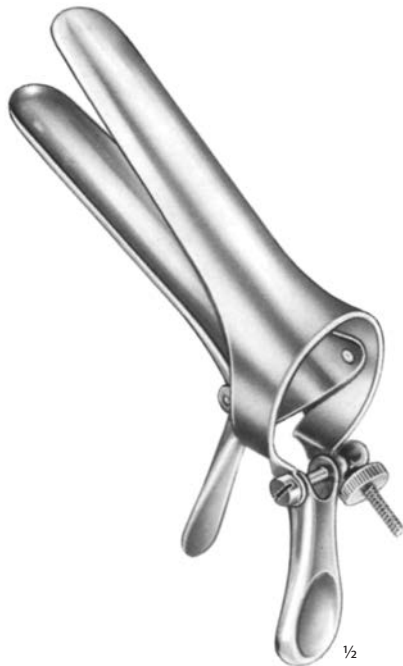
**CUSCO-SUISSE**

<b>122 91 0005</b>	80 × 22 mm
<b>122 91 0006</b>	100 × 25 mm
<b>122 91 0007</b>	105 × 27 mm

**CUSCO**

<b>122 91 0008</b>	74 × 32 mm
<b>122 91 0009</b>	85 × 35 mm
<b>122 91 0010</b>	100 × 37 mm



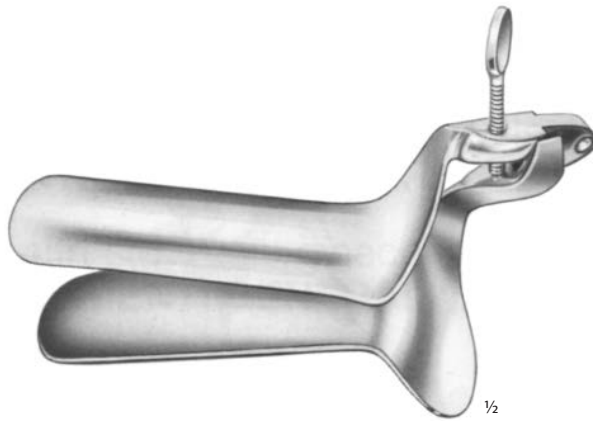

**COLLIN**

- 122 91 0011** 85 × 30 mm
- 122 91 0012** 100 × 35 mm
- 122 91 0013** 110 × 40 mm



**PEDERSON**

- 122 91 0014** 75 × 13 mm
- 122 91 0015** 100 × 22 mm
- 122 91 0016** 120 × 25 mm



**GRAVE**

- 122 91 0017** 75 × 20 mm
- 122 91 0018** 95 × 35 mm
- 122 91 0019** 115 × 35 mm

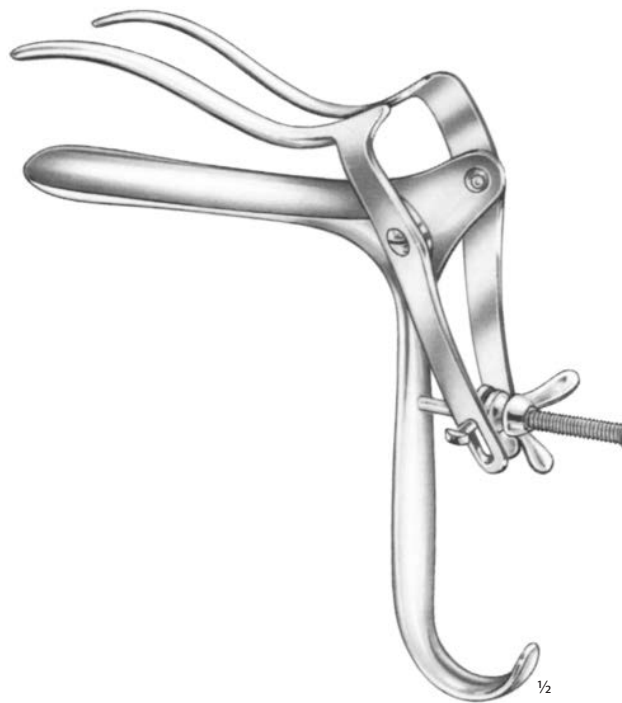

**NOTT**

- 122 91 0020** 90 × 30 mm
- 122 91 0021** 110 × 30 mm

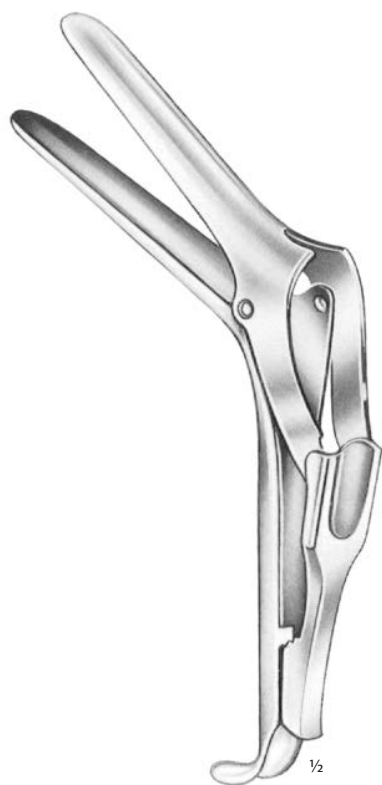
**SEMM**

- 122 91 0022** 90 × 14/18 mm  
**122 91 0023** 100 × 17/20 mm  
**122 91 0024** 100 × 25/30 mm

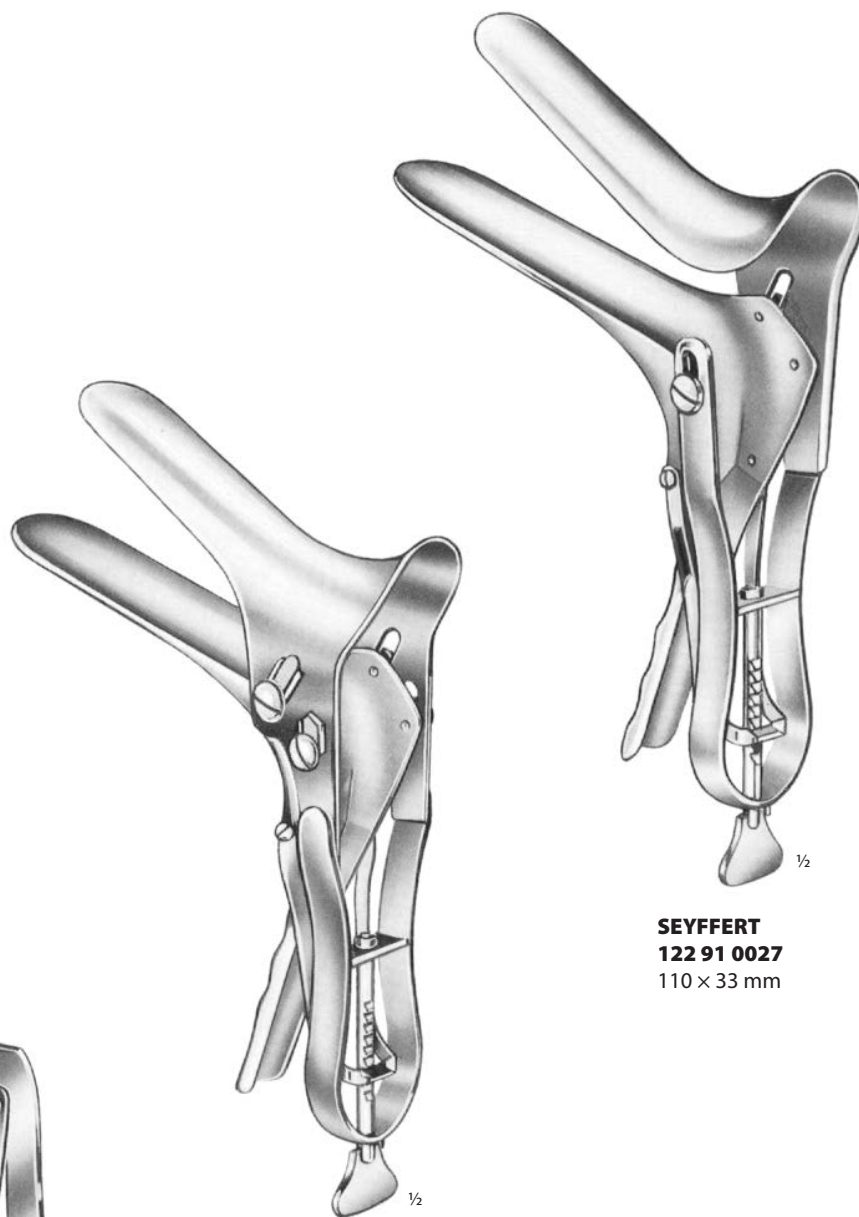

**SEYFFERT**  
**122 91 0027**  
 110 × 33 mm

- SEYFFERT**  
**122 91 0025** 100 × 17 mm  
**122 91 0026** 110 × 33 mm

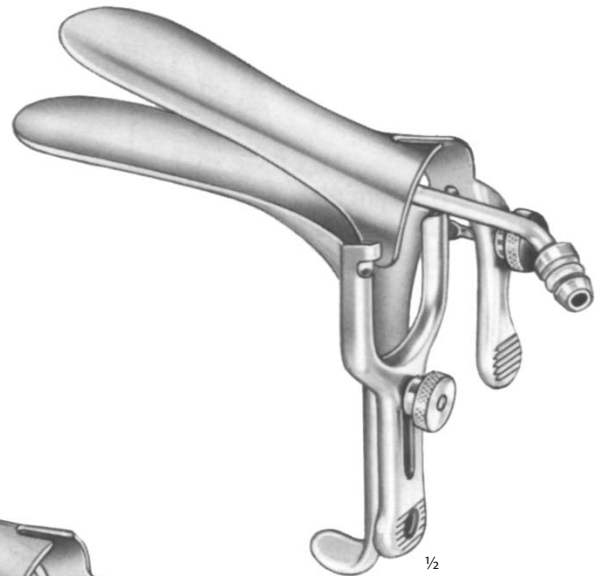

**GRAVE**  
na horním zrcadle  
on upper blade  
**122 91 0028** 75 × 13 mm  
**122 91 0030** 101 × 22 mm  
**122 91 0032** 120 × 35 mm

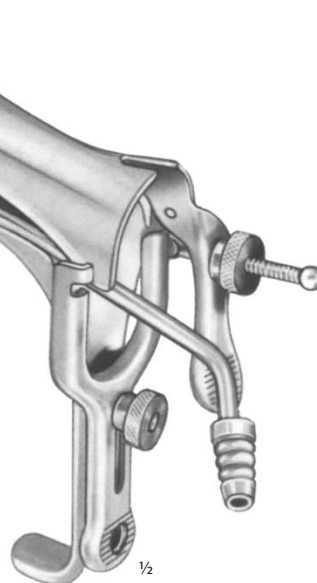

**GRAVE**  
na spodním zrcadle  
on lower blade  
**122 91 0034** 75 × 13 mm  
**122 91 0036** 101 × 22 mm  
**122 91 0038** 120 × 35 mm

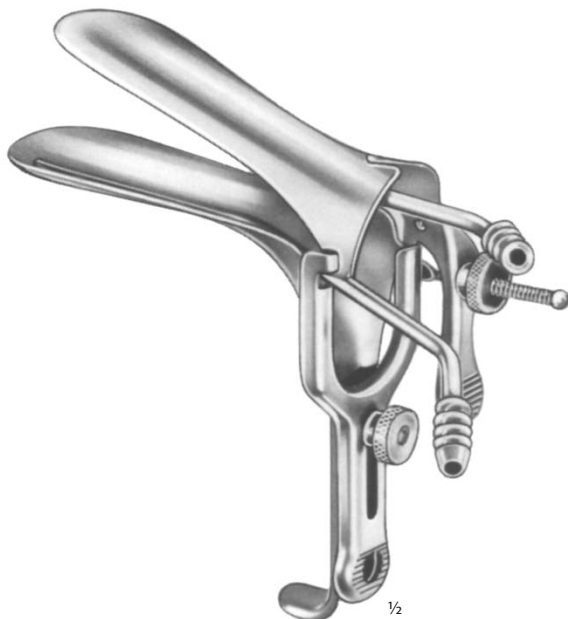

**GRAVE**  
na obou zrcadlech  
on upper and lower blade  
**122 91 0040** 75 × 13 mm  
**122 91 0042** 101 × 22 mm  
**122 91 0044** 120 × 35 mm

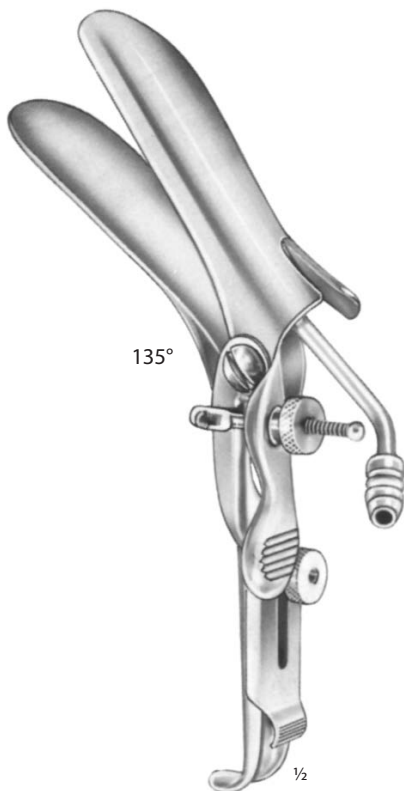
ZRCADLA POŠEVNÍ SE SACÍ TRUBIČKOU  
VAGINAL SPECULA WITH SUCTION TUBE

**GRAVE SPECIAL**  
na horním zrcadle  
on upper blade  
**122 91 0050** 101 × 35 mm

na spodním zrcadle  
on lower blade  
**122 91 0056** 101 × 35 mm

na obou zrcadlech  
on upper and lower blade  
**122 91 0062** 101 × 35 mm

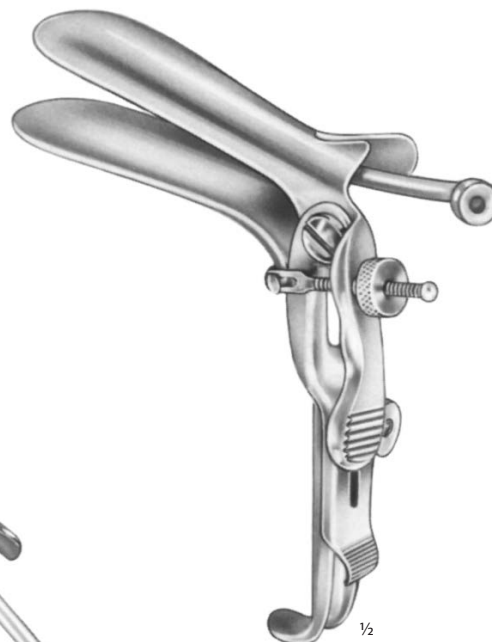

**GRAVE SPECIAL**  
na horním zrcadle  
on upper blade  
**122 91 0048** 101 × 35 mm

na spodním zrcadle  
on lower blade  
**122 91 0054** 101 × 35 mm

na obou zrcadlech  
on upper and lower blade  
**122 91 0060** 101 × 35 mm

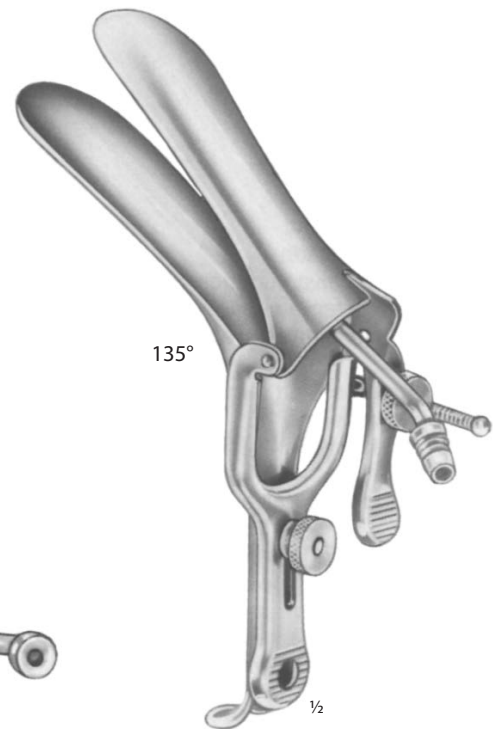

**GRAVE SPECIAL**  
na horním zrcadle  
on upper blade  
**122 91 0046** 101 × 35 mm

na spodním zrcadle  
on lower blade  
**122 91 0052** 101 × 35 mm

na obou zrcadlech  
on upper and lower blade  
**122 91 0058** 101 × 35 mm



na horním zrcadle  
on upper blade

**122 91 0064** 76 × 13 mm  
**122 91 0066** 101 × 22 mm  
**122 91 0068** 120 × 25 mm

**PEDERSON**

na spodním zrcadle  
on lower blade

**122 91 0070** 76 × 13 mm  
**122 91 0072** 101 × 22 mm  
**122 91 0074** 120 × 25 mm

na obou zrcadlech  
on upper and lower blade

**122 91 0076** 76 × 13 mm  
**122 91 0078** 101 × 22 mm  
**122 91 0080** 120 × 25 mm

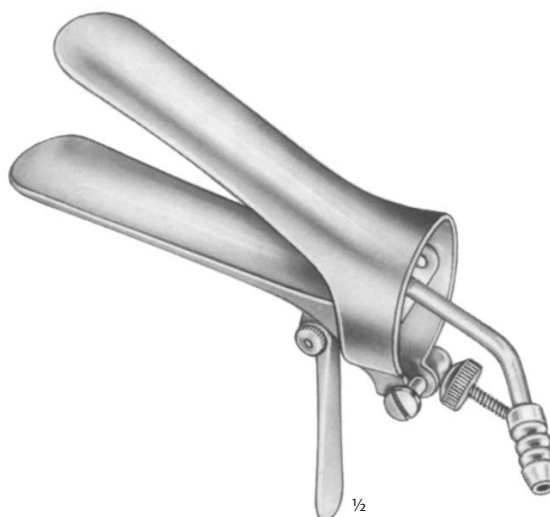

na horním zrcadle  
on upper blade

**122 91 0082** 105 × 25 mm  
**122 91 0083** 107 × 29 mm  
**122 91 0084** 115 × 35 mm

**CUSCO**

na spodním zrcadle  
on lower blade

**122 91 0085** 105 × 25 mm  
**122 91 0086** 107 × 29 mm  
**122 91 0087** 115 × 35 mm

na obou zrcadlech  
on upper and lower blade

**122 91 0088** 105 × 25 mm  
**122 91 0089** 107 × 29 mm  
**122 91 0090** 115 × 35 mm



**KOGAN**  
**122 91 0168**  
24,0 cm

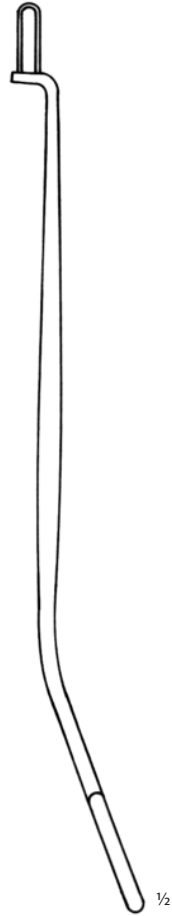

**KOGAN**  
**122 91 0169**  
24,0 cm



**KOGAN**  
**122 91 0170** 3 mm  
**122 91 0171** 7 mm



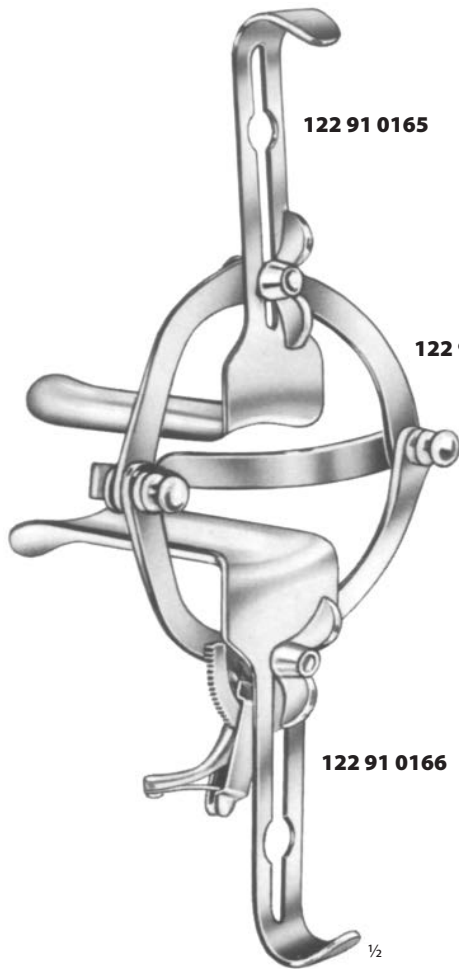

**122 91 0165**

**122 91 0163**

**122 91 0166**

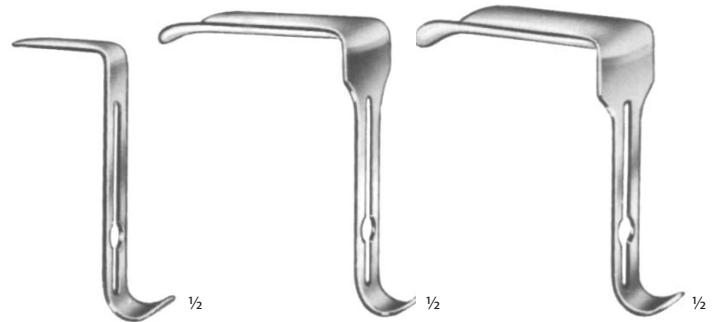

**122 91 0164**  
45 x 17 mm

**122 91 0165**  
90 x 37 mm

**122 91 0166**  
90 x 45 mm

**O'SULLIVAN-O'CONNOR**

**122 91 0162**

komplet

complete

**122 91 0163** 1x

**122 91 0164** 1x

**122 91 0165** 1x

**122 91 0166** 1x

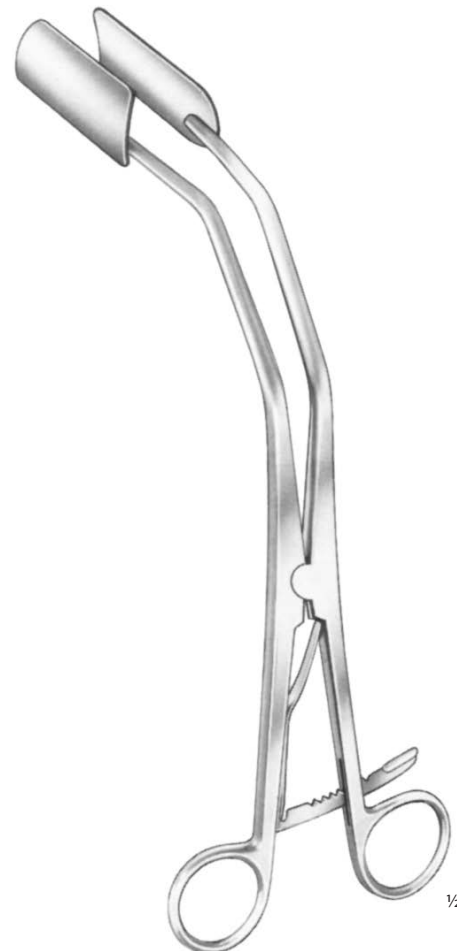

**NEW PORT**  
**122 91 0148**  
25,0 cm



7 mm



1/2

**125 27 0050**  
30,0 cm



12 mm



1/2

**125 27 0060**  
30,0 cm



**125 27 0070**  
Fig. 1  
6,8 mm



**125 27 0080**  
Fig. 2  
8,5 mm



**125 27 0090**  
Fig. 3  
10 mm



**125 27 0100**  
Fig. 4  
11,5 mm



1/2

**RECAMIER**  
31,0 cm





25,0 cm  
30,0 cm



Fig. 1  
**125 91 0001**  
**125 91 0007**



Fig. 2  
**125 91 0002**  
**125 91 0008**

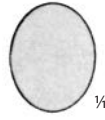
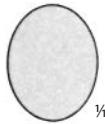

Fig. 3  
**125 91 0003**  
**125 91 0009**



25,0 cm  
30,0 cm  
Fig. 4  
**125 91 0004**  
**125 91 0010**

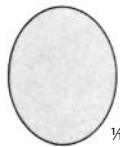

Fig. 5  
**125 91 0005**  
**125 91 0011**

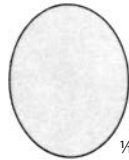

Fig. 6  
**125 91 0006**  
**125 91 0012**

Original 30,0 cm

**SIMON/SCHRÖDER**



**GOURDET**  
28,0 cm



Fig. 1  
**125 91 0013**



Fig. 2  
**125 91 0014**



Fig. 3  
**125 91 0015**



Fig. 4  
**125 91 0016**



Fig. 5  
**125 91 0017**



**WALLICH**  
**125 91 0018**  
42,0 cm



29,0 cm



**126 27 0010**  
Fig. 1



**126 27 0020**  
Fig. 2



**126 27 0030**  
Fig. 3

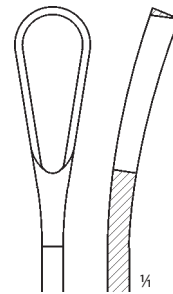

**126 27 0040**  
Fig. 4



**126 27 0050**  
Fig. 5



**126 27 0060**  
Fig. 6



**126 27 0070**  
Fig. 7

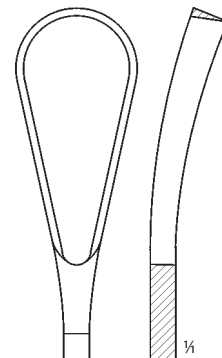

**126 27 0080**  
Fig. 8



29,0 cm



**126 27 0011**  
Fig. 1



**126 27 0021**  
Fig. 2



**126 27 0031**  
Fig. 3

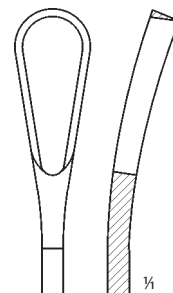

**126 27 0041**  
Fig. 4



**126 27 0051**  
Fig. 5



**126 27 0061**  
Fig. 6



**126 27 0071**  
Fig. 7

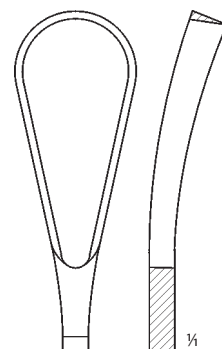

**126 27 0081**  
Fig. 8

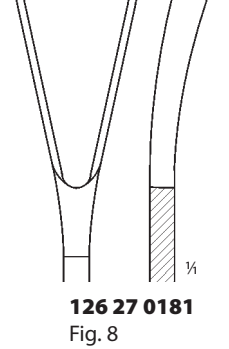
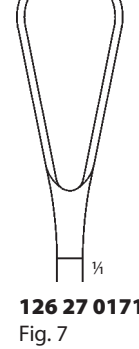
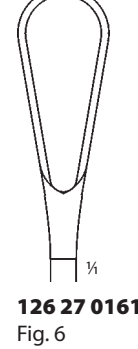
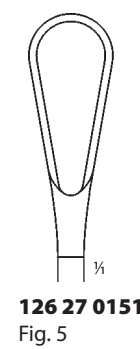
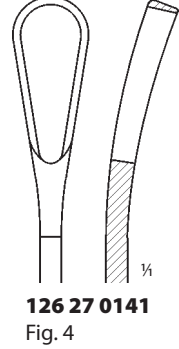
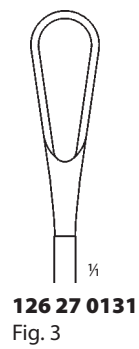
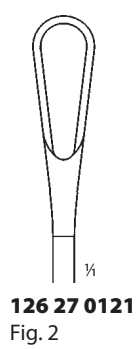
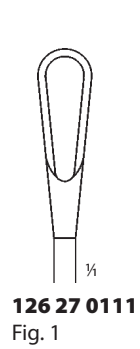
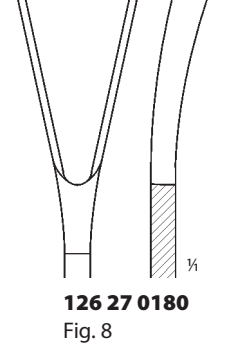
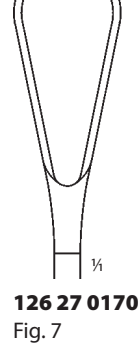
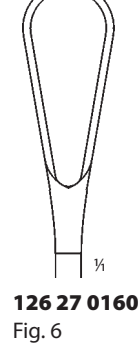
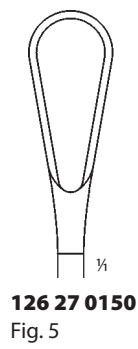
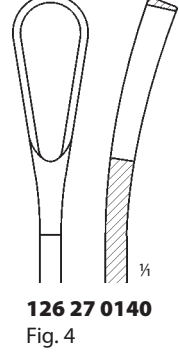
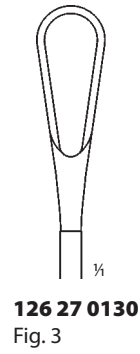
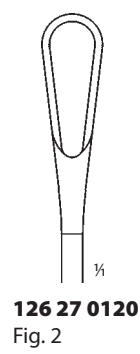
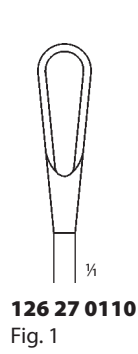

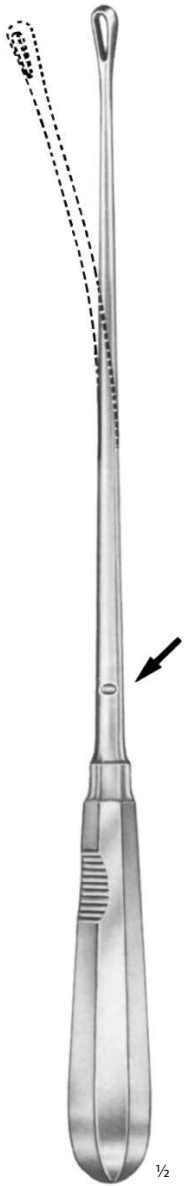

31,0 cm	
<b>126 91 0032</b>	5,0 mm
<b>126 91 0033</b>	6,0 mm
<b>126 91 0034</b>	7,0 mm
<b>126 91 0035</b>	8,0 mm
<b>126 91 0036</b>	9,0 mm
<b>126 91 0037</b>	11,0 mm
<b>126 91 0038</b>	12,0 mm
<b>126 91 0039</b>	14,0 mm
<b>126 91 0040</b>	15,0 mm
<b>126 91 0041</b>	16,0 mm
<b>126 91 0042</b>	19,0 mm
<b>126 91 0043</b>	20,0 mm
<b>126 91 0044</b>	21,0 mm
<b>126 91 0045</b>	23,0 mm

**RECAMIER/SIMS**

Fig. 00	5,0 mm
Fig. 0	6,0 mm
Fig. 1	7,0 mm
Fig. 2	8,0 mm
Fig. 3	9,0 mm
Fig. 4	11,0 mm
Fig. 5	12,0 mm
Fig. 6	14,0 mm
Fig. 7	15,0 mm
Fig. 8	16,0 mm
Fig. 9	19,0 mm
Fig. 10	20,0 mm
Fig. 11	21,0 mm
Fig. 12	23,0 mm

26,0 cm	
<b>126 91 0046</b>	5,0 mm
<b>126 91 0047</b>	6,0 mm
<b>126 91 0048</b>	7,0 mm
<b>126 91 0049</b>	8,0 mm
<b>126 91 0050</b>	9,0 mm
<b>126 91 0051</b>	11,0 mm
<b>126 91 0052</b>	12,0 mm
<b>126 91 0053</b>	14,0 mm
<b>126 91 0054</b>	15,0 mm
<b>126 91 0055</b>	16,0 mm
<b>126 91 0056</b>	19,0 mm
<b>126 91 0057</b>	20,0 mm
<b>126 91 0058</b>	21,0 mm
<b>126 91 0059</b>	23,0 mm

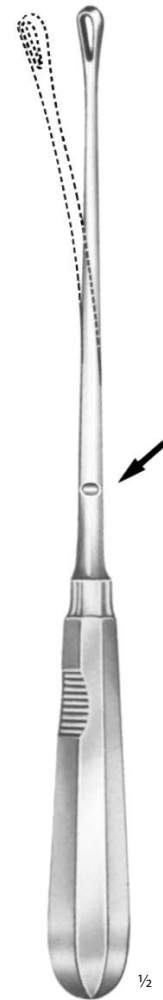
**RECAMIER/SIMS**

ohebné  
malleable  
31,0 cm

**RECAMIER/SIMS**

ohebné  
malleable  
26,0 cm

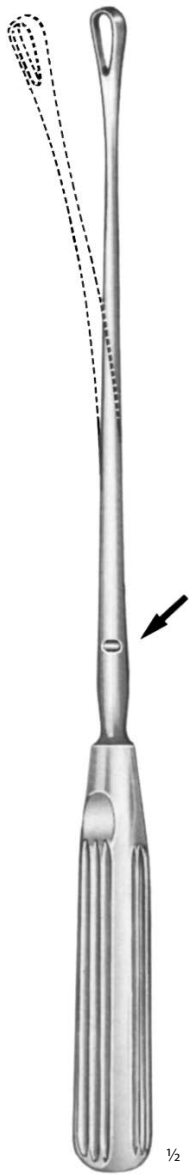

**SIMS/RECAMIER**  
ohebné  
malleable  
31,0 cm

31,0 cm

**126 91 0060**  
**126 91 0061**  
**126 91 0062**  
**126 91 0063**  
**126 91 0064**  
**126 91 0065**  
**126 91 0066**  
**126 91 0067**  
**126 91 0068**  
**126 91 0069**  
**126 91 0070**  
**126 91 0071**  
**126 91 0072**  
**126 91 0073**

5,0 mm  
6,0 mm  
7,0 mm  
8,0 mm  
9,0 mm  
11,0 mm  
12,0 mm  
14,0 mm  
15,0 mm  
16,0 mm  
19,0 mm  
20,0 mm  
21,0 mm  
23,0 mm

**SIMS/RECAMIER**

Fig. 00  
Fig. 0  
Fig. 1  
Fig. 2  
Fig. 3  
Fig. 4  
Fig. 5  
Fig. 6  
Fig. 7  
Fig. 8  
Fig. 9  
Fig. 10  
Fig. 11  
Fig. 12

5,0 mm  
6,0 mm  
7,0 mm  
8,0 mm  
9,0 mm  
11,0 mm  
12,0 mm  
14,0 mm  
15,0 mm  
16,0 mm  
19,0 mm  
20,0 mm  
21,0 mm  
23,0 mm

26,0 cm

**126 91 0074**  
**126 91 0075**  
**126 91 0076**  
**126 91 0077**  
**126 91 0078**  
**126 91 0079**  
**126 91 0080**  
**126 91 0081**  
**126 91 0082**  
**126 91 0083**  
**126 91 0084**  
**126 91 0085**  
**126 91 0086**  
**126 91 0087**

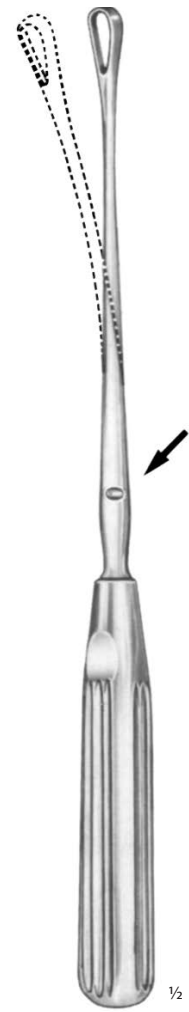

**SIMS/RECAMIER**  
ohebné  
malleable  
26,0 cm



**RECAMIER**  
34,0 cm

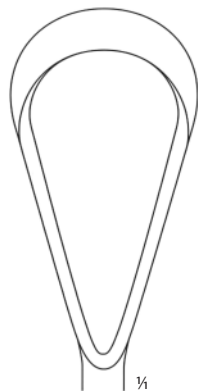

Fig. 13  
25 mm

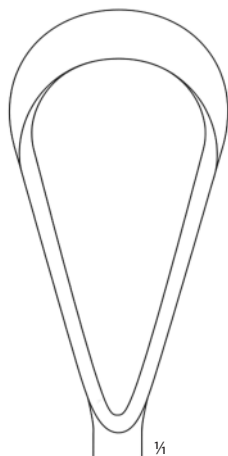

Fig. 14  
30 mm

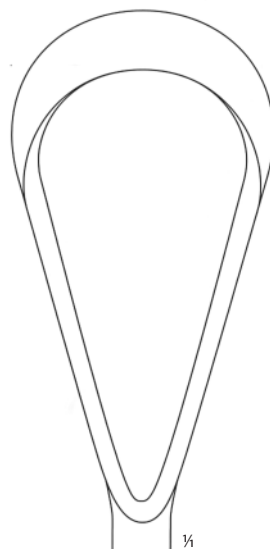

Fig. 15  
35 mm

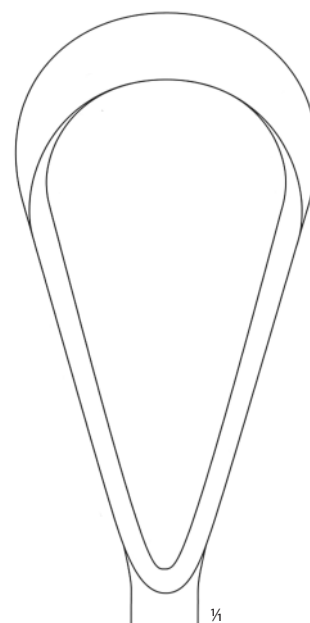
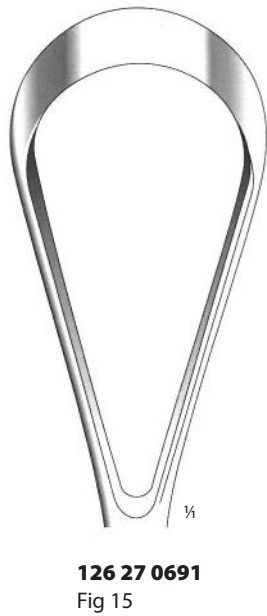

Fig. 16  
40 mm

	ostrá, neohebná sharp, rigid	ostrá, ohebná sharp, maleable	tupá, neohebná blunt, rigid	tupá, ohebná blunt, maleable
Fig. 13	<b>62-744-130</b>	<b>62-746-130</b>	<b>62-754-130</b>	<b>62-756-130</b>
Fig. 14	<b>62-744-140</b>	<b>62-746-140</b>	<b>62-754-140</b>	<b>62-756-140</b>
Fig. 15	<b>62-744-150</b>	<b>62-746-150</b>	<b>62-754-150</b>	<b>62-756-150</b>
Fig. 16	<b>62-744-160</b>	<b>62-746-160</b>	<b>62-754-160</b>	<b>62-756-160</b>



**126 27 0641**  
Fig 13



**126 27 0691**  
Fig 15

**BUMM**  
34,0 cm  
tupá, ohebná  
blunt, maleable

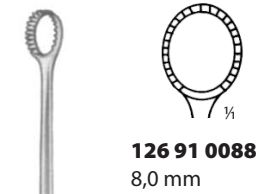

**126 91 0088**  
8,0 mm

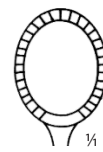

**126 91 0089**  
10,0 mm

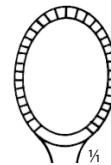

**126 91 0090**  
12,0 mm

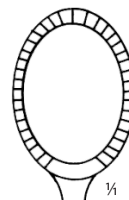

**126 91 0091**  
14,0 mm

**COLLIN**  
**126 91 0088**  
28,0 cm

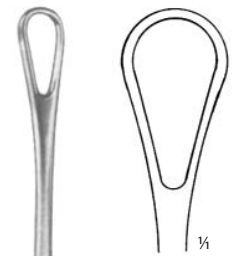

**BLAKE**  
**126 91 0092**  
27,0 cm

KYRETY NA BIOPSII, KYRETY ASPIRAČNÍ  
BIOPSY AND ASPIRATING CUTTERES

**MILAN**  
28,0 cm



**126 91 0021**  
4,0 mm



**126 91 0022**  
6,0 mm



**126 91 0023**  
9,0 mm



Kyreta aspirační  
Specimen and aspirating curette  
200 mm

<b>432-985-030</b>	Ø 3,0 mm
<b>432-985-040</b>	Ø 4,5 mm
<b>432-985-060</b>	Ø 6,0 mm
<b>432-985-080</b>	Ø 8,0 mm
<b>432-985-100</b>	Ø 10,0 mm
<b>432-985-120</b>	Ø 12,0 mm
<b>432-985-140</b>	Ø 14,0 mm



Spojka  
Connecting adaptor  
**432-985-500**  
120 mm





**RANDALL**  
**126 91 0095**  
24,0 cm  
Ø 4,0 mm



**NOVAK**  
230 mm  
**62-721-230** Ø 4,0 mm

**MINI-NOVAK**  
235 mm  
**370-588-010** Ø 1,0 mm  
**370-588-020** Ø 2,0 mm  
**370-588-030** Ø 3,0 mm  
**370-588-040** Ø 4,0 mm



**KEVORKIAN**  
**126 91 0099**  
30,0 cm



**KEVORKIAN**  
**126 91 0163**  
30,0 cm



**DOYEN**  
**126 91 0093**  
17,0 cm



**DOYEN**  
**126 91 0094**  
17,0 cm



**SIMS**  
**133 91 0151**  
32,0 cm  
neohebná  
rigid



**SIMS-SPECIAL**  
**133 91 0153**  
32,0 cm



**SIMS SWED. MODEL**  
**133 91 0154**  
26,0 cm



**MARTIN**  
**133 91 0155**  
30,0 cm



**VALLEIX**  
**133 91 0156**  
25,0 cm

**SIMS**  
**133 91 0152**  
32,0 cm  
ohebná  
malleable



**SIMS**  
**133 27 0011**  
36,5 cm

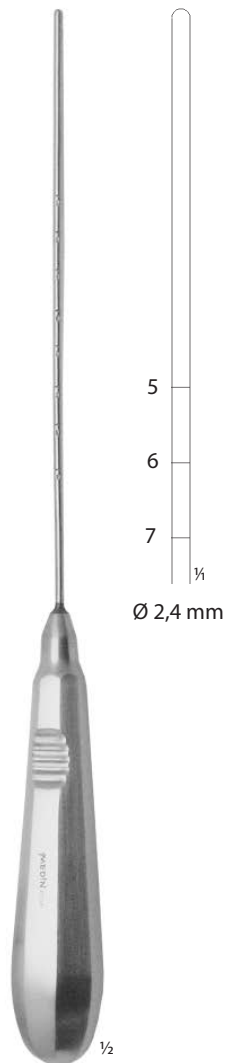

**133 27 0130**  
28,0 cm



**SAUNDERS**  
**133 91 0150**  
31,0 cm  
 $\text{Ø } 3,0 \text{ mm}$



**HEGAR**  
 tupý  
 blunt  
 18,5 cm

tupý blunt	Ø
<b>135 91 0001</b>	1,0 mm
<b>135 91 0002</b>	1,5 mm
<b>135 91 0003</b>	2,0 mm
<b>135 91 0004</b>	2,5 mm
<b>135 91 0005</b>	3,0 mm
<b>135 91 0006</b>	3,5 mm
<b>135 91 0007</b>	4,0 mm
<b>135 91 0008</b>	4,5 mm
<b>135 91 0009</b>	5,0 mm
<b>135 91 0010</b>	5,5 mm
<b>135 91 0011</b>	6,0 mm
<b>135 91 0012</b>	6,5 mm
<b>135 91 0013</b>	7,0 mm
<b>135 91 0014</b>	7,5 mm
<b>135 91 0015</b>	8,0 mm
<b>135 91 0016</b>	8,5 mm
<b>135 91 0017</b>	9,0 mm
<b>135 91 0018</b>	9,5 mm
<b>135 91 0019</b>	10,0 mm
<b>135 91 0020</b>	10,5 mm
<b>135 91 0021</b>	11,0 mm
<b>135 91 0022</b>	11,5 mm
<b>135 91 0023</b>	12,0 mm
<b>135 91 0024</b>	12,5 mm
<b>135 91 0025</b>	13,0 mm
<b>135 91 0026</b>	13,5 mm
<b>135 91 0027</b>	14,0 mm
<b>135 91 0028</b>	14,5 mm
<b>135 91 0029</b>	15,0 mm
<b>135 91 0030</b>	15,5 mm
<b>135 91 0031</b>	16,0 mm
<b>135 91 0032</b>	16,5 mm
<b>135 91 0033</b>	17,0 mm
<b>135 91 0034</b>	17,5 mm
<b>135 91 0035</b>	18,0 mm
<b>135 91 0036</b>	18,5 mm
<b>135 91 0037</b>	19,0 mm
<b>135 91 0038</b>	19,5 mm
<b>135 91 0039</b>	20,0 mm
<b>135 91 0040</b>	21,0 mm
<b>135 91 0041</b>	22,0 mm
<b>135 91 0042</b>	23,0 mm
<b>135 91 0043</b>	24,0 mm
<b>135 91 0044</b>	25,0 mm
<b>135 91 0045</b>	26,0 mm
<b>135 91 0046</b>	27,0 mm
<b>135 91 0047</b>	28,0 mm
<b>135 91 0048</b>	29,0 mm
<b>135 91 0049</b>	30,0 mm

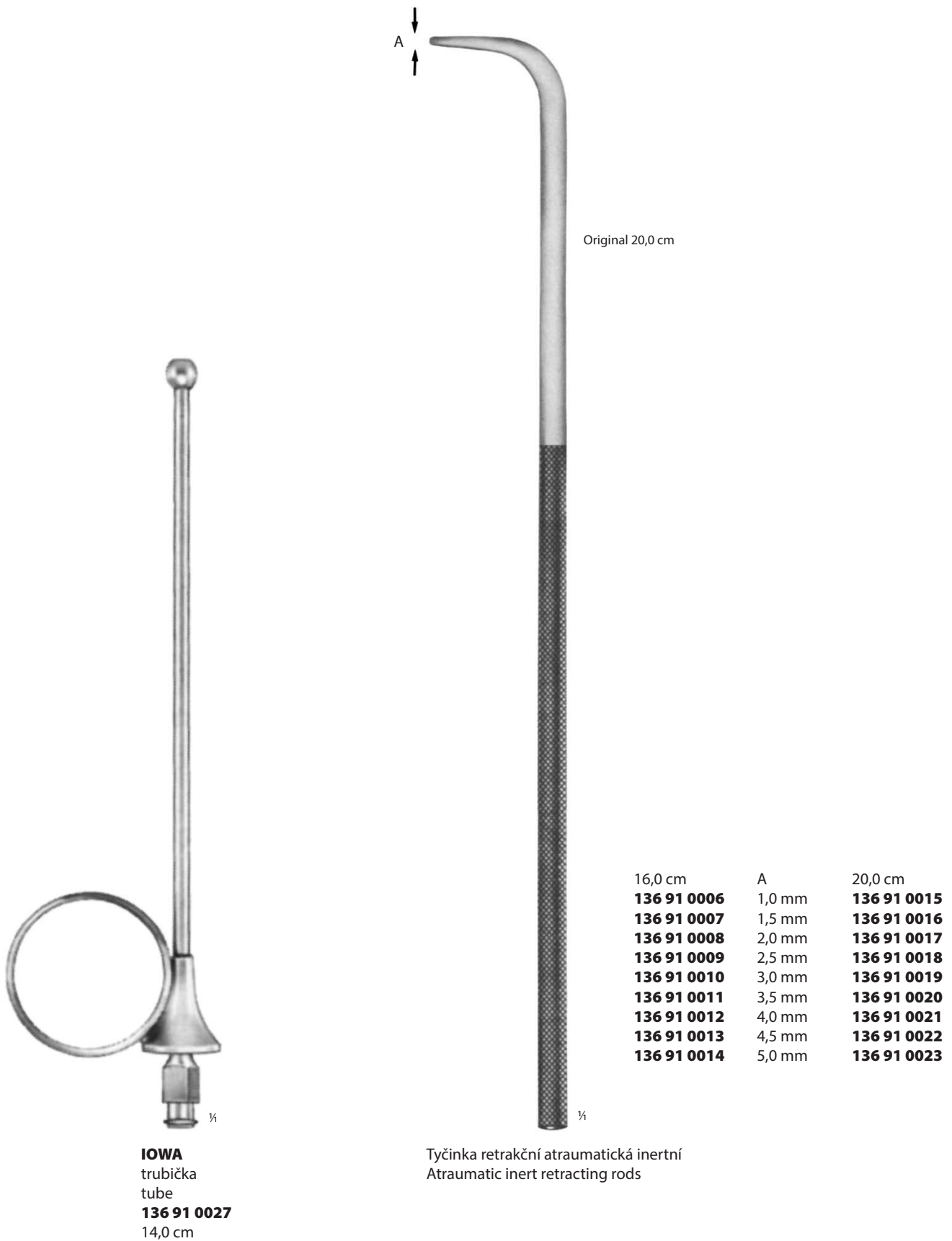
NÁSTROJ NA PLODOVÝ VAK, TYČINKY RETRAKČNÍ  
INSTRUMENT FOR THE AMNIOM BLADDER, RETRACTING RODS

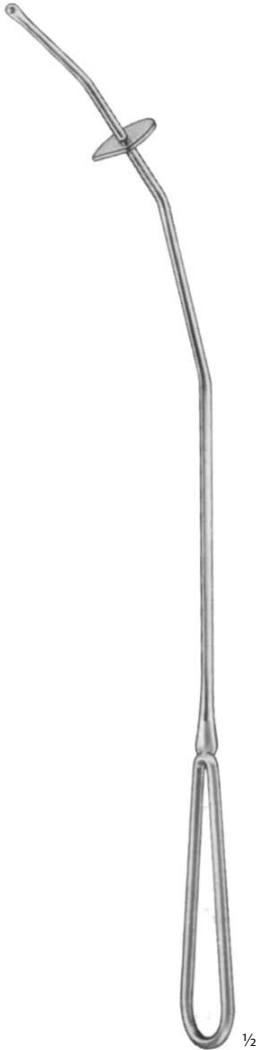

**RAMATHIBODI**  
Manipulátor děložní  
Uterine manipulator  
**136 91 0025**  
27,5 cm



**RAMATHIBODI**  
Hák  
Tubal hook  
**136 91 0026**  
25,0 cm

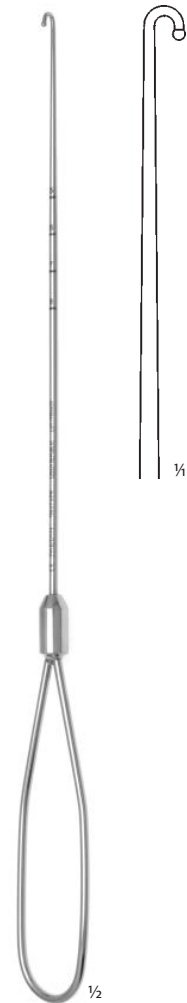

Extraktor  
Extractor  
**136 27 0310**  
26,5 cm





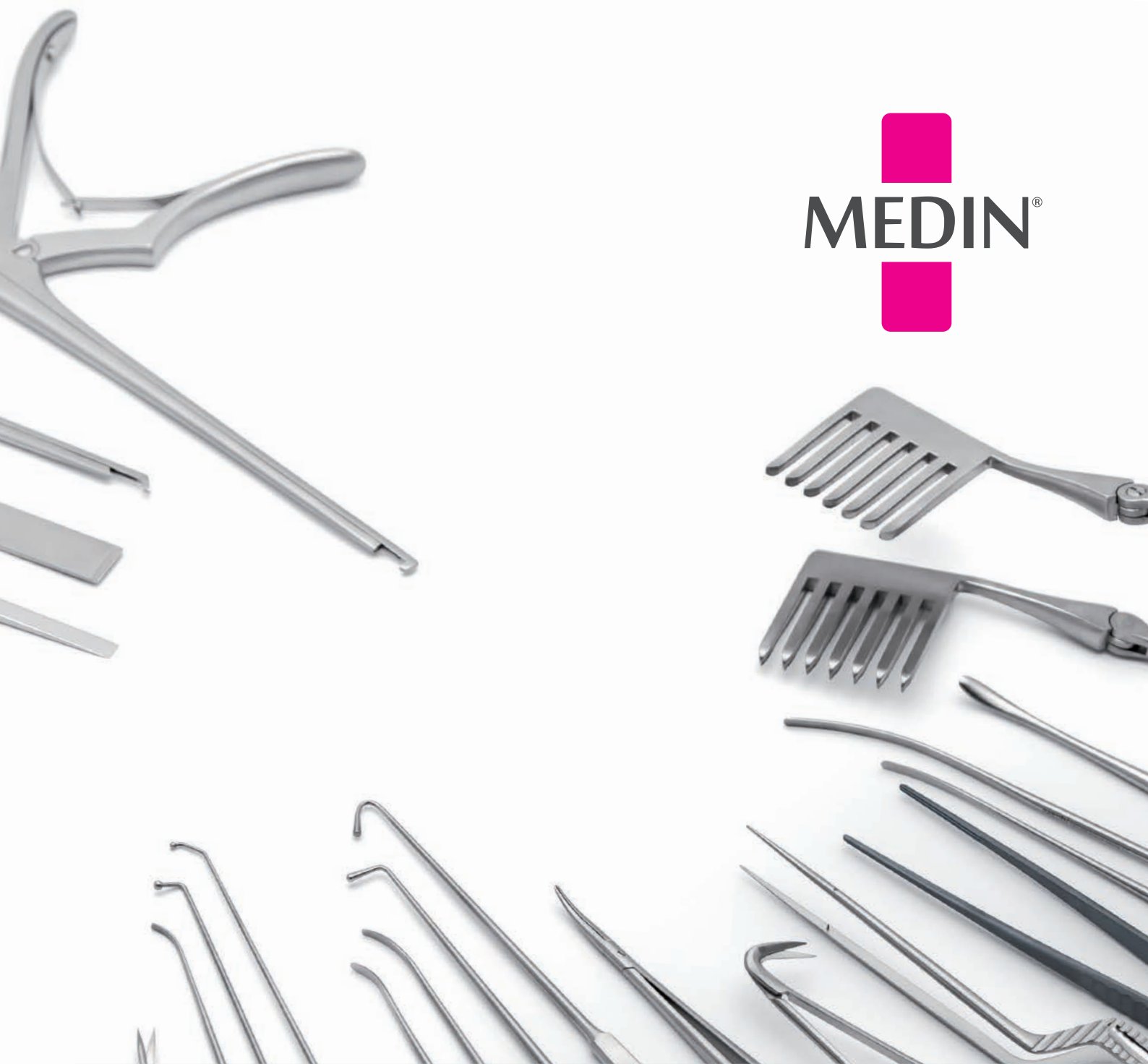

**NÁSTROJE PRO NEUROCHIRURGII**  
**INSTRUMENTS FOR NEUROSURGERY**





MEDIN, a.s.  
Vlachovická 619  
Nové Město na Moravě  
CZ 592 31  
Czech Republic  
IČO: 43378030  
DIČ: CZ43378030

**CENTRÁLA**  
tel.: 566 684 111

**PRODEJ ČESKÁ REPUBLIKA**  
tel.: 566 684 327  
fax: 566 684 384  
e-mail: prodej@medin.cz

**EXPORT**  
phone: +420 566 684 250  
fax: +420 566 684 385  
e-mail: export@medin.cz

**[www.medin.cz](http://www.medin.cz)**

MEDIN Slovensko, s.r.o.  
Mlynská 10  
Piešťany  
SK 921 01  
Slovak Republic  
IČO: 46540873  
SK DPH: SK2023412688

tel.: +421 337 746 259  
fax: +421 337 746 153  
e-mail: jana.snajdarova@medin.sk

**[www.medin.sk](http://www.medin.sk)**

<b>397 112</b>	<b>Nástroje řezné</b>	Cutting Instruments	501–503
<b>397 113</b>	<b>Nůžky</b>	Scissors	504–506
<b>397 114</b>	<b>Pinzety</b>	Forceps	507–509
<b>397 115</b>	<b>Svorky</b>	Clamps, Forceps	510–511
<b>397 116</b>	<b>Kleště štípací</b>	Rongeurs	512–525
<b>397 117</b>	<b>Kleště úchopné</b>	Grasping Forceps	526–527
<b>397 118</b>	<b>Háky</b>	Hooks, Retractors	528–533
<b>397 119</b>	<b>Rozvěrače</b>	Retractors	534–545
<b>397 121</b>	<b>Lopatky</b>	Spatulas	546
<b>397 122</b>	<b>Zrcadla</b>	Specula	547
<b>397 123</b>	<b>Páčidla</b>	Elevators	548–554
<b>397 126</b>	<b>Kyrety</b>	Curettes	555–558
<b>397 127</b>	<b>Pilky</b>	Saws	559
<b>397 128</b>	<b>Dláta</b>	Chisels	560–561

POZNÁMKA:

Katalogová čísla MEDIN jsou v katalogu uvedena ve zkrácené podobě bez předčísí pro zdravotnické prostředky.

Například: katalogové číslo / objednáací číslo  
          XXX XX XXXX / 397XXXXXXXXX

Aktuální konverzní tabulku nebo ceník s kompletními objednáacími čísly si vyžádejte u svého obchodního zástupce.

NOTE:

MEDIN catalogue numbers in this catalogue are listed in short form without the prefix for medical devices.

For example: catalogue number / order number  
              XXX XX XXXX / 397XXXXXXXXX

Ask your sales representative for the up-to-date conversion table or the price list with complete ordering numbers.

© 2018 MEDIN, a.s.; Všechna práva vyhrazena.

Dokument je určen pro obchodní účely MEDIN, a.s., údaje zde uvedené jsou informativního charakteru.

Žádná část tohoto dokumentu nesmí být reprodukována nebo publikována v jakékoliv formě bez předchozího souhlasu MEDIN, a.s. Zobrazení produktů odpovídá aktuálnímu stavu v době vydání tohoto dokumentu. Změny technických parametrů z důvodu dalšího vývoje jsou vyhrazeny.

Tiskové a typografické chyby jsou vyhrazeny.

© 2018 MEDIN, a.s.; All rights reserved.

This document should be used for commercial purposes of MEDIN, a.s.; the data mentioned in the document has informative character. No part of this document can be copied or published in any form without approval of MEDIN, a.s.

The product design may differ from those depicted in these illustrations at the date of issue. Adjustments, made from the reason of further developments of technical parameters, are reserved.

Printing and typographical errors are reserved.



Nástroj mikro  
Micro instrument  
18,5 cm

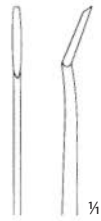

**112 91 0309**  
18,5 cm



**112 91 0310**  
18,5 cm

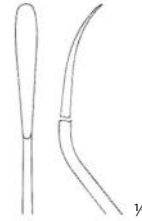

**112 91 0314**  
18,5 cm

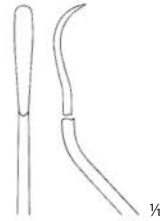

**112 91 0315**  
18,5 cm

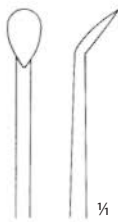

**112 91 0311**  
18,5 cm



**112 91 0312**  
18,5 cm

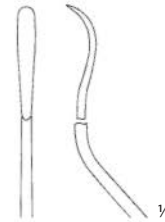

**112 91 0316**  
18,5 cm

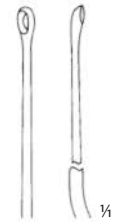

**112 91 0317**  
18,5 cm



**112 91 0313**  
18,5 cm



Nástroj mikro  
Micro instrument  
18,5 cm



**KOOS**  
19,0 cm



**112 91 0318**  
19,0 cm



**112 91 0319**  
19,0 cm



**112 91 0320**  
19,0 cm



**112 91 0321**  
19,0 cm



**112 91 0322**  
19,0 cm



**112 91 0323**  
19,0 cm



boční ostří  
lateral cutting edge



**KRAUS**  
**112 91 0324**  
19,0 cm



Nástroj mikro  
Micro instrument  
**112 91 0325**  
19,0 cm



Nástroj mikro  
Micro instrument  
**112 91 0326**  
19,0 cm



**JACOBSON**  
**112 91 0327**  
19,0 cm



**113 91 0726**  
20,0 cm



**NAGEL**  
**113 91 0725**  
45°  
20,0 cm



**113 91 0726**  
45°  
20,0 cm



**113 91 0727**  
125°  
20,0 cm





**113 91 0728**  
rovné – straight  
16,0 cm

**113 91 0729**  
zahnuté – curved  
16,0 cm



**VANNAS**  
**113 91 0730**  
rovné – straight  
16,0 cm

**VANNAS**  
**113 91 0731**  
zahnuté – curved  
16,0 cm

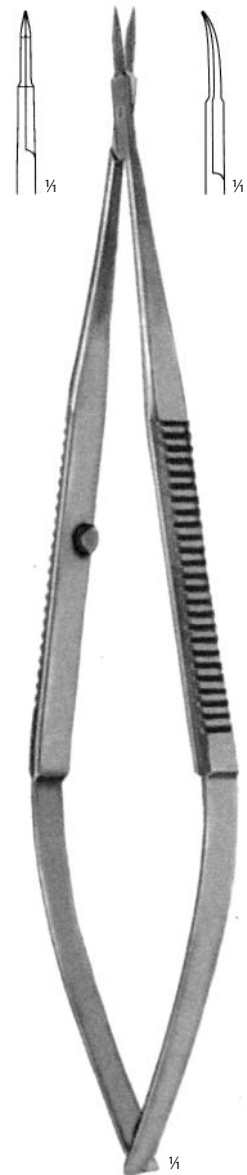

**MILLES I**  
**113 91 0732**  
rovné – straight  
se zuby – saw edge  
16,0 cm

**MILLES I**  
**113 91 0733**  
zahnuté – curved  
se zuby – saw edge  
16,0 cm

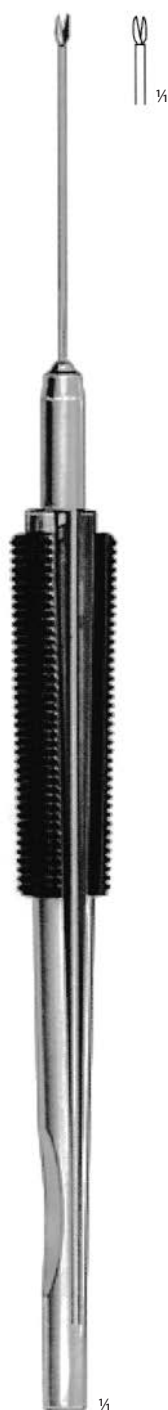

**113 91 0734**  
18,5 cm



**113 91 0735**  
19,0 cm



**114 91 0566**  
20,0 cm



0,6 mm

**114 91 0563**  
18,0 cm

**114 91 0566**  
20,0 cm

**114 91 0568**  
22,0 cm

**114 91 0570**  
24,0 cm



0,9 mm

**114 91 0564**  
18,0 cm

**114 91 0567**  
20,0 cm

**114 91 0569**  
22,0 cm

**114 91 0571**  
24,0 cm



1×2

**114 91 0565**  
18,0 cm

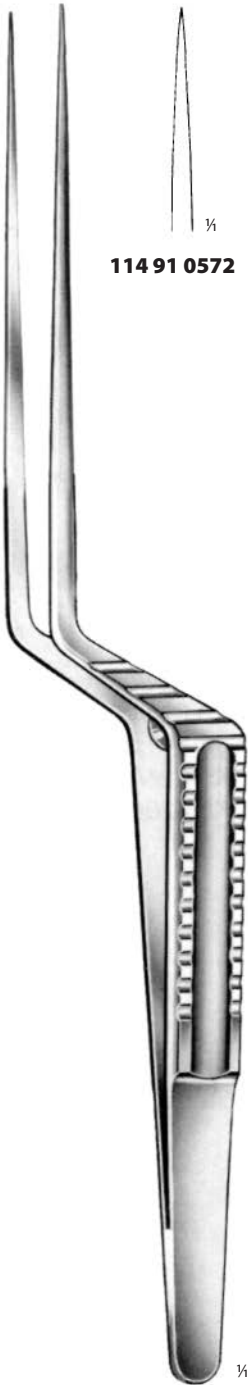

114 91 0572

Pinzeta Mikro  
Micro forceps  
**114 91 0573**  
18,5 cm

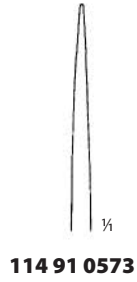

114 91 0573



114 91 0574



Pinzeta šíci  
Suture forceps  
**114 91 0575**  
22,0 cm



Pinzeta šíci  
Suture Forceps  
**114 91 0576**  
18,5 cm



**DIETRICH**  
**114 91 0581**  
20,0 cm  
titan – titanium



1,5 mm

**114 91 0577**  
titan – titanium  
15,0 cm

**114 91 0580**  
titan – titanium  
20,0 cm

**114 91 0583**  
titan – titanium  
24,0 cm



2,0 mm

**114 91 0578**  
titan – titanium  
15,0 cm

**114 91 0581**  
titan – titanium  
20,0 cm

**114 91 0584**  
titan – titanium  
24,0 cm



2,8 mm

**114 91 0579**  
titan – titanium  
15,0 cm

**114 91 0582**  
titan – titanium  
20,0 cm

**114 91 0585**  
titan – titanium  
24,0 cm

SVORKY NA CÉVY JEMNÉ  
FINE ARTERY FORCEPS

**HOEN**  
**115 91 0804**  
13,5 cm



**RAIMONDI**  
**115 91 0805**  
12,5 cm

SVORKY PREPARAČNÍ  
DISSECTING FORCEPS

**115 91 0806**  
19,5 cm



**115 91 0807**  
19,5 cm



18,5 cm



**115 91 0808**  
18,5 cm



**115 91 0809**  
18,5 cm

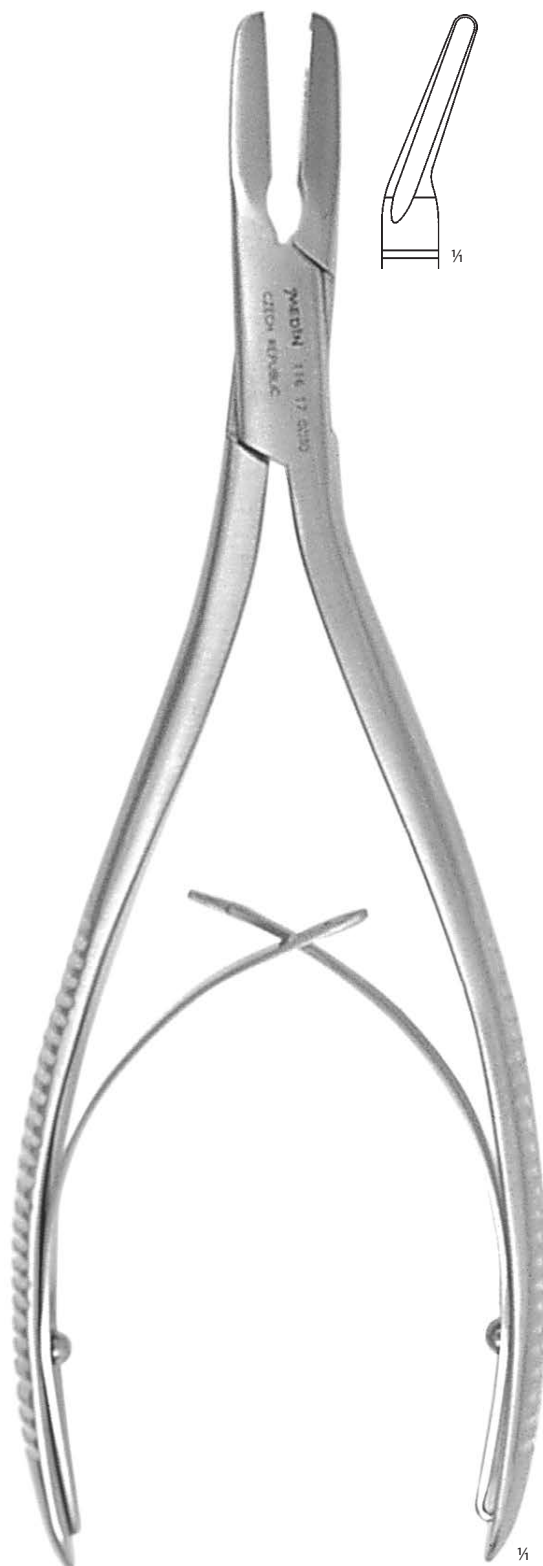

**ZIELKE**  
**116 17 0330**  
20,4 cm



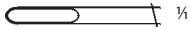

**116 17 0360**  
12 × 2 mm

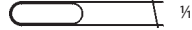

**116 17 0380**  
12 × 3 mm

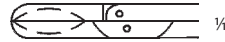

12 × 3 mm  
přímé rovné  
straight



**116 17 0390**  
12 × 4 mm



**116 17 0400**  
12 × 5 mm



**116 17 0410**  
12 × 6 mm

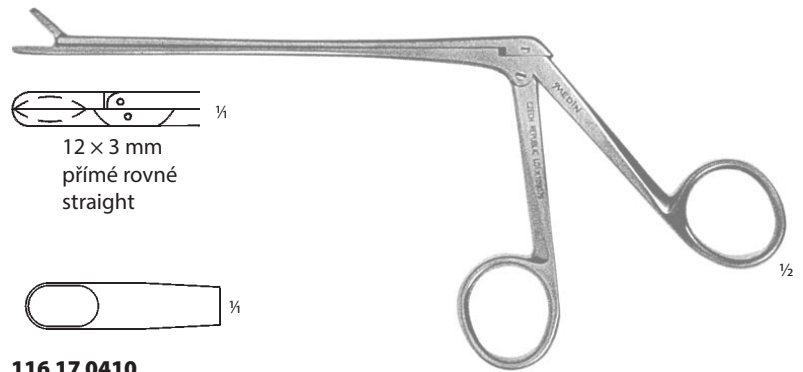

**116 17 0380**  
délka ramene 14,0 cm  
length of arm 14.0 cm

KLEŠTĚ NA MEZIOBRATLOVÉ PLOTÉNKY  
LAMINECTOMY RONGEURS

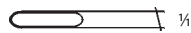

**116 17 0840**  
12 × 2 mm



**116 17 0860**  
12 × 3 mm

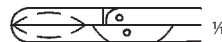

13 × 5 mm  
přímé rovné  
straight

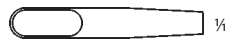

**116 17 0870**  
13 × 4 mm



**116 17 0880**  
13 × 5 mm



**116 17 0890**  
12 × 6 mm

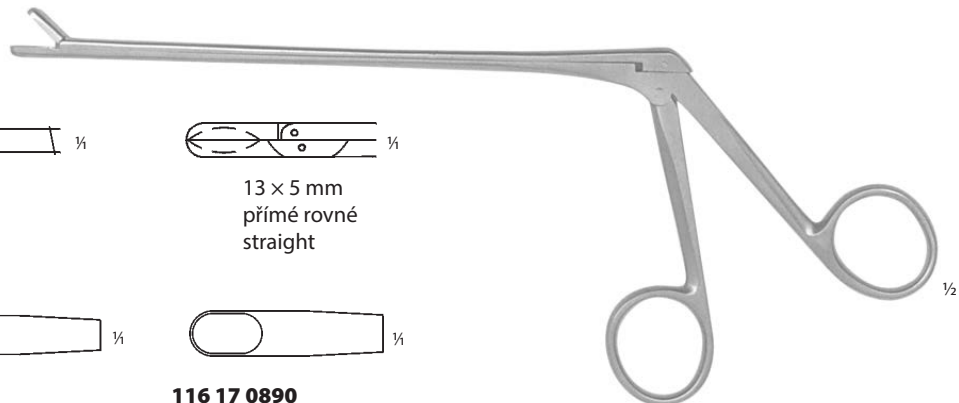

**116 17 0880**  
délka ramene 18,0 cm  
length of arm 18.0 cm

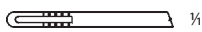

**116 17 0600**  
12 × 2 mm

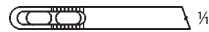

**116 17 0620**  
12 × 3 mm



12 × 3 mm  
přímé rovné se zuby  
straight with saw edge



**116 17 0630**  
13 × 4 mm



**116 17 0640**  
13 × 5 mm

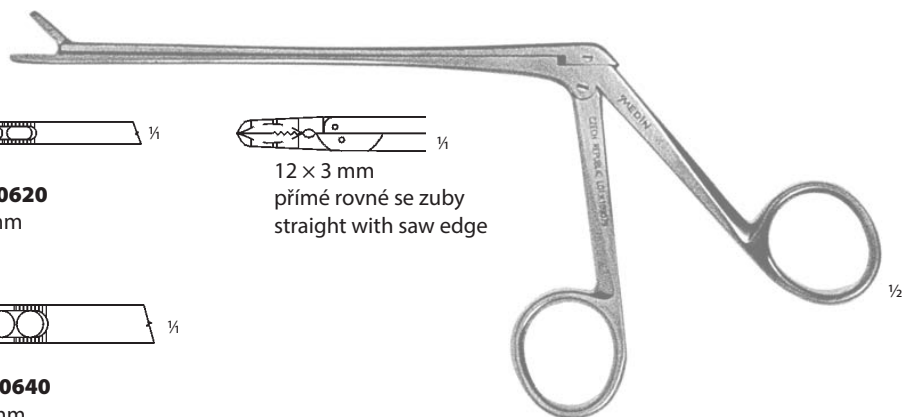

**116 17 0620**  
délka ramene 16,0 cm  
length of arm 16.0 cm

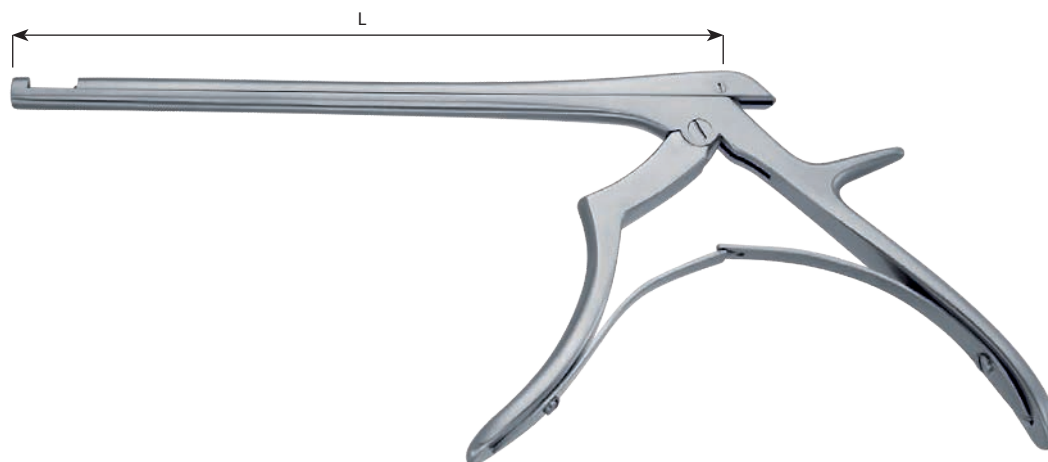
ŠTÍPÁKY NA LAMINEKTOMII  
LAMINECTOMY RONGEURS

FERRIS-SMITH-KERRISON



	L = 150 mm	L = 180 mm	L = 200 mm	L = 230 mm
1 mm	<b>29-414-001</b>	<b>340-506-010</b>	<b>340-502-010</b>	<b>29-430-001</b>
2 mm	<b>29-414-002</b>	<b>29-420-002</b>	<b>340-502-020</b>	<b>29-430-002</b>
3 mm	<b>29-414-003</b>	<b>29-420-003</b>	<b>340-502-030</b>	<b>29-430-003</b>
4 mm	<b>29-414-004</b>	<b>340-506-040</b>	<b>340-502-040</b>	<b>29-430-004</b>
5 mm	<b>29-414-005</b>	<b>29-420-005</b>	<b>340-502-050</b>	<b>29-430-005</b>
6 mm	<b>29-414-006</b>	<b>340-506-060</b>	<b>340-502-060</b>	<b>29-430-006</b>



	L = 150 mm	L = 180 mm	L = 200 mm	L = 230 mm
1 mm	<b>29-416-001</b>	<b>340-507-010</b>	<b>340-500-010</b>	<b>29-432-001</b>
2 mm	<b>29-416-002</b>	<b>29-422-002</b>	<b>340-500-020</b>	<b>29-432-002</b>
3 mm	<b>29-416-003</b>	<b>29-422-003</b>	<b>340-500-030</b>	<b>29-432-003</b>
4 mm	<b>29-416-004</b>	<b>340-507-040</b>	<b>340-500-040</b>	<b>29-432-004</b>
5 mm	<b>29-416-005</b>	<b>29-422-005</b>	<b>340-500-050</b>	<b>29-432-005</b>
6 mm	<b>29-416-006</b>	<b>340-507-060</b>	<b>340-500-060</b>	<b>29-432-006</b>

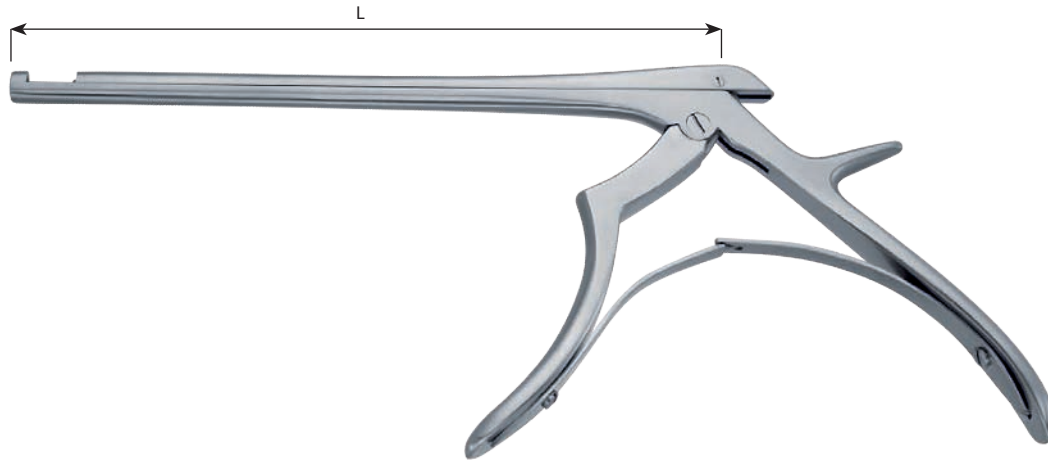

FERRIS-SMITH-KERRISON



	1 mm	L = 150 mm <b>29-418-001</b>	L = 180 mm <b>340-508-010</b>	L = 200 mm <b>340-503-010</b>	L = 230 mm <b>29-434-001</b>
	2 mm	<b>29-418-002</b>	<b>29-424-002</b>	<b>340-503-020</b>	<b>29-434-002</b>
	3 mm	<b>29-418-003</b>	<b>29-424-003</b>	<b>340-503-030</b>	<b>29-434-003</b>
	4 mm	<b>29-418-004</b>	<b>340-508-040</b>	<b>340-503-040</b>	<b>29-434-004</b>
	5 mm	<b>29-418-005</b>	<b>29-424-005</b>	<b>340-503-050</b>	<b>29-434-005</b>
	6 mm	<b>29-418-006</b>	<b>340-508-060</b>	<b>340-503-060</b>	<b>29-434-006</b>

	1 mm	L = 180 mm <b>340-509-010</b>	L = 200 mm <b>340-519-010</b>	L = 230 mm <b>29-436-002</b>
	2 mm	<b>340-509-020</b>	<b>340-519-020</b>	<b>29-436-003</b>
	3 mm	<b>340-509-030</b>	<b>340-519-030</b>	<b>29-436-004</b>
	4 mm	<b>340-509-040</b>	<b>340-519-040</b>	<b>29-436-005</b>
	5 mm	<b>340-509-050</b>	<b>340-519-050</b>	<b>29-436-006</b>
	6 mm	<b>340-509-060</b>	<b>340-519-060</b>	

	1 mm	L = 180 mm <b>340-511-010</b>
tenká patka thin footplate	2 mm	<b>340-511-020</b>
	3 mm	<b>340-511-030</b>

	1 mm	L = 180 mm <b>340-513-010</b>
tenká patka thin footplate	2 mm	<b>340-513-020</b>
	3 mm	<b>340-513-030</b>



**CUSHING  
LOVE-GRUENWALD  
SPURLING**



**CUSHING**  
2 × 10 mm

délka ramene  
length of arm

13,0 cm  
15,0 cm  
18,0 cm  
20,0 cm  
25,0 cm  
30,0 cm

2 mm

**116 91 0428**  
**116 91 0434**  
**116 91 0440**  
**116 91 0446**  
**116 91 0449**  
**116 91 0452**

3 mm

**116 91 0430**  
**116 91 0436**  
**116 91 0442**  
**116 91 0447**  
**116 91 0450**  
**116 91 0453**

4 mm

**116 91 0432**  
**116 91 0438**  
**116 91 0444**  
**116 91 0448**  
**116 91 0451**  
**116 91 0454**

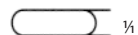

**LOVE-GRUENWALD**  
3 × 10 mm

délka ramene  
length of arm

13,0 cm  
15,0 cm  
18,0 cm  
20,0 cm  
25,0 cm  
30,0 cm

2 mm

**116 91 0455**  
**116 91 0458**  
**116 91 0461**  
**116 91 0464**  
**116 91 0467**  
**116 91 0470**

3 mm

**116 91 0456**  
**116 91 0459**  
**116 91 0462**  
**116 91 0465**  
**116 91 0468**  
**116 91 0471**

4 mm

**116 91 0457**  
**116 91 0460**  
**116 91 0463**  
**116 91 0466**  
**116 91 0469**  
**116 91 0472**



**SPURLING**  
4 × 10 mm

délka ramene  
length of arm

13,0 cm  
15,0 cm  
18,0 cm  
20,0 cm  
25,0 cm  
30,0 cm

2 mm

**116 91 0473**  
**116 91 0476**  
**116 91 0479**  
**116 91 0482**  
**116 91 0485**  
**116 91 0488**

3 mm

**116 91 0474**  
**116 91 0477**  
**116 91 0480**  
**116 91 0483**  
**116 91 0486**  
**116 91 0489**

4 mm

**116 91 0475**  
**116 91 0478**  
**116 91 0481**  
**116 91 0484**  
**116 91 0487**  
**116 91 0490**



**116 91 0491**  
2 × 3 mm



**116 91 0492**  
2 × 5 mm

**SELVERSTONE**  
délka ramene 15,0 cm  
length of arm 15.0 cm



**116 91 0493**  
2 × 10 mm



**116 91 0494**  
3 × 10 mm



**116 91 0495**  
4 × 10 mm

**SCHLESINGER**  
délka ramene 15,0 cm  
length of arm 15.0 cm



**116 91 0496**  
2 × 10 mm

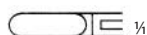

**116 91 0497**  
3 × 10 mm



**116 91 0498**  
4 × 10 mm

**CASPAR**  
délka ramene 15,0 cm  
length of arm 15.0 cm

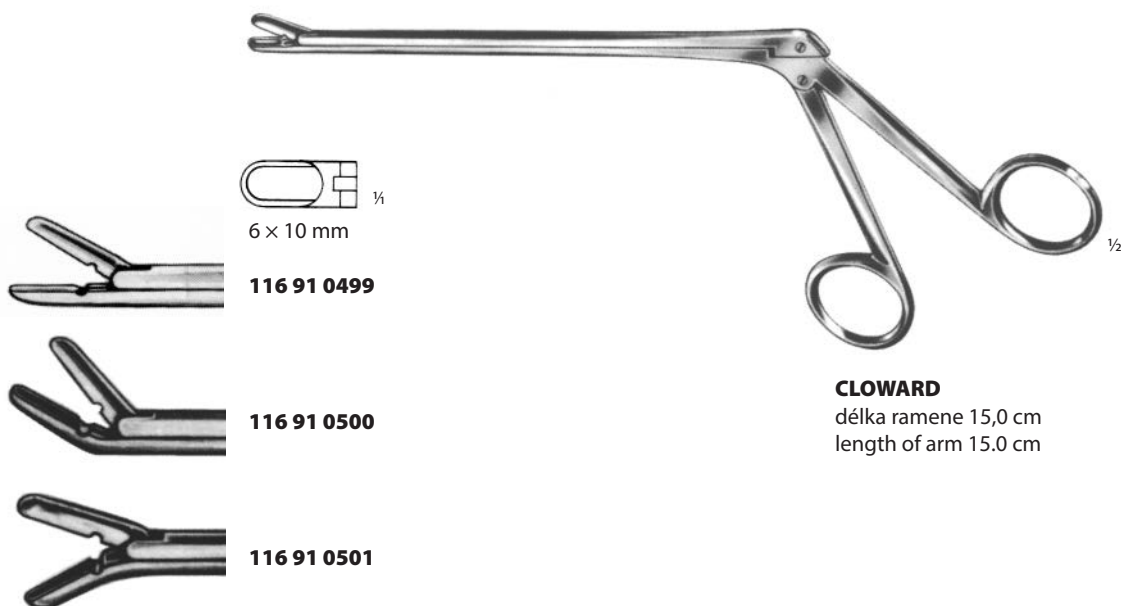
**CLOWARD**

délka ramene 15,0 cm  
length of arm 15.0 cm

**OLDBERG****116 91 0538**

délka ramene 18,0 cm  
length of arm 18.0 cm



**FERRIS-SMITH-CUSHING**

délka ramene 18,0 cm  
length of arm 18.0 cm

	2 × 10 mm		3 × 10 mm		4 × 10 mm		6 × 12 mm
	<b>116 91 0502</b>		<b>116 91 0505</b>		<b>116 91 0508</b>		<b>116 91 0511</b>
	<b>116 91 0503</b>		<b>116 91 0506</b>		<b>116 91 0509</b>		<b>116 91 0512</b>
	<b>116 91 0504</b>		<b>116 91 0507</b>		<b>116 91 0510</b>		<b>116 91 0513</b>

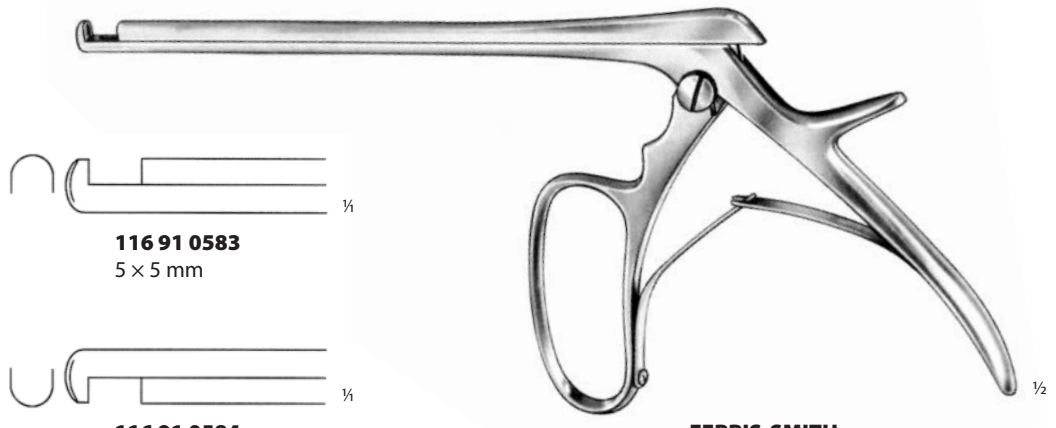

**FERRIS-SMITH**

délka ramene 18,0 cm  
length of arm 18.0 cm

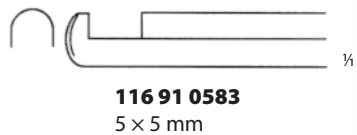

**116 91 0583**  
5 × 5 mm

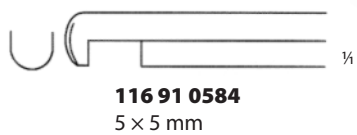

**116 91 0584**  
5 × 5 mm

KLEŠTĚ ŠTÍPACÍ NA LAMINEKTOMII  
LAMINECTOMY RONGEURS

**116 91 0585**  
4 × 4 mm

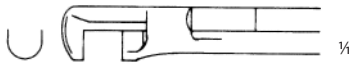

**116 91 0586**  
4 × 4 mm

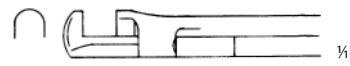

**116 91 0587**  
3,5 × 3,5 mm



**116 91 0588**  
3,5 × 3,5 mm



**HAJEK-KOFFLER**  
délka ramene 14,0 cm  
length of arm 14.0 cm

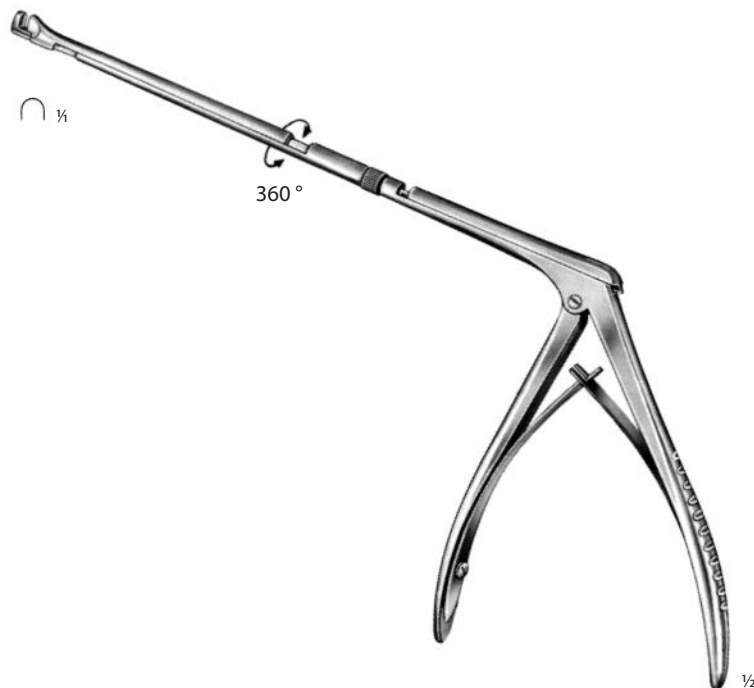

**HAJEK-KOFFLER**  
**116 91 0589**  
délka ramene 16,0 cm  
length of arm 16.0 cm



KLEŠTĚ ŠTÍPACÍ NA LAMINEKTOMII  
LAMINECTOMY RONGEURS

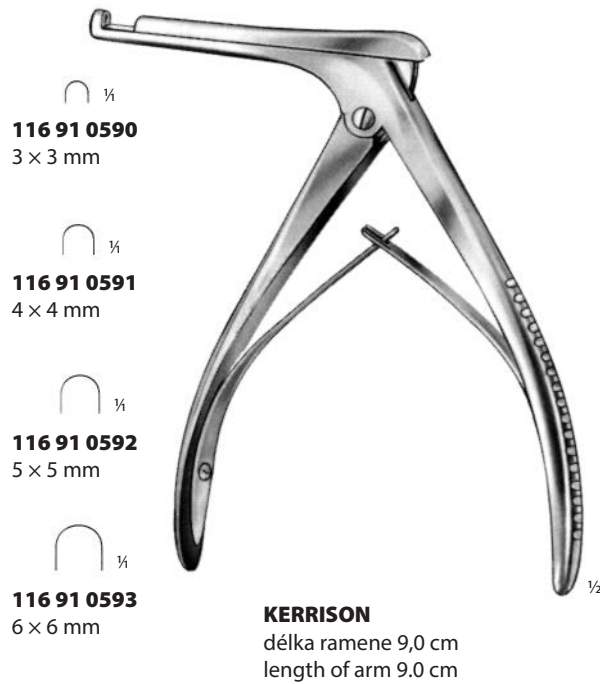

ŠTÍPÁKY NA LAMINEKTOMII  
LAMINECTOMY PUNCHES

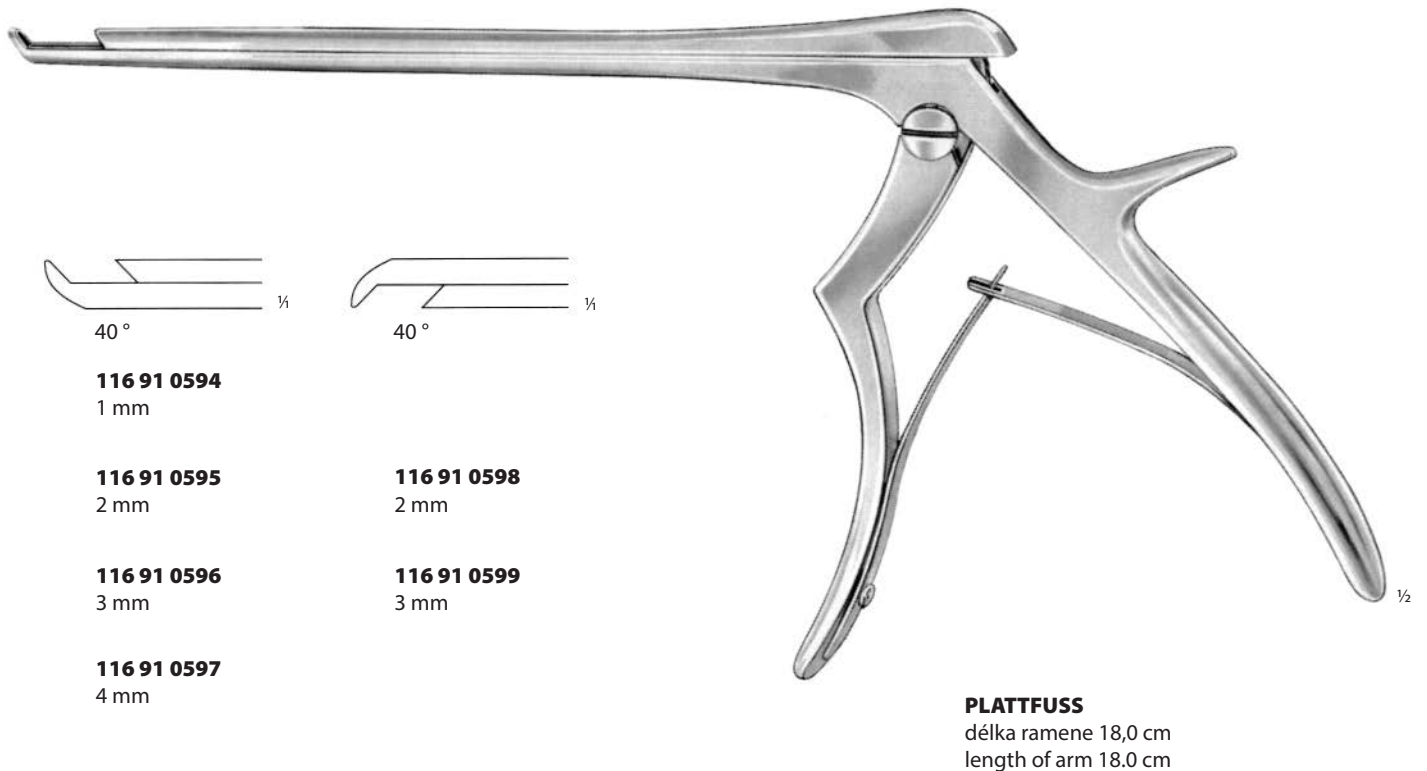

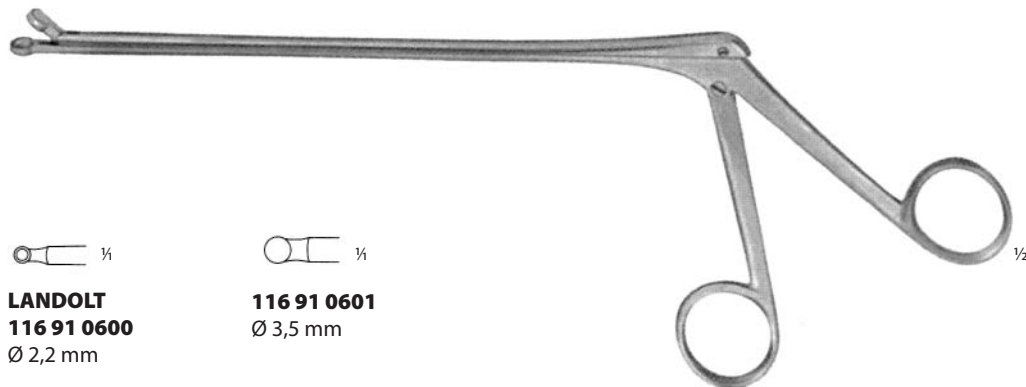

Nástroj pituitrální  
Pituitary instrument  
délka ramene 19,0 cm  
length of arm 19.0 cm

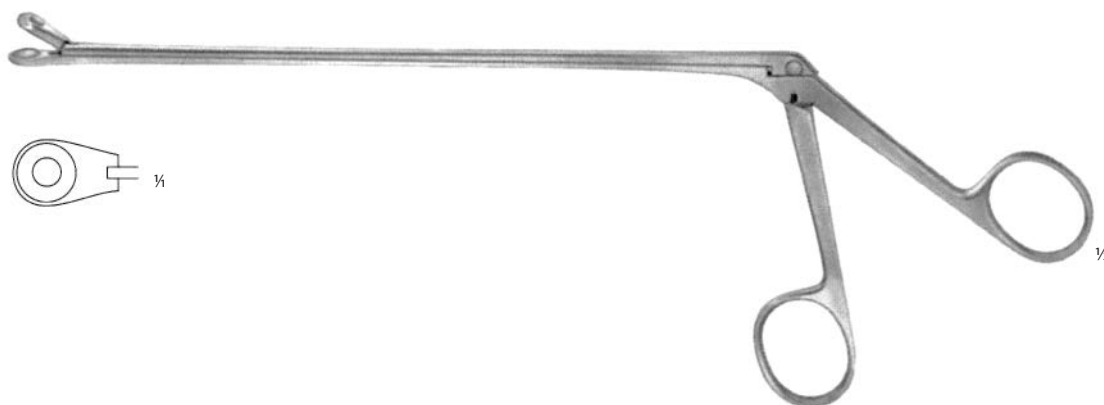



**DEVILBISS**  
**116 91 0561**  
21,0 cm



**DAHLGREEN**  
**116 91 0562**  
20,0 cm



**116 91 0563**  
horní – upper

**116 91 0564**  
pravé – right

**116 91 0565**  
levé – left

**BELLUCCI**  
**116 91 0563**  
délka ramene 8,0 cm  
length of arm 8.0 cm

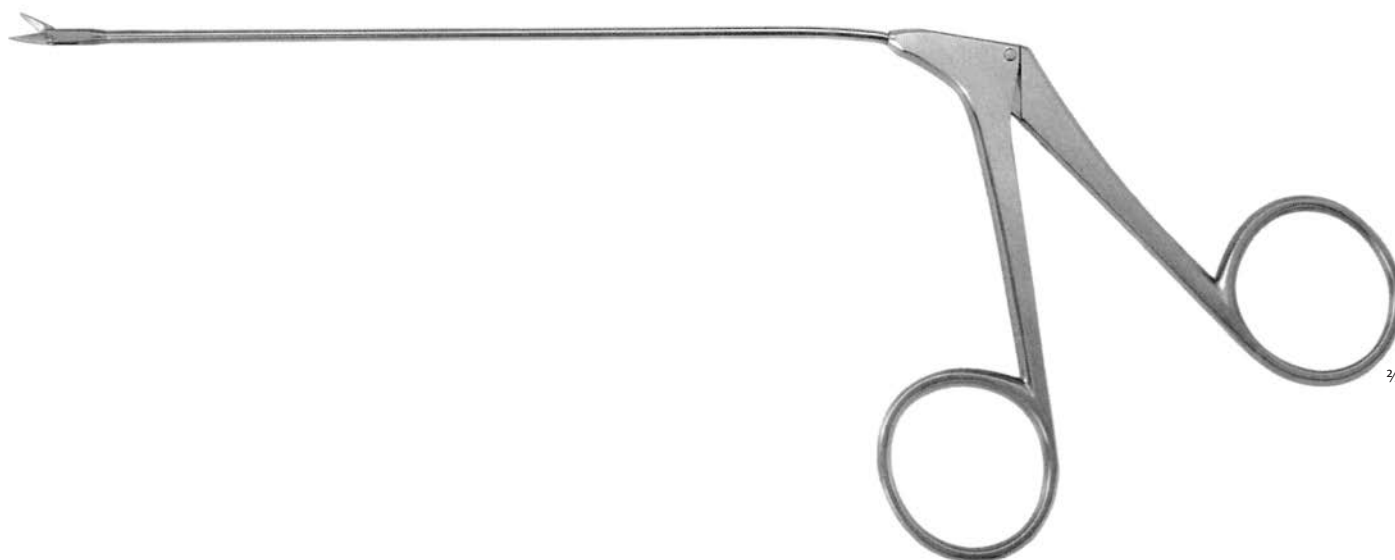

**FAHLBUSCH**  
**116 91 0566**  
délka ramene 16,5 cm  
length of arm 16.5 cm

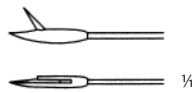
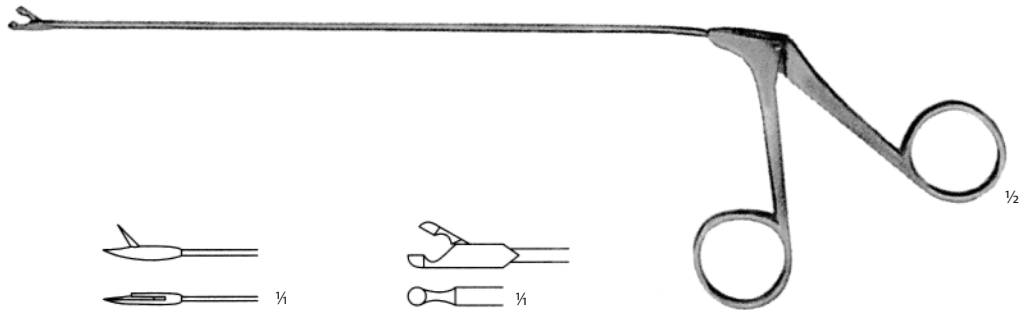

2 mm

**116 91 0567**  
horní – upper

**116 91 0568**  
horní – upper  
30°

**116 91 0569**  
pravé – right

**116 91 0570**  
levé – left

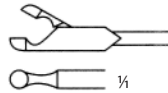

2 mm

**116 91 0571**  
horní – upper

**116 91 0572**  
horní – upper  
30°

**116 91 0573**  
pravé – right

**116 91 0574**  
levé – left

**NICOLA**

**116 91 0571**

délka ramene 20,0 cm  
length of arm 20.0 cm

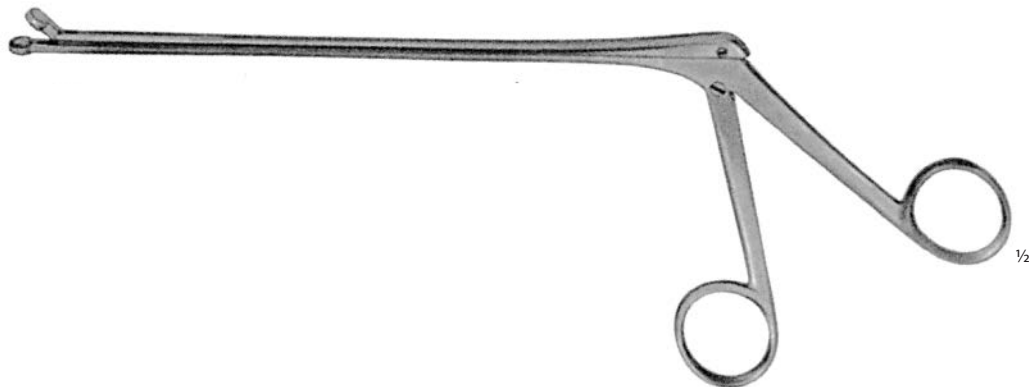

**116 91 0579**

délka ramene 18,0 cm  
length of arm 18.0 cm

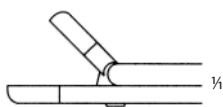

délka ramene – length of arm  
14,0 cm  
18,0 cm



3 mm  
**116 91 0575**  
**116 91 0579**



7 mm  
**116 91 0576**  
**116 91 0580**



9 mm  
**116 91 0577**  
**116 91 0581**

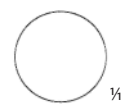

12 mm  
**116 91 0578**  
**116 91 0582**



Kleště zaváděcí  
Applying forceps  
16,0 cm

**117 91 0264**  
pro malé svorky  
for small clips  
16,0 cm

**117 91 0267**  
pro malé svorky  
for small clips  
20,0 cm



malá – small

**117 91 0270**  
balení – packing unit  
12 × 25 ks/pcs

**117 91 0271**  
balení – packing unit  
24 × 10 ks/pcs

**117 91 0265**  
pro střední svorky  
for medium clips  
16,0 cm

**117 91 0268**  
pro střední svorky  
for medium clips  
20,0 cm



střední – medium

**117 91 0272**  
balení – packing unit  
10 × 25 ks/pcs

**117 91 0273**  
balení – packing unit  
20 × 10 ks/pcs

**117 91 0266**  
pro středně velké svorky  
for medium large clips  
19,0 cm



středně velká – medium large

**117 91 0274**  
balení – packing unit  
16 × 10 ks/pcs



velká – large

**117 91 0275**  
balení – packing unit  
10 × 15 ks/pcs

**117 91 0276**  
balení – packing unit  
12 × 10 ks/pcs

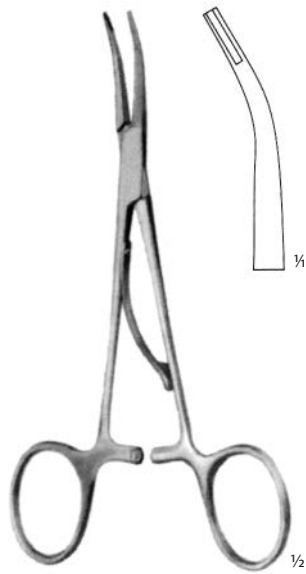

**McKENZIE**  
**117 91 0277**  
15,0 cm

**117 91 0278**  
19,0 cm

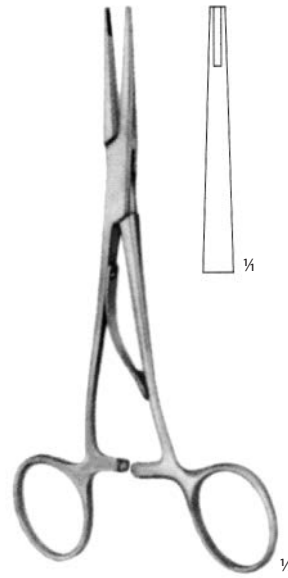

**McKENZIE**  
**117 91 0279**  
15,0 cm

**117 91 0280**  
19,0 cm



**OLIVERCRONA-TOENNIS**  
**(SCOVILLE)**  
**117 91 0281**  
délka ramene 14,0 cm  
length of arm 14.0 cm

**118 91 0350**31,0 cm  
Ø 7,0 mm**118 91 0351**41,0 cm  
Ø 9,0 mm



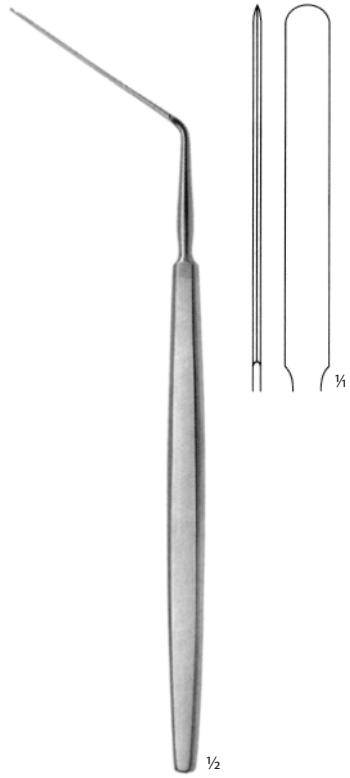

**HORSLEY**  
**118 91 0352**  
20,0 cm

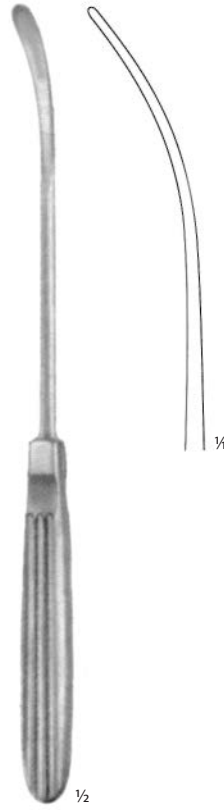

**SACHS**  
**118 91 0353**  
21,0 cm



**SCOVILLE**  
**118 91 0354**  
23,0 cm



**LOVE**  
**118 91 0355**  
přímý  
straight

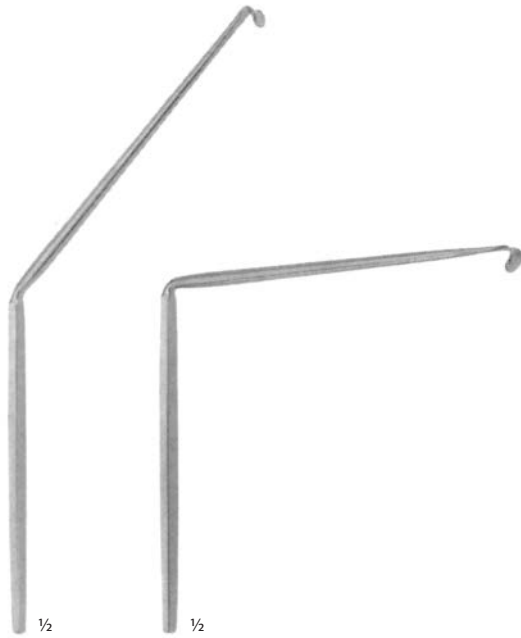

**LOVE**  
**118 91 0356**  
45°

**LOVE**  
**118 91 0357**  
90°



	L	koncovka tip
<b>118 91 0358</b>	7,0 cm	3,0 mm
<b>118 91 0359</b>	7,0 cm	5,0 mm
<b>118 91 0360</b>	7,0 cm	7,0 mm
<b>118 91 0361</b>	10,0 cm	3,0 mm
<b>118 91 0362</b>	10,0 cm	5,0 mm
<b>118 91 0363</b>	10,0 cm	7,0 mm

**LOVE MODIF.**

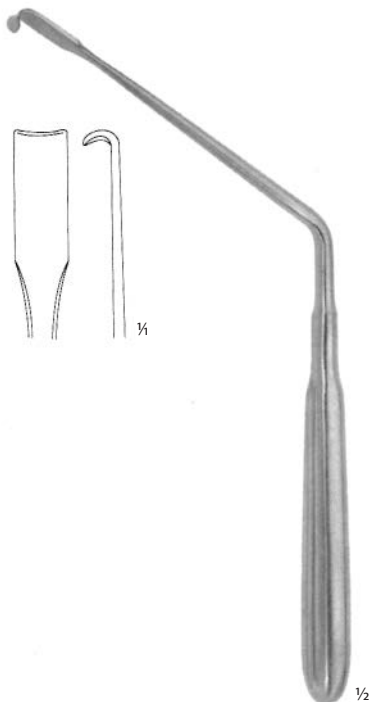

**118 91 0364**  
20,0 cm

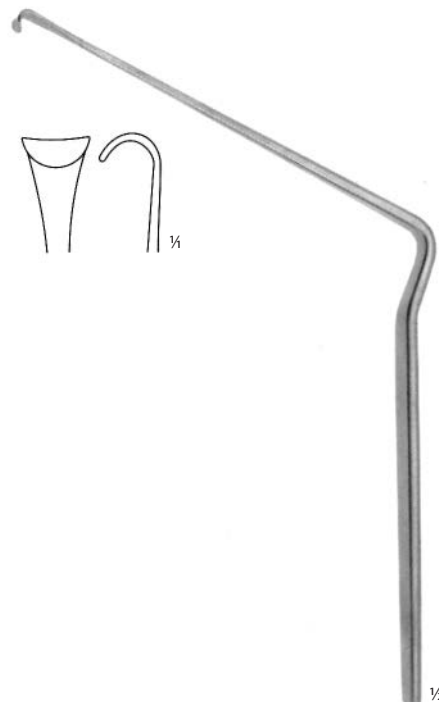

**118 91 0365**  
21,0 cm

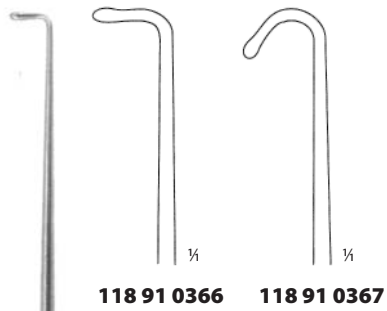

118 91 0366

118 91 0367

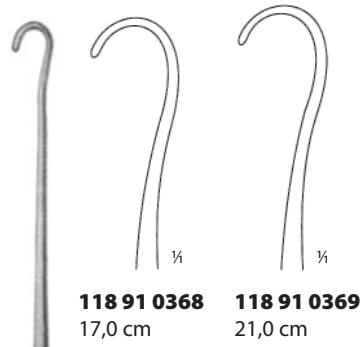

118 91 0368  
17,0 cm

118 91 0369  
21,0 cm

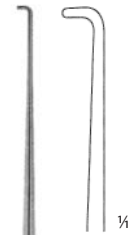

**GRONINGEN**  
26,0 cm

**SMITHWICK**

**DANDY**  
118 91 0370  
20,0 cm



**KRAYENBÜHL**  
18,5 cm

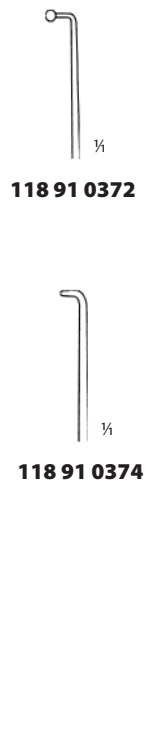

**BIEMER**  
118 91 0375  
16,0 cm



**FISH**  
118 91 0377  
18,5 cm

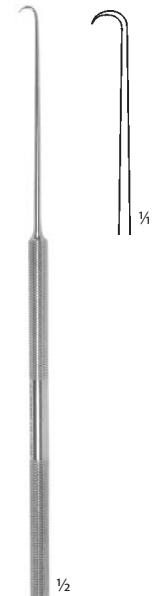

**118 17 0020**  
15,5 cm



**CASPAR**  
**118 91 0404**  
23,0 cm

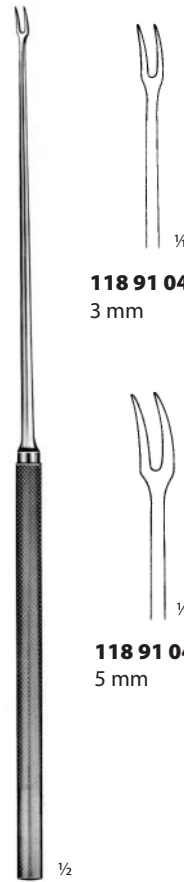

**OKONEK**  
23,0 cm

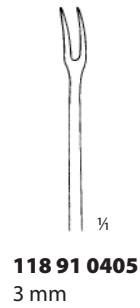

**118 91 0405**  
3 mm

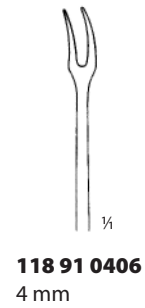

**118 91 0406**  
4 mm

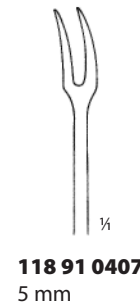

**118 91 0407**  
5 mm

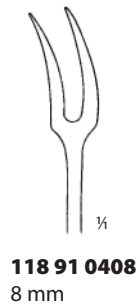

**118 91 0408**  
8 mm



**HEY**  
**119 91 0308**

**HEY**

**119 91 0307** = 1 × **119 91 0308**  
 1 × **119 91 0310**  
 1 × **119 91 0313**  
 1 × **119 91 0316**  
 1 × **119 91 0309**  
 1 × **119 91 0312**  
 1 × **119 91 0315**



20 × 50 mm

20 × 60 mm

20 × 70 mm

**119 91 0310****119 91 0313****119 91 0316****119 91 0311****119 91 0314****119 91 0317****119 91 0309**  
37 mm**119 91 0312**  
53 mm**119 91 0315**  
62 mm



**119 91 0319**  
 levý – left-type  
 17,0 cm



**119 91 0325**  
 pravý – right-type  
 17,0 cm

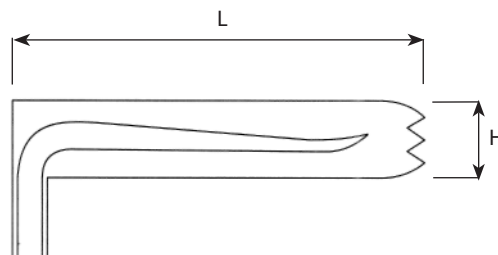

levý – left-type	pravý – right-type	L	H
<b>119 91 0318</b>	<b>119 91 0324</b>	50 mm	10 mm
<b>119 91 0320</b>	<b>119 91 0326</b>	60 mm	10 mm
<b>119 91 0322</b>	<b>119 91 0328</b>	70 mm	10 mm
<b>119 91 0319</b>	<b>119 91 0325</b>	50 mm	20 mm
<b>119 91 0321</b>	<b>119 91 0327</b>	60 mm	20 mm
<b>119 91 0323</b>	<b>119 91 0329</b>	70 mm	20 mm

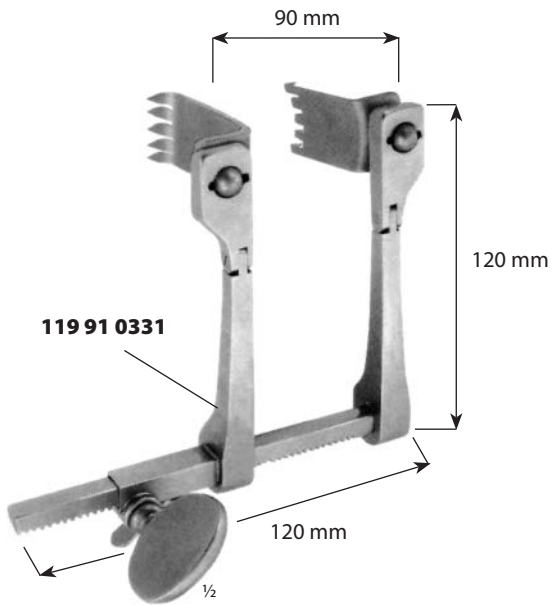

119 91 0331

120 mm

120 mm

1/2

**CASPAR**  
**119 91 0330**  
příčný – transversal

119 91 0330 = 1 × 119 91 0331  
1 × 119 91 0336  
1 × 119 91 0337  
1 × 119 91 0338  
1 × 119 91 0339  
1 × 119 91 0340  
1 × 119 91 0341  
1 × 119 91 0342  
1 × 119 91 0343  
1 × 119 91 0344  
1 × 119 91 0345



119 91 0335

165 mm

**CASPAR**  
**119 91 0334**

119 91 0334 = 1 × 119 91 0335  
1 × 119 91 0346  
1 × 119 91 0347  
1 × 119 91 0348  
1 × 119 91 0349  
1 × 119 91 0350

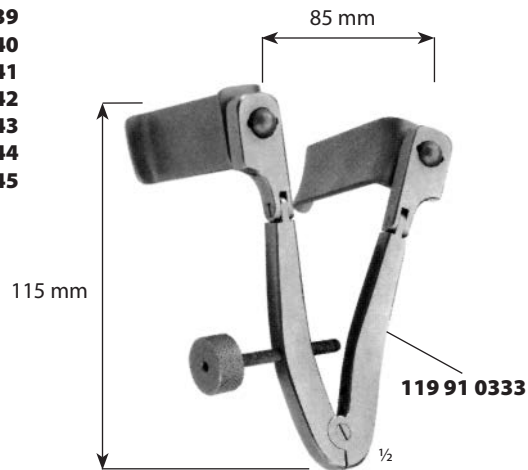

119 91 0333

115 mm

85 mm

1/2

**CASPAR**  
**119 91 0332**

119 91 0332 = 1 × 119 91 0333  
1 × 119 91 0346  
1 × 119 91 0347  
1 × 119 91 0348  
1 × 119 91 0349  
1 × 119 91 0350





**119 91 0336** 40 × 23 mm  
**119 91 0337** 45 × 23 mm  
**119 91 0338** 50 × 23 mm  
**119 91 0339** 55 × 23 mm  
**119 91 0340** 60 × 23 mm



**119 91 0341** 40 × 23 mm  
**119 91 0342** 45 × 23 mm  
**119 91 0343** 50 × 23 mm  
**119 91 0344** 55 × 23 mm  
**119 91 0345** 60 × 23 mm



**119 91 0346** 40 × 23 mm  
**119 91 0347** 45 × 23 mm  
**119 91 0348** 50 × 23 mm  
**119 91 0349** 55 × 23 mm  
**119 91 0350** 60 × 23 mm



**119 91 0351** 50 × 25 mm  
**119 91 0352** 60 × 25 mm



**119 91 0353**  
11,5 cm

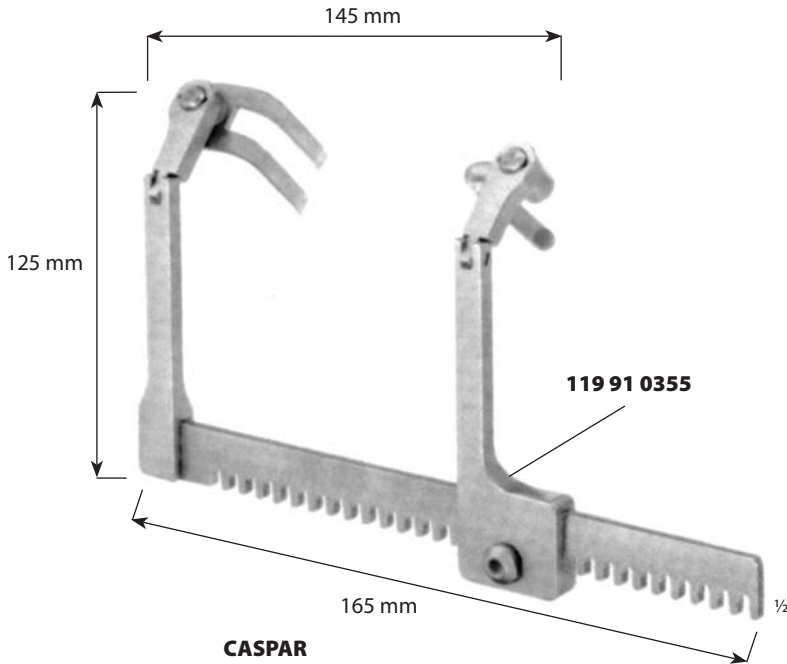

**CASPAR**  
**119 91 0354**



**119 91 0356**

- 119 91 0354** = 1 × **119 91 0355**  
 1 × **119 91 0356**  
 1 × **119 91 0360**  
 1 × **119 91 0361**  
 1 × **119 91 0362**  
 1 × **119 91 0363**  
 1 × **119 91 0364**



**119 91 0357**  
38 mm

**119 91 0358**  
58 mm

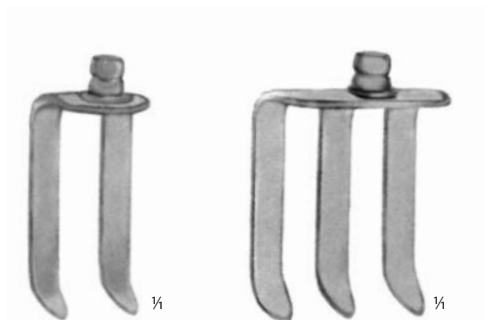

22 mm

37 mm

- 119 91 0359**  
**119 91 0360**  
**119 91 0361**  
**119 91 0362**  
**119 91 0363**  
**119 91 0364**  
**119 91 0365**  
**119 91 0366**

- 119 91 0367**  
**119 91 0368**  
**119 91 0369**  
**119 91 0370**  
**119 91 0371**  
**119 91 0372**  
**119 91 0373**  
**119 91 0374**

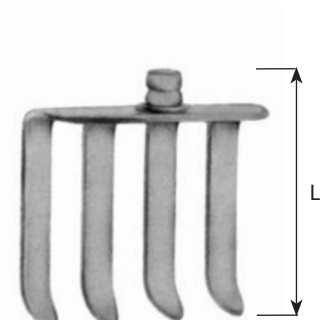

52 mm

- 119 91 0375** 32 mm  
**119 91 0376** 37 mm  
**119 91 0377** 43 mm  
**119 91 0378** 47 mm  
**119 91 0379** 52 mm  
**119 91 0380** 57 mm  
**119 91 0381** 62 mm  
**119 91 0382** 67 mm

**CASPAR**

	L
<b>119 91 0383</b>	40 mm
<b>119 91 0384</b>	45 mm
<b>119 91 0385</b>	50 mm
<b>119 91 0386</b>	55 mm
<b>119 91 0387</b>	60 mm

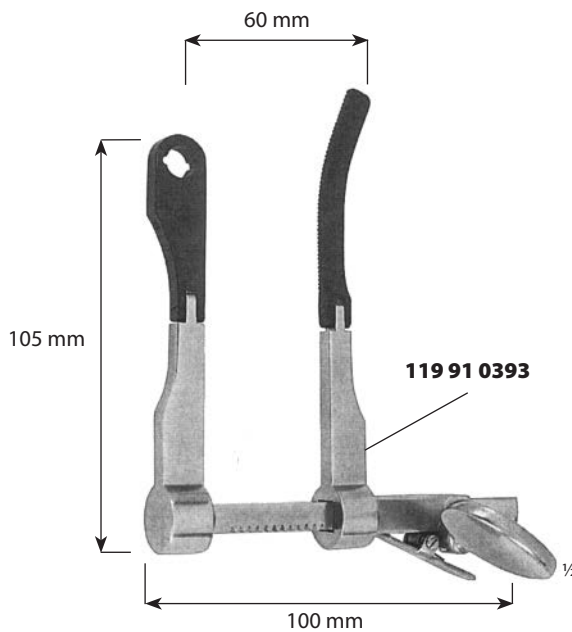
**CASPAR**  
**119 91 0392**

<b>119 91 0392</b>	=	1 × <b>119 91 0393</b>
		1 × <b>119 91 0394</b>
		1 × <b>119 91 0395</b>
		1 × <b>119 91 0396</b>
		1 × <b>119 91 0397</b>
		1 × <b>119 91 0398</b>
		1 × <b>119 91 0399</b>

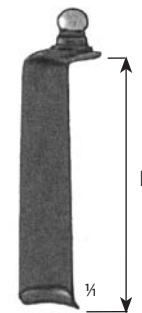

	L
<b>119 91 0394</b>	35 mm
<b>119 91 0395</b>	40 mm
<b>119 91 0396</b>	45 mm
<b>119 91 0397</b>	50 mm
<b>119 91 0398</b>	55 mm
<b>119 91 0399</b>	60 mm

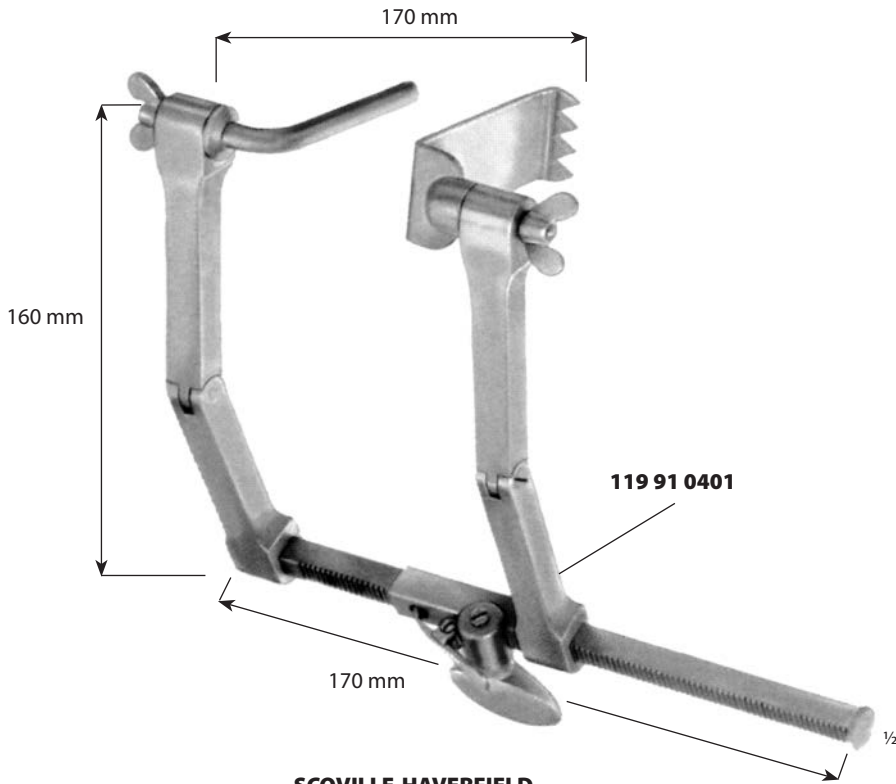

**SCOVILLE-HAVERFIELD**  
**119 91 0400**

- 119 91 0400** = 1 × **119 91 0401**  
 1 × **119 91 0402**  
 1 × **119 91 0403**



**SCOVILLE**  
**119 91 0402**  
5,5 cm



**SCOVILLE**  
**119 91 0403** 63 × 25 mm  
**119 91 0404** 63 × 51 mm  
**119 91 0405** 67 × 32 mm  
**119 91 0406** 89 × 25 mm



**TAYLOR**  
**119 91 0407**  
47 × 37 mm



**TAYLOR**  
**119 91 0408**  
63 × 51 mm

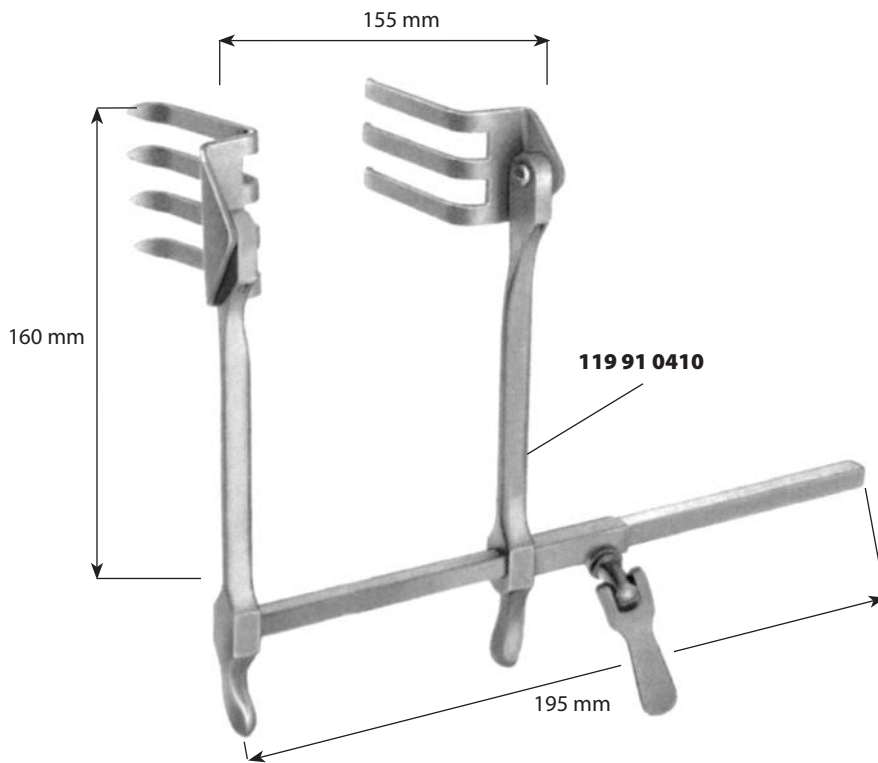

**SCOVILLE-RICHTER**  
**119 91 0409**

**119 91 0409** = 1 × **119 91 0410**  
1 × **119 91 0411**



**119 91 0411**  
pár – pair  
62 × 52 mm



**119 91 0412**  
62 × 37 mm



**119 91 0413**  
47 × 51 mm



**119 91 0414**  
30 × 40 mm

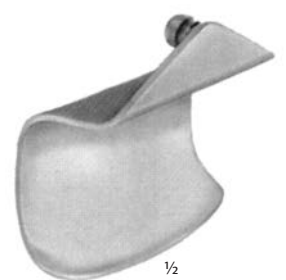

**119 91 0415**  
37 × 62 mm



**CLOWARD MODIF.**  
**119 91 0415**  
25,0 cm

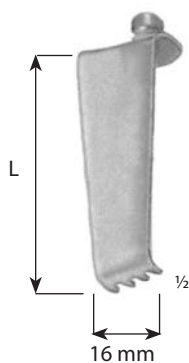

- |                    |       |
|--------------------|-------|
| <b>119 91 0417</b> | 40 mm |
| <b>119 91 0418</b> | 45 mm |
| <b>119 91 0419</b> | 50 mm |
| <b>119 91 0420</b> | 55 mm |
| <b>119 91 0421</b> | 60 mm |

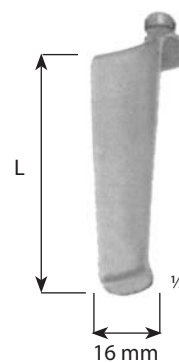

- |                    |       |
|--------------------|-------|
| <b>119 91 0422</b> | 40 mm |
| <b>119 91 0423</b> | 45 mm |
| <b>119 91 0424</b> | 50 mm |
| <b>119 91 0425</b> | 55 mm |
| <b>119 91 0426</b> | 60 mm |

- 119 91 0415** = 1 × **119 91 0416**  
 1 × **119 91 0417**  
 1 × **119 91 0418**  
 1 × **119 91 0419**  
 1 × **119 91 0420**  
 1 × **119 91 0421**

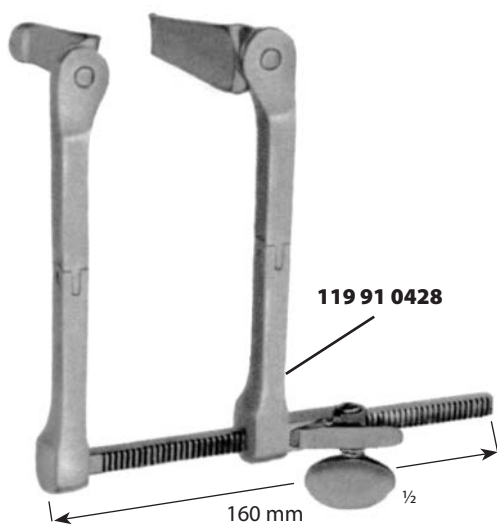

**119 91 0427**  
25,0 cm

- 119 91 0427** = 1 × **119 91 0428**  
 1 × **119 91 0417**  
 1 × **119 91 0418**  
 1 × **119 91 0419**  
 1 × **119 91 0420**  
 1 × **119 91 0421**

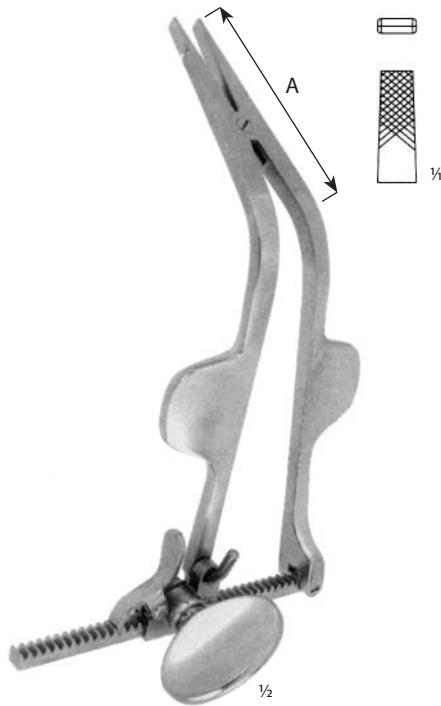

**CLOWARD**  
**119 91 0429**

A  
**119 91 0429** 50 mm  
**119 91 0430** 75 mm

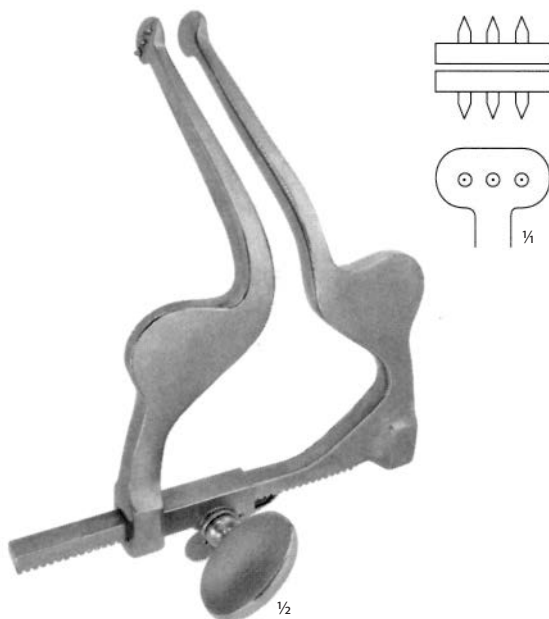

**CLOWARD**  
**119 91 0431** 90 mm  
**119 91 0432** 110 mm

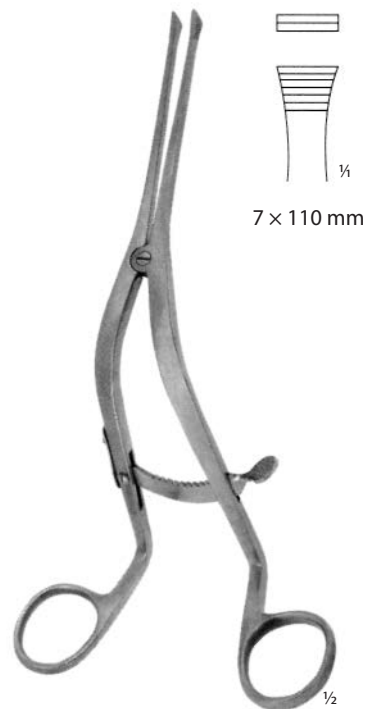

**CLOWARD**  
**119 91 0433**  
 21,0 cm



**HARMS**  
**119 91 0434**  
18,0 cm



**HARMS**  
**119 91 0435**  
18,0 cm



**CLOWARD**  
**119 91 0436**  
16,0 cm



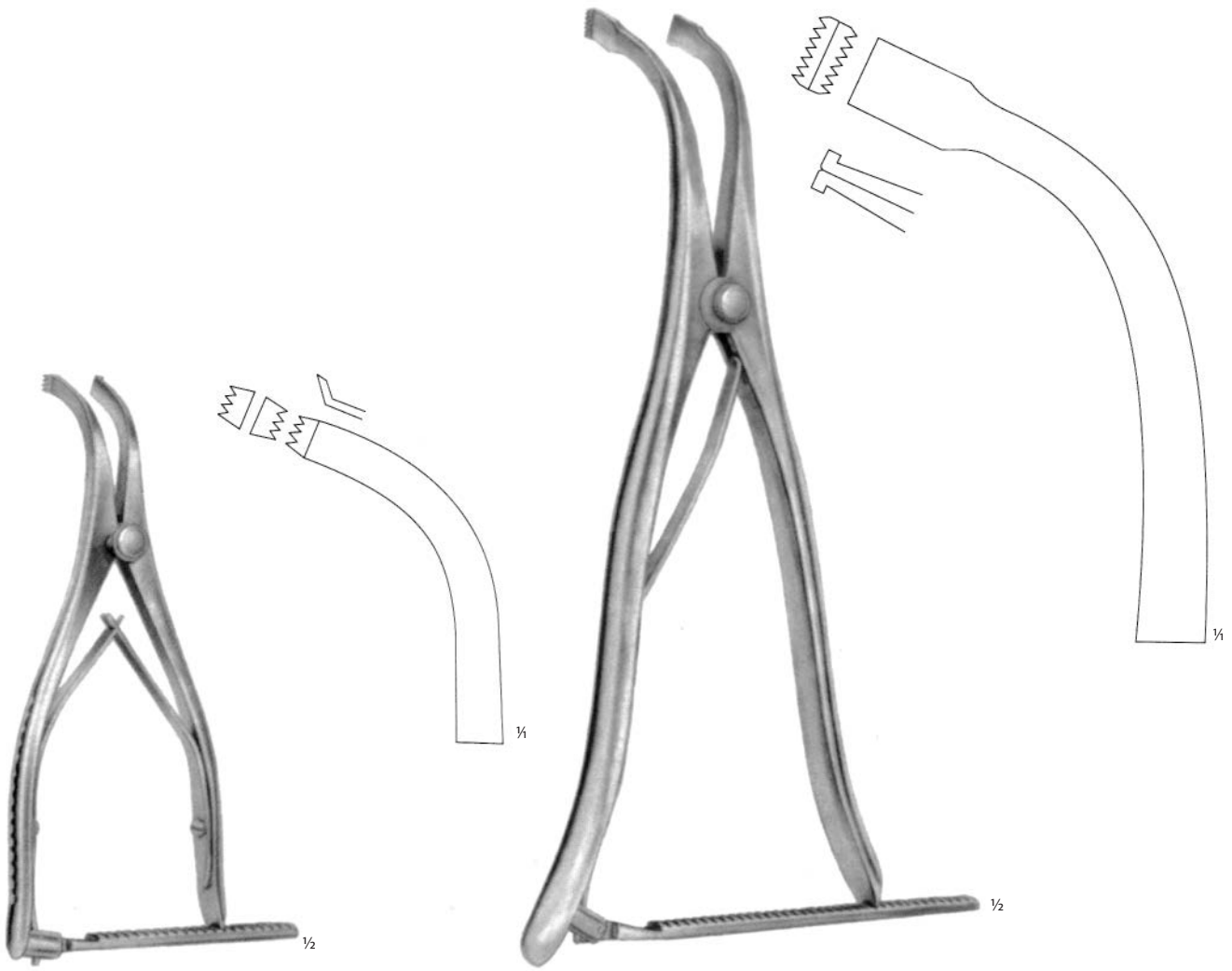

**INGE**  
**119 91 0437**  
16,5 cm

**INGE**  
**119 91 0438**  
27,0 cm

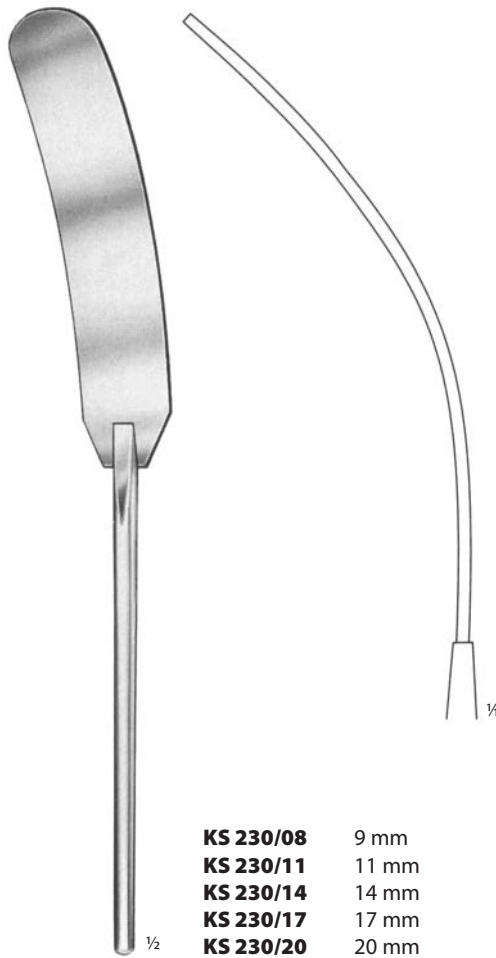

- KS 230/08** 9 mm
- KS 230/11** 11 mm
- KS 230/14** 14 mm
- KS 230/17** 17 mm
- KS 230/20** 20 mm



- KS 237/12** 12 mm
- KS 237/17** 17 mm

**HEIFETZ**  
ohebná – malleable  
20,0 cm

Lopatka mozková  
Brain spatula  
ohebná – malleable  
20,0 cm

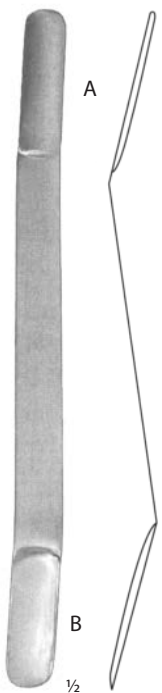

- |                    |       |       |
|--------------------|-------|-------|
| vydutá<br>concave  | A     | B     |
| <b>KS 232/01</b>   | 7 mm  | 9 mm  |
| <b>KS 232/02</b>   | 11 mm | 13 mm |
| <b>KS 232/03</b>   | 15 mm | 18 mm |
| <b>KS 232/04</b>   | 18 mm | 22 mm |
| vypouklá<br>convex | A     | B     |
| <b>KS 233/01</b>   | 7 mm  | 9 mm  |
| <b>KS 233/02</b>   | 11 mm | 13 mm |
| <b>KS 233/03</b>   | 15 mm | 18 mm |
| <b>KS 233/04</b>   | 18 mm | 22 mm |



- |                  |       |       |
|------------------|-------|-------|
|                  | A     | B     |
| <b>KS 236/01</b> | 7 mm  | 9 mm  |
| <b>KS 236/02</b> | 11 mm | 13 mm |
| <b>KS 236/03</b> | 15 mm | 18 mm |
| <b>KS 236/04</b> | 18 mm | 22 mm |

**OLIVERCRONA**  
18,0 cm

Lopatka mozková  
Brain spatula  
ohebná – malleable  
18,0 cm

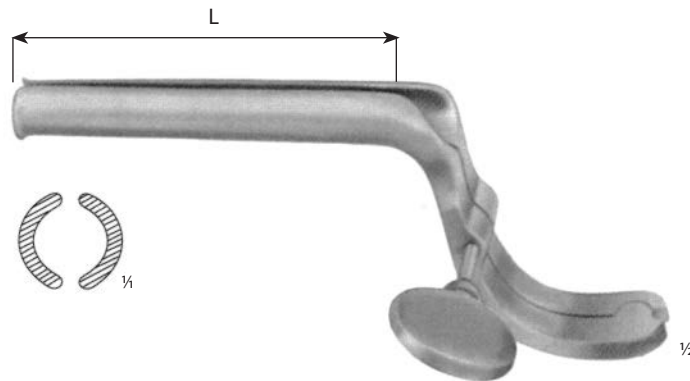

**CUSHING-LANDOLT**

L

**KS 820/01** 70 × 15 mm

**KS 820/02** 90 × 15 mm

**KS 820/03** 110 × 15 mm



**LANDOLT**  
**KS 821/21**  
21,5 cm

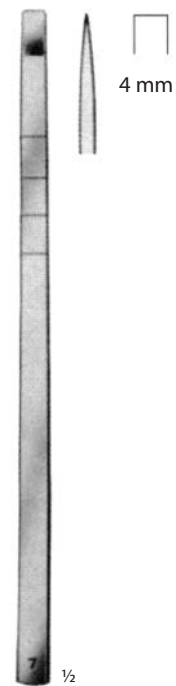

**COTTLE**  
**KS 822/04**  
18,0 cm  
4 mm

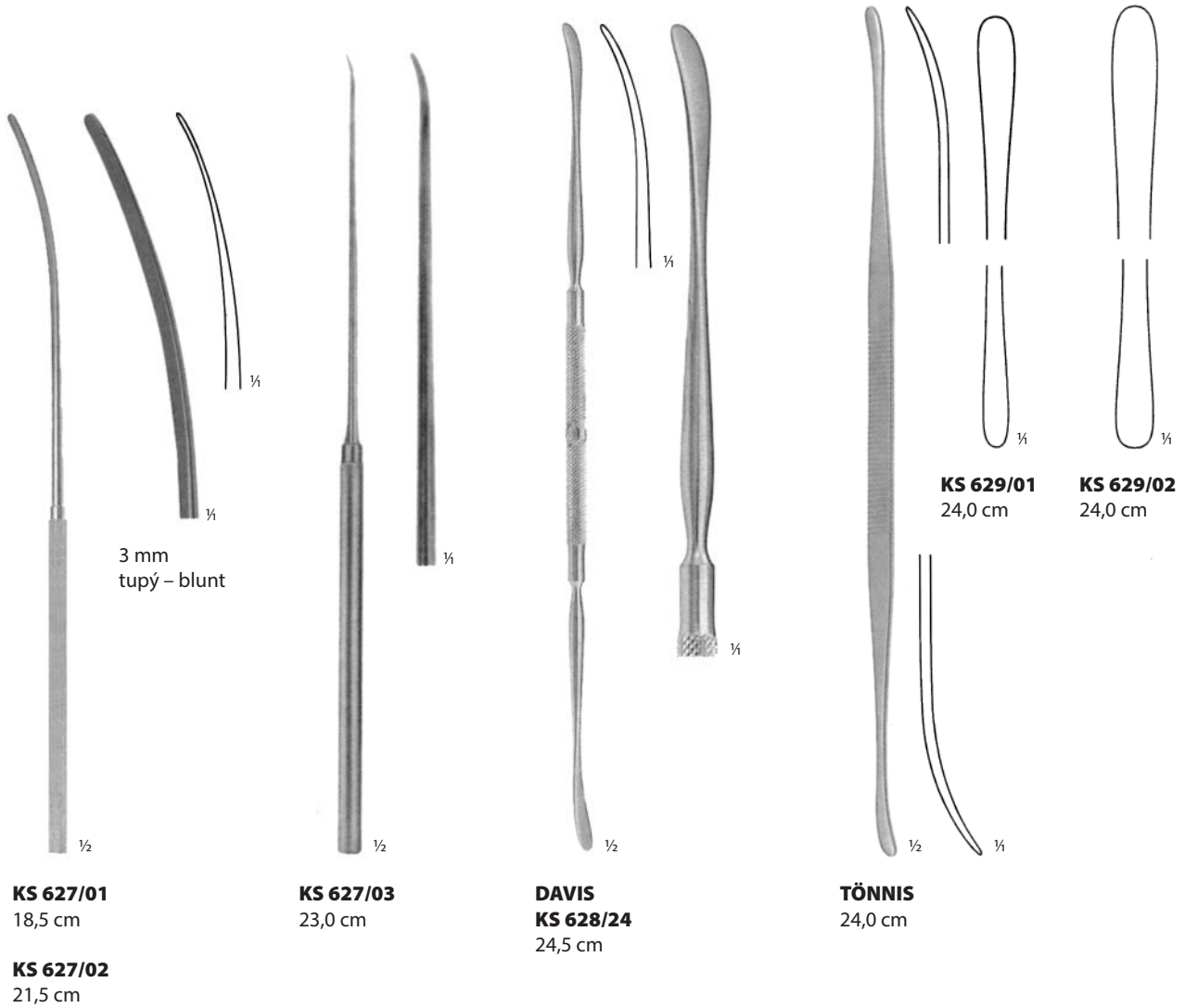



**SACHS  
KS 631/21**  
21,0 cm



**SACHS  
KS 632/21**  
21,0 cm



**FRAZIER  
KS 633/01**  
15,0 cm



**HOEN  
KS 633/02**  
15,0 cm



**HOEN  
KS 633/03**  
15,0 cm

UVOLŇOVAČE TVRDÉ PLENY MOZKOVÉ  
DURA DISSECTORS

1/2

**OLIVERCRONA**  
24,0 cm

1/4

**KS 634/18**  
18,0 cm**KS 634/24**  
24,0 cm

1/4

**KS 635/20**  
19,5 cm**KS 635/24**  
24,0 cm

1/4



1/4

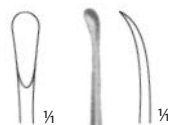

1/4

1/4



1/4



1/2

**MILLIGAN**  
**KS 636/21**  
21,0 cm

1/2

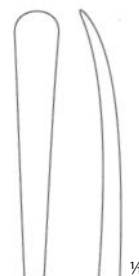
**KS 637/22**  
22,0 cm

1/4



1/4



1/4



**PENFIELD  
KS 638/01**  
17,5 cm



**PENFIELD  
KS 638/02**  
19,5 cm



**PENFIELD  
KS 638/03**  
19,5 cm



**PENFIELD  
KS 638/04**  
20,5 cm



**PENFIELD  
KS 638/05**  
29,0 cm

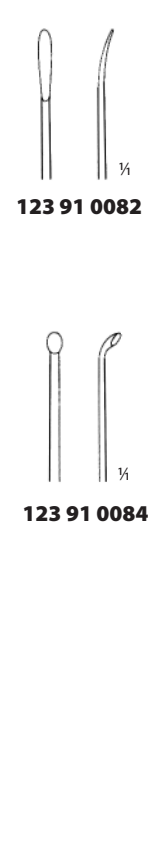
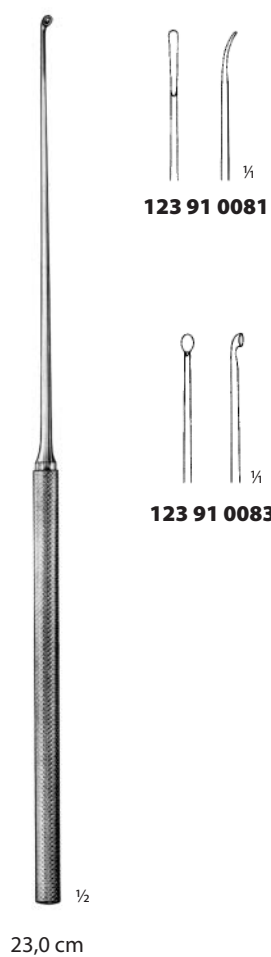
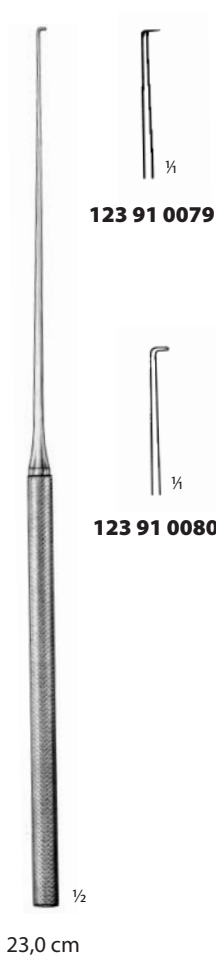



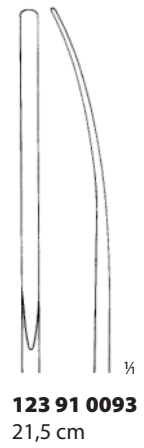
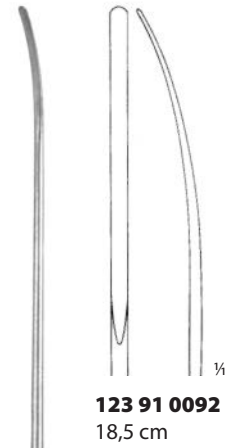
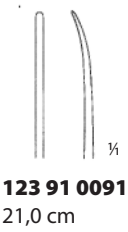
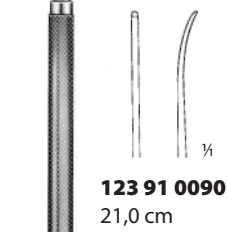
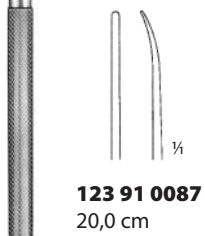
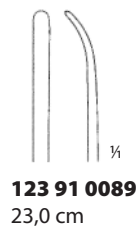
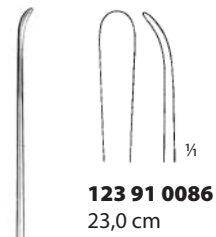

CASPAR

CASPAR

**123 91 0093**  
21,5 cm



CASPAR

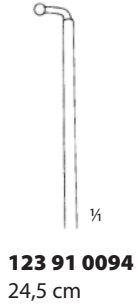

**123 91 0094**  
24,5 cm

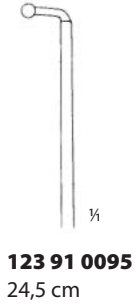

**123 91 0095**  
24,5 cm

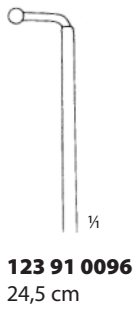

**123 91 0096**  
24,5 cm

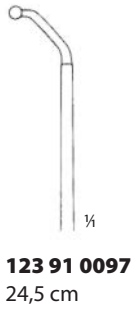

**123 91 0097**  
24,5 cm



SAMII

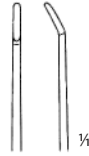

**123 91 0098**  
20,0 cm

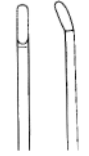

**123 91 0099**  
20,0 cm



**123 91 0100**  
20,0 cm

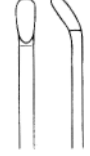

**123 91 0101**  
20,0 cm



**123 91 0106**  
23,0 cm



**123 91 0107**  
23,0 cm



**123 91 0108**  
23,0 cm



**123 91 0109**  
23,0 cm



**123 91 0102**  
20,0 cm



**123 91 0103**  
20,0 cm



**123 91 0104**  
20,0 cm



**123 91 0105**  
20,0 cm



**123 91 0110**  
23,0 cm



**123 91 0111**  
23,0 cm



**123 91 0112**  
23,0 cm



**123 91 0113**  
23,0 cm

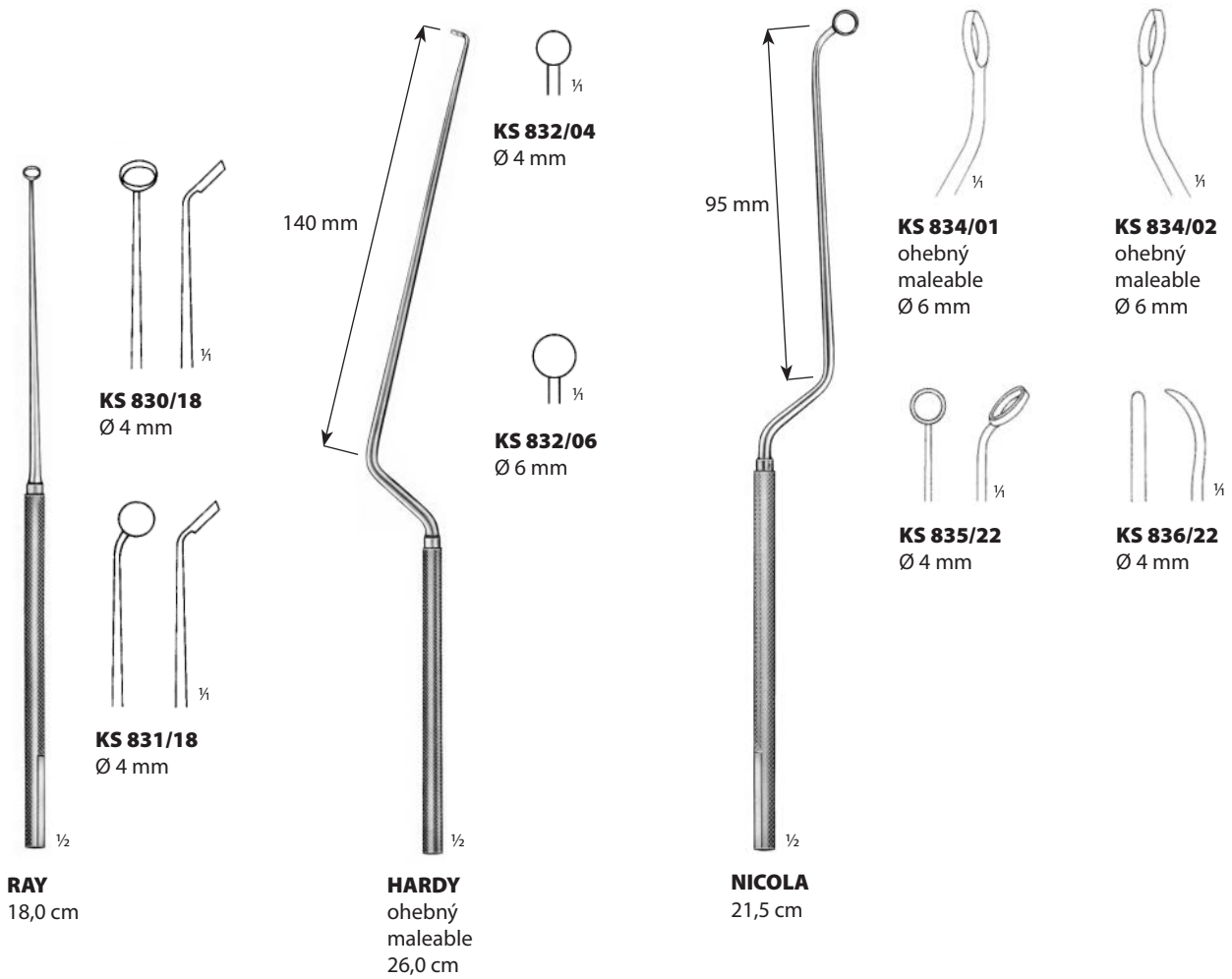

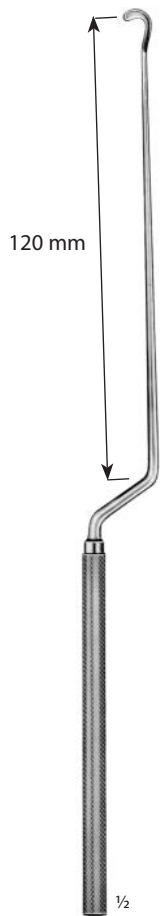

**HARDY**  
26,0 cm



**HARDY**  
**KS 837/01**  
tupý  
blunt



**HARDY**  
**KS 837/02**  
tupý  
blunt



**HARDY**  
**KS 837/03**  
ostrý  
sharp



**HARDY**  
**KS 837/04**  
ostrý  
sharp



**HARDY**  
**KS 838/25**



**HARDY-FAHLBUSCH**  
**KS 839/01**  
ostrý  
sharp



**HARDY-FAHLBUSCH**  
**KS 839/02**  
ostrý  
sharp

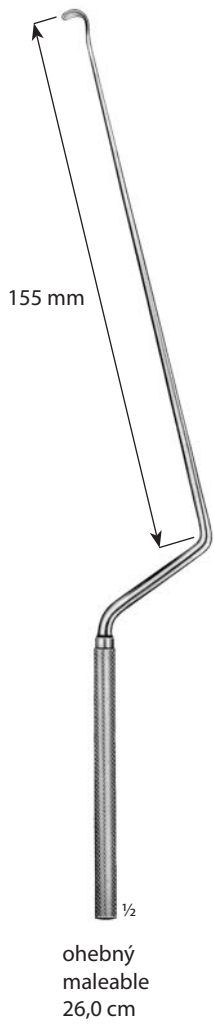

**LANDOLT**  
**KS 840/01**



**LANDOLT**  
**KS 840/02**

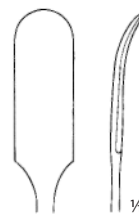

**LANDOLT**  
**KS 841/26**

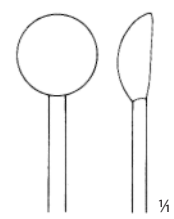

**LANDOLT**  
**KS 842/26**



**HARDY**  
**KS 843/26**



**FAHLBUSCH**  
**KS 844/26**

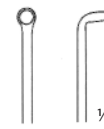

**FAHLBUSCH**  
**KS 845/26**

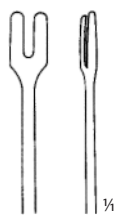
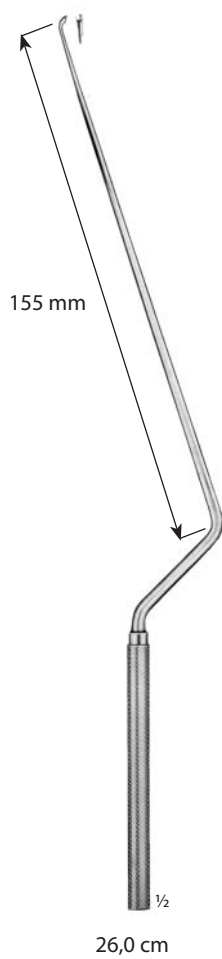

**HOSOBUCHI**  
**KS 846/26**

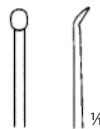

**LANDOLT-REULEN**  
**KS 847/22**  
Ø 2,2 mm

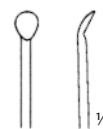

**LANDOLT-REULEN**  
**KS 847/32**  
Ø 3,2 mm

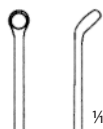

**LANDOLT-REULEN**  
**KS 848/25**  
Ø 2,5 mm



**LANDOLT-REULEN**  
**KS 849/17**  
1,7 mm

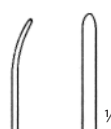

**LANDOLT-REULEN**  
**KS 850/20**  
2 mm



**OLIVECRONE**  
**127 17 0011**  
32,0 cm  
balení 10 ks  
packing 10 pcs

**OLIVECRONE**  
**127 17 0021**  
40,0 cm  
balení 10 ks  
packing 10 pcs



Držátko drátěných pilek  
Hook handle for saws  
**127 17 0051**  
pár  
couple  
8,0 cm



Original 33,0 cm

Zavaděč drátěných pilek  
Conductor for wire saws  
**133 17 0061**  
33,0 cm

**133 17 0070**  
25,0 cm

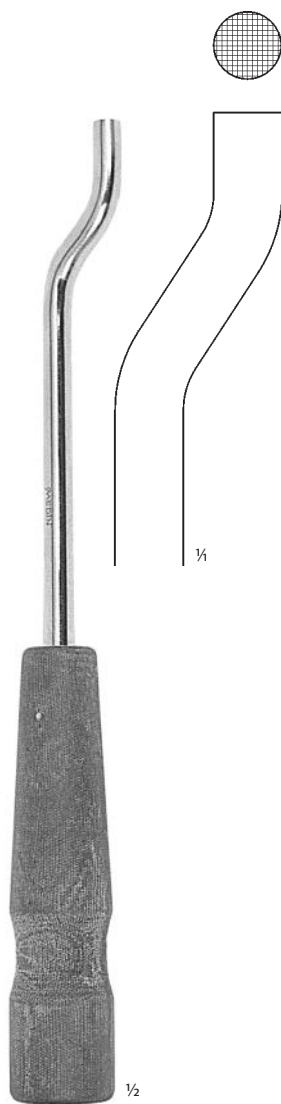

Naražeč kostních štěpů  
Bone graft driver  
**128 09 0030**  
26,0 cm



Zatloukač kostních štěpů  
Bone graft driver  
**128 09 0040**  
21,0 cm  
Ø 9 mm

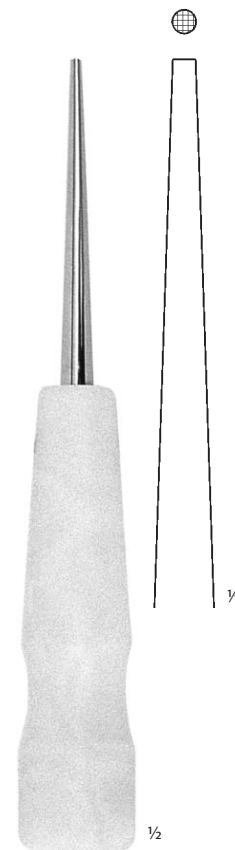

Zatloukač  
Punch  
**128 99 0015**  
21,0 cm  
Ø 1,5 mm

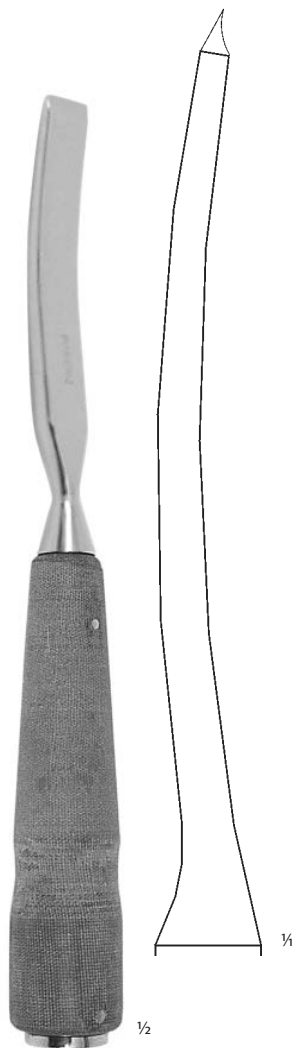

DLÁTO ORTOPEDICKÉ, DLÁTA NEUROCHIRURGICKÁ LISTOVÁ  
ORTHOPAEDIC GOUGE, NEUROSURGICAL LEAF OSTEOTOMES

Dláto ortopedické  
Orthopaedic gouge  
**128 09 0200**  
25,0 cm  
16 mm

original 40 mm

**LAMBOTTE**

	A	B
<b>128 99 0031</b>	18,0 cm	10 mm
<b>128 99 0032</b>	18,0 cm	15 mm
<b>128 99 0033</b>	18,0 cm	20 mm
<b>128 99 0035</b>	18,0 cm	25 mm
<b>128 99 0036</b>	18,0 cm	30 mm
<b>128 99 0038</b>	18,0 cm	40 mm

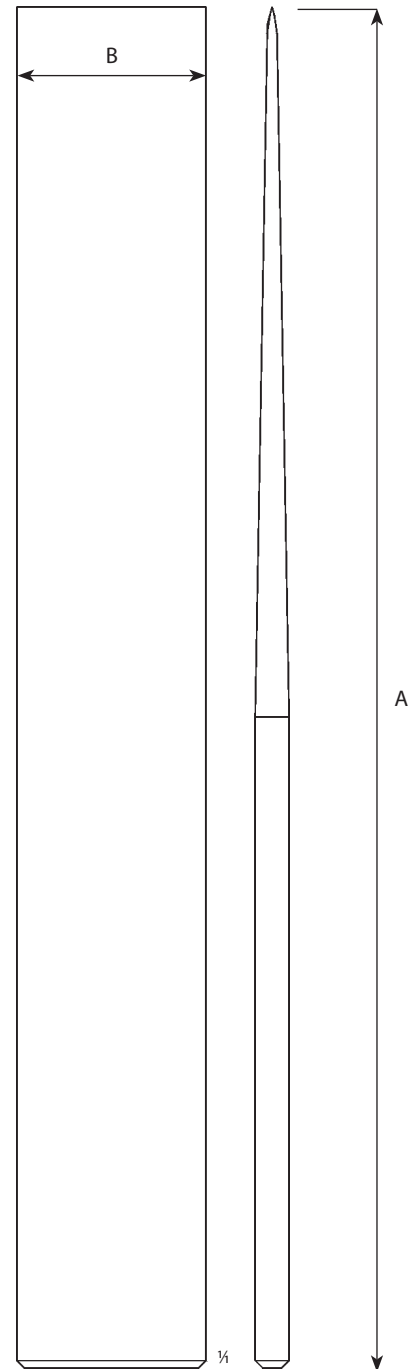



číslo – number	název	item	strana – page
00-21010-71	Adaptér k optice Olympus/RFQ/Storz/Aesculap	Adapter instrument side Olympus/RFQ/Storz/Aesculap	364
00-21110-66	Adaptér ke sv. zdroji ACM / British	Adapter projector side ACM / British	364
00-21110-70	Adaptér ke sv.zdroji RFQ/Storz/Wisap/Aesculap	Adapter projector side RFQ/Storz/Wisap/Aesculap	364
00-21110-72	Adaptér ke sv. zdroji Winter & Ibe	Adapter projector side Winter & Ibe	364
00-21110-74	Adaptér ke sv.zdroji Wolf/HSW/Dyonics/Medicon	Adapter projector side Wolf/HSW/Dyonics/Medicon	364
00-21113-03	Adaptér ke sv. zdroji Heine Optotechnik	Adapter projector side Heine Optotechnik	364
00-21113-06	Adaptér ke sv. zdroji Schott/Zeiss(Kolposkop)	Adapter projector side Schott/Zeiss(Kolposkop)	364
00-21113-07	Adaptér ke sv. zdroji Zeiss (OP Microscop)	Adapter projector side Zeiss (OP Microscop)	364
00-21116-62	Adaptér ke sv. zdroji Olympus/ACMI	Adapter projector side Olympus/ACMI	364
00-21116-63	Adaptér ke sv. zdroji Olymp./ACMI spec. model	Adapter projector side Olymp./ACMI spec. model	364
00-21119-60	Adaptér ke sv. zdroji Volpi/Fot/Schölly	Adapter projector side Volpi/Fot/Schölly	364
00-21119-62	Adaptér ke sv. zdroji Fuji	Adapter projector side Fuji	364
00-21119-65	Adaptér ke sv. zdroji Pentax	Adapter projector side Pentax	364
00-21360-00	Lampa čelní pro světlovdný kabel	Headlamp fiber optic deluxe	364
00-22330-30CE	Světlovdný kabel HP 3,5*1800 mm HTT* červený	HTT fiber optic cable BlueLine 3.5*1800 mm red	364
00-22330-30MO	Světlovdný kabel HP 3,5*1800 mm HTT* modrý	HTT fiber optic cable BlueLine 3.5*1800 mm blue	364
00-22330-30OR	Světlovdný kabel HP 3,5*1800 mm HTT* oranžový	HTT fiber optic cable BlueLine 3.5*1800 mm orange	364
00-22330-30SE	Světlovdný kabel HP 3,5*1800 mm HTT* šedivý	HTT fiber optic cable BlueLine 3.5*1800 mm grey	364
00-22330-30ZE	Světlovdný kabel HP 3,5*1800 mm HTT* zelený	HTT fiber optic cable BlueLine 3.5*1800 mm green	364
00-22330-30ZL	Světlovdný kabel HP 3,5*1800 mm HTT* žlutý	HTT fiber optic cable BlueLine 3.5*1800 mm yellow	364
00-22330-40CE	Světlovdný kabel HP 3,5*2300 mm HTT* červený	HTT fiber optic cable BlueLine 3.5*2300 mm red	364
00-22330-40MO	Světlovdný kabel HP 3,5*2300 mm HTT* modrý	HTT fiber optic cable BlueLine 3.5*2300 mm blue	364
00-22330-40OR	Světlovdný kabel HP 3,5*2300 mm HTT* oranžový	HTT fiber optic cable BlueLine 3.5*2300 mm orange	364
00-22330-40SE	Světlovdný kabel HP 3,5*2300 mm HTT* šedivý	HTT fiber optic cable BlueLine 3.5*2300 mm grey	364
00-22330-40ZE	Světlovdný kabel HP 3,5*2300 mm HTT* zelený	HTT fiber optic cable BlueLine 3.5*2300 mm green	364
00-22330-40ZL	Světlovdný kabel HP 3,5*2300 mm HTT* žlutý	HTT fiber optic cable BlueLine 3.5*2300 mm yellow	364
00-22330-45CE	Světlovdný kabel HP 3,5*2500 mm HTT* červený	HTT fiber optic cable BlueLine 3.5*2500 mm red	364
00-22330-45MO	Světlovdný kabel HP 3,5*2500 mm HTT* modrý	HTT fiber optic cable BlueLine 3.5*2500 mm blue	364
00-22330-45OR	Světlovdný kabel HP 3,5*2500 mm HTT* oranžový	HTT fiber optic cable BlueLine 3.5*2500 mm orange	364
00-22330-45SE	Světlovdný kabel HP 3,5*2500 mm HTT* šedivý	HTT fiber optic cable BlueLine 3.5*2500 mm grey	364
00-22330-45ZE	Světlovdný kabel HP 3,5*2500 mm HTT* zelený	HTT fiber optic cable BlueLine 3.5*2500 mm green	364
00-22330-45ZL	Světlovdný kabel HP 3,5*2500 mm HTT* žlutý	HTT fiber optic cable BlueLine 3.5*2500 mm yellow	364
00-22330-50CE	Světlovdný kabel HP 3,5*3000 mm HTT* červený	HTT fiber optic cable BlueLine 3.5*3000 mm red	364
00-22330-50MO	Světlovdný kabel HP 3,5*3000 mm HTT* modrý	HTT fiber optic cable BlueLine 3.5*3000 mm blue	364
00-22330-50OR	Světlovdný kabel HP 3,5*3000 mm HTT* oranžový	HTT fiber optic cable BlueLine 3.5*3000 mm orange	364
00-22330-50RU	Světlovdný kabel HP 3,5*3000 mm HTT* růžový	HTT fiber optic cable BlueLine 3.5*3000 mm lilac	364
00-22330-50SE	Světlovdný kabel HP 3,5*3000 mm HTT* šedivý	HTT fiber optic cable BlueLine 3.5*3000 mm grey	364
00-22330-50ZE	Světlovdný kabel HP 3,5*3000 mm HTT* zelený	HTT fiber optic cable BlueLine 3.5*3000 mm green	364
00-22330-50ZL	Světlovdný kabel HP 3,5*3000 mm HTT* žlutý	HTT fiber optic cable BlueLine 3.5*3000 mm yellow	364
00-22330-60CE	Světlovdný kabel HP 3,5*4000 mm HTT* červený	HTT fiber optic cable BlueLine 3.5*4000 mm red	364
00-22330-60MO	Světlovdný kabel HP 3,5*4000 mm HTT* modrý	HTT fiber optic cable BlueLine 3.5*4000 mm blue	364
00-22330-60OR	Světlovdný kabel HP 3,5*4000 mm HTT* oranžový	HTT fiber optic cable BlueLine 3.5*4000 mm orange	364
00-22330-60SE	Světlovdný kabel HP 3,5*4000 mm HTT* šedivý	HTT fiber optic cable BlueLine 3.5*4000 mm grey	364
00-22330-60ZE	Světlovdný kabel HP 3,5*4000 mm HTT* zelený	HTT fiber optic cable BlueLine 3.5*4000 mm green	364
00-22330-60ZL	Světlovdný kabel HP 3,5*4000 mm HTT* žlutý	HTT fiber optic cable BlueLine 3.5*4000 mm yellow	364
00-22330-70CE	Světlovdný kabel HP 3,5*5000 mm HTT* červený	HTT fiber optic cable BlueLine 3.5*5000 mm red	364
00-22330-70MO	Světlovdný kabel HP 3,5*5000 mm HTT* modrý	HTT fiber optic cable BlueLine 3.5*5000 mm blue	364
00-22330-70OR	Světlovdný kabel HP 3,5*5000 mm HTT* oranžový	HTT fiber optic cable BlueLine 3.5*5000 mm orange	364
00-22330-70SE	Světlovdný kabel HP 3,5*5000 mm HTT* šedivý	HTT fiber optic cable BlueLine 3.5*5000 mm grey	364
00-22330-70ZE	Světlovdný kabel HP 3,5*5000 mm HTT* zelený	HTT fiber optic cable BlueLine 3.5*5000 mm green	364
00-22330-70ZL	Světlovdný kabel HP 3,5*5000 mm HTT* žlutý	HTT fiber optic cable BlueLine 3.5*5000 mm yellow	364
02-799-270	Segond nůž na myomy; 27,0 cm	Segond myom knife; 27.0 cm	442
02-990-080	Virchow nůž na chrupavku s dřevěným držadlem; 8,0 cm; 21,0 cm	Virchow cartilage knife with wooden handle; 8.0 cm; 21.0 cm	26
08-875-110	Pinzeta na columellu; 11,0 cm	Columella forceps; 11.0 cm	433
111 91 0068	Zrcadlo čelní s krytem; 9,0 cm	Head mirror with cover; 9.0 cm	364
111 91 0069	Zrcadlo čelní s krytem; 10,0 cm	Head mirror with cover; 10.0 cm	364
111 91 0072	Buck kladívko; 18,0 cm	Buck percussion hammer; 18.0 cm	13
111 91 0073	Babinsky kladívko; 4,0 cm; 22,0 cm	Babinsky percussion hammer; 4.0 cm; 22.0 cm	13
111 91 0074	Rabiner kladívko; 23,0 cm	Rabiner percussion hammer; 23.0 cm	13
111 91 0075	Taylor kladívko reflexní; 18,0 cm	Taylor neurolog. reflex hammer; 18.0 cm	13
111 91 0076	Taylor kladívko reflexní; 20,0 cm	Taylor neurolog. reflex hammer; 20.0 cm	13
111 91 0077	Troemner kladívko; 24,0 cm	Troemner percussion hammer; 24.0 cm	14
111 91 0078	Déjerine kladívko; 20,0 cm	Dejérine percussion hammer; 20.0 cm	14
111 91 0079	Déjerine kladívko s jehlou; 20,0 cm	Dejérine percussion hammer with needle; 20.0 cm	14
111 91 0080	Berliner kladívko reflexní; 20,0 cm	Berliner neurolog. reflex hammer; 20.0 cm	14
111 91 0081	Měřítko; 15,0 cm	Measuring instrument; 15.0 cm	16
111 91 0082	Měřítko; 20,0 cm	Measuring instrument; 20.0 cm	16
111 91 0083	Měřítko; 30,0 cm	Measuring instrument; 30.0 cm	16
111 91 0084	Měřítko; 50,0 cm	Measuring instrument; 50.0 cm	16
111 91 0085	Měřítko; 150,0 cm	Measuring instrument; 150.0 cm	16
111 91 0086	Měřítko x-ray; 50,0 cm	Measuring instrument x-ray; 50.0 cm	16
111 91 0088	Moeltgen goniometr	Moeltgen goniometer	16
111 91 0090	Collin dynamometr pro dospělé; stupnice v kg	Collin dynamometer for adults	16
111 91 0091	Collin dynamometr pro děti; stupnice v kg	Collin dynamometer for children	16
111 91 0093	Martin pelvimetr; 34,0 cm	Martin pelvimeter; 34.0 cm	441
111 91 0111	Hartmann ladička; c 128; 17,0 cm	Hartmann tuning fork; c 128; 17.0 cm	362

číslo – number	název	item	strana – page
111 91 0112	Hartmann ladička; c1 256; 17,0 cm	Hartmann tuning fork; c1 256; 17.0 cm	362
111 91 0113	Hartmann ladička; c2 512; 17,0 cm	Hartmann tuning fork; c2 512; 17.0 cm	362
111 91 0114	Hartmann ladička; c3 1024; 17,0 cm	Hartmann tuning fork; c3 1024; 17.0 cm	362
111 91 0115	Hartmann ladička; c4 2048; 17,0 cm	Hartmann tuning fork; c4 2048; 17.0 cm	362
111 91 0116	Hartmann ladička; c5 4096; 17,0 cm	Hartmann tuning fork; c5 4096; 17.0 cm	362
111 91 0117	Lucae ladička; c 128; 16,5 cm	Lucae tuning fork; c 128; 16.5 cm	362
111 91 0118	Lucae ladička; c1 256; 16,5 cm	Lucae tuning fork; c1 256; 16.5 cm	362
111 91 0119	Lucae ladička; c2 512; 16,5 cm	Lucae tuning fork; c2 512; 16.5 cm	362
111 91 0120	Lucae ladička; c3 1024; 16,5 cm	Lucae tuning fork; c3 1024; 16.5 cm	362
111 91 0121	Lucae ladička; c4 2048; 16,5 cm	Lucae tuning fork; c4 2048; 16.5 cm	362
111 91 0122	Lucae ladička; c5 4096; 16,5 cm	Lucae tuning fork; c5 4096; 16.5 cm	362
111 91 0123	Hartmann-French ladička; c2 16; 16,0 cm	Hartmann-French tuning fork; c2 16; 16.0 cm	362
111 91 0124	Hartmann-French ladička; c2 32; 16,0 cm	Hartmann-French tuning fork; c2 32; 16.0 cm	362
111 91 0125	Hartmann-French ladička; c 64; 16,0 cm	Hartmann-French tuning fork; c 64; 16.0 cm	362
111 91 0126	Hartmann-French ladička; c 128; 16,0 cm	Hartmann-French tuning fork; c 128; 16.0 cm	362
111 91 0127	Hartmann-French ladička; c1 256; 16,0 cm	Hartmann-French tuning fork; c1 256; 16.0 cm	362
111 91 0128	Sada 5 Hartmann ladiček	Set of Hartmann tuning forks	362
111 91 0129	Sada 6 Hartmann ladiček	Set of Hartmann tuning forks	362
111 91 0130	Sada 8 Hartmann ladiček	Set of Hartmann tuning forks	362
111 91 0131	Ladička hliníková; c 64	Tuning fork aluminium; c 64	363
111 91 0132	Ladička hliníková; c 128	Tuning fork aluminium; c 128	363
111 91 0133	Ladička hliníková; c 256	Tuning fork aluminium; c 256	363
111 91 0134	Ladička hliníková; c 512	Tuning fork aluminium; c 512	363
111 91 0135	Ladička hliníková; c 1024	Tuning fork aluminium; c 1024	363
111 91 0136	Ladička hliníková; c 2048	Tuning fork aluminium; c 2048	363
111 91 0138	Sada 5 ladiček hliníkových	Set of 5 tuning forks aluminium	363
111 91 0139	Politzer balonek profukovací komplet	Politzer air bag complete	361
111 91 0140	Politzer balonek profukovací	Politzer air bag	361
111 91 0141	Politzer špička; 15 mm	Politzer point; 15 mm	361
111 91 0142	Politzer špička; 17 mm	Politzer point; 17 mm	361
111 91 0143	Politzer špička; 22 mm	Politzer point; 22 mm	361
111 91 0144	Politzer přechodka	Politzer connecting nozzle	361
111 91 0145	Kabierske zaprašovač komplet	Kabierske powder blower complete	361
111 91 0146	Kabierske balonek ventilový	Kabierske valve rubber bulb	361
111 91 0147	Kabierske sklenice náhradní; 30 ccm	Kabierske spare bottle; 30 ccm	361
111 91 0148	Kabierske zaprašovač - střední díl	Kabierske powder blower – middle part	361
111 91 0149	Kabierske kanyla rovná; 8,0 cm	Kabierske cannula straight; 8.0 cm	361
111 91 0150	Kabierske kanyla rovná; 11,0 cm	Kabierske cannula straight; 11.0 cm	361
111 91 0151	Kabierske kanyla zahnutá; 13,0 cm	Kabierske cannula curved; 13.0 cm	361
112 01 0210	Virchow nůž pitevní na mozek dvojčbřítý; 29 cm	Virchow brain knife; 29.0 cm	26
112 01 0240	Nůž pitevní; 24,0 cm	Post mortem knife; 24.0 cm	26
112 01 0250	Nůž pitevní hrotnatý; 25,5 cm	Post mortem knife; 25.5 cm	26
112 02 0100	Jehla preparační fig.1; 13,5 cm	Dissecting needle fig.1; 13.5 cm	27
112 02 0110	Jehla preparační fig.2; 13,5 cm	Dissecting needle fig.2; 13.5 cm	27
112 02 0300	Jehla preparační; 13,5 cm	Dissecting needle; 13.5 cm	27
112 02 0410	Klička na výtěry; 7,0 cm	Wire loop for microscopy; 7.0 cm	27
112 05 0010	Reiner nůž na sádrové obvazy; 18,5 cm	Reiner plaster knife; 18.5 cm	25
112 08 0060	Skalpel s plochým držadlem bříškatý; 2,0 cm; 15,0 cm	Operating knife fig.1; 2.0 cm; 15.0 cm	21
112 08 0070	Skalpel s plochým držadlem bříškatý; 3,0 cm; 15,0 cm	Operating knife fig.5; 3.0 cm; 15.0 cm	21
112 08 0080	Skalpel s plochým držadlem bříškatý; 4,0 cm; 16,0 cm	Operating knife fig.7; 4.0 cm; 16.0 cm	21
112 08 0090	Skalpel s plochým držadlem bříškatý; 5,0 cm; 16,0 cm	Operating knife fig.9; 5.0 cm; 16.0 cm	21
112 08 0160	Skalpel s plochým držadlem hrotnatý; 2,0 cm; 15,0 cm	Operating knife fig.10; 2.0 cm; 15.0 cm	21
112 08 0170	Skalpel s plochým držadlem hrotnatý; 3,0 cm; 15,0 cm	Operating knife fig.14; 3.0 cm; 15.0 cm	21
112 08 0180	Skalpel s plochým držadlem hrotnatý; 4,0 cm; 16,0 cm	Operating knife fig.16; 4.0 cm; 16.0 cm	21
112 08 0190	Skalpel s plochým držadlem hrotnatý; 5,0 cm; 16,0 cm	Operating knife fig.18; 5.0 cm; 16.0 cm	21
112 08 0260	Skalpel s dlouhým krčkem dvojčbřítý; 17,0 cm	Operating knife; 17.0 cm	22
112 08 0270	Skalpel s dlouhým krčkem bříškatý; 17,5 cm	Operating knife; 17.5 cm	22
112 08 0280	Skalpel s dlouhým krčkem hrotnatý rovný; 17,5 cm	Operating knife; 17.5 cm	22
112 08 0290	Skalpel s dlouhým krčkem hrotnatý zahnutý; 17,5 cm	Operating knife; 17.5 cm	22
112 08 0350	Skalpel s hranatým držadlem hrotnatý; 4,0 cm; 16,0 cm	Operating knife; 4.0 cm; 16.0 cm	22
112 08 0710	Nůž resekcí bříškatý; 17,0 cm	Resection knife; 17.0 cm	22
112 08 0730	Langenbeck nůž amputační bříškatý; 12,0 cm; 24,0 cm	Langenbeck amputating knife; blade 12.0 cm; 24.0 cm	25
112 08 0740	Collin nůž amputační hrotnatý; čepel 16,0 cm; 29,0 cm	Collin amputating knife; blade 16.0 cm; 29.0 cm	25
112 08 0770	Collin nůž amputační hrotnatý; čepel 22,0 cm; 35,0 cm	Collin amputating knife; blade 22.0 cm; 35.0 cm	25
112 08 2080	Jehla epilační kuželová 0,10 mm; 3,1 cm	Depilation needle - conical; 0.10 mm; 3.1 cm	20
112 08 2090	Jehla epilační kuželová 0,09 mm; 3,1 cm	Depilation needle - conical; 0.09 mm; 3.1 cm	20
112 08 2100	Jehla epilační kuželová 0,12 mm; 3,1 cm	Depilation needle - conical; 0.12 mm; 3.1 cm	20
112 09 0010	Nůž na meniskus fig. 1; 17,0 cm	Meniscus knife fig.1; 17.0 cm	27
112 09 0020	Nůž na meniskus fig. 2; 17,0 cm	Meniscus knife fig.2; 17.0 cm	27
112 09 0030	Nůž na meniskus fig. 3; 17,0 cm	Meniscus knife fig.3; 17.0 cm	27
112 12 0120	Humby nůž transplantační; 31,0 cm	Humby transplantation knife; 31.0 cm	28
112 12 0130	Čepel pro nůž transplantační; 15,5 cm	Blade for transplantation knife; 15.5 cm	28
112 14 0400	Nůž na varixy; 22,0 cm	Knife for varices; 22.0 cm	24
112 14 0420	Nůž na varixy fig.3; 28,5 cm	Knife for varices fig.3; 28.5 cm	24
112 14 0510	Nůž na varixy 3,5 mm; 2,1 mm; 22,0 cm	Knife for varices 3.5 mm; 2.1 mm; 22.0 cm	24
112 14 0520	Nůž na varixy 4,0 mm; 2,8 mm; 22,0 cm	Knife for varices 4.0 mm; 2.8 mm; 22.0 cm	24
112 14 0550	Nůž na varixy 2,5 mm; 1,5 mm; 22,0 cm	Knife for varices 2.5 mm; 1.5 mm; 22.0 cm	24
112 14 0570	Nůž na varixy; 3,3 mm; 3,0 mm; 22,0 cm	Knife for varices; 3.3 mm; 3.0 mm; 22.0 cm	24
112 27 0040	Skalpel s hranatým dlouhým držadlem; 22,0 cm	Operating knife for gynaecology; 22.0 cm	442
112 27 0050	Skalpel s hranatým dlouhým držadlem bříškatý; 21,0 cm	Operating knife for gynaecology; 21.0 cm	442
112 27 0060	Skalpel s hranatým dlouhým držadlem hrotnatý; 21,5 cm	Operating knife for gynaecology; 21.5 cm	442
112 29 0010	Agnew jehla paracentézní; 16,5 cm	Agnew paracentesis needle; 16.5 cm	365
112 29 0020	Schwartz jehla paracentézní; 16,5 cm	Schwartz paracentesis needle; 16.5 cm	365
112 29 0040	Lucae jehla paracentézní; 18,0 cm	Lucae paracentesis needle; 18.0 cm	365

číslo – number	název	item	strana – page
112 29 0110	Politzer nůž na furunkl; 17,0 cm	Politzer furuncle knife; 17.0 cm	369
112 30 0260	Ballenger nůž na nosní přepážku fig.1; 20,0 cm	Ballenger knife for septum fig.1; 20.0 cm	369; 433
112 30 0300	Beckmann kyreta nosohltnová fig.1; 22,0 cm	Beckmann adenoid curette fig.1; 22.0 cm	415; 432
112 30 0310	Beckmann kyreta nosohltnová fig.2; 22,0 cm	Beckmann adenoid curette fig.2; 22.0 cm	415; 432
112 30 0320	Beckmann kyreta nosohltnová fig.3; 22,0 cm	Beckmann adenoid curette fig.3; 22.0 cm	415; 432
112 30 0330	Beckmann kyreta nosohltnová fig.4; 22,0 cm	Beckmann adenoid curette fig.4; 22.0 cm	415; 432
112 32 0080	Nůž na flegmonu; 18,0 cm	Phlegmon knife; 18.0 cm	370
112 33 0020	Baginsky nůž hrtanový; 24,5 cm	Baginsky laryngeal knife; 24.5 cm	370
112 38 0010	Dieffenbach skalpel oční bříškatý; 1,7 cm	Dieffenbach operating knife fig.1; 1.7 cm	23
112 38 0020	Dieffenbach skalpel oční bříškatý; 2,0 cm	Dieffenbach operating knife fig.2; 2.0 cm	23
112 38 0030	Dieffenbach skalpel oční bříškatý; 2,5 cm	Dieffenbach operating knife fig.4; 2.5 cm	23
112 38 0040	Dieffenbach skalpel oční bříškatý; 3,0 cm	Dieffenbach operating knife fig.5; 3.0 cm	23
112 38 0110	Dieffenbach skalpel oční hrotnatý; 1,7 cm	Dieffenbach operating knife fig.7; 1.7 cm	23
112 38 0120	Dieffenbach skalpel oční hrotnatý; 2,0 cm	Dieffenbach operating knife fig.8; 2.0 cm	23
112 38 0130	Dieffenbach skalpel oční hrotnatý; 2,5 cm	Dieffenbach operating knife fig.9; 2.5 cm	23
112 38 0140	Dieffenbach skalpel oční hrotnatý; 3,0 cm	Dieffenbach operating knife fig.10; 3.0 cm	23
112 38 2200	Nástroj na cizí tělesa v rohovce dvojité	Double foreign body instrument	23
112 91 0002	Držátko skalpelových čepelek č.3 s měřítkem	Scalpel handle no.3 with ruler	19
112 91 0003	Držátko skalpelových čepelek č.3	Scalpel handle no.3	19; 433; 435
112 91 0004	Držátko skalpelových čepelek č.4	Scalpel handle no.4	19; 435
112 91 0005	Držátko skalpelových čepelek č.3l	Scalpel handle no.3L	19; 434
112 91 0006	Držátko skalpelových čepelek č.4l	Scalpel handle no.4L	19
112 91 0007	Držátko skalpelových čepelek č.7	Scalpel handle no.7	19
112 91 0008	Collin držátko skalpelových čepelek č.8	Collin scalpel handle no.8	19
112 91 0010	Čepelka skalpelová fig.10 (baleno po 100 ks)	Scalpel blades fig. 10 (pck=100 pcs)	20
112 91 0011	Čepelka skalpelová fig.11 (baleno po 100 ks)	Scalpel blades fig. 11 (pck=100 pcs)	20
112 91 0012	Čepelka skalpelová fig.12 (baleno po 100 ks)	Scalpel blades fig. 12 (pck=100 pcs)	20
112 91 0013	Čepelka skalpelová fig.13 (baleno po 100 ks)	Scalpel blades fig. 13 (pck=100 pcs)	20
112 91 0015	Čepelka skalpelová fig.15 (baleno po 100 ks)	Scalpel blades fig. 15 (pck=100 pcs)	20
112 91 0018	Čepelka skalpelová fig.18 (baleno po 100 ks)	Scalpel blades fig. 18 (pck=100 pcs)	20
112 91 0020	Čepelka skalpelová fig.20 (baleno po 100 ks)	Scalpel blades fig. 20 (pck=100 pcs)	20
112 91 0021	Čepelka skalpelová fig.21 (baleno po 100 ks)	Scalpel blades fig. 21 (pck=100 pcs)	20
112 91 0022	Čepelka skalpelová fig.22 (baleno po 100 ks)	Scalpel blades fig. 22 (pck=100 pcs)	20
112 91 0023	Čepelka skalpelová fig.23 (baleno po 100 ks)	Scalpel blades fig. 23 (pck=100 pcs)	20
112 91 0024	Čepelka skalpelová fig.24 (baleno po 100 ks)	Scalpel blades fig. 24 (pck=100 pcs)	20
112 91 0025	Čepelka skalpelová fig.12d (baleno po 100 ks)	Scalpel blades fig. 12d (pck=100 pcs)	20
112 91 0026	Čepelka skalpelová fig.15c (baleno po 100 ks)	Scalpel blades fig. 15c (pck=100 pcs)	20
112 91 0027	Čepelka skalpelová fig.25 (baleno po 100 ks)	Scalpel blades fig. 25 (pck=100 pcs)	20
112 91 0062	Collin nůž amputační; čepel 13,0 cm; 26,0 cm	Collin amputating knife; blade 13.0 cm; 26.0 cm	25
112 91 0067	Catlin nůž amputační; čepel 16,0 cm; 29,0 cm	Catlin amputating knife; blade 16.0 cm; 29.0 cm	25
112 91 0069	Catlin nůž amputační; čepel 22,0 cm; 35,0 cm	Catlin amputating knife; blade 22.0 cm; 35.0 cm	25
112 91 0087	Rehn nůž transplantační; 25,0 cm	Rehn transplantation knife; 25.0 cm	28
112 91 0088	Schink nůž transplantační; 30,0 cm	Schink transplantation knife; 30.0 cm	28
112 91 0089	Čepel k transplantačnímu noži Schink	Blade for transplantation knife Schink	28
112 91 0095	St.Clair-Thompson kyreta na mandle fig.1; 21,0 cm	St.Clair-Thompson adenoid curette fig.1; 21.0 cm	416
112 91 0096	St.Clair-Thompson kyreta na mandle fig.2; 21,0 cm	St.Clair-Thompson adenoid curette fig.2; 21.0 cm	416
112 91 0097	St.Clair-Thompson kyreta na mandle fig.3; 21,0 cm	St.Clair-Thompson adenoid curette fig.3; 21.0 cm	416
112 91 0098	St.Clair-Thompson kyreta na mandle fig.4; 21,0 cm	St.Clair-Thompson adenoid curette fig.4; 21.0 cm	416
112 91 0120	Politzer jehla paracentézní; 16,5 cm	Politzer paracentesis needle; 16.5 cm	365
112 91 0121	Politzer jehla paracentézní; 17,0 cm	Politzer paracentesis needle; 17.0 cm	365
112 91 0129	Barbara jehla; 0,3 mm; 25°; 16,0 cm	Barbara needle; 0.3 mm; 25°	366
112 91 0130	Barbara jehla; 0,6 mm; 25°; 16,0 cm	Barbara needle; 0.6 mm; 25°	366
112 91 0131	Barbara jehla; 1,0 mm; 25°; 16,0 cm	Barbara needle; 1.0 mm; 25°	366
112 91 0132	Shambaugh jehla; 0,3 mm; 45°; 16,0 cm	Shambaugh needle; 0.3 mm; 45°; 16.0 cm	366
112 91 0133	Shambaugh jehla; 0,6 mm; 45°; 16,0 cm	Shambaugh needle; 0.6 mm; 45°; 16.0 cm	366
112 91 0134	Shambaugh jehla; 1,0 mm; 45°; 16,0 cm	Shambaugh needle; 1.0 mm; 45°; 16.0 cm	366
112 91 0135	Shambaugh jehla; 1,2 mm; 45°; 16,0 cm	Shambaugh needle; 1.2 mm; 45°; 16.0 cm	366
112 91 0136	Shambaugh jehla; 1,5 mm; 45°; 16,0 cm	Shambaugh needle; 1.5 mm; 45°; 16.0 cm	366
112 91 0137	Shambaugh jehla; 2,0 mm; 45°; 16,0 cm	Shambaugh needle; 2.0 mm; 45°; 16.0 cm	366
112 91 0138	Shambaugh jehla; 2,5 mm; 45°; 16,0 cm	Shambaugh needle; 2.5 mm; 45°; 16.0 cm	366
112 91 0139	Shambaugh jehla; 0,3 mm; 90°; 16,0 cm	Shambaugh needle; 0.3 mm; 90°; 16.0 cm	366
112 91 0140	Shambaugh jehla; 0,6 mm; 90°; 16,0 cm	Shambaugh needle; 0.6 mm; 90°; 16.0 cm	366
112 91 0141	Shambaugh jehla; 1,0 mm; 90°; 16,0 cm	Shambaugh needle; 1.0 mm; 90°; 16.0 cm	366
112 91 0142	Shambaugh jehla; 1,2 mm; 90°; 16,0 cm	Shambaugh needle; 1.2 mm; 90°; 16.0 cm	366
112 91 0143	Shambaugh jehla; 1,5 mm; 90°; 16,0 cm	Shambaugh needle; 1.5 mm; 90°; 16.0 cm	366
112 91 0144	Shambaugh jehla; 2,0 mm; 90°; 16,0 cm	Shambaugh needle; 2.0 mm; 90°; 16.0 cm	366
112 91 0145	Shambaugh jehla; 2,5 mm; 90°; 16,0 cm	Shambaugh needle; 2.5 mm; 90°; 16.0 cm	366
112 91 0146	Barbara háček; 0,6 mm; 16,0 cm	Barbara hooklet; 0.6 mm; 16.0 cm	366
112 91 0147	Barbara háček; 1,0 mm; 16,0 cm	Barbara hooklet; 1.0 mm; 16.0 cm	366
112 91 0148	Barbara jehla rovná; 16,0 cm	Barbara needle straight; 16.0 cm	366
112 91 0149	Barbara jehla lomená; 16,0 cm	Barbara needle angular; 16.0 cm	366
112 91 0150	Barbara jehla zahnutá; 16,0 cm	Barbara needle curved; 16.0 cm	366
112 91 0151	Rosen jehla zahnutá; 16,0 cm	Rosen needle curved; 16.0 cm	366; 433
112 91 0152	Jehla nahoru zahnutá; 25°; 0,3 mm; 16,0 cm	Needle curved upwards; 25°; 0.3 mm; 16.0 cm	367
112 91 0153	Jehla nahoru zahnutá; 25°; 0,6 mm; 16,0 cm	Needle curved upwards; 25°; 0.6 mm; 16.0 cm	367
112 91 0154	Jehla nahoru zahnutá; 25°; 1,0 mm; 16,0 cm	Needle curved upwards; 25°; 1.0 mm; 16.0 cm	367
112 91 0155	Jehla dolu zahnutá; 25°; 0,3 mm; 16,0 cm	Needle curved downwards; 25°; 0.3 mm; 16.0 cm	367
112 91 0156	Jehla dolu zahnutá; 25°; 0,6 mm; 16,0 cm	Needle curved downwards; 25°; 0.6 mm; 16.0 cm	367
112 91 0157	Jehla dolu zahnutá; 25°; 1,0 mm; 16,0 cm	Needle curved downwards; 25°; 1.0 mm; 16.0 cm	367
112 91 0158	Jehla nahoru zahnutá; 45°; 0,3 mm; 16,0 cm	Needle curved upwards; 45°; 0.3 mm; 16.0 cm	367
112 91 0159	Jehla nahoru zahnutá; 45°; 0,6 mm; 16,0 cm	Needle curved upwards; 45°; 0.6 mm; 16.0 cm	367
112 91 0160	Jehla nahoru zahnutá; 45°; 1,0 mm; 16,0 cm	Needle curved upwards; 45°; 1.0 mm; 16.0 cm	367
112 91 0161	Jehla dolu zahnutá; 45°; 0,3 mm; 16,0 cm	Needle curved downwards; 45°; 0.3 mm; 16.0 cm	367
112 91 0162	Jehla dolu zahnutá; 45°; 0,6 mm; 16,0 cm	Needle curved downwards; 45°; 0.6 mm; 16.0 cm	367



číslo – number	název	item	strana – page
112 91 0163	Jehla dolu zahnutá; 45°; 1,0 mm; 16,0 cm	Needle curved downwards; 45°; 1.0 mm; 16.0 cm	367
112 91 0164	Jehla nahoru zahnutá; 90°; 0,3 mm; 16,0 cm	Needle curved upwards; 90°; 0.3 mm; 16.0 cm	367
112 91 0165	Jehla nahoru zahnutá; 90°; 0,6 mm; 16,0 cm	Needle curved upwards; 90°; 0.6 mm; 16.0 cm	367
112 91 0166	Jehla nahoru zahnutá; 90°; 1,0 mm; 16,0 cm	Needle curved upwards; 90°; 1.0 mm; 16.0 cm	367
112 91 0167	Jehla dolu zahnutá; 90°; 0,3 mm; 16,0 cm	Needle curved downwards; 90°; 0.3 mm; 16.0 cm	367
112 91 0168	Jehla dolu zahnutá; 90°; 0,6 mm; 16,0 cm	Needle curved downwards; 90°; 0.6 mm; 16.0 cm	367
112 91 0169	Jehla dolu zahnutá; 90°; 1,0 mm; 16,0 cm	Needle curved downwards; 90°; 1.0 mm; 16.0 cm	367
112 91 0170	McGee háček nahoru zahnutý; 0,5 mm; 16,0 cm	McGee hooklet curved upwards; 0.5 mm; 16.0 cm	367
112 91 0171	McGee háček nahoru zahnutý; 1,0 mm; 16,0 cm	McGee hooklet curved upwards; 1.0 mm; 16.0 cm	367
112 91 0172	McGee háček dolu zahnutý; 0,5 mm; 16,0 cm	McGee hooklet curved downwards; 0.5 mm; 16.0 cm	367
112 91 0173	McGee háček dolu zahnutý; 1,0 mm; 16,0 cm	McGee hooklet curved downwards; 1.0 mm; 16.0 cm	367
112 91 0174	Barbara jehla rovná; 16,0 cm	Barbara needle straight; 16.0 cm	367
112 91 0175	Rosen jehla zahnutá; 16,0 cm	Rosen needle curved; 16.0 cm	367
112 91 0176	Rosen nůž ušní; 1,0 mm; 16,0 cm	Rosen knife; 1.0 mm; 16.0 cm	368
112 91 0177	Rosen nůž ušní; 1,4 mm; 16,0 cm	Rosen knife; 1.4 mm; 16.0 cm	368
112 91 0178	Rosen nůž ušní; 1,6 mm; 16,0 cm	Rosen knife; 1.6 mm; 16.0 cm	368
112 91 0179	Rosen nůž ušní; 2,0 mm; 16,0 cm	Rosen knife; 2.0 mm; 16.0 cm	368
112 91 0180	Rosen nůž ušní; 2,6 mm; 16,0 cm	Rosen knife; 2.6 mm; 16.0 cm	368
112 91 0181	Rosen nůž ušní; 2,8 mm; 16,0 cm	Rosen knife; 2.8 mm; 16.0 cm	368
112 91 0182	Rosen nůž ušní; 3,0 mm; 16,0 cm	Rosen knife; 3.0 mm; 16.0 cm	368
112 91 0183	Plester nůž ušní rovný; 16,0 cm	Plester knife straight; 16.0 cm	368
112 91 0184	Plester nůž ušní zahnutý; 16,0 cm	Plester knife curved; 16.0 cm	368
112 91 0185	Plester nůž ušní; 16,0 cm	Plester knife; 16.0 cm	368
112 91 0186	Tabb nůž ušní; 16,0 cm	Tabb knife; 16.0 cm	368
112 91 0187	Schuknecht nůž ušní; 16,0 cm	Schuknecht knife; 16.0 cm	368
112 91 0188	Schuknecht nůž ušní; 16,0 cm	Schuknecht knife; 16.0 cm	368
112 91 0189	Wullstein nůž ušní; 16,0 cm	Wullstein knife; 16.0 cm	368
112 91 0190	Schuknecht nůž ušní; 16,0 cm	Schuknecht knife; 16.0 cm	368
112 91 0255	Fomon nůž nosní zahnutý; 16,0 cm	Fomon knife curved; 16.0 cm	370
112 91 0256	Masing nůž nosní; 13,0 cm	Masing knife; 13.0 cm	370
112 91 0258	Cottle nůž nosní; 15,0 cm	Cottle knife; 15.0 cm	370
112 91 0259	Converse nůž nosní; 16,0 cm	Converse nasal knife; 16.0 cm	370
112 91 0260	Joseph nůž na nosní plastiku tupý; 15,0 cm	Joseph knife for nose plastic surgery; 15.0 cm	370
112 91 0261	Freer "D" nůž na nosní přepážku; 15,0 cm	Freer "D" septum knife; 15.0 cm	369
112 91 0262	Freer "E" nůž na nosní přepážku; 15,0 cm	Freer "E" septum knife; 15.0 cm	369
112 91 0263	Freer nůž na nosní přepážku; 15,0 cm	Freer septum knife; 15.0 cm	369
112 91 0264	Bruenings nůž nosní; 16,0 cm	Bruenings knife; 16.0 cm	370
112 91 0265	Čepel náhradní k noži nosnímu Bruenings	Spare blade for 112 91 0264	370
112 91 0272	Beckmann kyreta nosohltanová fig. 5; 22,0 cm	Beckmann adenoid curette straight; 22.0 cm	415
112 91 0273	Beckmann kyreta nosohltanová fig. 6; 22,0 cm	Beckmann adenoid curette straight; 22.0 cm	415
112 91 0274	Beckmann kyreta na mandle zahnutá fig.1; 22,0 cm	Beckmann adenoid curette curved fig.1; 22.0 cm	415
112 91 0275	Beckmann kyreta na mandle zahnutá fig.2; 22,0 cm	Beckmann adenoid curette curved fig.2; 22.0 cm	415
112 91 0276	Beckmann kyreta na mandle zahnutá fig.3; 22,0 cm	Beckmann adenoid curette curved fig.3; 22.0 cm	415
112 91 0277	Beckmann kyreta na mandle zahnutá fig.4; 22,0 cm	Beckmann adenoid curette curved fig.4; 22.0 cm	415
112 91 0278	Beckmann kyreta na mandle zahnutá fig.5; 22,0 cm	Beckmann adenoid curette curved fig.5; 22.0 cm	415
112 91 0279	Beckmann kyreta na mandle zahnutá fig.6; 22,0 cm	Beckmann adenoid curette curved fig.6; 22.0 cm	415
112 91 0280	Barnhill kyreta na mandle fig.1; 22,0 cm	Barnhill adenoid curette fig.1; 22.0 cm	416
112 91 0281	Barnhill kyreta na mandle fig.2; 22,0 cm	Barnhill adenoid curette fig.2; 22.0 cm	416
112 91 0282	Barnhill kyreta na mandle fig.3; 22,0 cm	Barnhill adenoid curette fig.3; 22.0 cm	416
112 91 0283	Barnhill kyreta na mandle fig.4; 22,0 cm	Barnhill adenoid curette fig.4; 22.0 cm	416
112 91 0284	La Force adenotom perforovaný fig.1; 25 cm	La Force adenotom perforated fig.1; 25 cm	371
112 91 0285	La Force adenotom perforovaný fig.2; 25 cm	La Force adenotom perforated fig.2; 25 cm	371
112 91 0286	La Force adenotom perforovaný fig.3; 25 cm	La Force adenotom perforated fig.3; 25 cm	371
112 91 0287	La Force čepel adenotomu perforovaná fig.1	La Force spare blades perforated fig.1	371
112 91 0288	La Force čepel adenotomu perforovaná fig.2	La Force spare blades perforated fig.2	371
112 91 0289	La Force čepel adenotomu perforovaná fig.3	La Force spare blades perforated fig.3	371
112 91 0290	La Force adenotom fig. 1; 25,0 cm	La Force adenotom; 25.0 cm	371
112 91 0291	La Force adenotom fig. 2; 25,0 cm	La Force adenotom; 25.0 cm	371
112 91 0292	La Force adenotom fig. 3; 25,0 cm	La Force adenotom; 25.0 cm	371
112 91 0293	Čepel náhradní pro La Force fig.1	Spare blade for La Force	371
112 91 0294	Čepel náhradní pro La Force fig.2	Spare blade for La Force	371
112 91 0295	Čepel náhradní pro La Force fig.3	Spare blade for La Force	371
112 91 0309	Yasargil nástroj mikro; 18,5 cm	Yasargil micro instrument; 18.5 cm	501
112 91 0310	Yasargil nástroj mikro; 18,5 cm	Yasargil micro instrument; 18.5 cm	501
112 91 0311	Yasargil nástroj mikro; 18,5 cm	Yasargil micro instrument; 18.5 cm	501
112 91 0312	Yasargil nástroj mikro; 18,5 cm	Yasargil micro instrument; 18.5 cm	501
112 91 0313	Yasargil nástroj mikro; 18,5 cm	Yasargil micro instrument; 18.5 cm	501
112 91 0314	Yasargil nástroj mikro; 18,5 cm	Yasargil micro instrument; 18.5 cm	501
112 91 0315	Yasargil nástroj mikro; 18,5 cm	Yasargil micro instrument; 18.5 cm	501
112 91 0316	Yasargil nástroj mikro; 18,5 cm	Yasargil micro instrument; 18.5 cm	501
112 91 0317	Yasargil nástroj mikro; 18,5 cm	Yasargil micro instrument; 18.5 cm	501
112 91 0318	Koos nástroj mikro; 19,0 cm	Koos micro instrument; 19.0 cm	502
112 91 0319	Koos nástroj mikro; 19,0 cm	Koos micro instrument; 19.0 cm	502
112 91 0320	Koos nástroj mikro; 19,0 cm	Koos micro instrument; 19.0 cm	502
112 91 0321	Koos nástroj mikro; 19,0 cm	Koos micro instrument; 19.0 cm	502
112 91 0322	Koos nástroj mikro; 19,0 cm	Koos micro instrument; 19.0 cm	502
112 91 0323	Koos nástroj mikro; 19,0 cm	Koos micro instrument; 19.0 cm	502
112 91 0324	Kraus nástroj mikro; 19; 0 cm	Kraus micro instrument; 19.0 cm	502
112 91 0325	Yasargil nástroj mikro; 19,0 cm	Yasargil micro instrument; 19.0 cm	503
112 91 0326	Yasargil nástroj mikro; 19,0 cm	Yasargil micro instrument; 19.0 cm	503
112 91 0327	Jacobson nástroj mikro; 19,0 cm	Jacobson micro instrument; 19.0 cm	503
112 99 0014	Nůž klapův; 4 mm; 22 cm	Klapp knife; 4 mm; 22 cm	24
113 01 0210	Nůžky na kosti pro anatomii rovné; 23,0 cm	Bone scissors straight; 23.0 cm	31
113 05 0020	Richter nůžky chirurgické tupé lomené; 14,5 cm	Richter operating scissors blunt; 14.5 cm	31

číslo – number	název	item	strana – page
113 05 0030	Lister nůžky na obvazy; 16,0 cm	Lister bandage scissors; 16.0 cm	56
113 05 0040	Lister nůžky na obvazy; 20,0 cm	Lister bandage scissors; 20.0 cm	56
113 05 0210	Nůžky na měkké obvazy; 23,0 cm	Plaster scissors; 23.0 cm	55
113 08 0010	Nůžky chirurgické rovné hrotnaté; 13,0 cm	Standard operating scissors straight sharp; 13.0 cm	32
113 08 0020	Nůžky chirurgické rovné hrotnaté; 15,0 cm	Standard operating scissors straight sharp; 15.0 cm	32
113 08 0040	Nůžky chirurgické rovné hrotnaté; 18,5 cm	Standard operating scissors straight sharp; 18.5 cm	32
113 08 0060	Nůžky chirurgické rovné hrotnaté; 22,0 cm	Standard operating scissors straight sharp; 22.0 cm	32
113 08 0070	Nůžky chirurgické rovné hrotnaté; 30,0 cm	Standard operating scissors straight sharp; 30.0 cm	32
113 08 0110	Nůžky chirurgické rovné hrotnatotupé; 13,0 cm	Standard operating scissors straight sharp-blunt; 13.0 cm	32
113 08 0120	Nůžky chirurgické rovné hrotnatotupé; 15,0 cm	Standard operating scissors straight sharp-blunt; 15.0 cm	32
113 08 0140	Nůžky chirurgické rovné hrotnatotupé; 18,5 cm	Standard operating scissors straight sharp-blunt; 18.5 cm	32
113 08 0160	Nůžky chirurgické rovné hrotnatotupé; 22,0 cm	Standard operating scissors straight sharp-blunt; 22.0 cm	32
113 08 0210	Nůžky chirurgické rovné tupé; 13,0 cm	Standard operating scissors straight blunt; 13.0 cm	32
113 08 0220	Nůžky chirurgické rovné tupé; 15,0 cm	Standard operating scissors straight blunt; 15.0 cm	32
113 08 0240	Nůžky chirurgické rovné tupé; 18,5 cm	Standard operating scissors straight blunt; 18.5 cm	32
113 08 0260	Nůžky chirurgické rovné tupé; 22,0 cm	Standard operating scissors straight blunt; 22.0 cm	32
113 08 0310	Nůžky chirurgické zahnuté hrotnaté; 13,0 cm	Standard operating scissors curved sharp; 13.0 cm	32
113 08 0320	Nůžky chirurgické zahnuté hrotnaté; 15,0 cm	Standard operating scissors curved sharp; 15.0 cm	32
113 08 0340	Nůžky chirurgické zahnuté hrotnaté; 18,5 cm	Standard operating scissors curved sharp; 18.5 cm	32
113 08 0360	Nůžky chirurgické zahnuté hrotnaté; 22,0 cm	Standard operating scissors curved sharp; 22.0 cm	32
113 08 0370	Nůžky chirurgické zahnuté hrotnaté; 30,0 cm	Standard operating scissors curved sharp; 30.0 cm	32
113 08 0410	Nůžky chirurgické zahnuté hrotnatotupé; 13,0 cm	Standard operating scissors curved sharp-blunt; 13.0 cm	32
113 08 0420	Nůžky chirurgické zahnuté hrotnatotupé; 15,0 cm	Standard operating scissors curved sharp-blunt; 15.0 cm	32
113 08 0440	Nůžky chirurgické zahnuté hrotnatotupé; 18,5 cm	Standard operating scissors curved sharp-blunt; 18.5 cm	32
113 08 0460	Nůžky chirurgické zahnuté hrotnatotupé; 22,0 cm	Standard operating scissors curved sharp-blunt; 22.0 cm	32
113 08 0510	Nůžky chirurgické zahnuté tupé; 13,0 cm	Standard operating scissors curved blunt; 13.0 cm	32
113 08 0520	Nůžky chirurgické zahnuté tupé; 15,0 cm	Standard operating scissors curved blunt; 15.0 cm	32
113 08 0540	Nůžky chirurgické zahnuté tupé; 18,5 cm	Standard operating scissors curved blunt; 18.5 cm	32
113 08 0560	Nůžky chirurgické zahnuté tupé; 22,0 cm	Standard operating scissors curved blunt; 22.0 cm	32
113 08 0700	Metzenbaum nůžky preparační zahnuté; 14,0 cm	Metzenbaum dissecting scissors curved; 14.0 cm	37
113 08 0810	Nůžky chirurgické na incisi; 15,0 cm	Incision scissors; 15.0 cm	31
113 08 0830	Mayo nůžky preparační rovné extra silné; 17,0 cm	Mayo dissecting scissors straight; 17.0 cm	39
113 08 0840	Mayo nůžky preparační zahnuté extra silné; 17,0 cm	Mayo dissecting scissors curved; 17.0 cm	39
113 08 0880	Nůžky preparační rovné jemné; 18,5 cm	Dissecting scissors straight; 18.5 cm	40
113 08 0890	Nůžky preparační zahnuté jemné; 18,5 cm	Dissecting scissors curved; 18.5 cm	40
113 08 0930	Nůžky preparační rovné; 17,0 cm	Dissecting scissors straight; 17.0 cm	40
113 08 0940	Nůžky preparační zahnuté; 17,0 cm	Dissecting scissors curved; 17.0 cm	40
113 08 1000	Nůžky na střihání vlasů rovné hrotnaté; 16,5 cm	Hair scissors; 16.5 cm	55
113 10 0120	Nůžky preparační dětské tupé zahnuté; 18,5 cm	Dissecting scissors curved blunt; 18.5 cm	41
113 10 0220	Nůžky preparační tupé zahnuté jemné; 18,5 cm	Dissecting scissors curved blunt; 18.5 cm	41
113 12 0010	Nůžky preparační s oboustraným ostřím rovné; 12,0 cm	Dissecting scissors straight; 12.0 cm	42
113 12 0020	Nůžky preparační s oboustraným ostřím zahnuté; 12,0 cm	Dissecting scissors curved; 12.0 cm	42; 433; 435
113 27 0010	Siebolt nůžky děložní; 24,0 cm	Siebolt uterine scissors; 24.0 cm	36; 444
113 30 0010	Heymann nůžky nosní lomené; 18,0 cm	Heymann nasal scissors; 18.0 cm	48; 433
113 32 0010	Prince nůžky na mandle; 18,5 cm	Prince tonsil scissors; 18.5 cm	48; 432; 434
113 38 0010	Nůžky oční rovné hrotnaté; 10,0 cm	Eye scissors straight sharp; 10.0 cm	49
113 38 0020	Nůžky oční rovné hrotnatotupé; 10,0 cm	Eye scissors straight sharp-blunt; 10.0 cm	49
113 38 0030	Nůžky oční rovné tupé; 10,0 cm	Eye scissors straight blunt; 10.0 cm	49
113 38 0040	Nůžky oční zahnuté hrotnaté; 10,0 cm	Eye scissors curved sharp; 10.0 cm	49
113 38 0050	Nůžky oční zahnuté hrotnatotupé; 10,0 cm	Eye scissors curved sharp-blunt; 10.0 cm	49
113 38 0060	Nůžky oční zahnuté tupé; 10,0 cm	Eye scissors curved blunt; 10.0 cm	49
113 38 0071	Nůžky oční rovné hrotnaté; 11,5 cm	Eye scissors straight sharp; 11.5 cm	49
113 38 0081	Nůžky oční rovné tupé; 11,5 cm	Eye scissors straight blunt; 11.5 cm	49
113 38 0091	Nůžky oční zahnuté hrotnaté; 11,5 cm	Eye scissors curved sharp; 11.5 cm	49
113 38 0100	Nůžky oční zahnuté hrotnatotupé; 11,5 cm	Eye scissors curved sharp-blunt; 11.5 cm	49
113 38 0150	Nůžky oční rovné hrotnatotupé; 11,5 cm	Eye scissors straight sharp-blunt; 11.5 cm	49
113 38 0161	Nůžky oční zahnuté tupé; 11,5 cm	Eye scissors curved blunt; 11.5 cm	49
113 38 0210	Nůžky oční lomené hrotnaté; 10,5 cm	Eye scissors angled sharp; 10.5 cm	49
113 38 0260	Nůžky oční lomené tupé; 10,5 cm	Eye scissors angled blunt; 10.5 cm	49
113 38 0311	Nůžky oční stranou zahnuté hrotnaté; 11,5 cm	Eye scissors curved sharp; 11.5 cm	49
113 38 0850	Nůžky oční pružinové rovné rohokové; 12,0 cm	Eye scissors for cornea straight; 12.0 cm	51
113 38 0860	Nůžky oční pružinové zahnuté rohokové; 11,0 cm	Eye scissors for cornea curved; 11.0 cm	51
113 38 1020	Nůžky oční pružinové zahnuté rohokové; 9,0 cm	Eye scissors bent for cornea; 9.0 cm	51
113 38 1030	Nůžky oční pružinové lomené rohokové; 9,0 cm	Eye scissors for cornea; 9.0 cm	51
113 50 0010	Nůžky na dáseň rovné hrotnaté; 12,0 cm	Gum scissors straight sharp; 12.0 cm	57
113 50 0020	Nůžky na dáseň zahnuté hrotnaté; 12,0 cm	Gum scissors curved sharp; 12.0 cm	57
113 50 0030	Nůžky na dáseň rovné hrotnaté; 14,5 cm	Gum scissors straight sharp; 14.5 cm	57
113 50 0040	Nůžky na dáseň zahnuté hrotnaté; 14,5 cm	Gum scissors curved sharp; 14.5 cm	57
113 91 0001	Nůžky chirurgické tupé rovné; 10,5 cm	Standard operating scissors straight blunt; 10.5 cm	33
113 91 0002	Nůžky chirurgické tupé rovné; 11,5 cm	Standard operating scissors straight blunt; 11.5 cm	33
113 91 0003	Nůžky chirurgické tupé rovné; 13,0 cm	Standard operating scissors straight blunt; 13.0 cm	33
113 91 0004	Nůžky chirurgické tupé rovné; 14,5 cm	Standard operating scissors straight blunt; 14.5 cm	33
113 91 0005	Nůžky chirurgické tupé rovné; 15,5 cm	Standard operating scissors straight blunt; 15.5 cm	33
113 91 0006	Nůžky chirurgické tupé rovné; 16,5 cm	Standard operating scissors straight blunt; 16.5 cm	33
113 91 0008	Nůžky chirurgické tupé rovné; 18,5 cm	Standard operating scissors straight blunt; 18.5 cm	33
113 91 0009	Nůžky chirurgické tupé rovné; 20,0 cm	Standard operating scissors straight blunt; 20.0 cm	33
113 91 0011	Nůžky chirurgické tupé zahnuté; 11,5 cm	Standard operating scissors curved blunt; 11.5 cm	33
113 91 0012	Nůžky chirurgické tupé zahnuté; 13,0 cm	Standard operating scissors curved blunt; 13.0 cm	33
113 91 0013	Nůžky chirurgické tupé zahnuté; 14,5 cm	Standard operating scissors curved blunt; 14.5 cm	33
113 91 0014	Nůžky chirurgické tupé zahnuté; 15,0 cm	Standard operating scissors curved blunt; 15.0 cm	33
113 91 0015	Nůžky chirurgické tupé zahnuté; 16,5 cm	Standard operating scissors curved blunt; 16.5 cm	33
113 91 0017	Nůžky chirurgické tupé zahnuté; 18,5 cm	Standard operating scissors curved blunt; 18.5 cm	33
113 91 0018	Nůžky chirurgické tupé zahnuté; 20,0 cm	Standard operating scissors curved blunt; 20.0 cm	33
113 91 0019	Nůžky chirurgické hrotnatotupé rovné; 10,5 cm	Standard operating scissors straight sharp-blunt; 10.5 cm	33

číslo – number	název	item	strana – page
113 91 0020	Nůžky chirurgické hrotnatotupé rovné; 11,5 cm	Standard operating scissors straight sharp-blunt; 11.5 cm	33
113 91 0021	Nůžky chirurgické hrotnatotupé rovné; 13,0 cm	Standard operating scissors straight sharp-blunt; 13.0 cm	33
113 91 0022	Nůžky chirurgické hrotnatotupé rovné SC; 14,5 cm	Standard operating scissors straight sharp-blunt SC; 14.5 cm	59
113 91 0023	Nůžky chirurgické hrotnatotupé rovné; 15,5 cm	Standard operating scissors straight sharp-blunt; 15.5 cm	33
113 91 0024	Nůžky chirurgické hrotnatotupé zahnuté SC; 15,5 cm	Standard operating scissors curved sharp-blunt SC; 14.5 cm	59
113 91 0026	Nůžky chirurgické hrotnatotupé rovné; 16,5 cm	Standard operating scissors straight sharp-blunt; 16.5 cm	33
113 91 0027	Nůžky chirurgické hrotnatotupé rovné; 18,5 cm	Standard operating scissors straight sharp-blunt; 18.5 cm	33
113 91 0029	Nůžky chirurgické hrotnatotupé rovné; 20,0 cm	Standard operating scissors straight sharp-blunt; 20.0 cm	33
113 91 0031	Nůžky chirurgické hrotnatotupé zahnuté; 11,5 cm	Standard operating scissors curved sharp-blunt; 11.5 cm	33
113 91 0032	Nůžky chirurgické hrotnatotupé zahnuté; 13,0 cm	Standard operating scissors curved sharp-blunt; 13.0 cm	33
113 91 0033	Nůžky chirurgické hrotnatotupé zahnuté; 14,5 cm	Standard operating scissors curved sharp-blunt; 14.5 cm	33
113 91 0034	Nůžky chirurgické hrotnatotupé zahnuté; 15,5 cm	Standard operating scissors curved sharp-blunt; 15.5 cm	33
113 91 0037	Nůžky chirurgické hrotnatotupé zahnuté; 16,5 cm	Standard operating scissors curved sharp-blunt; 16.5 cm	33
113 91 0039	Nůžky chirurgické hrotnatotupé zahnuté; 18,5 cm	Standard operating scissors curved sharp-blunt; 18.5 cm	33
113 91 0040	Nůžky chirurgické hrotnatotupé zahnuté; 20,0 cm	Standard operating scissors curved sharp-blunt; 20.0 cm	33
113 91 0041	Nůžky chirurgické hrotnaté rovné; 10,5 cm	Standard operating scissors straight sharp; 10.5 cm	33
113 91 0042	Nůžky chirurgické hrotnaté rovné; 11,5 cm	Standard operating scissors straight sharp; 11.5 cm	33
113 91 0043	Nůžky chirurgické hrotnaté rovné; 13,0 cm	Standard operating scissors straight sharp; 13.0 cm	33
113 91 0044	Nůžky chirurgické hrotnaté rovné; 14,5 cm	Standard operating scissors straight sharp; 14.5 cm	33
113 91 0045	Nůžky chirurgické hrotnaté rovné; 15,5 cm	Standard operating scissors straight sharp; 15.5 cm	33
113 91 0046	Nůžky chirurgické hrotnaté rovné; 16,5 cm	Standard operating scissors straight sharp; 16.5 cm	33
113 91 0047	Nůžky chirurgické hrotnaté rovné; 18,5 cm	Standard operating scissors straight sharp; 18.5 cm	33
113 91 0049	Nůžky chirurgické hrotnaté rovné; 20,0 cm	Standard operating scissors straight sharp; 20.0 cm	33
113 91 0051	Nůžky chirurgické hrotnaté zahnuté; 11,5 cm	Standard operating scissors curved sharp; 11.5 cm	33
113 91 0052	Nůžky chirurgické hrotnaté zahnuté; 13,0 cm	Standard operating scissors curved sharp; 13.0 cm	33
113 91 0053	Nůžky chirurgické hrotnaté zahnuté; 14,5 cm	Standard operating scissors curved sharp; 14.5 cm	33
113 91 0054	Nůžky chirurgické hrotnaté zahnuté; 15,5 cm	Standard operating scissors curved sharp; 15.5 cm	33
113 91 0055	Nůžky chirurgické hrotnaté zahnuté; 16,5 cm	Standard operating scissors curved sharp; 16.5 cm	33
113 91 0057	Nůžky chirurgické hrotnaté zahnuté; 18,5 cm	Standard operating scissors curved sharp; 18.5 cm	33
113 91 0058	Nůžky chirurgické hrotnaté zahnuté; 20,0 cm	Standard operating scissors curved sharp; 20.0 cm	33
113 91 0059	Nůžky chirurgické hrotnatotupé rovné; 14,5 cm	Standard operating scissors straight sharp-blunt; 14.5 cm	33
113 91 0071	Nůžky na incisi; 13,0 cm	Incision scissors; 13.0 cm	31
113 91 0075	Fergusson nůžky chirurgické; 16,5 cm	Fergusson operating scissors; 16.5 cm	34
113 91 0076	Fergusson nůžky chirurgické; 18,0 cm	Fergusson operating scissors; 18.0 cm	34
113 91 0077	Deaver nůžky chirurgické hrotnatotupé rovné; 14,0 cm	Deaver operating scissors straight sharp-blunt; 14.0 cm	34
113 91 0078	Deaver nůžky chirurgické hrotnatotupé zahnuté; 14,0 cm	Deaver operating scissors curved sharp-blunt; 14.0 cm	34
113 91 0083	Mayo nůžky preparační tupé rovné; 14,5 cm	Mayo dissecting scissors straight blunt; 14.5 cm	39
113 91 0084	Mayo nůžky preparační tupé rovné SC; 14,5 cm	Mayo dissecting scissors straight blunt SC; 14.5 cm	59
113 91 0086	Mayo nůžky preparační tupé rovné SC; 17,0 cm	Mayo dissecting scissors straight blunt SC; 17.0 cm	59
113 91 0087	Mayo nůžky preparační tupé rovné; 23,0 cm	Mayo dissecting scissors straight blunt; 23.0 cm	39
113 91 0088	Mayo nůžky preparační tupé rovné SC; 23,0 cm	Mayo dissecting scissors straight blunt SC; 23.0 cm	59
113 91 0090	Mayo nůžky preparační tupé zahnuté; 14,5 cm	Mayo dissecting scissors curved blunt; 14.5 cm	39
113 91 0091	Mayo nůžky preparační tupé zahnuté SC; 14,5 cm	Mayo dissecting scissors curved blunt SC; 14.5 cm	59
113 91 0093	Mayo nůžky preparační tupé zahnuté SC; 17,0 cm	Mayo dissecting scissors curved blunt SC; 17.0 cm	59
113 91 0094	Mayo nůžky preparační tupé zahnuté; 23,0 cm	Mayo dissecting scissors curved blunt; 23.0 cm	39
113 91 0095	Mayo nůžky preparační tupé zahnuté SC; 23,0 cm	Mayo dissecting scissors curved blunt SC; 23.0 cm	59
113 91 0097	Mayo-Stille nůžky preparační tupé rovné; 15,0 cm	Mayo-Stille dissecting scissors straight blunt; 15.0 cm	39
113 91 0098	Mayo-Stille nůžky preparační tupé rovné; 17,0 cm	Mayo-Stille dissecting scissors straight blunt; 17.0 cm	39
113 91 0101	Mayo-Stille nůžky preparační tupé zahnuté; 15,0 cm	Mayo-Stille dissecting scissors curved blunt; 15.0 cm	39; 433; 435
113 91 0102	Mayo-Stille nůžky preparační tupé zahnuté; 17,0 cm	Mayo-Stille dissecting scissors curved blunt; 17.0 cm	39
113 91 0106	Doyen nůžky břišní tupé rovné; 16,0 cm	Doyen abdominal scissors straight; 16.0 cm	35
113 91 0107	Doyen nůžky břišní tupé zahnuté; 16,0 cm	Doyen abdominal scissors curved; 16.0 cm	35
113 91 0110	Kelly nůžky na fistuli rovné; 16,0 cm	Kelly fistula scissors straight; 16.0 cm	35; 443
113 91 0112	Kelly nůžky na fistuli zahnuté; 16,0 cm	Kelly fistula scissors curved; 16.0 cm	35; 443
113 91 0116	Wertheim nůžky břišní tupé zahnuté; 22,5 cm	Wertheim operating scissors curved; 22.5 cm	35
113 91 0117	Sims nůžky gynekologické tupé rovné; 20,0 cm	Sims gynaecological scissors straight blunt; 20.0 cm	36; 444
113 91 0118	Sims nůžky gynekologické tupé rovné; 23,0 cm	Sims gynaecological scissors straight blunt; 23.0 cm	36; 444
113 91 0119	Sims nůžky gynekologické tupé zahnuté; 20,0 cm	Sims gynaecological scissors curved blunt; 20.0 cm	36; 444
113 91 0120	Sims nůžky gynekologické tupé zahnuté; 23,0 cm	Sims gynaecological scissors curved blunt; 23.0 cm	36; 444
113 91 0121	Sims nůžky gynekologické hrotnatotupé rovné; 20,0 cm	Sims gynaecological scissors straight sharp-blunt; 20.0 cm	36; 444
113 91 0122	Sims nůžky gynekologické tupé rovné; 23,0 cm	Sims gynaecological scissors straight sharp; 23.0 cm	36; 444
113 91 0123	Sims nůžky gynekologické hrotnatotupé zahnuté; 20,0 cm	Sims gynaecological scissors curved sharp-blunt; 20.0 cm	36; 444
113 91 0124	Sims nůžky gynekologické hrotnatotupé zahnuté; 23,0 cm	Sims gynaecological scissors curved sharp-blunt; 23.0 cm	36; 444
113 91 0125	Sims nůžky gynekologické hrotnaté rovné; 20,0 cm	Sims gynaecological scissors straight sharp; 20.0 cm	36; 444
113 91 0126	Sims nůžky gynekologické hrotnatotupé rovné; 23,0 cm	Sims gynaecological scissors straight sharp-blunt; 23.0 cm	36; 444
113 91 0127	Sims nůžky gynekologické hrotnaté zahnuté; 20,0 cm	Sims gynaecological scissors curved sharp; 20.0 cm	36; 444
113 91 0128	Sims nůžky gynekologické hrotnaté zahnuté; 23,0 cm	Sims gynaecological scissors curved sharp; 23.0 cm	36; 444
113 91 0129	Dubois nůžky gynekologické tupé rovné; 27,0 cm	Dubois cephalotomy scissors straight blunt; 27.0 cm	36; 444
113 91 0130	Dubois nůžky gynekologické tupé zahnuté; 27,0 cm	Dubois cephalotomy scissors curved blunt; 27.0 cm	36; 444
113 91 0133	Metzenbaum nůžky preparační tupé rovné; 14,5 cm	Metzenbaum dissecting scissors blunt straight; 14.5 cm	37
113 91 0134	Metzenbaum nůžky preparační tupé rovné SC; 14,5 cm	Metzenbaum dissecting scissors blunt straight SC; 14.5 cm	60
113 91 0135	Metzenbaum nůžky preparační tupé zahnuté; 14,5 cm	Metzenbaum dissecting scissors blunt curved; 14.5 cm	37
113 91 0136	Metzenbaum nůžky preparační tupé zahnuté SC; 14,5 cm	Metzenbaum dissecting scissors blunt curved SC; 14.5 cm	60
113 91 0139	Metzenbaum nůžky preparační hrotnaté rovné; 14,5 cm	Metzenbaum dissecting scissors sharp straight; 14.5 cm	37
113 91 0140	Metzenbaum nůžky preparační hrotnaté zahnuté; 14,5 cm	Metzenbaum dissecting scissors sharp curved; 14.5 cm	37
113 91 0143	Metzenbaum-Nelson nůžky preparační tupé rovné; 18,0 cm	Metzenbaum-Nelson dissecting scissors straight; 18.0 cm	37
113 91 0144	Metzenbaum-Nelson nůžky preparační tupé rovné SC; 18,0 cm	Metzenbaum-Nelson dissecting scissors straight SC; 18.0 cm	60
113 91 0145	Metzenbaum-Nelson nůžky preparační tupé rovné; 20,0 cm	Metzenbaum-Nelson dissecting scissors straight; 20.0 cm	37
113 91 0146	Metzenbaum-Nelson nůžky preparační tupé rovné SC; 20,0 cm	Metzenbaum-Nelson dissecting scissors straight SC; 20.0 cm	60
113 91 0147	Metzenbaum-Nelson nůžky preparační tupé rovné; 23,0 cm	Metzenbaum-Nelson dissecting scissors straight; 23.0 cm	37
113 91 0148	Metzenbaum-Nelson nůžky preparační tupé rovné SC; 23,0 cm	Metzenbaum-Nelson dissecting scissors straight SC; 23.0 cm	60
113 91 0149	Metzenbaum-Nelson nůžky preparační tupé rovné; 25,0 cm	Metzenbaum-Nelson dissecting scissors straight; 25.0 cm	37
113 91 0150	Metzenbaum-Nelson nůžky preparační tupé rovné; 28,0 cm	Metzenbaum-Nelson dissecting scissors straight; 28.0 cm	37
113 91 0152	Metzenbaum-Nelson nůžky preparační tupé zahnuté; 18,0 cm	Metzenbaum-Nelson dissecting scissors curved; 18.0 cm	37



číslo – number	název	item	strana – page
113 91 0153	Metzenbaum-Nelson nůžky preparační tupé zahnuté SC; 18,0 cm	Metzenbaum-Nelson dissecting scissors curved SC; 18.0 cm	60
113 91 0154	Metzenbaum-Nelson nůžky preparační tupé zahnuté; 20,0 cm	Metzenbaum-Nelson dissecting scissors curved; 20.0 cm	37
113 91 0156	Metzenbaum-Nelson nůžky preparační tupé zahnuté; 23,0 cm	Metzenbaum-Nelson dissecting scissors curved; 23.0 cm	37
113 91 0157	Metzenbaum-Nelson nůžky preparační tupé zahnuté SC; 23,0 cm	Metzenbaum-Nelson dissecting scissors curved SC; 23.0 cm	60
113 91 0158	Metzenbaum-Nelson nůžky preparační tupé zahnuté; 25,0 cm	Metzenbaum-Nelson dissecting scissors curved; 25.0 cm	37
113 91 0159	Metzenbaum-Nelson nůžky preparační tupé zahnuté; 28,0 cm	Metzenbaum-Nelson dissecting scissors curved; 28.0 cm	37
113 91 0185	Metzenbaum-Delicate nůžky preparační tupé rovné; 14,5 cm	Metzenbaum-Delicate dissecting scissors blunt straight; 14.5 cm	38
113 91 0186	Metzenbaum-Delicate nůžky preparační tupé zahnuté; 14,5 cm	Metzenbaum-Delicate dissecting scissors blunt curved; 14.5 cm	38
113 91 0187	Metzenbaum-Delicate nůžky preparační hrotnaté rovné; 14,5 cm	Metzenbaum-Delicate dissecting scissors sharp straight; 14.5 cm	38
113 91 0188	Metzenbaum-Delicate nůžky preparační hrotnaté zahnuté; 14,5 cm	Metzenbaum-Delicate dissecting scissors sharp curved; 14.5 cm	38
113 91 0189	Metzenbaum-Delicate nůžky preparační tupé rovné; 18,0 cm	Metzenbaum-Delicate scissors straight; 18.0 cm	38
113 91 0190	Metzenbaum-Delicate nůžky preparační tupé rovné; 20,0 cm	Metzenbaum-Delicate scissors straight; 20.0 cm	38
113 91 0191	Metzenbaum-Delicate nůžky preparační tupé rovné; 23,0 cm	Metzenbaum-Delicate scissors straight; 23.0 cm	38
113 91 0192	Metzenbaum-Delicate nůžky preparační tupé rovné; 25,0 cm	Metzenbaum-Delicate scissors straight; 25.0 cm	38
113 91 0195	Metzenbaum-Delicate nůžky preparační tupé zahnuté; 18,0 cm	Metzenbaum-Delicate scissors curved; 18.0 cm	38
113 91 0196	Metzenbaum-Delicate nůžky preparační tupé zahnuté; 20,0 cm	Metzenbaum-Delicate scissors curved; 20.0 cm	38
113 91 0197	Metzenbaum-Delicate nůžky preparační tupé zahnuté; 23,0 cm	Metzenbaum-Delicate scissors curved; 23.0 cm	38
113 91 0198	Metzenbaum-Delicate nůžky preparační tupé zahnuté; 25,0 cm	Metzenbaum-Delicate scissors curved; 25.0 cm	38
113 91 0215	Lexer nůžky preparační rovné; 16,0 cm	Lexer dissecting scissors; 16.0 cm	41
113 91 0216	Lexer nůžky preparační zahnuté; 16,0 cm	Lexer dissecting scissors curved; 16.0 cm	41
113 91 0217	Fomon nůžky preparační zahnuté; 13,5 cm	Fomon dissecting scissors curved; 13.5 cm	40
113 91 0218	Thorek nůžky preparační zahnuté; 19,0 cm	Thorek dissecting scissors curved; 19.0 cm	40
113 91 0219	Lexer-Baby nůžky preparační rovné; 10,0 cm	Lexer-Baby dissecting scissors; 10.0 cm	40
113 91 0220	Lexer-Baby nůžky preparační zahnuté; 10,0 cm	Lexer-Baby dissecting scissors curved; 10.0 cm	40
113 91 0221	Sanvenero nůžky preparační hrotnaté rovné; 14,0 cm	Sanvenero dissecting scissors; 14.0 cm	42
113 91 0222	Sanvenero nůžky preparační hrotnaté zahnuté; 14,0 cm	Sanvenero dissecting scissors curved; 14.0 cm	42
113 91 0229	Kilner nůžky preparační zahnuté; 12,0 cm	Kilner dissecting scissors; 12.0 cm	41
113 91 0230	Kilner nůžky preparační zahnuté; 15,0 cm	Kilner dissecting scissors curved; 15.0 cm	41
113 91 0233	Reynolds nůžky preparační ostré rovné; 15,0 cm	Reynolds dissecting scissors; 15.0 cm	42
113 91 0235	Reynolds nůžky preparační ostré zahnuté; 15,0 cm	Reynolds dissecting scissors curved; 15.0 cm	42
113 91 0237	Potts-Smith nůžky zahnuté; 25°; 19,0 cm	Potts-Smith vascular forceps; 25°; 19.0 cm	43
113 91 0238	Potts-Smith nůžky zahnuté; 45°; 19,0 cm	Potts-Smith vascular forceps; 45°; 19.0 cm	43
113 91 0239	Potts-Smith nůžky zahnuté; 60°; 19,0 cm	Potts-Smith vascular forceps; 60°; 19.0 cm	43
113 91 0240	De Bakey nůžky zahnuté; 25°; 16,0 cm	De Bakey vascular scissors; 25°; 16.0 cm	43
113 91 0242	De Bakey nůžky zahnuté; 25°; 23,0 cm	De Bakey vascular scissors; 25°; 23.0 cm	43
113 91 0244	De Bakey nůžky zahnuté; 45°; 16,0 cm	De Bakey vascular scissors; 45°; 16.0 cm	43
113 91 0246	De Bakey nůžky zahnuté; 45°; 23,0 cm	De Bakey vascular scissors; 45°; 23.0 cm	43
113 91 0248	De Bakey nůžky zahnuté; 60°; 16,0 cm	De Bakey vascular scissors; 60°; 16.0 cm	43
113 91 0250	De Bakey nůžky zahnuté; 60°; 23,0 cm	De Bakey vascular scissors; 60°; 23.0 cm	43
113 91 0252	Hegemann-Diethrich nůžky zahnuté; 25°; 16,0 cm	Hegemann-Diethrich vascular scissors; 25°; 16.0 cm	44
113 91 0253	Hegemann-Diethrich nůžky zahnuté; 45°; 16,0 cm	Hegemann-Diethrich vascular scissors; 45°; 16.0 cm	44
113 91 0254	Hegemann-Diethrich nůžky zahnuté; 60°; 16,0 cm	Hegemann-Diethrich vascular scissors; 60°; 16.0 cm	44
113 91 0255	Hegemann-Diethrich nůžky zahnuté; 90°; 16,0 cm	Hegemann-Diethrich vascular scissors; 90°; 16.0 cm	44
113 91 0256	Hegemann-Diethrich nůžky zahnuté; 125°; 16,0 cm	Hegemann-Diethrich vascular scissors; 125°; 16.0 cm	44
113 91 0257	Hegemann-Diethrich nůžky zahnuté; 25°; 19,0 cm	Hegemann-Diethrich vascular scissors; 25°; 19.0 cm	44
113 91 0258	Hegemann-Diethrich nůžky zahnuté; 45°; 19,0 cm	Hegemann-Diethrich vascular scissors; 45°; 19.0 cm	44
113 91 0259	Hegemann-Diethrich nůžky zahnuté; 60°; 19,0 cm	Hegemann-Diethrich vascular scissors; 60°; 19.0 cm	44
113 91 0260	Hegemann-Diethrich nůžky zahnuté; 90°; 19,0 cm	Hegemann-Diethrich vascular scissors; 90°; 19.0 cm	44
113 91 0261	Hegemann-Diethrich nůžky zahnuté; 125°; 19,0 cm	Hegemann-Diethrich vascular scissors; 125°; 19.0 cm	44
113 91 0267	Strully nůžky neurochirurgické zahnuté; 22,0 cm	Strully neurosurgical scissors curved; 22.0 cm	45
113 91 0270	Favaloro nůžky na cévy; 15,0 cm	Favaloro artery scissors; 15.0 cm	45
113 91 0272	De Bakey nůžky na cévy; 15,5 cm	De Bakey artery scissors; 15.5 cm	45
113 91 0273	Potts-De Martel nůžky na cévy lomené; 21,0 cm	Potts-De Martel artery scissors; 21.0 cm	45
113 91 0275	Schmieden-Taylor nůžky neurochirurgické; 14,5 cm	Schmieden-Taylor dura scissors; 14.5 cm	45
113 91 0276	Schmieden-Taylor nůžky neurochirurgické; 17,0 cm	Schmieden-Taylor dura scissors; 17.0 cm	45
113 91 0278	Toennis nůžky neurochirurgické rovné; 18,0 cm	Toennis dissecting scissors straight; 18.0 cm	45
113 91 0279	Toennis nůžky neurochirurgické tupé zahnuté; 18,0 cm	Toennis dissecting scissors curved; 18.0 cm	45
113 91 0280	Klinkenbergh-Loth nůžky neurochirurgické; 23,0 cm	Klinkenbergh-Loth artery scissors; 23.0 cm	46
113 91 0281	Satinsky nůžky neurochirurgické s-zahnuté; 24,5 cm	Satinsky neurosurgical scissors; 24.5 cm	46
113 91 0290	McIndoe nůžky na chrupavku; 19,0 cm	McIndoe cartilage scissors; 19.0 cm	47
113 91 0292	Crafoord nůžky pro lobektomii tupé zahnuté; 30,0 cm	Crafoord lobectomy scissors curved; 30.0 cm	47
113 91 0295	Nůžky na střeva; 21,0 cm	Enterotomy scissors; 21.0 cm	47
113 91 0296	Nůžky na střeva s olivkou; 22,0 cm	Enterotomy scissors; 22.0 cm	47
113 91 0297	Nůžky anatomické hrotnaté rovné; 11,0 cm	Dissecting scissors straight; 11.0 cm	47
113 91 0300	Nůžky anatomické hrotnaté zahnuté; 11,0 cm	Dissecting scissors curved; 11.0 cm	47
113 91 0303	Prince nůžky na mandle zahnuté; 17,5 cm	Prince tonsil scissors curved; 17.5 cm	48
113 91 0305	Good nůžky na mandle zahnuté; 19,0 cm	Good tonsil scissors curved; 19.0 cm	48
113 91 0311	Fomon nůžky nosní tupé; 13,5 cm	Fomon nasal scissors; 13.5 cm	48
113 91 0312	Halle nůžky nosní zahnuté; 19,0 cm	Halle nasal scissors; 19.0 cm	48
113 91 0313	Cottle nůžky nosní tupé; 16,0 cm	Cottle nasal scissors; 16.0 cm	48
113 91 0317	Braun-Stadler nůžky pro episiotomii; 14,0 cm	Braun-Stadler episiotomy scissors; 14.0 cm	35; 443
113 91 0318	Braun-Stadler nůžky pro episiotomii; 22,0 cm	Braun-Stadler episiotomy scissors; 22.0 cm	35; 443
113 91 0319	Waldmann nůžky pro episiotomii; 18,0 cm	Waldmann episiotomy scissors; 18.0 cm	35; 443
113 91 0328	Wagner nůžky jemné hrotnaté rovné; 12,0 cm	Wagner fine scissors; 12.0 cm	34
113 91 0331	Wagner nůžky jemné hrotnaté zahnuté; 12,0 cm	Wagner fine scissors; 12.0 cm	34
113 91 0348	Walton nůžky jemné hrotnaté zahnuté; 10,0 cm	Walton fine scissors sharp curved; 10.0 cm	34
113 91 0349	Mod. Bonn nůžky extra jemné rovné; 8,0 cm	Mod. Bonn extra delicate scissors straight; 8.0 cm	34
113 91 0350	Mod. Bonn nůžky extra jemné zahnuté; 8,0 cm	Mod. Bonn extra delicate scissors curved; 8.0 cm	34
113 91 0364	Nůžky na duhovku ostré rovné SC; 11,5 cm	Iris scissors sharp straight SC; 11.5 cm	61
113 91 0368	Nůžky na duhovku ostré zahnuté SC; 11,5 cm	Iris scissors sharp curved SC; 11.5 cm	61
113 91 0379	Stevens nůžky oční hrotnaté rovné; 10,5 cm	Stevens tenotomy scissors straight sharp; 10.5 cm	50
113 91 0380	Stevens nůžky oční hrotnaté rovné; 11,5 cm	Stevens tenotomy scissors straight sharp; 11.5 cm	50
113 91 0381	Stevens nůžky oční hrotnaté zahnuté; 10,5 cm	Stevens tenotomy scissors curved sharp; 10.5 cm	50
113 91 0382	Stevens nůžky oční hrotnaté zahnuté; 11,5 cm	Stevens tenotomy scissors curved sharp; 11.5 cm	50

číslo – number	název	item	strana – page
113 91 0383	Stevens nůžky oční tupé rovné; 10,5 cm	Stevens tenotomy scissors straight blunt; 10.5 cm	50
113 91 0384	Stevens nůžky oční tupé rovné; 11,5 cm	Stevens tenotomy scissors straight blunt; 11.5 cm	50
113 91 0385	Stevens nůžky oční tupé zahnuté; 10,5 cm	Stevens tenotomy scissors curved blunt; 10.5 cm	50
113 91 0386	Stevens nůžky oční tupé zahnuté; 11,5 cm	Stevens tenotomy scissors curved blunt; 11.5 cm	50
113 91 0387	Nůžky oční hrotnaté rovné; 10,0 cm	Eye scissors straight sharp; 10.0 cm	50
113 91 0388	Nůžky oční hrotnaté zahnuté; 10,0 cm	Eye scissors curved sharp; 10.0 cm	50
113 91 0389	Nůžky oční tupé rovné; 10,0 cm	Eye scissors straight blunt; 10.0 cm	50
113 91 0390	Nůžky oční tupé zahnuté; 10,0 cm	Eye scissors curved blunt; 10.0 cm	50
113 91 0393	Nůžky oční rovné; 9,5 cm	Eye scissors straight; 9.5 cm	50
113 91 0394	Nůžky oční zahnuté; 9,5 cm	Eye scissors curved; 9.5 cm	50
113 91 0395	Nůžky oční rovné; 9,5 cm	Eye scissors straight; 9.5 cm	50
113 91 0396	Nůžky oční zahnuté; 9,5 cm	Eye scissors curved; 9.5 cm	50
113 91 0399	Spencer nůžky pro ligaturu; 9,0 cm	Spencer ligature scissors; 9.0 cm	53
113 91 0400	Spencer nůžky pro ligaturu; 10,5 cm	Spencer ligature scissors; 10.5 cm	53
113 91 0403	Littauer nůžky pro ligaturu; 14,0 cm	Littauer ligature scissors; 14.0 cm	53
113 91 0408	Heath nůžky pro ligaturu; 15,0 cm	Heath ligature scissors; 15.0 cm	53
113 91 0411	Northbent nůžky pro ligaturu zahnuté; 12,5 cm	Northbent ligature scissors curved; 12.5 cm	53
113 91 0432	Universal nůžky na obvazy; 18,0 cm	Universal bandage scissors; 18.0 cm	55
113 91 0437	Smith (mod. USA) nůžky na obvazy; 20,0 cm	Smith (mod. USA) bandage scissors; 20.0 cm	55
113 91 0439	Lorenz nůžky na obvazy zahnuté; 23,0 cm	Lorenz bandage scissors curved; 23.0 cm	55
113 91 0444	Lister-Excentric nůžky na obvazy se zuby; 16,0 cm	Lister-Excentric scissors; 16.0 cm	56
113 91 0445	Lister-Excentric nůžky na obvazy se zuby; 19,0 cm	Lister-Excentric scissors; 19.0 cm	56
113 91 0446	Lister nůžky na obvazy lomené; 9,0 cm	Lister bandage scissors angled; 9.0 cm	56
113 91 0447	Lister nůžky na obvazy lomené; 11,0 cm	Lister bandage scissors angled; 11.0 cm	56
113 91 0448	Lister nůžky na obvazy lomené; 14,0 cm	Lister bandage scissors angled; 14.0 cm	56
113 91 0450	Lister nůžky na obvazy lomené; 18,0 cm	Lister bandage scissors angled; 18.0 cm	56
113 91 0452	Esmarch nůžky na obvazy; 20,0 cm	Esmarch bandage scissors; 20.0 cm	56
113 91 0453	Esmarch nůžky na obvazy; 22,0 cm	Esmarch bandage scissors; 22.0 cm	56
113 91 0454	Seutin nůžky na sádrové obvazy; 23,0 cm	Seutin plaster-of-paris shears; 23.0 cm	56
113 91 0455	Nůžky na sádrové obvazy; 20,0 cm	Plaster-of-paris shears; 20.0 cm	56
113 91 0456	Bruns nůžky na sádrové obvazy se zuby; 24,0 cm	Bruns plaster-of-paris shears; 24.0 cm	56
113 91 0457	Bruns nůžky na sádrové obvazy hladké; 24,0 cm	Bruns plaster-of-paris shears; 24.0 cm	56
113 91 0458	Nůžky na nehty rovné; 9,0 cm	Nail scissors straight; 9.0 cm	58
113 91 0459	Nůžky na nehty rovné; 10,5 cm	Nail scissors straight; 10.5 cm	58
113 91 0460	Nůžky na nehty zahnuté; 9,0 cm	Nail scissors curved; 9.0 cm	58
113 91 0461	Nůžky na nehty zahnuté; 10,5 cm	Nail scissors curved; 10.5 cm	58
113 91 0462	Nůžky na nehty rovné se zahnutými rameny; 9,0 cm	Nail scissors straight; 9.0 cm	58
113 91 0463	Nůžky na nehty rovné se zahnutými rameny; 10,5 cm	Nail scissors straight; 10.5 cm	58
113 91 0464	Nůžky na nehty zahnuté se zahnutými rameny; 9,0 cm	Nail scissors curved; 9.0 cm	58
113 91 0465	Nůžky na nehty zahnuté se zahnutými rameny; 10,5 cm	Nail scissors curved; 10.5 cm	58
113 91 0466	Nůžky na nehtovou kůžičku rovné; 10,0 cm	Cuticle scissors straight; 10.0 cm	58
113 91 0467	Nůžky na nehtovou kůžičku rovné; 11,0 cm	Cuticle scissors straight; 11.0 cm	58
113 91 0468	Nůžky na nehtovou kůžičku zahnuté; 10,0 cm	Cuticle scissors curved; 10.0 cm	58
113 91 0469	Nůžky na nehtovou kůžičku zahnuté; 11,0 cm	Cuticle scissors curved; 11.0 cm	58
113 91 0470	Nůžky na nehty s perem chrom; 10,5 cm	Nail scissors; 10.5 cm	58
113 91 0472	König nůžky na nehty; 13,0 cm	König nail splitting scissors; 13.0 cm	58
113 91 0473	König nůžky na nehty; 15,0 cm	König nail splitting scissors; 15.0 cm	58
113 91 0474	Goldman-Fox nůžky na dáseň rovné; 13,0 cm	Goldman-Fox gum scissors straight; 13.0 cm	57
113 91 0475	Goldman-Fox nůžky na dáseň zahnuté; 13,0 cm	Goldman-Fox gum scissors curved; 13.0 cm	57
113 91 0483	Quinby nůžky na dáseň rovné; 12,0 cm	Quinby gum scissors straight; 12.0 cm	57
113 91 0484	Quinby nůžky na dáseň zahnuté; 12,0 cm	Quinby gum scissors curved; 12.0 cm	57
113 91 0490	Noyes nůžky na duhovku hrotnaté rovné; 12,0 cm	Noyes iris scissors straight sharp; 12.0 cm	51
113 91 0492	Noyes nůžky na duhovku hrotnatotupé rovné; 12,0 cm	Noyes iris scissors straight sharp-blunt; 12.0 cm	51
113 91 0494	Noyes nůžky na duhovku tupé rovné; 12,0 cm	Noyes iris scissors straight blunt; 12.0 cm	51
113 91 0499	Barraquer nůžky na duhovku; 5 mm; 5,5 cm	Barraquer eye scissors; 5.5 cm; 5 mm	51
113 91 0500	Barraquer nůžky na duhovku; 7 mm; 5,5 cm	Barraquer eye scissors; 5.5 cm; 7 mm	51
113 91 0501	Barraquer nůžky na duhovku; 10 mm; 5,5 cm	Barraquer eye scissors; 5.5 cm; 10 mm	51
113 91 0502	Castroviejo nůžky na duhovku ostré rovné; 9,0 cm	Castroviejo iris scissors straight sharp; 9.0 cm	52
113 91 0503	Castroviejo nůžky na duhovku tupé rovné; 9,0 cm	Castroviejo iris scissors straight blunt; 9.0 cm	52
113 91 0504	Castroviejo nůžky na duhovku tupé zahnuté; 9,0 cm	Castroviejo iris scissors curved blunt; 9.0 cm	52
113 91 0505	Castroviejo nůžky na duhovku tupé lomené; 9,0 cm	Castroviejo iris scissors angled blunt; 9.0 cm	52
113 91 0506	Castroviejo nůžky na duhovku ostré lomené; 9,0 cm	Castroviejo iris scissors angled sharp; 9.0 cm	52
113 91 0507	Castroviejo nůžky na duhovku hrotnaté; 10,0 cm	Castroviejo iris scissors sharp; 10.0 cm	52
113 91 0508	Castroviejo nůžky na duhovku tupé; 10,0 cm	Castroviejo iris scissors blunt; 10.0 cm	52
113 91 0517	Westcott nůžky na rohovku hrotnaté; 11,0 cm	Westcott tenotomy scissors sharp; 11.0 cm	52
113 91 0518	Westcott nůžky na rohovku tupé; 11,0 cm	Westcott tenotomy scissors blunt; 11.0 cm	52
113 91 0521	Castroviejo nůžky oční jemné levé; 11,0 cm	Castroviejo delicate eye scissors; 11.0 cm	52
113 91 0522	Castroviejo nůžky oční jemné pravé; 11,0 cm	Castroviejo delicate eye scissors; 11.0 cm	52
113 91 0537	Gomel nůžky mikro zahnuté; 14,5 cm	Gomel dissection micro scissors; 14.5 cm	54
113 91 0538	Gomel nůžky mikro zahnuté; 18,0 cm	Gomel dissection micro scissors; 18.0 cm	54
113 91 0539	Gomel nůžky mikro rovné; 14,5 cm	Gomel dissection micro scissors; 14.5 cm	54
113 91 0540	Gomel nůžky mikro rovné; 18,0 cm	Gomel dissection micro scissors; 18.0 cm	54
113 91 0552	Nůžky mikro; rovné 18,5 cm	Dissection micro scissors straight; 18.5 cm	54
113 91 0553	Nůžky mikro; zahnuté 18,5 cm	Dissection micro scissors curved; 18.5 cm	54
113 91 0573	Nůžky mikro; 25°; 18,0 cm	Micro scissors; 25°; 18.0 cm	53
113 91 0574	Nůžky mikro; 45°; 18,0 cm	Micro scissors; 45°; 18.0 cm	53
113 91 0575	Nůžky mikro; 60°; 18,0 cm	Micro scissors; 60°; 18.0 cm	53
113 91 0576	Nůžky mikro; 90°; 18,0 cm	Micro scissors; 90°; 18.0 cm	53
113 91 0577	Nůžky mikro; 125°; 18,0 cm	Micro scissors; 125°; 18.0 cm	53
113 91 0578	Nůžky mikro; 25°; 18,0 cm	Micro scissors; 25°; 18.0 cm	53
113 91 0579	Nůžky mikro; 45°; 18,0 cm	Micro scissors; 45°; 18.0 cm	53
113 91 0580	Nůžky mikro; 60°; 18,0 cm	Micro scissors; 60°; 18.0 cm	53
113 91 0581	Nůžky mikro; 90°; 18,0 cm	Micro scissors; 90°; 18.0 cm	53
113 91 0582	Nůžky mikro; 125°; 18,0 cm	Micro scissors; 125°; 18.0 cm	53

číslo – number	název	item	strana – page
113 91 0601	Mayo nůžky tupé rovné tvrdokovové; 14,5 cm	Mayo dissecting scissors straight TUC; 14.5 cm	62
113 91 0602	Mayo nůžky tupé rovné tvrdokovové; 17,0 cm	Mayo dissecting scissors straight TUC; 17.0 cm	62
113 91 0603	Mayo nůžky tupé rovné tvrdokovové; 23,0 cm	Mayo dissecting scissors straight TUC; 23.0 cm	62
113 91 0604	Mayo nůžky tupé zahnuté tvrdokovové; 14,5 cm	Mayo dissecting scissors curved TUC; 14.5 cm	62
113 91 0605	Mayo nůžky tupé zahnuté tvrdokovové; 17,0 cm	Mayo dissecting scissors curved TUC; 17.0 cm	62
113 91 0606	Mayo nůžky tupé zahnuté tvrdokovové; 23,0 cm	Mayo dissecting scissors curved TUC; 23.0 cm	62
113 91 0607	Parametrium nůžky zahnuté tvrdokovové; 22,5 cm	Parametrium scissors curved TUC; 22.5 cm	62
113 91 0608	Parametrium nůžky zahnuté tvrdokovové; 23,0 cm	Parametrium scissors curved TUC; 23.0 cm	62
113 91 0609	Mayo-Stille nůžky tupé rovné tvrdokovové; 15,0 cm	Mayo-Stille scissors straight TUC; 15.0 cm	63
113 91 0610	Mayo-Stille nůžky tupé rovné tvrdokovové; 17,0 cm	Mayo-Stille scissors straight TUC; 17.0 cm	63
113 91 0611	Mayo-Stille nůžky tupé zahnuté tvrdokovové; 18,0 cm	Mayo-Stille scissors curved TUC; 18.0 cm	63
113 91 0612	Mayo-Stille nůžky tupé zahnuté tvrdokovové; 17,0 cm	Mayo-Stille scissors curved TUC; 17.0 cm	63
113 91 0617	Metzenbaum nůžky tupé rovné tvrdokovové; 11,5 cm	Metzenbaum scissors straight TUC; 11.5 cm	63
113 91 0618	Metzenbaum nůžky tupé zahnuté tvrdokovové; 11,5 cm	Metzenbaum scissors curved TUC; 11.5 cm	63
113 91 0621	Metzenbaum nůžky tupé rovné tvrdokovové; 18,0 cm	Metzenbaum scissors straight TUC; 18.0 cm	64
113 91 0622	Metzenbaum nůžky tupé rovné tvrdokovové; 20,0 cm	Metzenbaum scissors straight TUC; 20.0 cm	64
113 91 0623	Metzenbaum nůžky tupé rovné tvrdokovové; 23,0 cm	Metzenbaum scissors straight TUC; 23.0 cm	64
113 91 0624	Metzenbaum nůžky tupé rovné tvrdokovové; 25,0 cm	Metzenbaum scissors straight TUC; 25.0 cm	64
113 91 0625	Metzenbaum nůžky tupé rovné tvrdokovové; 28,0 cm	Metzenbaum scissors straight TUC; 28.0 cm	64
113 91 0627	Metzenbaum nůžky tupé zahnuté tvrdokovové; 18,0 cm	Metzenbaum scissors curved TUC; 18.0 cm	64
113 91 0628	Metzenbaum nůžky tupé zahnuté tvrdokovové; 20,0 cm	Metzenbaum scissors curved TUC; 20.0 cm	64
113 91 0629	Metzenbaum nůžky tupé zahnuté tvrdokovové; 23,0 cm	Metzenbaum scissors curved TUC; 23.0 cm	64
113 91 0630	Metzenbaum nůžky tupé zahnuté tvrdokovové; 25,0 cm	Metzenbaum scissors curved TUC; 25.0 cm	64
113 91 0631	Metzenbaum nůžky tupé zahnuté tvrdokovové; 28,0 cm	Metzenbaum scissors curved TUC; 28.0 cm	64
113 91 0633	Potts-Smith nůžky tvrdokovové; 25°; 19,0 cm	Potts-Smith scissors TUC; 25°; 19.0 cm	65
113 91 0634	Potts-Smith nůžky tvrdokovové; 45°; 19,0 cm	Potts-Smith scissors TUC; 45°; 19.0 cm	65
113 91 0635	Potts-Smith nůžky tvrdokovové; 60°; 19,0 cm	Potts-Smith scissors TUC; 60°; 19.0 cm	65
113 91 0636	De Bakey nůžky tvrdokovové; 25°; 18,0 cm	De Bakey scissors TUC; 25°; 18.0 cm	65
113 91 0637	De Bakey nůžky tvrdokovové; 45°; 18,0 cm	De Bakey scissors TUC; 45°; 18.0 cm	65
113 91 0638	De Bakey nůžky tvrdokovové; 60°; 18,0 cm	De Bakey scissors TUC; 60°; 18.0 cm	65
113 91 0639	Lexer nůžky rovné tvrdokovové; 16,0 cm	Lexer scissors straight TUC; 16.0 cm	67
113 91 0640	Lexer nůžky zahnuté tvrdokovové; 16,0 cm	Lexer scissors curved TUC; 16.0 cm	67
113 91 0641	Metzenbaum-Delicate nůžky tupé rovné tvrdokov; 14,5 cm	Metzenbaum-Delicate scissors blunt straight TUC; 14.5 cm	65
113 91 0642	Metzenbaum-Delicate nůžky tupé zahnuté tvrdokov; 14,5 cm	Metzenbaum-Delicate scissors blunt curved TUC; 14.5 cm	65
113 91 0643	Metzenbaum-Delicate nůžky hrotnaté rovné tvrdokov; 14,5 cm	Metzenbaum-Delicate scissors sharp straight TUC; 14.5 cm	65
113 91 0644	Metzenbaum-Delicate nůžky hrotnaté zahnuté tvrdokov; 14,5 cm	Metzenbaum-Delicate scissors sharp curved TUC; 14.5 cm	65
113 91 0645	Metzenbaum-Delicate nůžky tupé rovné tvrdokov; 18,0 cm	Metzenbaum-Delicate scissors straight TUC; 18.0 cm	66
113 91 0646	Metzenbaum-Delicate nůžky tupé rovné tvrdokov; 20,0 cm	Metzenbaum-Delicate scissors straight TUC; 20.0 cm	66
113 91 0647	Metzenbaum-Delicate nůžky tupé rovné tvrdokov; 23,0 cm	Metzenbaum-Delicate scissors straight TUC; 23.0 cm	66
113 91 0648	Metzenbaum-Delicate nůžky tupé rovné tvrdokov; 25,0 cm	Metzenbaum-Delicate scissors straight TUC; 25.0 cm	66
113 91 0649	Metzenbaum-Delicate nůžky tupé rovné tvrdokov; 28,0 cm	Metzenbaum-Delicate scissors straight TUC; 28.0 cm	66
113 91 0650	Metzenbaum-Delicate nůžky tupé zahnuté tvrdokov; 18,0 cm	Metzenbaum-Delicate scissors curved TUC; 18.0 cm	66
113 91 0651	Metzenbaum-Delicate nůžky tupé zahnuté tvrdokov; 20,0 cm	Metzenbaum-Delicate scissors curved TUC; 20.0 cm	66
113 91 0652	Metzenbaum-Delicate nůžky tupé zahnuté tvrdokov; 23,0 cm	Metzenbaum-Delicate scissors curved TUC; 23.0 cm	66
113 91 0653	Metzenbaum-Delicate nůžky tupé zahnuté tvrdokov; 25,0 cm	Metzenbaum-Delicate scissors curved TUC; 25.0 cm	66
113 91 0654	Metzenbaum-Delicate nůžky tupé zahnuté tvrdokov; 28,0 cm	Metzenbaum-Delicate scissors curved TUC; 28.0 cm	66
113 91 0665	Toennis-Adson-Delicate nůžky jemné zahnuté tvrdokov; 17,5 cm	Toennis-Adson-Delicate scissors delicate TUC; 17.5 cm	67
113 91 0668	Nůžky na duhovku hrotnaté rovné tvrdokov; 11,5 cm	Iris scissors straight TUC; 11.5 cm	67
113 91 0669	Nůžky na duhovku hrotnaté zahnuté tvrdokov; 11,5 cm	Iris scissors curved TUC; 11.5 cm	67
113 91 0670	Universal nůžky na drát tvrdokov; 12,0 cm	Universal wire shears TUC; 12.0 cm	67
113 91 0671	Lister nůžky na obvazy tvrdokov; 18,0 cm	Lister bandage scissors TUC; 18.0 cm	67
113 91 0672	Nůžky mikro rovné; 25,0 cm	Endolaryngeal micro scissors straight; 25.0 cm	372
113 91 0673	Nůžky mikro zahnuté nahoru; 25,0 cm	Endolaryngeal micro scissors curved up; 25.0 cm	372
113 91 0674	Nůžky mikro zahnuté vpravo; 25,0 cm	Endolaryngeal micro scissors curved left; 25.0 cm	372
113 91 0675	Nůžky mikro zahnuté vlevo; 25,0 cm	Endolaryngeal micro scissors curved right; 25.0 cm	372
113 91 0676	Killian nůžky na septum; 20,0 cm	Killian septum scissors; 20.0 cm	372; 433
113 91 0677	Bellucci nůžky ušní rovné; 4,0 mm; 8,0 cm	Bellucci scissors straight; 4.0 mm; 8.0 cm	373
113 91 0678	Bellucci nůžky ušní zahnuté nahoru; 4,0 mm; 8,0 cm	Bellucci scissors curved up; 4.0 mm; 8.0 cm	373
113 91 0679	Bellucci nůžky ušní zahnuté vlevo; 4,0 mm; 8,0 cm	Bellucci scissors curved left; 4.0 mm; 8.0 cm	373
113 91 0680	Bellucci nůžky ušní zahnuté vpravo; 4,0 mm; 8,0 cm	Bellucci scissors curved right; 4.0 mm; 8.0 cm	373
113 91 0681	Wullstein nůžky ušní; 8,0 cm	Wullstein ear-scissors; 8.0 cm	373
113 91 0684	Hough nůžky nosní lomenné; 13,0 cm	Hough nasal scissors angled; 13.0 cm	48
113 91 0725	Nagel nůžky mikro 45°; 20,0 cm	Nagel micro scissors 45°; 20.0 cm	504
113 91 0726	Nůžky mikro 45°; 20,0 cm	Micro scissors 45° probe pointed; 20.0 cm	504
113 91 0727	Nůžky mikro 125°; 20,0 cm	Micro scissors 125°; 20.0 cm	504
113 91 0728	Nůžky mikro rovné; 16,0 cm	Micro scissors straight; 16.0 cm	505
113 91 0729	Nůžky mikro zahnuté; 16,0 cm	Micro scissors curved; 16.0 cm	505
113 91 0730	Vannas nůžky mikro rovné; 16,0 cm	Vannas micro scissors straight; 16.0 cm	505
113 91 0731	Vannas nůžky mikro zahnuté; 16,0 cm	Vannas micro scissors curved; 16.0 cm	505
113 91 0732	Millesi nůžky mikro rovné; 16,0 cm	Millesi micro scissors straight; 16.0 cm	505
113 91 0733	Millesi nůžky mikro zahnuté; 16,0 cm	Millesi micro scissors curved; 16.0 cm	505
113 91 0734	Mikro nůžky rovné; 18,5 cm	Micro scissors straight; 18.5 cm	506
113 91 0735	Mikro nůžky zahnuté; 19,0 cm	Micro scissors curved; 19.0 cm	506
113 91 0739	Mayo-Stille nůžky preparační tupé zahnuté SC; 17,0 cm	Mayo-Stille dissecting scissors curved blunt SC; 17.0 cm	59
113 91 0740	Metzenbaum-Nelson nůžky preparační tupé zahnuté SC; 20,0 cm	Metzenbaum-Nelson dissecting scissors curved SC; 20.0 cm	60
113 91 0741	Metzenbaum-Delicate nůžky preparační tupé zahnuté SC; 14,5 cm	Metzenbaum-Delicate dissecting scissors blunt curved SC; 14.5 cm	60
113 91 0742	Metzenbaum-Delicate nůžky preparační tupé zahnuté SC; 18,0 cm	Metzenbaum-Delicate dissecting scissors blunt curved SC; 18.0 cm	60
113 91 0743	Reynolds nůžky preparační hrotnaté rovné SC; 15,0 cm	Reynolds dissecting scissors SC; 15.0 cm	61
113 91 0745	Reynolds nůžky preparační hrotnaté rovné SC; 18,0 cm	Reynolds dissecting scissors SC; 18.0 cm	61
113 91 0746	Stevens nůžky oční tupé rovné SC; 11,5 cm	Stevens tenotomy scissors SC; 11.5 cm	61
113 91 0747	Stevens nůžky oční tupé zahnuté SC; 11,5 cm	Stevens tenotomy scissors SC; 11.5 cm	61
113 91 0748	Mayo nůžky preparační tupé rovné tvrdokov SC; 14,5 cm	Mayo dissecting scissors blunt straight TUC SC; 14.5 cm	68
113 91 0749	Mayo nůžky preparační tupé rovné tvrdokov SC; 17,0 cm	Mayo dissecting scissors blunt straight TUC SC; 17.0 cm	68
113 91 0750	Mayo nůžky preparační tupé zahnuté tvrdokov SC; 14,5 cm	Mayo dissecting scissors blunt curved TUC SC; 14.5 cm	68



číslo – number	název	item	strana – page
113 91 0751	Mayo nůžky preparační tupé zahnuté tvrdokov SC; 17,0 cm	Mayo dissecting scissors blunt curved TUC SC; 17.0 cm	68
113 91 0752	Mayo-Stille nůžky tupé rovné tvrdokovové SC; 15,0 cm	Mayo-Stille scissors blunt straight TUC SC; 15.0 cm	68
113 91 0753	Mayo-Stille nůžky tupé zahnuté tvrdokovové SC; 15,0 cm	Mayo-Stille scissors blunt curved TUC SC; 15.0 cm	68
113 91 0754	Metzenbaum nůžky tupé rovné tvrdokovové SC; 14,5 cm	Metzenbaum scissors blunt straight TUC SC; 14.5 cm	68
113 91 0767	Metzenbaum nůžky tupé zahnuté tvrdokovové SC; 14,5 cm	Metzenbaum scissors blunt curved TUC SC; 14.5 cm	68
113 91 0768	Metzenbaum nůžky tupé rovné tvrdokovové SC; 18,0 cm	Metzenbaum scissors blunt straight TUC SC; 18.0 cm	69
113 91 0769	Metzenbaum nůžky tupé rovné tvrdokovové SC; 20,0 cm	Metzenbaum scissors blunt straight TUC SC; 20.0 cm	69
113 91 0770	Metzenbaum nůžky tupé zahnuté tvrdokovové SC; 18,0 cm	Metzenbaum scissors blunt curved TUC SC; 18.0 cm	69
113 91 0771	Metzenbaum nůžky tupé zahnuté tvrdokovové SC; 20,0 cm	Metzenbaum scissors blunt curved TUC SC; 20.0 cm	69
113 91 0772	Metzenbaum nůžky tupé zahnuté tvrdokovové SC; 23,0 cm	Metzenbaum scissors blunt curved TUC SC; 23.0 cm	69
113 91 0773	Metzenbaum nůžky tupé zahnuté tvrdokovové SC; 25,0 cm	Metzenbaum scissors blunt curved TUC SC; 25.0 cm	69
113 91 0774	Metzenbaum-Delicate nůžky tupé rovné tvrdokovové SC; 14,5 cm	Metzenbaum-Delicate scissors blunt straight TUC SC; 14.5 cm	70
113 91 0775	Metzenbaum-Delicate nůžky tupé zahnuté tvrdokovové SC; 14,5 cm	Metzenbaum-Delicate scissors blunt curved TUC SC; 14.5 cm	70
113 91 0776	Metzenbaum-Delicate nůžky tupé rovné tvrdokovové SC; 18,0 cm	Metzenbaum-Delicate scissors blunt straight TUC SC; 18.0 cm	69
113 91 0777	Metzenbaum-Delicate nůžky tupé rovné tvrdokovové SC; 20,0 cm	Metzenbaum-Delicate scissors blunt straight TUC SC; 20.0 cm	69
113 91 0778	Metzenbaum-Delicate nůžky tupé zahnuté tvrdokovové SC; 18,0 cm	Metzenbaum-Delicate scissors blunt curved TUC SC; 18.0 cm	69
113 91 0779	Metzenbaum-Delicate nůžky tupé zahnuté tvrdokovové SC; 20,0 cm	Metzenbaum-Delicate scissors blunt curved TUC SC; 20.0 cm	69
113 91 0780	Stevens nůžky oční hrotnaté rovné tvrdokovové SC; 11,5 cm	Stevens tenotomy scissors pointed straight TUC SC; 11.5 cm	70
113 91 0781	Stevens nůžky oční hrotnaté zahnuté tvrdokovové SC; 11,5 cm	Stevens tenotomy scissors pointed curved TUC SC; 11.5 cm	70
113 91 0782	Nůžky na duhovku hrotnaté rovné tvrdokovové SC; 11,5 cm	Iris scissors straight sharp TUC SC; 11.5 cm	70
113 91 0783	Nůžky na duhovku hrotnaté zahnuté tvrdokovové SC; 11,5 cm	Iris scissors curved sharp TUC SC; 11.5 cm	70
114 02 0010	Kuehne pinzeta pro mikroskopická sklíčka; 10,5 cm	Kuehne clamp for microscopic slides; 10.5 cm	73
114 06 0010	Hegenbarth pinzeta svorkovací křížová; 12,0 cm	Hegenbarth forceps for clips; 12.0 cm	317
114 08 0030	Pinzeta anatomická; 16,0 cm	Dressing forceps; 16.0 cm	74
114 08 0040	Pinzeta anatomická; 20,0 cm	Dressing forceps; 20.0 cm	74
114 08 0050	Pinzeta anatomická; 25,0 cm	Dressing forceps; 25.0 cm	74
114 08 0060	Pinzeta anatomická; 30,0 cm	Dressing forceps; 30.0 cm	74
114 08 0090	Pinzeta anatomická hladká; 14,5 cm	Dressing forceps ; 14.5 cm	76
114 08 0101	Pinzeta anatomická jemná; 14,5 cm	Dressing forceps fine; 14.5 cm	76; 435
114 08 0140	Pinzeta anatomická jemná; 20,0 cm	Dressing forceps fine; 20.0 cm	76; 434
114 08 0231	Pinzeta anatomická velmi jemná; 14,5 cm	Dressing forceps very fine; 14.5 cm	76
114 08 0240	Pinzeta anatomická velmi jemná; 20,0 cm	Dressing forceps very fine; 20.0 cm	76
114 08 0250	Pinzeta anatomická velmi jemná; 25,0 cm	Dressing forceps very fine; 25.0 cm	76
114 08 0340	Pinzeta chirurgická; 1x2 zuby; 20,0 cm	Tissue forceps; 1x2 teeth; 20.0 cm	74
114 08 0350	Pinzeta chirurgická; 1x2 zuby; 25,0 cm	Tissue forceps; 1x2 teeth; 25.0 cm	74
114 08 0360	Pinzeta chirurgická; 1x2 zuby; 30,0 cm	Tissue forceps; 1x2 teeth; 30.0 cm	74
114 08 0381	Pinzeta chirurgická; 1x2 zuby; 14,5 cm	Tissue forceps; 1x2 teeth; 14.5 cm	74
114 08 0430	Pinzeta chirurgická jemná; 1x2 zuby; 16,0 cm	Tissue forceps fine; 1x2 teeth; 16.0 cm	74
114 08 0530	Pinzeta chirurgická velmi jemná; 1x2 zuby; 14,5 cm	Tissue forceps very fine; 1x2 teeth; 14.5 cm	77; 433; 435
114 08 0540	Pinzeta chirurgická velmi jemná; 1x2 zuby; 20,0 cm	Tissue forceps very fine; 1x2 teeth; 20.0 cm	77
114 08 0620	Pinzeta chirurgická; 3x4 zuby; 14,0 cm	Tissue forceps; 3x4 teeth; 14.0 cm	77; 435
114 08 0660	Pinzeta chirurgická; 4x5 zubů; 14,0 cm	Tissue forceps; 4x5 teeth; 14.0 cm	77
114 08 0980	Pinzeta na třísky; 14,0 cm	Splinter forceps; 14.0 cm	84; 433
114 08 1020	Pinzeta technická; 13,5 cm	Technical forceps; 13.5 cm	84
114 08 1030	Pinzeta technická; 19,0 cm	Technical forceps; 19.0 cm	84
114 08 1040	Pinzeta technická; 24,0 cm	Technical forceps; 24.0 cm	84
114 12 0010	Pinzeta na plastiku šicí; 6x5 zubů; 14,0 cm	Suturing forceps; 6x5 teeth; 14.0 cm	73
114 12 0020	Pinzeta jemná šicí; 20,0 cm	Suturing forceps; 20.0 cm	73
114 12 0030	Pinzeta na plastiku šicí; 3x4 zuby; 11,0 cm	Suturing forceps; 3x4 teeth; 11.0 cm	73
114 12 0090	Pinzeta epilační široká; 13,0 cm	Depilation forceps; 13.0 cm	73
114 12 0100	Pinzeta epilační; 14,0 cm	Depilation forceps; 14.0 cm	73
114 14 0100	Pinzeta cévní atraumatická rovná; 2,0 mm; 14,5 cm	Non-traumatic forceps; 2.0 mm; 14.5 cm	90
114 14 0110	Pinzeta cévní atraumatická rovná; 2,0 mm; 20,0 cm	Non-traumatic forceps; 2.0 mm; 20.0 cm	90
114 14 0120	Pinzeta cévní atraumatická zahnutá; 2,0 mm; 20,0 cm	Non-traumatic forceps; 2.0 mm; 20.0 cm	90
114 14 0130	Pinzeta cévní atraumatická; 3,5 mm; 20,0 cm	Non-traumatic forceps; 3.5 mm; 20.0 cm	90
114 14 0140	Pinzeta cévní atraumatická; 3,5 mm; 24,8 cm	Non-traumatic forceps; 3.5 mm; 24.8 cm	90
114 14 0300	Pinzeta cévní atraumatická rovná jemná; 14,5 cm	Non-traumatic forceps; 14.5 cm	90
114 29 0010	Troeltsch pinzeta ušní jemná; 11,0 cm	Troeltsch ear forceps; 11.0 cm	85
114 29 0020	Troeltsch pinzeta ušní; 11,0 cm	Troeltsch ear forceps; 11.0 cm	85
114 29 0030	Lucae pinzeta ušní bajonetová anatomická; 14,5 cm	Lucae ear anatomical forceps; 14.5 cm	85
114 30 0010	Troeltsch pinzeta nosní jemná; 16,0 cm	Troeltsch nasal forceps; 16.0 cm	85; 432
114 30 0020	Troeltsch pinzeta nosní; 18,0 cm	Troeltsch nasal forceps; 18.0 cm	85
114 30 0040	Pinzeta anatomická bajonetová; 18,0 cm	Anatomical forceps; 18.0 cm	85
114 32 0010	Maršik pinzeta na mandle; 22,8 cm	Maršik tonsil forceps; 22.8 cm	85; 434
114 38 0010	Graefe pinzeta oční rovná; 10,5 cm	Graefe eye forceps straight; 10.5 cm	86
114 38 0020	Graefe pinzeta oční rovná jemná; 10,5 cm	Graefe eye forceps straight; 10.5 cm	86
114 38 0030	Graefe pinzeta oční rovná nemagnetická; 10,5 cm	Graefe eye forceps straight non-magnetic; 10.5 cm	86
114 38 0040	Graefe pinzeta oční rovná nemagnetická jemná; 10,5 cm	Graefe eye forceps straight non-magnetic; 10.5 cm	86
114 38 0100	Graefe pinzeta oční zahnutá jemná; 10,5 cm	Graefe eye forceps curved; 10.5 cm	86
114 38 0110	Graefe pinzeta oční silně zahnutá; 10,0 cm	Graefe eye forceps curved; 10.0 cm	86
114 38 0120	Graefe pinzeta oční silně zahnutá nemagnetická; 10,0 cm	Graefe eye forceps curved non-magnetic; 10.0 cm	86
114 38 0150	Graefe pinzeta oční rovná; 1x2 zuby; 10,5 cm	Graefe eye forceps straight; 1x2 teeth; 10.5 cm	86
114 38 0160	Graefe pinzeta oční rovná jemná; 1x2 zuby; 10,5 cm	Graefe eye forceps straight; 1x2 teeth; 10.5 cm	86; 433
114 38 0170	Graefe pinzeta oční rovná nemagnetická; 1x2 zuby; 10,5 cm	Graefe eye forceps straight; 1x2 teeth; 10.5 cm	86
114 38 0200	Graefe pinzeta oční zahnutá; 1x2 zuby; 10,5 cm	Graefe eye forceps curved; 1x2 teeth; 10.5 cm	86
114 38 0210	Graefe pinzeta oční silně zahnutá nemagnetická; 1x2 zuby; 10,0 cm	Graefe eye forceps curved; 1x2 teeth; 10.0 cm	86
114 38 0230	Koutný pinzeta na duhovku zahnutá; 10,0 cm	Koutný iris forceps curved; 10.0 cm	88
114 38 0250	Pinzeta na duhovku anatomická; 5,0 cm	Iris forceps; 5.0 cm	87
114 38 0270	Pinzeta na duhovku chirurgická zahnutá; 5,0 cm	Iris forceps curved; 5.0 cm	87
114 38 0350	Graefe pinzeta fixační; 11,0 cm	Graefe fixation forceps; 11.0 cm	87
114 38 0360	Graefe pinzeta fixační s uzávěrem s perem; 11,0 cm	Graefe fixation forceps; 11.0 cm	87
114 38 0370	Elschnig pinzeta fixační; 10,5 cm	Elschnig fixation forceps; 10.5 cm	87
114 38 0590	Kuhnt pinzeta na čočkové pouzdro; 10,0 cm	Kuhnt capsule forceps; 10.0 cm	88
114 38 0720	Kolibri pinzeta na duhovku šicí; 8,0 cm	Kolibri iris forceps; 8.0 cm	89

číslo – number	název	item	strana – page
114 38 0750	Pinzeta enukleační 4x5 zubů; 14,0 cm	Enucleation forceps; 14.0 cm	87
114 38 0830	Blascovics pinzeta na operaci šilhání se šroubem pr.; 9,5 cm	Blascovics strabismus forceps; 9.5 cm	88
114 38 0840	Blascovics pinzeta na operaci šilhání se šroubem lev.; 9,5 cm	Blascovics strabismus forceps; 9.5 cm	88
114 38 0850	Castroviejo pinzeta na rohovku; 10,0 cm	Castroviejo corneal forceps; 10.0 cm	89
114 38 0860	Pinzeta na rohovku šicí rovná; 10,0 cm	Corneal suturing forceps; 10.0 cm	89
114 38 0870	Pinzeta na rohovku zahnutá; 10,0 cm	Corneal suturing forceps; 10.0 cm	89
114 38 0910	Desmarres pinzeta na chalazia fig.1	Desmarres chalazion forceps fig.1	88
114 38 0920	Desmarres pinzeta na chalazia fig.2	Desmarres chalazion forceps fig.2	88
114 38 0930	Desmarres pinzeta na chalazia fig.3	Desmarres chalazion forceps fig.3	88
114 38 0960	Lambert pinzeta na chalazia kulatá; 9,0 cm	Lambert chalazion forceps rounded; 9.0 cm	88
114 38 1110	Beer pinzeta na řasy; 3 mm; 8,5 cm	Beer cilia forceps; 3 mm; 8.5 cm	89
114 38 1120	Beer pinzeta na řasy; 4,5 mm; 8,5 cm	Beer cilia forceps; 4.5 mm; 8.5 cm	89
114 38 1170	Pinzeta na řasy zkosená; 8,5 cm	Cilia forceps; 8.5 cm	89
114 38 1230	Pinzeta na keratoplastiku vidlič. lomená; 8,5 cm	Keratoplastic forceps; 8.5 cm	89
114 38 1300	Kolibri pinzeta na duhovku mikro; 8,0 cm	Kolibri iris micro forceps; 8.0 cm	89
114 38 1310	Pinzeta šicí rovná hladká; 8,5 cm	Suturing forceps; 8.5 cm	89
114 38 1320	Pinzeta šicí rovná háčková; 8,5 cm	Suturing forceps; 8.5 cm	89
114 38 1330	Pinzeta šicí prohnutá háčková; 8,0 cm	Suturing forceps; 8.0 cm	89
114 91 0002	Pinzeta anatomická rovná; 11,5 cm	Standard dressing forceps; 11.5 cm	74
114 91 0003	Pinzeta anatomická rovná; 13,0 cm	Standard dressing forceps; 13.0 cm	74
114 91 0004	Pinzeta anatomická rovná; 14,5 cm	Standard dressing forceps; 14.5 cm	74
114 91 0006	Pinzeta anatomická rovná; 18,0 cm	Standard dressing forceps; 18.0 cm	74
114 91 0011	Pinzeta chirurgická rovná; 1x2 zuby; 11,5 cm	Standard tissue forceps; 1x2 teeth; 11.5 cm	74
114 91 0012	Pinzeta chirurgická rovná; 1x2 zuby; 13,0 cm	Standard tissue forceps; 1x2 teeth; 13.0 cm	74
114 91 0015	Pinzeta chirurgická rovná; 1x2 zuby; 18,0 cm	Standard tissue forceps; 1x2 teeth; 18.0 cm	74
114 91 0019	Pinzeta chirurgická rovná; 2x3 zuby; 13,0 cm	Tissue forceps; 2x3 teeth; 13.0 cm	75
114 91 0020	Pinzeta chirurgická rovná; 2x3 zuby; 14,5 cm	Tissue forceps; 2x3 teeth; 14.5 cm	75
114 91 0021	Pinzeta chirurgická rovná; 2x3 zuby; 16,0 cm	Tissue forceps; 2x3 teeth; 16.0 cm	75
114 91 0022	Pinzeta chirurgická rovná; 2x3 zuby; 18,0 cm	Tissue forceps; 2x3 teeth; 18.0 cm	75
114 91 0023	Pinzeta chirurgická rovná; 2x3 zuby; 20,0 cm	Tissue forceps; 2x3 teeth; 20.0 cm	75
114 91 0024	Pinzeta chirurgická rovná; 2x3 zuby; 25,0 cm	Tissue forceps; 2x3 teeth; 25.0 cm	75
114 91 0026	Pinzeta chirurgická rovná; 3x4 zuby; 13,0 cm	Tissue forceps; 3x4 teeth; 13.0 cm	75
114 91 0027	Pinzeta chirurgická rovná; 3x4 zuby; 14,5 cm	Tissue forceps; 3x4 teeth; 14.5 cm	75
114 91 0028	Pinzeta chirurgická rovná; 3x4 zuby; 16,0 cm	Tissue forceps; 3x4 teeth; 16.0 cm	75
114 91 0029	Pinzeta chirurgická rovná; 4x5 zubů; 13,0 cm	Tissue forceps; 4x5 teeth; 13.0 cm	75
114 91 0030	Pinzeta chirurgická rovná; 4x5 zubů; 14,5 cm	Tissue forceps; 4x5 teeth; 14.5 cm	75
114 91 0031	Pinzeta chirurgická rovná; 4x5 zubů; 16,0 cm	Tissue forceps; 4x5 teeth; 16.0 cm	75
114 91 0033	Pinzeta anatomická úzká; 11,5 cm	Dressing forceps; 11.5 cm	75
114 91 0034	Pinzeta anatomická úzká; 13,0 cm	Dressing forceps; 13.0 cm	75
114 91 0036	Pinzeta anatomická úzká; 16,0 cm	Dressing forceps; 16.0 cm	75
114 91 0037	Pinzeta anatomická úzká; 18,0 cm	Dressing forceps; 18.0 cm	75
114 91 0038	Pinzeta anatomická úzká; 20,0 cm	Dressing forceps; 20.0 cm	75
114 91 0039	Pinzeta anatomická úzká; 25,0 cm	Dressing forceps; 25.0 cm	75
114 91 0040	Pinzeta anatomická úzká; 30,0 cm	Dressing forceps; 30.0 cm	75
114 91 0105	Adson pinzeta anatomická; 12,0 cm	Adson dressing forceps; 12.0 cm	78
114 91 0107	Adson pinzeta anatomická; 15,0 cm	Adson dressing forceps; 15.0 cm	78
114 91 0108	Micro-Adson pinzeta anatomická; 12,0 cm	Micro-Adson dressing forceps; 12.0 cm	78
114 91 0111	Adson pinzeta chirurgická; 1x2 zuby; 12,0 cm	Adson tissue forceps; 1x2 teeth; 12.0 cm	78
114 91 0113	Adson pinzeta chirurgická; 1x2 zuby; 15,0 cm	Adson tissue forceps; 1x2 teeth; 15.0 cm	78
114 91 0114	Micro-Adson pinzeta chirurgická; 1x2 zuby; 12,0 cm	Micro-Adson tissue forceps; 1x2 teeth; 12.0 cm	78
114 91 0119	Adson-Brown pinzeta chirurgická rovná; 7x7 zuby; 12,0 cm	Adson-Brown tissue forceps; 7x7 teeth; 12.0 cm	78
114 91 0126	McIndoe pinzeta anatomická; 15,0 cm	McIndoe dressing forceps; 15.0 cm	78
114 91 0128	Semken pinzeta anatomická rovná; 12,5 cm	Semken dressing forceps; 12.5 cm	78
114 91 0129	Semken pinzeta anatomická rovná; 15,5 cm	Semken dressing forceps; 15.5 cm	78
114 91 0132	Semken pinzeta chirurgická rovná; 1x2 zuby; 12,5 cm	Semken tissue forceps; 1x2 teeth; 12.5 cm	78
114 91 0133	Semken pinzeta chirurgická rovná; 1x2 zuby; 15,5 cm	Semken tissue forceps; 1x2 teeth; 15.5 cm	78
114 91 0138	Taylor pinzeta anatomická rovná; 17,5 cm	Taylor dressing forceps with dissector; 17.5 cm	79
114 91 0139	Taylor pinzeta anatomická bajonetová; 17,5 cm	Taylor dressing forceps with dissector; 17.5 cm	79; 433
114 91 0142	Taylor pinzeta chirurgická rovná; 1x2 zuby 17,5 cm	Taylor tissue forceps with dissector; 1x2 teeth; 17.5 cm	79
114 91 0143	Taylor pinzeta chirurgická bajonetová; 17,5 cm	Taylor tissue forceps with dissector; 17.5 cm	79
114 91 0144	Lane pinzeta chirurgická; 1x2 zuby; 14,5 cm	Lane tissue forceps; 1x2 teeth; 14.5 cm	79
114 91 0146	Lane pinzeta chirurgická; 2x3 zuby; 14,5 cm	Lane tissue forceps; 2x3 teeth; 14.5 cm	79
114 91 0148	Gerald pinzeta anatomická rovná; 18,0 cm	Gerald dressing forceps straight; 18.0 cm	80
114 91 0149	Gerald pinzeta anatomická zahnutá; 18,0 cm	Gerald dressing forceps curved; 18.0 cm	80
114 91 0150	Gerald pinzeta chirurgická rovná; 1x2 zuby; 17,0 cm	Gerald tissue forceps straight; 1x2 teeth; 17.0 cm	80
114 91 0151	Gerald pinzeta chirurgická zahnutá; 1x2 zuby; 17,0 cm	Gerald tissue forceps curved; 1x2 teeth; 17.0 cm	80
114 91 0152	Cushing pinzeta anatomická rovná; 17,5 cm	Cushing dressing forceps; 17.5 cm	79
114 91 0154	Cushing pinzeta chirurgická rovná; 1x2 zuby; 17,5 cm	Cushing tissue forceps; 1x2 teeth; 17.5 cm	79
114 91 0156	Potts-Smith pinzeta anatomická rovná; 18,0 cm	Potts-Smith dressing forceps; 18.0 cm	80
114 91 0157	Potts-Smith pinzeta anatomická rovná; 21,0 cm	Potts-Smith dressing forceps; 21.0 cm	80
114 91 0158	Potts-Smith pinzeta anatomická rovná; 25,0 cm	Potts-Smith dressing forceps; 25.0 cm	80
114 91 0162	Potts-Smith pinzeta chirurgická rovná; 1x2 zuby; 18,0 cm	Potts-Smith tissue forceps; 1x2 teeth; 18.0 cm	80
114 91 0163	Potts-Smith pinzeta chirurgická rovná; 1x2 zuby; 21,0 cm	Potts-Smith tissue forceps; 1x2 teeth; 21.0 cm	80
114 91 0164	Potts-Smith pinzeta chirurgická rovná; 1x2 zuby; 25,0 cm	Potts-Smith tissue forceps; 1x2 teeth; 25.0 cm	80
114 91 0172	Brown pinzeta chirurgická; 15,0 cm	Brown tissue forceps; 15.0 cm	80
114 91 0173	Brown pinzeta chirurgická; 20,0 cm	Brown tissue forceps; 20.0 cm	80
114 91 0174	Brown pinzeta chirurgická; 25,0 cm	Brown tissue forceps; 25.0 cm	80
114 91 0179	Wangensteen pinzeta anatomická; 23,0 cm	Wangensteen dressing forceps; 23.0 cm	81
114 91 0180	Stille-Barraya pinzeta chirurgická; 3x4 zuby; 18,0 cm	Stille-Barraya tissue forceps; 3x4 teeth; 18.0 cm	81
114 91 0181	Stille-Barraya pinzeta chirurgická; 3x4 zuby; 20,0 cm	Stille-Barraya tissue forceps; 3x4 teeth; 20.0 cm	81; 434
114 91 0182	Stille-Barraya pinzeta chirurgická; 3x4 zuby; 25,0 cm	Stille-Barraya tissue forceps; 3x4 teeth; 25.0 cm	81
114 91 0183	Ferris-Smith pinzeta chirurgická; 2x3 zuby; 18,0 cm	Ferris-Smith tissue forceps; 2x3 teeth; 18.0 cm	81
114 91 0190	Adlerkreutz pinzeta chirurgická; 4x5 zuby; 15,0 cm	Adlerkreutz tissue forceps; 4x5 teeth; 15.0 cm	81
114 91 0191	Adlerkreutz pinzeta chirurgická; 4x5 zuby; 20,0 cm	Adlerkreutz tissue forceps; 4x5 teeth; 20.0 cm	81

číslo – number	název	item	strana – page
114 91 0193	Collin-Duval pinzeta úchopná; 14 mm; 20,0 cm	Collin-Duval grasping forceps; 14 mm; 20.0 cm	81
114 91 0198	Singley-Tuttle pinzeta; 23,0 cm	Singley-Tuttle forceps; 23.0 cm	82
114 91 0199	Nelson pinzeta úchopná; 23,0 cm	Nelson grasping forceps; 23.0 cm	82
114 91 0200	Gillies pinzeta chirurgická; 1×2 zuby; 15,0 cm	Gillies tissue forceps; 1×2 teeth; 15.0 cm	82
114 91 0208	Russ. Modell pinzeta chirurgická; 15,0 cm	Russ. Modell tissue forceps; 15.0 cm	82
114 91 0209	Russ. Modell pinzeta chirurgická; 20,0 cm	Russ. Modell tissue forceps; 20.0 cm	82
114 91 0210	Russ. Modell pinzeta chirurgická; 25,0 cm	Russ. Modell tissue forceps; 25.0 cm	82
114 91 0211	Durante pinzeta chirurgická; 14,5 cm	Durante tissue forceps; 14.5 cm	82
114 91 0212	Durante pinzeta chirurgická; 16,0 cm	Durante tissue forceps; 16.0 cm	82
114 91 0213	Durante pinzeta chirurgická; 20,0 cm	Durante tissue forceps; 20.0 cm	82
114 91 0214	Duval pinzeta chirurgická; 14,5 cm	Duval tissue forceps; 14.5 cm	82
114 91 0215	Bonney pinzeta chirurgická; 1×2 zuby; 18,0 cm	Bonney tissue forceps; 1×2 teeth; 18.0 cm	82
114 91 0216	Bonney pinzeta chirurgická; 2×3 zuby; 18,0 cm	Bonney tissue forceps; 2×3 teeth; 18.0 cm	82
114 91 0228	Yasargil pinzeta na nádory; 3 mm dia; 22,0 cm	Yasargil tumor forceps; 3 mm dia; 22.0 cm	83
114 91 0229	Yasargil pinzeta na nádory; 5 mm dia; 22,0 cm	Yasargil tumor forceps; 5 mm dia; 22.0 cm	83
114 91 0230	Yasargil pinzeta na nádory; 3 mm dia; 22,0 cm	Yasargil tumor forceps; 3 mm dia; 22.0 cm	83
114 91 0231	Yasargil pinzeta na nádory; 5 mm dia; 22,0 cm	Yasargil tumor forceps; 5 mm dia; 22.0 cm	83
114 91 0255	Pinzeta šicí rovná; 0,3 mm; 12,0 cm	Suture tying forceps straight; 0.3 mm; 12.0 cm	83
114 91 0256	Pinzeta šicí rovná; 0,3 mm; 15,0 cm	Suture tying forceps straight; 0.3 mm; 15.0 cm	83
114 91 0257	Pinzeta šicí zahnutá; 0,3 mm; 12,0 cm	Suture tying forceps curved; 0.3 mm; 12.0 cm	83
114 91 0258	Pinzeta šicí zahnutá; 0,3 mm; 15,0 cm	Suture tying forceps curved; 0.3 mm; 15.0 cm	83
114 91 0259	Pinzeta šicí rovná; 0,3 mm; 18,0 cm	Suture tying forceps straight; 0.3 mm; 18.0 cm	83
114 91 0260	Pinzeta šicí zahnutá; 0,3 mm; 18,0 cm	Suture tying forceps curved; 0.3 mm; 18.0 cm	83
114 91 0318	Stieglitz pinzeta na třísky rovná; 13,5 cm	Stieglitz splinter forceps straight; 13.5 cm	84
114 91 0319	Stieglitz pinzeta na třísky zahnutá; 13,5 cm	Stieglitz splinter forceps curved; 13.5 cm	84
114 91 0323	Peet pinzeta na třísky zahnutá; 11,5 cm	Peet splinter forceps curved; 11.5 cm	84
114 91 0366	Graefe pinzeta oční rovná; 10,0 cm	Graefe eye forceps straight; 10.0 cm	86
114 91 0368	Graefe pinzeta oční mírně zahnutá; 10,0 cm	Graefe eye forceps curved; 10.0 cm	86
114 91 0372	Graefe pinzeta oční rovná; 1×2 zuby; 10,0 cm	Graefe eye forceps straight; 1×2 teeth; 10.0 cm	86
114 91 0374	Graefe pinzeta oční mírně zahnutá; 1×2 zuby; 10,0 cm	Graefe eye forceps curved; 1×2 teeth; 10.0 cm	86
114 91 0451	De Bakey pinzeta atraumatická rovná; 1,5 mm; 16,0 cm	De Bakey atrauma forceps straight; 1.5 mm; 16.0 cm	91
114 91 0453	De Bakey pinzeta atraumatická rovná; 1,5 mm; 20,0 cm	De Bakey atrauma forceps straight; 1.5 mm; 20.0 cm	91
114 91 0454	De Bakey pinzeta atraumatická rovná; 1,5 mm; 24,0 cm	De Bakey atrauma forceps straight; 1.5 mm; 24.0 cm	91
114 91 0455	De Bakey pinzeta atraumatická rovná; 2,0 mm; 16,0 cm	De Bakey atrauma forceps straight; 2.0 mm; 16.0 cm	91
114 91 0457	De Bakey pinzeta atraumatická rovná; 2,0 mm; 20,0 cm	De Bakey atrauma forceps straight; 2.0 mm; 20.0 cm	91
114 91 0458	De Bakey pinzeta atraumatická rovná; 2,0 mm; 24,0 cm	De Bakey atrauma forceps straight; 2.0 mm; 24.0 cm	91
114 91 0459	De Bakey pinzeta atraumatická rovná; 2,0 mm; 30,0 cm	De Bakey atrauma forceps straight; 2.0 mm; 30.0 cm	91
114 91 0460	De Bakey pinzeta atraumatická rovná; 2,8 mm; 16,0 cm	De Bakey atrauma forceps straight; 2.8 mm; 16.0 cm	91
114 91 0461	De Bakey pinzeta atraumatická rovná; 2,8 mm; 20,0 cm	De Bakey atrauma forceps straight; 2.8 mm; 20.0 cm	91
114 91 0462	De Bakey pinzeta atraumatická rovná; 2,8 mm; 24,0 cm	De Bakey atrauma forceps straight; 2.8 mm; 24.0 cm	91
114 91 0463	De Bakey pinzeta atraumatická rovná; 2,8 mm; 30,0 cm	De Bakey atrauma forceps straight; 2.8 mm; 30.0 cm	91
114 91 0464	De Bakey pinzeta atraumatická rovná; 3,5 mm; 20,0 cm	De Bakey atrauma forceps straight; 3.5 mm; 20.0 cm	91
114 91 0465	De Bakey pinzeta atraumatická rovná; 3,5 mm; 24,0 cm	De Bakey atrauma forceps straight; 3.5 mm; 24.0 cm	91
114 91 0466	De Bakey pinzeta atraumatická rovná; 3,5 mm; 30,0 cm	De Bakey atrauma forceps straight; 3.5 mm; 30.0 cm	91
114 91 0467	De Bakey pinzeta atraumatická zahnutá; 2,0 mm; 16,0 cm	De Bakey atrauma forceps curved; 2.0 mm; 16.0 cm	91
114 91 0468	De Bakey pinzeta atraumatická rovná; 3,5 mm; 15,0 cm	De Bakey atrauma forceps straight; 3.5 mm; 15.0 cm	91
114 91 0469	De Bakey pinzeta atraumatická zahnutá; 2,0 mm; 20,0 cm	De Bakey atrauma forceps curved; 2.0 mm; 20.0 cm	91
114 91 0470	De Bakey pinzeta atraumatická zahnutá; 2,0 mm; 24,0 cm	De Bakey atrauma forceps curved; 2.0 mm; 24.0 cm	91
114 91 0471	De Bakey pinzeta atraumatická zahnutá; 2,0 mm; 30,0 cm	De Bakey atrauma forceps curved; 2.0 mm; 30.0 cm	91
114 91 0472	Pinzeta anatomická tvrdokov; 15,0 cm	Dressing forceps TUC; 15.0 cm	92
114 91 0473	Pinzeta anatomická tvrdokov; 18,0 cm	Dressing forceps TUC; 18.0 cm	92
114 91 0474	Pinzeta anatomická tvrdokov; 20,0 cm	Dressing forceps TUC; 20.0 cm	92
114 91 0475	Pinzeta anatomická tvrdokov; 23,0 cm	Dressing forceps TUC; 23.0 cm	92
114 91 0476	Pinzeta anatomická tvrdokov; 25,0 cm	Dressing forceps TUC; 25.0 cm	92
114 91 0477	Oehler pinzeta chirurgická tvrdokov; 1×2 zuby; 14,0 cm	Oehler tissue forceps TUC; 1×2 teeth; 14.0 cm	92
114 91 0478	Oehler pinzeta chirurgická tvrdokov; 1×2 zuby; 16,0 cm	Oehler tissue forceps TUC; 1×2 teeth; 16.0 cm	92
114 91 0479	Oehler pinzeta chirurgická tvrdokov; 1×2 zuby; 18,0 cm	Oehler tissue forceps TUC; 1×2 teeth; 18.0 cm	92
114 91 0480	Oehler pinzeta chirurgická tvrdokov; 1×2 zuby; 20,0 cm	Oehler tissue forceps TUC; 1×2 teeth; 20.0 cm	92
114 91 0481	Oehler pinzeta chirurgická tvrdokov; 1×2 zuby; 25,0 cm	Oehler tissue forceps TUC; 1×2 teeth; 25.0 cm	92
114 91 0482	Oehler pinzeta chirurgická tvrdokov; 1×2 zuby; 30,0 cm	Oehler tissue forceps TUC; 1×2 teeth; 30.0 cm	92
114 91 0483	Semken pinzeta anatomická tvrdokov; 12,5 cm	Semken dissecting forceps TUC; 12.5 cm	92
114 91 0484	Semken pinzeta anatomická tvrdokov; 15,5 cm	Semken dissecting forceps TUC; 15.5 cm	92
114 91 0485	Gillies pinzeta chirurgická tvrdokov; 1×2 zuby; 15,0 cm	Gillies tissue forceps TUC; 1×2 teeth; 15.0 cm	92
114 91 0486	Jeweler pinzeta tvrdokov; 15,0 cm	Jeweler forceps TUC; 15.0 cm	92
114 91 0487	Adson pinzeta anatomická tvrdokov; 12,0 cm	Adson forceps TUC; 12.0 cm	93
114 91 0489	Adson pinzeta anatomická tvrdokov; 15,0 cm	Adson forceps TUC; 15.0 cm	93
114 91 0490	Adson pinzeta chirurgická tvrdokov; 1×2 zuby; 12,0 cm	Adson forceps TUC; 1×2 teeth; 12.0 cm	93
114 91 0491	Adson pinzeta chirurgická tvrdokov; 1×2 zuby; 15,0 cm	Adson forceps TUC; 1×2 teeth; 15.0 cm	93
114 91 0492	Cushing pinzeta anatomická tvrdokov; 17,5 cm	Cushing forceps TUC; 17.5 cm	93
114 91 0493	Cushing pinzeta anatomická tvrdokov; 18,0 cm	Cushing forceps TUC; 18.0 cm	93
114 91 0494	Cushing-Taylor pinzeta tvrdokov; 18,0 cm	Cushing-Taylor forceps TUC; 18.0 cm	93
114 91 0495	De Bakey pinzeta atraumatická tvrdokov; 1,5 mm; 16,0 cm	De Bakey atrauma forceps TUC; 1.5 mm; 16.0 cm	93
114 91 0496	De Bakey pinzeta atraumatická tvrdokov; 1,5 mm; 20,0 cm	De Bakey atrauma forceps TUC; 1.5 mm; 20.0 cm	93
114 91 0497	De Bakey pinzeta atraumatická tvrdokov; 1,5 mm; 24,0 cm	De Bakey atrauma forceps TUC; 1.5 mm; 24.0 cm	93
114 91 0498	De Bakey pinzeta atraumatická tvrdokov; 2,0 mm; 16,0 cm	De Bakey atrauma forceps TUC; 2.0 mm; 16.0 cm	93
114 91 0499	De Bakey pinzeta atraumatická tvrdokov; 2,0 mm; 20,0 cm	De Bakey atrauma forceps TUC; 2.0 mm; 20.0 cm	93
114 91 0500	De Bakey pinzeta atraumatická tvrdokov; 2,0 mm; 24,0 cm	De Bakey atrauma forceps TUC; 2.0 mm; 24.0 cm	93
114 91 0501	Bonney pinzeta chirurgická tvrdokov; 1×2 zuby; 18,0 cm	Bonney tissue forceps TUC; 1×2 teeth; 18.0 cm	93
114 91 0502	Wangensteen pinzeta chirurgická tvrdokov; 15,0 cm	Wangensteen tissue forceps TUC; 15.0 cm	93
114 91 0503	Wangensteen pinzeta chirurgická tvrdokov; 23,0 cm	Wangensteen tissue forceps TUC; 23.0 cm	93
114 91 0563	Pinzeta mikro; 0,6 mm; 18,0 cm	Micro forceps 0.6 mm; 18.0 cm	507
114 91 0564	Pinzeta mikro; 0,9 mm; 18,0 cm	Micro forceps 0.9 mm; 18.0 cm	507
114 91 0565	Pinzeta mikro; 1×2 zuby; 18,0 cm	Micro forceps 1×2 teeth; 18.0 cm	507
114 91 0566	Pinzeta mikro; 0,6 mm; 20,0 cm	Micro forceps 0.6 mm; 20.0 cm	507



číslo – number	název	item	strana – page
114 91 0567	Pinzeta mikro; 0,9 mm; 20,0 cm	Micro forceps 0.9 mm; 20.0 cm	507
114 91 0568	Pinzeta mikro; 0,6 mm; 22,0 cm	Micro forceps 0.6 mm; 22.0 cm	507
114 91 0569	Pinzeta mikro; 0,9 mm; 22,0 cm	Micro forceps 0.9 mm; 22.0 cm	507
114 91 0570	Pinzeta mikro; 0,6 mm; 24,0 cm	Micro forceps 0.6 mm; 24.0 cm	507
114 91 0571	Pinzeta mikro; 0,9 mm; 24,0 cm	Micro forceps 0.9 mm; 24.0 cm	507
114 91 0572	Pinzeta mikro; 18,5 cm	Micro forceps; 18.5 cm	508
114 91 0573	Pinzeta mikro; 18,5 cm	Micro forceps; 18.5 cm	508
114 91 0574	Pinzeta mikro; 18,5 cm	Micro forceps; 18.5 cm	508
114 91 0575	Pinzeta šicí rovná; 22,0 cm	Suture forceps straight; 22.0 cm	508
114 91 0576	Pinzeta šicí zahnutá; 18,5 cm	Suture forceps curved; 18.5 cm	508
114 91 0577	Diethrich pinzeta mikro Ti; 1,5 mm; 15 cm	Diethrich micro forceps Ti 1.5 mm; 15 cm	509
114 91 0578	Diethrich pinzeta mikro Ti; 2,0 mm; 15 cm	Diethrich micro forceps Ti 2.0 mm; 15 cm	509
114 91 0579	Diethrich pinzeta mikro Ti; 2,8 mm; 15 cm	Diethrich micro forceps Ti 2.8 mm; 15 cm	509
114 91 0580	Diethrich pinzeta mikro Ti; 1,5 mm; 20 cm	Diethrich micro forceps Ti 1.5 mm; 20 cm	509
114 91 0581	Diethrich pinzeta mikro Ti; 2,0 mm; 20 cm	Diethrich micro forceps Ti 2.0 mm; 20 cm	509
114 91 0582	Diethrich pinzeta mikro Ti; 2,8 mm; 20 cm	Diethrich micro forceps Ti 2.8 mm; 20 cm	509
114 91 0583	Diethrich pinzeta mikro Ti; 1,5 mm; 24 cm	Diethrich micro forceps Ti 1.5 mm; 24 cm	509
114 91 0584	Diethrich pinzeta mikro Ti; 2,0 mm; 24 cm	Diethrich micro forceps Ti 2.0 mm; 24 cm	509
114 91 0585	Diethrich pinzeta mikro Ti; 2,8 mm; 24 cm	Diethrich micro forceps Ti 2.8 mm; 24 cm	509
115 08 0010	Mosquito-Halsted svorka na cévy rovná; 12,0 cm	Mosquito-Halsted artery forceps straight; 12.0 cm	102
115 08 0020	Mosquito-Halsted svorka na cévy zahnutá; 12,0 cm	Mosquito-Halsted artery forceps curved; 12.0 cm	102
115 08 0030	Mosquito-Halsted svorka rovná; 1x2 zuby; 12,0 cm	Mosquito-Halsted artery forceps; 1x2 teeth; 12.0 cm	102
115 08 0040	Mosquito-Halsted svorka rovná hladká; 1x2 zuby; 12,0 cm	Mosquito-Halsted artery forceps; 1x2 teeth; 12.0 cm	102
115 08 0050	Mosquito-Halsted svorka zahnutá; 1x2 zuby; 12,0 cm	Mosquito-Halsted artery forceps; 1x2 teeth; 12.0 cm	102
115 08 0060	Mosquito-Halsted svorka zahnutá hladká; 1x2 zuby; 12,0 cm	Mosquito-Halsted artery forceps; 1x2 teeth; 12.0 cm	102
115 08 0071	Pean svorka na cévy rovná; 17,5 cm	Pean artery forceps; 17.5 cm	104
115 08 0190	Pean svorka na cévy rovná jemná; 20,0 cm	Pean artery forceps straight; 20.0 cm	104
115 08 0200	Pean svorka na cévy zahnutá jemná; 20,0 cm	Pean artery forceps curved; 20.0 cm	104
115 08 0331	Kocher svorka na cévy rovná; 20,0 cm	Kocher artery forceps straight; 20.0 cm	105
115 08 0340	Kocher svorka na cévy rovná; 24,0 cm	Kocher artery forceps straight; 24.0 cm	105
115 08 0381	Kocher svorka na cévy zahnutá; 20,0 cm	Kocher artery forceps curved; 20.0 cm	105
115 08 0390	Kocher svorka na cévy zahnutá; 24,0 cm	Kocher artery forceps curved; 24.0 cm	105
115 08 0410	Kocher svorka na cévy rovná jemná; 20,0 cm	Kocher artery forceps straight fine; 20.0 cm	104
115 08 0420	Kocher svorka na cévy zahnutá jemná; 20,0 cm	Kocher artery forceps curved fine; 20.0 cm	104
115 08 0520	Kelly svorka na cévy zahnutá jemná; 22,5 cm	Kelly artery forceps curved fine; 22.5 cm	113
115 08 0550	Rochester-Ochsner svorka na cévy rovná; 14,0 cm	Rochester-Ochsner artery forceps straight; 14.0 cm	105
115 08 0561	Rochester-Ochsner svorka na cévy rovná; 16,0 cm	Rochester-Ochsner artery forceps straight; 16.0 cm	105
115 08 0590	Rochester-Ochsner svorka na cévy zahnutá; 14,0 cm	Rochester-Ochsner artery forceps curved; 14.0 cm	105
115 08 0601	Rochester-Ochsner svorka na cévy zahnutá; 16,0 cm	Rochester-Ochsner artery forceps curved; 16.0 cm	105
115 08 0780	Backhaus svorka s kuličkou; 11,0 cm	Backhaus forceps; 11.0 cm	168
115 08 0790	Backhaus svorka na papír; 12,0 cm	Backhaus paper forceps; 12.0 cm	168
115 08 0810	Backhaus svorka na prádlo; 9,0 cm	Backhaus towel forceps; 9.0 cm	169
115 08 0820	Backhaus svorka na prádlo; 13,0 cm	Backhaus towel forceps; 13.0 cm	169
115 08 1010	Mosquito-Halsted svorka na cévy rovná jemná; 12,0 cm	Mosquito-Halsted artery forceps straight; 12.0 cm	102
115 08 1020	Mosquito-Halsted svorka na cévy zahnutá jemná; 12,0 cm	Mosquito-Halsted artery forceps curved; 12.0 cm	102; 433
115 08 1030	Mosquito-Halsted svorka rovná jemná; 1x2 zuby; 12,0 cm	Mosquito-Halsted artery forceps straight; 1x2 teeth; 12.0 cm	102; 435
115 08 1050	Mosquito-Halsted svorka zahnutá jemná; 1x2 zuby; 12,0 cm	Mosquito-Halsted artery forceps curved; 1x2 teeth; 12.0 cm	102; 435
115 08 1090	Kocher svorka na cévy jemná rovná; 14,0 cm	Kocher artery forceps fine straight; 14.0 cm	107
115 08 1100	Kocher svorka na cévy jemná zahnutá; 14,0 cm	Kocher artery forceps fine curved; 14.0 cm	107
115 08 1110	Kocher svorka na cévy jemná rovná; 15,0 cm	Kocher artery forceps fine straight; 15.0 cm	107
115 08 1120	Kocher svorka na cévy jemná zahnutá; 15,0 cm	Kocher artery forceps fine curved; 15.0 cm	107
115 08 1130	Pean svorka na cévy jemná rovná; 16 cm	Pean artery forceps fine straight; 16 cm	107
115 08 1140	Pean svorka na cévy jemná zahnutá; 16 cm	Pean artery forceps fine curved; 16 cm	107
115 08 1150	Pean svorka na cévy jemná rovná; 20 cm	Pean artery forceps fine straight; 20 cm	107
115 08 1160	Pean svorka na cévy jemná zahnutá; 20 cm	Pean artery forceps fine curved; 20 cm	107
115 08 1170	Pean svorka na cévy jemná rovná; 14,5 cm	Pean artery forceps fine straight; 14.5 cm	107
115 08 1180	Pean svorka na cévy jemná zahnutá; 14,5 cm	Pean artery forceps fine curved; 14.5 cm	107
115 14 0010	Micro-bulldog svorka na cévy rovná; 2,5 cm	Micro-bulldog artery forceps straight; 2.5 cm	98
115 14 0020	Micro-bulldog svorka na cévy zahnutá; 2,5 cm	Micro-bulldog artery forceps curved; 2.5 cm	98
115 14 0150	Dieffenbach svorka na cévy rovná; 5,8 cm	Dieffenbach artery forceps straight; 5.8 cm	99
115 14 0160	Dieffenbach svorka na cévy zahnutá; 5,8 cm	Dieffenbach artery forceps curved; 5.8 cm	99
115 14 1150	Overholt svorka na lobektomii fig.1; 19,5 cm	Overholt lobectomy forceps fig.1; 19.5 cm	110
115 14 1160	Overholt svorka na lobektomii fig.2; 22,2 cm	Overholt lobectomy forceps fig.2; 22.2 cm	110
115 14 1170	Semb uvolňovač mírně zahnutý; 24,0 cm	Semb dissecting forceps curved; 24.0 cm	120
115 14 1180	Semb uvolňovač silně zahnutý; 24,0 cm	Semb dissecting forceps curved; 24.0 cm	120
115 14 1190	Semb uvolňovač silně zahnutý jemný; 24,0 cm	Semb dissecting forceps curved fine; 24.0 cm	120
115 14 1410	Svorka atraumatická fig.1; 21,5 cm	Artery forceps atraumatic jaws fig.1; 21.5 cm	134
115 14 1460	Svorka atraumatická fig.6; 21,0 cm	Artery forceps atraumatic jaws fig.6; 21.0 cm	134
115 14 1490	Svorka atraumatická fig.9; 24,0 cm	Artery forceps atraumatic jaws fig.9; 24.0 cm	134
115 14 1600	Sarot svorka na cévy zahnutá; 23,0 cm	Sarot artery forceps curved; 23.0 cm	115
115 27 0070	Mikulicz svorka na pobřišnici; 18,0 cm	Mikulicz peritoneal clamp-forceps; 18.0 cm	128
115 91 0031	Dieffenbach svorka na cévy rovná; 3,5 cm	Dieffenbach bulldog clamps straight; 3.5 cm	99
115 91 0032	Dieffenbach svorka na cévy rovná; 5,0 cm	Dieffenbach bulldog clamps straight; 5.0 cm	99
115 91 0034	Dieffenbach svorka na cévy zahnutá; 3,5 cm	Dieffenbach bulldog clamps curved; 3.5 cm	99
115 91 0035	Dieffenbach svorka na cévy zahnutá; 3,5 cm	Dieffenbach bulldog clamps curved; 3.5 cm	99
115 91 0037	Svorka pro svorky bulldog; 23,0 cm	Setting forceps for bulldog clamps; 23.0 cm	99
115 91 0039	Johns-Hopkins svorka na cévy rovná; 5,0 cm	Johns-Hopkins bulldog clamp straight; 5.0 cm	99
115 91 0040	Johns-Hopkins svorka na cévy rovná; 6,5 cm	Johns-Hopkins bulldog clamp straight; 6.5 cm	99
115 91 0041	Johns-Hopkins svorka na cévy rovná; 7,5 cm	Johns-Hopkins bulldog clamp straight; 7.5 cm	99
115 91 0042	Johns-Hopkins svorka na cévy rovná; 9,0 cm	Johns-Hopkins bulldog clamp straight; 9.0 cm	99
115 91 0044	Johns-Hopkins svorka na cévy zahnutá; 5,0 cm	Johns-Hopkins bulldog clamp curved; 5.0 cm	99
115 91 0045	Johns-Hopkins svorka na cévy zahnutá; 6,5 cm	Johns-Hopkins bulldog clamp curved; 6.5 cm	99
115 91 0046	Johns-Hopkins svorka na cévy zahnutá; 7,5 cm	Johns-Hopkins bulldog clamp curved; 7.5 cm	99
115 91 0047	Johns-Hopkins svorka na cévy zahnutá; 9,0 cm	Johns-Hopkins bulldog clamp curved; 9.0 cm	99

číslo – number	název	item	strana – page
115 91 0048	Chaput svorka na cévy; 3x2 zuby; 13,0 cm	Chaput artery forceps; 3x2 teeth; 13.0 cm	100
115 91 0049	Tuffier svorka na cévy; 5x4 zuby; 13,0 cm	Tuffier artery forceps; 5x4 teeth; 13.0 cm	100
115 91 0052	Pean svorka na cévy rovná; 14,0 cm	Pean artery forceps straight; 14.0 cm	101
115 91 0053	Pean svorka na cévy rovná; 16,0 cm	Pean artery forceps straight; 16.0 cm	101
115 91 0068	Hartmann svorka rovná; 10,0 cm	Hartmann forceps straight; 10.0 cm	103
115 91 0069	Hartmann svorka zahnutá; 10,0 cm	Hartmann forceps curved; 10.0 cm	103
115 91 0073	Micro-Mosquito svorka na cévy rovná; 12,0 cm	Micro-Mosquito artery forceps straight; 12.0 cm	103
115 91 0075	Micro-Mosquito svorka na cévy zahnutá; 12,0 cm	Micro-Mosquito artery forceps curved; 12.0 cm	103
115 91 0077	Micro-Mosquito svorka rovná 1x2 zuby; 12,0 cm	Micro-Mosquito artery forceps straight; 12.0 cm	103
115 91 0079	Micro-Mosquito svorka zahnutá 1x2 zuby; 12,0 cm	Micro-Mosquito artery forceps curved; 12.0 cm	103
115 91 0080	Halsted-Mosquito svorka na cévy rovná; 15,0 cm	Halsted-Mosquito artery forceps straight; 12.5 cm	103
115 91 0082	Halsted-Mosquito svorka na cévy zahnutá; 12,5 cm	Halsted-Mosquito artery forceps curved; 12.5 cm	103
115 91 0084	Halsted-Mosquito svorka; 1x2 zuby rovná; 12,5 cm	Halsted-Mosquito artery forceps straight; 1x2 teeth; 12.5 cm	103
115 91 0086	Halsted-Mosquito svorka zahnutá; 1x2 zuby; 12,5 cm	Halsted-Mosquito artery forceps curved; 1x2 teeth; 12.5 cm	103
115 91 0097	Leriche svorka na cévy rovná; 15,0 cm	Leriche artery forceps straight; 15.0 cm	104
115 91 0098	Leriche svorka na cévy zahnutá; 15,0 cm	Leriche artery forceps; 15.0 cm	104
115 91 0099	Leriche svorka na cévy rovná; 1x2 zuby; 15,0 cm	Leriche artery forceps straight; 1x2 teeth; 15.0 cm	104
115 91 0100	Leriche svorka na cévy zahnutá; 1x2 zuby; 15,0 cm	Leriche artery forceps curved; 1x2 teeth; 15.0 cm	104
115 91 0101	Providence-Hospital svorka na cévy rovná; 14,0 cm	Providence-Hospital artery forceps straight; 14.0 cm	104
115 91 0102	Providence-Hospital svorka na cévy zahnutá; 14,0 cm	Providence-Hospital artery forceps curved; 14.0 cm	104
115 91 0103	Kelly svorka na cévy rovná; 14,0 cm	Kelly artery forceps straight; 14.0 cm	106
115 91 0104	Kelly svorka na cévy zahnutá; 14,0 cm	Kelly artery forceps curved; 14.0 cm	106
115 91 0105	Kelly-Rankin svorka na cévy rovná; 16,0 cm	Kelly-Rankin artery forceps straight; 16.0 cm	106
115 91 0106	Kelly-Rankin svorka na cévy zahnutá; 16,0 cm	Kelly-Rankin artery forceps curved; 16.0 cm	106
115 91 0111	Crile svorka na cévy rovná; 14,0 cm	Crile artery forceps straight; 14.0 cm	106
115 91 0112	Crile svorka na cévy zahnutá; 14,0 cm	Crile artery forceps curved; 14.0 cm	106
115 91 0113	Crile svorka na cévy rovná; 1x2 zuby; 14,0 cm	Crile artery forceps straight; 1x2 teeth; 14.0 cm	106
115 91 0114	Crile svorka na cévy zahnutá; 1x2 zuby; 14,0 cm	Crile artery forceps curved; 1x2 teeth; 14.0 cm	106
115 91 0115	Crile-Rankin svorka na cévy rovná; 16,0 cm	Crile-Rankin artery forceps straight; 16.0 cm	106
115 91 0116	Crile-Rankin svorka na cévy zahnutá; 16,0 cm	Crile-Rankin artery forceps curved; 16.0 cm	106
115 91 0117	Rochester-Pean svorka na cévy rovná; 14,0 cm	Rochester-Pean artery forceps straight; 14.0 cm	108
115 91 0118	Rochester-Pean svorka na cévy rovná; 16,0 cm	Rochester-Pean artery forceps straight; 16.0 cm	108
115 91 0119	Rochester-Pean svorka na cévy rovná; 18,0 cm	Rochester-Pean artery forceps straight; 18.0 cm	108
115 91 0120	Rochester-Pean svorka na cévy rovná; 20,0 cm	Rochester-Pean artery forceps straight; 20.0 cm	108
115 91 0121	Rochester-Pean svorka na cévy rovná; 22,0 cm	Rochester-Pean artery forceps straight; 22.0 cm	108
115 91 0122	Rochester-Pean svorka na cévy rovná; 24,0 cm	Rochester-Pean artery forceps straight; 24.0 cm	108
115 91 0123	Rochester-Pean svorka na cévy rovná; 26,0 cm	Rochester-Pean artery forceps straight; 26.0 cm	108
115 91 0124	Rochester-Pean svorka na cévy rovná; 30,0 cm	Rochester-Pean artery forceps straight; 30.0 cm	108
115 91 0125	Rochester-Pean svorka na cévy zahnutá; 14,0 cm	Rochester-Pean artery forceps curved; 14.0 cm	108; 433; 435
115 91 0126	Rochester-Pean svorka na cévy zahnutá; 16,0 cm	Rochester-Pean artery forceps curved; 16.0 cm	108; 435
115 91 0127	Rochester-Pean svorka na cévy zahnutá; 18,0 cm	Rochester-Pean artery forceps curved; 18.0 cm	108
115 91 0128	Rochester-Pean svorka na cévy zahnutá; 20,0 cm	Rochester-Pean artery forceps curved; 20.0 cm	108; 432; 434; 435
115 91 0129	Rochester-Pean svorka na cévy zahnutá; 22,0 cm	Rochester-Pean artery forceps curved; 22.0 cm	108
115 91 0130	Rochester-Pean svorka na cévy zahnutá; 24,0 cm	Rochester-Pean artery forceps curved; 24.0 cm	108
115 91 0131	Rochester-Pean svorka na cévy zahnutá; 26,0 cm	Rochester-Pean artery forceps curved; 26.0 cm	108
115 91 0132	Rochester-Pean svorka na cévy zahnutá; 30,0 cm	Rochester-Pean artery forceps curved; 30.0 cm	108
115 91 0133	Ochsner-Kocher svorka na cévy rovná; 14,0 cm	Ochsner-Kocher artery forceps straight; 14.0 cm	109; 432; 434; 435
115 91 0134	Ochsner-Kocher svorka na cévy rovná; 16,0 cm	Ochsner-Kocher artery forceps straight; 16.0 cm	109
115 91 0135	Ochsner-Kocher svorka na cévy rovná; 18,0 cm	Ochsner-Kocher artery forceps straight; 18.0 cm	109
115 91 0136	Ochsner-Kocher svorka na cévy rovná; 20,0 cm	Ochsner-Kocher artery forceps straight; 20.0 cm	109
115 91 0137	Ochsner-Kocher svorka na cévy rovná; 22,0 cm	Ochsner-Kocher artery forceps straight; 22.0 cm	109
115 91 0138	Ochsner-Kocher svorka na cévy rovná; 24,0 cm	Ochsner-Kocher artery forceps straight; 24.0 cm	109
115 91 0139	Ochsner-Kocher svorka na cévy rovná; 26,0 cm	Ochsner-Kocher artery forceps straight; 26.0 cm	109
115 91 0140	Ochsner-Kocher svorka na cévy rovná; 30,0 cm	Ochsner-Kocher artery forceps straight; 30.0 cm	109
115 91 0141	Ochsner-Kocher svorka na cévy zahnutá; 14,0 cm	Ochsner-Kocher artery forceps curved; 14.0 cm	109
115 91 0142	Ochsner-Kocher svorka na cévy zahnutá; 16,0 cm	Ochsner-Kocher artery forceps curved; 16.0 cm	109
115 91 0143	Ochsner-Kocher svorka na cévy zahnutá; 18,0 cm	Ochsner-Kocher artery forceps curved; 18.0 cm	109
115 91 0144	Ochsner-Kocher svorka na cévy zahnutá; 20,0 cm	Ochsner-Kocher artery forceps curved; 20.0 cm	109
115 91 0145	Ochsner-Kocher svorka na cévy zahnutá; 22,0 cm	Ochsner-Kocher artery forceps curved; 22.0 cm	109
115 91 0146	Ochsner-Kocher svorka na cévy zahnutá; 24,0 cm	Ochsner-Kocher artery forceps curved; 24.0 cm	109
115 91 0147	Ochsner-Kocher svorka na cévy zahnutá; 26,0 cm	Ochsner-Kocher artery forceps curved; 26.0 cm	109
115 91 0148	Ochsner-Kocher svorka na cévy zahnutá; 30,0 cm	Ochsner-Kocher artery forceps curved; 30.0 cm	109
115 91 0149	Pean-Delicate svorka na cévy rovná; 13,0 cm	Pean-Delicate artery forceps straight; 13.0 cm	101
115 91 0150	Pean-Delicate svorka na cévy rovná; 14,0 cm	Pean-Delicate artery forceps straight; 14.0 cm	101
115 91 0151	Pean-Delicate svorka na cévy rovná; 16,0 cm	Pean-Delicate artery forceps straight; 16.0 cm	101
115 91 0152	Pean-Delicate svorka na cévy zahnutá; 13,0 cm	Pean-Delicate artery forceps curved; 13.0 cm	101
115 91 0153	Pean-Delicate svorka na cévy zahnutá; 14,0 cm	Pean-Delicate artery forceps curved; 14.0 cm	101
115 91 0154	Pean-Delicate svorka na cévy zahnutá; 16,0 cm	Pean-Delicate artery forceps curved; 16.0 cm	101
115 91 0155	Kocher-Delicate svorka na cévy rovná; 1x2 zuby; 13,0 cm	Kocher-Delicate artery forceps straight; 1x2 teeth; 13.0 cm	101
115 91 0156	Kocher-Delicate svorka na cévy rovná; 1x2 zuby; 14,0 cm	Kocher-Delicate artery forceps straight; 1x2 teeth; 14.0 cm	101
115 91 0157	Kocher-Delicate svorka na cévy rovná; 1x2 zuby; 16,0 cm	Kocher-Delicate artery forceps straight; 1x2 teeth; 16.0 cm	101
115 91 0158	Kocher-Delicate svorka na cévy zahnutá; 1x2 zuby; 13,0 cm	Kocher-Delicate artery forceps curved; 1x2 teeth; 13.0 cm	101
115 91 0159	Kocher-Delicate svorka na cévy zahnutá; 1x2 zuby; 14,0 cm	Kocher-Delicate artery forceps curved; 1x2 teeth; 14.0 cm	101
115 91 0160	Kocher-Delicate svorka na cévy zahnutá; 1x2 zuby; 16,0 cm	Kocher-Delicate artery forceps curved; 1x2 teeth; 16.0 cm	101
115 91 0161	Overholt-Geissendoerfer svorka na cévy fig.1	Overholt-Geissendoerfer forceps fig.1	110
115 91 0162	Overholt-Geissendoerfer svorka na cévy fig.2	Overholt-Geissendoerfer forceps fig.2	110
115 91 0163	Overholt-Geissendoerfer svorka na cévy fig.3	Overholt-Geissendoerfer forceps fig.3	110
115 91 0164	Overholt-Geissendoerfer svorka na cévy fig.4	Overholt-Geissendoerfer forceps fig.4	110
115 91 0165	Overholt-Geissendoerfer svorka na cévy fig.5	Overholt-Geissendoerfer forceps fig.5	110
115 91 0166	Overholt-Geissendoerfer svorka na cévy fig.6	Overholt-Geissendoerfer forceps fig.6	110
115 91 0167	Overholt-Geissendoerfer svorka na cévy fig.7	Overholt-Geissendoerfer forceps fig.7	110
115 91 0168	Overholt-Geissendoerfer svorka na cévy fig.1	Overholt-Geissendoerfer forceps fig.1	110
115 91 0169	Overholt-Geissendoerfer svorka na cévy fig.2	Overholt-Geissendoerfer forceps fig.2	110
115 91 0170	Overholt-Geissendoerfer svorka na cévy fig.3	Overholt-Geissendoerfer forceps fig.3	110



číslo – number	název	item	strana – page
115 91 0171	Overholt-Geissendoerfer svorka na cévy fig.4	Overholt-Geissendoerfer forceps fig.4	110
115 91 0172	Overholt-Geissendoerfer svorka na cévy fig.5	Overholt-Geissendoerfer forceps fig.5	110
115 91 0173	Overholt-Geissendoerfer svorka na cévy fig.6	Overholt-Geissendoerfer forceps fig.6	110
115 91 0174	Overholt-Geissendoerfer svorka na cévy fig.7	Overholt-Geissendoerfer forceps fig.7	110
115 91 0176	Overholt svorka na cévy s-prohnutá; 18,5 cm	Overholt artery forceps; 18.5 cm	111
115 91 0177	Overholt svorka na cévy s-prohnutá; 20,5 cm	Overholt artery forceps; 20.5 cm	111
115 91 0178	Overholt svorka na cévy s-prohnutá; 21,0 cm	Overholt artery forceps; 21.0 cm	111
115 91 0179	Overholt svorka na cévy s-prohnutá; 21,5 cm	Overholt artery forceps; 21.5 cm	111
115 91 0180	Baby-Adson svorka na cévy zahnutá; 14,0 cm	Baby-Adson artery forceps curved; 14.0 cm	112
115 91 0181	Baby-Adson svorka na cévy zahnutá; 18,0 cm	Baby-Adson artery forceps curved; 18.0 cm	112; 435
115 91 0182	Adson svorka na cévy rovná; 18,5 cm	Adson artery forceps straight; 18.5 cm	112
115 91 0183	Adson svorka na cévy zahnutá; 18,5 cm	Adson artery forceps curved; 18.5 cm	112
115 91 0184	Adson svorka na cévy rovná; 1x2 zuby; 18,5 cm	Adson artery forceps straight; 1x2 teeth; 18.5 cm	112
115 91 0185	Adson svorka na cévy zahnutá; 1x2 zuby; 18,5 cm	Adson artery forceps curved; 1x2 teeth; 18.5 cm	112
115 91 0186	Meeker svorka na cévy zahnutá; 18,0 cm	Meeker artery forceps curved; 18.0 cm	112
115 91 0187	Meeker svorka na cévy zahnutá; 28,0 cm	Meeker artery forceps curved; 28.0 cm	112
115 91 0190	Dandy svorka na cévy zahnutá; 14,0 cm	Dandy artery forceps curved; 14.0 cm	101
115 91 0191	Dandy svorka na cévy zahnutá; 1x2 zuby 14,0 cm	Dandy artery forceps curved; 1x2 teeth; 14.0 cm	101
115 91 0192	Schmidt-Sawtell svorka na cévy mírně zahnutá; 19,0 cm	Schmidt-Sawtell artery forceps curved; 19.0 cm	113
115 91 0193	Schmidt-Sawtell svorka na cévy silně zahnutá; 19,0 cm	Schmidt-Sawtell artery forceps curved; 19.0 cm	113
115 91 0196	Rochester-Carmal svorka na cévy rovná; 16,0 cm	Rochester-Carmalt artery forceps straight; 16.0 cm	113
115 91 0197	Rochester-Carmal svorka na cévy rovná; 20,0 cm	Rochester-Carmalt artery forceps straight; 20.0 cm	113
115 91 0198	Rochester-Carmal svorka na cévy zahnutá; 16,0 cm	Rochester-Carmalt artery forceps curved; 16.0 cm	113
115 91 0199	Rochester-Carmal svorka na cévy zahnutá; 20,0 cm	Rochester-Carmalt artery forceps curved; 20.0 cm	113
115 91 0200	Bainbridge svorka na cévy rovná; 15,0 cm	Bainbridge artery forceps straight; 15.0 cm	113
115 91 0201	Bainbridge svorka na cévy rovná; 18,5 cm	Bainbridge artery forceps straight; 18.5 cm	113
115 91 0202	Bainbridge svorka na cévy zahnutá; 15,0 cm	Bainbridge artery forceps curved; 15.0 cm	113
115 91 0203	Bainbridge svorka na cévy zahnutá; 18,5 cm	Bainbridge artery forceps curved; 18.5 cm	113
115 91 0204	Bengolea svorka na cévy rovná; 20,0 cm	Bengolea artery forceps straight; 20.0 cm	114
115 91 0205	Bengolea svorka na cévy rovná; 26,0 cm	Bengolea artery forceps straight; 26.0 cm	114
115 91 0206	Bengolea svorka na cévy zahnutá; 20,0 cm	Bengolea artery forceps curved; 20.0 cm	114
115 91 0207	Bengolea svorka na cévy zahnutá; 26,0 cm	Bengolea artery forceps curved; 26.0 cm	114
115 91 0208	Bengolea svorka na cévy rovná; 1x2 zuby; 20,0 cm	Bengolea artery forceps straight; 1x2 teeth; 20.0 cm	114
115 91 0209	Bengolea svorka na cévy rovná; 1x2 zuby; 26,0 cm	Bengolea artery forceps straight; 1x2 teeth; 26.0 cm	114
115 91 0210	Bengolea svorka na cévy zahnutá; 1x2 zuby; 20,0 cm	Bengolea artery forceps curved; 1x2 teeth; 20.0 cm	114
115 91 0211	Bengolea svorka na cévy zahnutá; 1x2 zuby; 26,0 cm	Bengolea artery forceps curved; 1x2 teeth; 26.0 cm	114
115 91 0212	Crafoord-Sellors svorka bronchiální; 22,0 cm	Crafoord-Sellors bronchus forceps; 22.0 cm	114
115 91 0213	Crafoord-Sellors svorka bronchiální; 23,0 cm	Crafoord-Sellors bronchus forceps; 23.0 cm	114
115 91 0214	Crafoord-Sellors svorka bronchiální; 24,0 cm	Crafoord-Sellors bronchus forceps; 24.0 cm	114
115 91 0215	Overholt-Mixter svorka na cévy zahnutá; 21,0 cm	Overholt-Mixter artery forceps curved; 21.0 cm	114
115 91 0216	Heiss svorka na cévy rovná fig.1; 20,0 cm	Heiss artery forceps straight fig.1; 20.0 cm	115
115 91 0217	Heiss svorka na cévy mírně zahnutá; 20,0 cm	Heiss artery forceps curved; 20.0 cm	115
115 91 0218	Heiss svorka na cévy silně zahnutá; 20,0 cm	Heiss artery forceps curved; 20.0 cm	115
115 91 0219	Roberts svorka na cévy rovná; 22,0 cm	Roberts artery forceps straight; 22.0 cm	115
115 91 0220	Roberts svorka na cévy zahnutá; 22,0 cm	Roberts artery forceps curved; 22.0 cm	115
115 91 0221	Sarot svorka na cévy rovná; 24,0 cm	Sarot artery forceps straight; 24.0 cm	115
115 91 0223	Crafoord svorka na cévy zahnutá; 24,0 cm	Crafoord artery forceps curved; 24.0 cm	115
115 91 0224	Rumel svorka preparační fig.1; 23,0 cm	Rumel dissecting forceps fig.1; 23.0 cm	116
115 91 0225	Rumel svorka preparační fig.2; 23,0 cm	Rumel dissecting forceps fig.2; 23.0 cm	116
115 91 0226	Rumel svorka preparační fig.3; 23,0 cm	Rumel dissecting forceps fig.3; 23.0 cm	116
115 91 0227	Rumel svorka preparační fig.4; 23,0 cm	Rumel dissecting forceps fig.4; 23.0 cm	116
115 91 0229	Zenker svorka preparační mírně zahnutá; 29,5 cm	Zenker dissecting forceps curved; 29.5 cm	116
115 91 0230	Zenker svorka preparační silně zahnutá; 29,5 cm	Zenker dissecting forceps curved; 29.5 cm	116
115 91 0231	Mixter svorka preparační zahnutá; 15,5 cm	Mixter dissecting forceps curved; 15.5 cm	117
115 91 0232	Mixter svorka preparační zahnutá; 19,0 cm	Mixter dissecting forceps curved; 19.0 cm	117
115 91 0233	Mixter-O'Shaugnessy svorka preparační zahnutá; 15,5 cm	Mixter-O'Shaugnessy dissecting forceps curved; 15.5 cm	117
115 91 0234	Mixter-O'Shaugnessy svorka preparační zahnutá; 19,0 cm	Mixter-O'Shaugnessy dissecting forceps curved; 19.0 cm	117
115 91 0235	Baby-Mixter svorka preparační zahnutá; 18,0 cm	Baby-Mixter dissecting forceps curved; 18.0 cm	117
115 91 0236	Baby-Mixter svorka preparační zahnutá; 14,0 cm	Baby-Mixter dissecting forceps curved; 14.0 cm	117
115 91 0237	Baby-Mixter svorka preparační zahnutá; 14,0 cm	Baby-Mixter dissecting forceps curved; 14.0 cm	117
115 91 0238	Mixter svorka preparační fig.1; 22,0 cm	Mixter dissecting forceps fig.1; 22.0 cm	117
115 91 0239	Mixter svorka preparační fig.2; 25,0 cm	Mixter dissecting forceps fig.2; 25.0 cm	117
115 91 0240	Mixter svorka preparační fig.3; 28,0 cm	Mixter dissecting forceps fig.3; 28.0 cm	117
115 91 0242	Bridge svorka preparační rovná; 28,0 cm	Bridge dissecting forceps straight; 28.0 cm	118
115 91 0243	Bridge svorka preparační zahnutá; 28,0 cm	Bridge dissecting forceps curved; 28.0 cm	118
115 91 0244	Lawrence svorka preparační zahnutá; 28,0 cm	Lawrence dissecting forceps curved; 28.0 cm	118
115 91 0245	Kantrowitz svorka preparační zahnutá; 20,0 cm	Kantrowitz dissecting and ligature forceps curved; 20.0 cm	119
115 91 0246	Kantrowitz svorka preparační zahnutá; 24,0 cm	Kantrowitz dissecting and ligature forceps curved; 24.0 cm	119
115 91 0247	Kantrowitz svorka preparační zahnutá; 28,0 cm	Kantrowitz dissecting and ligature forceps curved; 28.0 cm	119
115 91 0249	Gemini svorka preparační zahnutá; 18,0 cm	Gemini dissecting and ligature forceps curved; 18.0 cm	119
115 91 0251	Gemini svorka preparační zahnutá; 25,0 cm	Gemini dissecting and ligature forceps curved; 25.0 cm	119
115 91 0252	Gemini svorka preparační zahnutá; 28,0 cm	Gemini dissecting and ligature forceps curved; 28.0 cm	119
115 91 0253	Toennis svorka preparační rovná; 21,0 cm	Toennis dissecting forceps straight; 21.0 cm	119
115 91 0254	Toennis svorka preparační rovná; 26,0 cm	Toennis dissecting forceps straight; 26.0 cm	119
115 91 0255	Toennis svorka preparační zahnutá; 21,0 cm	Toennis dissecting forceps curved; 21.0 cm	119
115 91 0256	Toennis svorka preparační zahnutá; 26,0 cm	Toennis dissecting forceps curved; 26.0 cm	119
115 91 0257	Toennis svorka preparační rovná; 1x2 zuby; 21,0 cm	Toennis dissecting forceps straight; 1x2 teeth; 21.0 cm	119
115 91 0258	Toennis svorka preparační rovná; 1x2 zuby; 26,0 cm	Toennis dissecting forceps straight; 1x2 teeth; 26.0 cm	119
115 91 0259	Toennis svorka preparační zahnutá; 1x2 zuby; 21,0 cm	Toennis dissecting forceps curved; 1x2 teeth; 21.0 cm	119
115 91 0260	Toennis svorka preparační zahnutá; 1x2 zuby; 26,0 cm	Toennis dissecting forceps curved; 1x2 teeth; 26.0 cm	119
115 91 0261	Lahey svorka na žlučovod; 19,0 cm	Lahey gall duct clamp; 19.0 cm	122
115 91 0262	Lahey svorka na žlučovod; 23,0 cm	Lahey gall duct clamp; 23.0 cm	122
115 91 0263	Lower svorka na ledviny zahnutá; 18,0 cm	Lower kidney pedicle forceps curved; 18.0 cm	122
115 91 0264	Finochietto svorka na ledviny zahnutá; 24,0 cm	Finochietto kidney pedicle forceps; 24.0 cm	122

číslo – number	název	item	strana – page
115 91 0265	Guyon svorka na ledviny; 20,0 cm	Guyon kidney pedicle clamp-forceps; 20.0 cm	121
115 91 0266	Guyon svorka na ledviny; 22,0 cm	Guyon kidney pedicle clamp-forceps; 22.0 cm	121
115 91 0267	Guyon svorka na ledviny; 24,0 cm	Guyon kidney pedicle clamp-forceps; 24.0 cm	121
115 91 0268	Stille svorka na ledviny; 23,0 cm	Stille kidney pedicle clamp-forceps; 23.0 cm	121
115 91 0269	Guyon svorka na ledviny; 23,0 cm	Guyon kidney pedicle clamp-forceps; 23.0 cm	121
115 91 0270	Herrick svorka na ledviny; 23,0 cm	Herrick kidney pedicle clamp-forceps; 23.0 cm	121
115 91 0271	Gray svorka na žlučovod s-prohnutá; 22,0 cm	Gray gall duct clamp; 22.0 cm	123
115 91 0272	Gray svorka na žlučovod s-prohnutá; 23,0 cm	Gray gall duct clamp; 23.0 cm	123
115 91 0273	Gray svorka na žlučovod s-prohnutá; 1×2 zuby; 22,0 cm	Gray gall duct clamp; 1×2 teeth; 22.0 cm	123
115 91 0274	Gray svorka na žlučovod s-prohnutá; 1×2 zuby; 23,0 cm	Gray gall duct clamp; 1×2 teeth; 23.0 cm	123
115 91 0275	Desjardins svorka na žlučovod; 21,0 cm	Desjardins gall duct clamp; 21.0 cm	123
115 91 0276	Negus svorka na žlučovod fig.1; 19,0 cm	Negus gall duct clamp fig.1; 19.0 cm	123
115 91 0277	Negus svorka na žlučovod fig.2; 19,0 cm	Negus gall duct clamp fig.2; 19.0 cm	123
115 91 0281	Wertheim svorka na hysterektomii; 27,0 cm	Wertheim hysterectomy clamp-forceps; 27.0 cm	124; 445
115 91 0282	Wertheim svorka na hysterektomii extra silná; 24,0 cm	Wertheim hysterectomy clamp-forceps; 24.0 cm	124; 445
115 91 0283	Wertheim svorka na hysterektomii; 25,0 cm	Wertheim hysterectomy clamp-forceps; 25.0 cm	124; 445
115 91 0284	Wertheim svorka na hysterektomii mírně zah.; 1×2 zuby; 23,0 cm	Wertheim hysterectomy clamp-forceps; 1×2 teeth; 23.0 cm	125; 446
115 91 0285	Wertheim svorka na hysterektomii silně zah.; 1×2 zuby; 23,0 cm	Wertheim hysterectomy clamp-forceps; 1×2 teeth; 23.0 cm	125; 446
115 91 0286	Heaney svorka na hysterektomii; 21,0 cm	Heaney hysterectomy clamp-forceps; 21.0 cm	125; 446
115 91 0287	Heaney svorka na hysterektomii; 1 zub; 21,0 cm	Heaney hysterectomy clamp-forceps; 1 tooth; 21.0 cm	125; 446
115 91 0288	Heaney svorka na hysterektomii; 1 zub; 23,0 cm	Heaney hysterectomy clamp-forceps; 1 tooth; 23.0 cm	125; 446
115 91 0289	Heaney svorka na hysterektomii; 2 zuby; 21,0 cm	Heaney hysterectomy clamp-forceps; 2 teeth; 21.0 cm	125; 446
115 91 0290	Heaney svorka na hysterektomii; 2 zuby; 23,0 cm	Heaney hysterectomy clamp-forceps; 2 teeth; 23.0 cm	125; 446
115 91 0291	Heaney-Ballantine svorka na hysterektomii rovná; 21,0 cm	Heaney-Ballantine clamp-forceps straight; 21.0 cm	126; 447
115 91 0292	Heaney-Ballantine svorka na hysterektomii zahnutá; 21,0 cm	Heaney-Ballantine clamp-forceps curved; 21.0 cm	126; 447
115 91 0299	Wertheim-Cullen svorka na hysterektomii; 21,5 cm	Wertheim-Cullen clamp-forceps; 21.5 cm	126; 447
115 91 0300	Phaneuf svorka na hysterektomii rovná; 1×2 zuby; 21,5 cm	Phaneuf hysterectomy forceps straight; 1×2 teeth; 21.5 cm	126; 447
115 91 0301	Phaneuf svorka na hysterektomii zahnutá; 1×2 zuby; 21,5 cm	Phaneuf hysterectomy forceps curved; 1×2 teeth; 21.5 cm	126; 447
115 91 0305	Parametrium svorka rovná; 21,0 cm	Parametrium clamp straight; 21.0 cm	129
115 91 0306	Parametrium svorka zahnutá fig.1; 21,0 cm	Parametrium clamp curved fig.1; 21.0 cm	129
115 91 0307	Parametrium svorka zahnutá fig.2; 21,0 cm	Parametrium clamp curved fig.2; 21.0 cm	129
115 91 0308	Parametrium svorka zahnutá fig.3; 21,0 cm	Parametrium clamp curved fig.3; 21.0 cm	129
115 91 0309	Parametrium svorka rovná; 24,0 cm	Parametrium clamp straight; 24.0 cm	129
115 91 0310	Parametrium svorka zahnutá fig.1; 24,0 cm	Parametrium clamp curved fig.1; 24.0 cm	129
115 91 0311	Parametrium svorka zahnutá fig.2; 24,0 cm	Parametrium clamp curved fig.2; 24.0 cm	129
115 91 0312	Parametrium svorka zahnutá fig.3; 24,0 cm	Parametrium clamp curved fig.3; 24.0 cm	129
115 91 0313	Fergusson svorka rovná; 16,0 cm	Fergusson angiotribe clamp straight; 16.0 cm	130
115 91 0314	Fergusson svorka rovná; 20,0 cm	Fergusson angiotribe clamp straight; 20.0 cm	130
115 91 0315	Fergusson svorka zahnutá; 16,0 cm	Fergusson angiotribe clamp curved; 16.0 cm	130
115 91 0316	Fergusson svorka zahnutá; 20,0 cm	Fergusson angiotribe clamp curved; 20.0 cm	130
115 91 0317	Pratt svorka na hemeroidy; 15,0 cm	Pratt haemorrhoidal forceps; 15.0 cm	130
115 91 0322	Baby-Mikulicz svorka na pobřišnici; 14,0 cm	Baby-Mikulicz peritoneal clamp-forceps; 14.0 cm	128
115 91 0326	Mikulicz svorka na pobřišnici; 1×2 zuby; 20,0 cm	Mikulicz peritoneal clamp-forceps; 1×2 teeth; 20.0 cm	128
115 91 0329	Faure svorka na pobřišnici; 1×2 zuby; 20,0 cm	Faure peritoneal clamp-forceps; 1×2 teeth; 20.0 cm	128
115 91 0330	Faure svorka na pobřišnici; 1×2 zuby; 20,0 cm	Faure peritoneal clamp-forceps; 1×2 teeth; 20.0 cm	128
115 91 0332	Schaedel svorka na prádlo; 9,0 cm	Schaedel towel forceps; 9.0 cm	168
115 91 0333	Jones svorka na prádlo; 5,0 cm	Jones towel forceps; 5.0 cm	168
115 91 0334	Jones svorka na prádlo; 9,0 cm	Jones towel forceps; 9.0 cm	168
115 91 0335	Engl. Modell svorka na prádlo; 9,0 cm	Engl. Modell towel forceps; 9.0 cm	168
115 91 0336	Doyen svorka na prádlo; 18,0 cm	Doyen towel forceps; 18.0 cm	168
115 91 0337	Bernhard svorka na prádlo; 16,5 cm	Bernhard towel forceps; 16.5 cm	168
115 91 0338	Lane svorka na prádlo; 15,0 cm	Lane towel forceps; 15.0 cm	168
115 91 0339	Lane svorka na prádlo; 18,0 cm	Lane towel forceps; 18.0 cm	168
115 91 0340	Lane svorka na prádlo; 20,0 cm	Lane towel forceps; 20.0 cm	168
115 91 0341	Backhaus-Clip svorka na prádlo; 11,0 cm	Backhaus-Clip towel forceps; 11.0 cm	169
115 91 0343	Backhaus svorka na prádlo; 11,0 cm	Backhaus towel forceps; 11.0 cm	169; 432; 434
115 91 0345	Backhaus svorka na prádlo; 11,0 cm	Backhaus towel forceps; 11.0 cm	169
115 91 0348	Roeder svorka na prádlo; 13,0 cm	Roeder towel forceps; 13.0 cm	169
115 91 0349	Roeder svorka na prádlo; 15,0 cm	Roeder towel forceps; 15.0 cm	169
115 91 0350	Lorna svorka na prádlo; 10,0 cm	Lorna towel forceps; 10.0 cm	169
115 91 0351	Lorna svorka na prádlo; 13,0 cm	Lorna towel forceps; 13.0 cm	169
115 91 0352	Tohoku-Japan svorka na prádlo; 10,0 cm	Tohoku-Japan towel forceps; 10.0 cm	169
115 91 0353	Tohoku-Japan svorka na prádlo; 13,0 cm	Tohoku-Japan towel forceps; 13.0 cm	169
115 91 0354	Peers svorka na prádlo; 14,5 cm	Peers towel forceps; 14.5 cm	169
115 91 0355	Presbyterian svorka na trubice; 16,5 cm	Presbyterian tubing clamp; 16.5 cm	170
115 91 0356	Presbyterian svorka na trubice; 18,0 cm	Presbyterian tubing clamp; 18.0 cm	170
115 91 0357	Klinikum Berlin svorka na trubice; 14,5 cm	Klinikum Berlin tubing clamp; 14.5 cm	170
115 91 0358	Svorka na trubice; 15,5 cm	Tubing clamp; 15.5 cm	170
115 91 0359	Svorka na trubice; 18,0 cm	Tubing clamp; 18.0 cm	170
115 91 0360	Svorka na trubice; 20,0 cm	Tubing clamp; 20.0 cm	170
115 91 0361	Svorka na trubice s klipem; 15,5 cm	Tubing clamp with clip; 15.5 cm	170
115 91 0362	Svorka na trubice s klipem; 18,0 cm	Tubing clamp with clip; 18.0 cm	170
115 91 0363	Svorka na trubice s klipem; 20,0 cm	Tubing clamp with clip; 20.0 cm	170
115 91 0364	Allis svorka chirurgická; 4×5 zubů; 15,0 cm	Allis tissue forceps; 4×5 teeth; 15.0 cm	100
115 91 0365	Allis svorka chirurgická; 5×6 zubů; 15,0 cm	Allis tissue forceps; 5×6 teeth; 15.0 cm	100
115 91 0366	Allis svorka chirurgická; 5×6 zubů; 19,0 cm	Allis tissue forceps; 5×6 teeth; 19.0 cm	100
115 91 0367	Allis svorka chirurgická; 5×6 zubů; 25,0 cm	Allis tissue forceps; 5×6 teeth; 25.0 cm	100
115 91 0382	Babcock svorka chirurgická; 16,0 cm	Babcock tissue seizing forceps; 16.0 cm	98
115 91 0384	Babcock svorka chirurgická; 18,0 cm	Babcock tissue seizing forceps; 18.0 cm	98
115 91 0385	Babcock svorka chirurgická; 20,0 cm	Babcock tissue seizing forceps; 20.0 cm	98
115 91 0386	Babcock svorka chirurgická; 24,0 cm	Babcock tissue seizing forceps; 24.0 cm	98
115 91 0403	Mayo-Robson svorka na střeva přímá; 21,0 cm	Mayo-Robson intestinal forceps straight; 21.0 cm	127
115 91 0404	Mayo-Robson svorka na střeva přímá; 23,0 cm	Mayo-Robson intestinal forceps straight; 23.0 cm	127
115 91 0405	Mayo-Robson svorka na střeva přímá; 25,0 cm	Mayo-Robson intestinal forceps straight; 25.0 cm	127

číslo – number	název	item	strana – page
115 91 0406	Mayo-Robson svorka na střeva zahnutá; 21,0 cm	Mayo-Robson intestinal forceps curved; 21.0 cm	127
115 91 0407	Mayo-Robson svorka na střeva zahnutá; 23,0 cm	Mayo-Robson intestinal forceps curved; 23.0 cm	127
115 91 0408	Mayo-Robson svorka na střeva zahnutá; 25,0 cm	Mayo-Robson intestinal forceps curved; 25.0 cm	127
115 91 0488	Satinsky svorka atraumatická; 24,0 cm	Satinsky atrauma forceps; 24.0 cm	144
115 91 0489	Leland-Jones svorka atraumatická; 20,0 cm	Leland-Jones atrauma forceps; 20.0 cm	138
115 91 0490	De Bakey svorka atraumatická; 20,0 cm	De Bakey atrauma forceps; 20.0 cm	137
115 91 0492	Satinsky svorka atraumatická; 20,5 cm	Satinsky atrauma forceps; 20.5 cm	144
115 91 0578	O-kroužek gumový k aplikátoru (bal.=100 ks)	Gum O-ring for applicator (100 pcs)	349
115 91 0579	Aplikátor sací na hemoroidy	Suction haemorrhoidal ligator 10 mm complete	349
115 91 0591	De Bakey-Pean svorka atraumatická; 14,0 cm	De Bakey-Pean atrauma forceps; 14.0 cm	135
115 91 0592	De Bakey-Pean svorka atraumatická; 14,0 cm	De Bakey-Pean atrauma forceps; 14.0 cm	135
115 91 0594	Cooley svorka atraumatická; 14,0 cm	Cooley atrauma forceps; 14.0 cm	161
115 91 0595	Cooley svorka atraumatická; 14,0 cm	Cooley atrauma forceps; 14.0 cm	161
115 91 0596	De Bakey-Mosquito svorka atraumatická; 12,0 cm	De Bakey-Mosquito atrauma forceps; 12.0 cm	135
115 91 0597	De Bakey-Pean svorka atraumatická; 20,0 cm	De Bakey-Pean atrauma forceps; 20.0 cm	135
115 91 0598	De Bakey svorka atraumatická; 21,0 cm	De Bakey atrauma forceps; 21.0 cm	143
115 91 0599	Lees svorka atraumatická; 23,0 cm	Lees atrauma forceps; 23.0 cm	148
115 91 0600	De Bakey bulldog svorka atraumatická rovná; 7,5 cm	De Bakey atrauma bulldog clamp straight; 7.5 cm	131
115 91 0601	De Bakey bulldog svorka atraumatická rovná; 8,5 cm	De Bakey atrauma bulldog clamp straight; 8.5 cm	131
115 91 0602	De Bakey bulldog svorka atraumatická rovná; 10,5 cm	De Bakey atrauma bulldog clamp straight; 10.5 cm	131
115 91 0603	De Bakey bulldog svorka atraumatická rovná; 12,0 cm	De Bakey atrauma bulldog clamp straight; 12.0 cm	131
115 91 0604	De Bakey bulldog svorka atraumatická zahnutá; 7,0 cm	De Bakey atrauma bulldog clamp curved; 7.0 cm	131
115 91 0605	De Bakey bulldog svorka atraumatická zahnutá; 8,0 cm	De Bakey atrauma bulldog clamp curved; 8.0 cm	131
115 91 0606	De Bakey bulldog svorka atraumatická zahnutá; 10,0 cm	De Bakey atrauma bulldog clamp curved; 10.0 cm	131
115 91 0607	De Bakey bulldog svorka atraumatická zahnutá; 11,5 cm	De Bakey atrauma bulldog clamp curved; 11.5 cm	131
115 91 0608	Santulli bulldog svorka atraumatická; 7,0 cm	Santulli atrauma bulldog clamp; 7.0 cm	131
115 91 0609	Glover svorka atraumatická rovná; 6,0 cm	Glover atrauma clamp straight; 6.0 cm	132
115 91 0610	Glover svorka atraumatická rovná; 7,0 cm	Glover atrauma clamp straight; 7.0 cm	132
115 91 0611	Glover svorka atraumatická rovná; 9,0 cm	Glover atrauma clamp straight; 9.0 cm	132
115 91 0612	Glover svorka atraumatická rovná; 11,0 cm	Glover atrauma clamp straight; 11.0 cm	132
115 91 0613	Glover svorka atraumatická zahnutá; 5,5 cm	Glover atrauma clamp curved; 5.5 cm	132
115 91 0614	Glover svorka atraumatická zahnutá; 6,5 cm	Glover atrauma clamp curved; 6.5 cm	132
115 91 0615	Glover svorka atraumatická zahnutá; 8,5 cm	Glover atrauma clamp curved; 8.5 cm	132
115 91 0616	Glover svorka atraumatická zahnutá; 10,5 cm	Glover atrauma clamp curved; 10.5 cm	132
115 91 0617	Glover svorka atraumatická; 5,0 cm	Glover atrauma clamp; 5.0 cm	132
115 91 0618	De Bakey-Satinsky bulldog svorka; 7,0 cm	De Bakey-Satinsky bulldog clamp; 7.0 cm	133
115 91 0619	De Bakey-Carotis bulldog svorka; 9,0 cm	De Bakey-Carotis bulldog clamp; 9.0 cm	133
115 91 0620	De Bakey-Satinsky bulldog svorka; 10,0 cm	De Bakey-Satinsky bulldog clamp; 10.0 cm	133
115 91 0621	Gregory-Soft bulldog svorka; 9,0 cm	Gregory-Soft bulldog clamp; 9.0 cm	133
115 91 0622	Gregory-Soft bulldog svorka; 11,0 cm	Gregory-Soft bulldog clamp; 11.0 cm	133
115 91 0623	Gregory-Soft bulldog svorka; 11,0 cm	Gregory-Soft bulldog clamp; 11.0 cm	133
115 91 0624	Gregory-Soft bulldog svorka; 11,0 cm	Gregory-Soft bulldog clamp; 11.0 cm	133
115 91 0625	De Bakey-Rankin svorka atraumatická; 16,0 cm	De Bakey-Rankin atrauma forceps; 16.0 cm	135
115 91 0626	De Bakey-Rankin svorka atraumatická; 16,0 cm	De Bakey-Rankin atrauma forceps; 16.0 cm	135
115 91 0627	De Bakey-Mosquito svorka atraumatická; 15,0 cm	De Bakey-Mosquito atrauma forceps; 15.0 cm	135
115 91 0628	De Bakey-Mosquito svorka atraumatická; 15,0 cm	De Bakey-Mosquito atrauma forceps; 15.0 cm	135
115 91 0629	De Bakey-Mosquito svorka atraumatická; 12,0 cm	De Bakey-Mosquito atrauma forceps; 12.0 cm	135
115 91 0630	De Bakey-Pean svorka atraumatická; 16,0 cm	De Bakey-Pean atrauma forceps; 16.0 cm	135
115 91 0631	De Bakey-Pean svorka atraumatická; 18,0 cm	De Bakey-Pean atrauma forceps; 18.0 cm	135
115 91 0632	De Bakey-Pean svorka atraumatická; 16,0 cm	De Bakey-Pean atrauma forceps; 16.0 cm	135
115 91 0633	De Bakey-Pean svorka atraumatická; 18,0 cm	De Bakey-Pean atrauma forceps; 18.0 cm	135
115 91 0634	De Bakey-Pean svorka atraumatická; 20,0 cm	De Bakey-Pean atrauma forceps; 20.0 cm	135
115 91 0635	Potts svorka atraumatická; 21,0 cm	Potts atrauma forceps; 21.0 cm	136
115 91 0636	Potts svorka atraumatická; 22,0 cm	Potts atrauma forceps; 22.0 cm	136
115 91 0637	Potts svorka atraumatická; 22,0 cm	Potts atrauma forceps; 22.0 cm	136
115 91 0638	Potts svorka atraumatická; 22,0 cm	Potts atrauma forceps; 22.0 cm	136
115 91 0639	Potts svorka atraumatická; 21,0 cm	Potts atrauma forceps; 21.0 cm	136
115 91 0640	Potts svorka atraumatická; 22,0 cm	Potts atrauma forceps; 22.0 cm	136
115 91 0641	Potts svorka atraumatická; 22,0 cm	Potts atrauma forceps; 22.0 cm	136
115 91 0642	Potts svorka atraumatická; 22,0 cm	Potts atrauma forceps; 22.0 cm	136
115 91 0643	De Bakey svorka atraumatická; 19,0 cm	De Bakey atrauma forceps; 19.0 cm	137
115 91 0644	De Bakey svorka atraumatická; 23,0 cm	De Bakey atrauma forceps; 23.0 cm	137
115 91 0645	De Bakey svorka atraumatická; 16,0 cm	De Bakey atrauma forceps; 16.0 cm	137
115 91 0646	De Bakey svorka atraumatická; 19,0 cm	De Bakey atrauma forceps; 19.0 cm	137
115 91 0647	De Bakey svorka atraumatická; 20,0 cm	De Bakey atrauma forceps; 20.0 cm	137
115 91 0648	Leland-Jones svorka atraumatická; 18,0 cm	Leland-Jones atrauma forceps; 18.0 cm	138
115 91 0649	Leland-Jones svorka atraumatická; 19,0 cm	Leland-Jones atrauma forceps; 19.0 cm	138
115 91 0650	Bainbridge svorka atraumatická; 15,0 cm	Bainbridge atrauma forceps; 15.0 cm	138
115 91 0651	Bainbridge svorka atraumatická; 18,0 cm	Bainbridge atrauma forceps; 18.0 cm	138
115 91 0652	Bainbridge svorka atraumatická; 15,0 cm	Bainbridge atrauma forceps; 15.0 cm	138
115 91 0653	Bainbridge svorka atraumatická; 18,0 cm	Bainbridge atrauma forceps; 18.0 cm	138
115 91 0654	De Bakey svorka atraumatická; 26,0 cm	De Bakey atrauma forceps; 26.0 cm	139
115 91 0655	De Bakey svorka atraumatická; 27,0 cm	De Bakey atrauma forceps; 27.0 cm	139
115 91 0656	De Bakey svorka atraumatická; 31,0 cm	De Bakey atrauma forceps; 31.0 cm	139
115 91 0657	De Bakey svorka atraumatická; 33,0 cm	De Bakey atrauma forceps; 33.0 cm	139
115 91 0658	De Bakey svorka atraumatická; 25,0 cm	De Bakey atrauma forceps; 25.0 cm	140
115 91 0659	De Bakey svorka atraumatická; 26,0 cm	De Bakey atrauma forceps; 26.0 cm	140
115 91 0660	De Bakey svorka atraumatická; 24,0 cm	De Bakey atrauma forceps; 24.0 cm	140
115 91 0661	De Bakey svorka atraumatická; 24,0 cm	De Bakey atrauma forceps; 24.0 cm	140
115 91 0662	De Bakey svorka atraumatická; 30,0 cm	De Bakey atrauma forceps; 30.0 cm	141
115 91 0663	De Bakey svorka atraumatická; 28,0 cm	De Bakey atrauma forceps; 28.0 cm	141
115 91 0664	De Bakey svorka atraumatická; 21,0 cm	De Bakey atrauma forceps; 21.0 cm	142
115 91 0665	De Bakey svorka atraumatická; 23,0 cm	De Bakey atrauma forceps; 23.0 cm	142
115 91 0666	De Bakey svorka atraumatická; 27,0 cm	De Bakey atrauma forceps; 27.0 cm	142



číslo – number	název	item	strana – page
115 91 0667	De Bakey svorka atraumatická; 31,0 cm	De Bakey atrauma forceps; 31.0 cm	142
115 91 0668	De Bakey svorka atraumatická; 18,0 cm	De Bakey atrauma forceps; 18.0 cm	142
115 91 0669	De Bakey svorka atraumatická; 19,0 cm	De Bakey atrauma forceps; 19.0 cm	142
115 91 0670	De Bakey svorka atraumatická; 23,0 cm	De Bakey atrauma forceps; 23.0 cm	142
115 91 0671	De Bakey svorka atraumatická; 27,0 cm	De Bakey atrauma forceps; 27.0 cm	142
115 91 0672	De Bakey svorka atraumatická; 20,0 cm	De Bakey atrauma forceps; 20.0 cm	143
115 91 0673	De Bakey svorka atraumatická; 25,0 cm	De Bakey atrauma forceps; 25.0 cm	143
115 91 0674	De Bakey svorka atraumatická; 29,0 cm	De Bakey atrauma forceps; 29.0 cm	143
115 91 0675	De Bakey svorka atraumatická; 21,0 cm	De Bakey atrauma forceps; 21.0 cm	143
115 91 0676	De Bakey svorka atraumatická; 23,0 cm	De Bakey atrauma forceps; 23.0 cm	143
115 91 0677	De Bakey svorka atraumatická; 27,0 cm	De Bakey atrauma forceps; 27.0 cm	143
115 91 0678	De Bakey svorka atraumatická; 31,0 cm	De Bakey atrauma forceps; 31.0 cm	143
115 91 0679	Satinsky svorka atraumatická; 25,0 cm	Satinsky atrauma forceps; 25.0 cm	144
115 91 0680	Satinsky svorka atraumatická; 26,0 cm	Satinsky atrauma forceps; 26.0 cm	144
115 91 0681	Satinsky svorka atraumatická; 27,5 cm	Satinsky atrauma forceps; 27.5 cm	144
115 91 0682	Lambert-Kay svorka atraumatická; 21,0 cm	Lambert-Kay atrauma forceps; 21.0 cm	145
115 91 0683	Lambert-Kay svorka atraumatická; 21,0 cm	Lambert-Kay atrauma forceps; 21.0 cm	145
115 91 0684	De Bakey svorka atraumatická; 17,0 cm	De Bakey atrauma forceps; 17.0 cm	145
115 91 0685	De Bakey-Bahnsen svorka atraumatická; 23,0 cm	De Bakey-Bahnsen atrauma forceps; 23.0 cm	145
115 91 0686	De Bakey-Bahnsen svorka atraumatická; 24,0 cm	De Bakey-Bahnsen atrauma forceps; 24.0 cm	145
115 91 0687	De Bakey-Bahnsen svorka atraumatická; 25,0 cm	De Bakey-Bahnsen atrauma forceps; 25.0 cm	145
115 91 0688	Harken svorka atraumatická; 24,0 cm	Harken atrauma forceps; 24.0 cm	146
115 91 0689	Harken svorka atraumatická; 24,0 cm	Harken atrauma forceps; 24.0 cm	146
115 91 0690	Harken svorka atraumatická; 24,0 cm	Harken atrauma forceps; 24.0 cm	146
115 91 0691	Harken svorka atraumatická; 24,0 cm	Harken atrauma forceps; 24.0 cm	146
115 91 0692	Weber svorka atraumatická; 26,0 cm	Weber atrauma forceps; 26.0 cm	147
115 91 0693	Weber svorka atraumatická; 26,0 cm	Weber atrauma forceps; 26.0 cm	147
115 91 0694	Lees svorka atraumatická; 25,0 cm	Lees atrauma forceps; 25.0 cm	148
115 91 0695	Lees svorka atraumatická; 25,0 cm	Lees atrauma forceps; 25.0 cm	148
115 91 0696	De Bakey svorka atraumatická; 27,0 cm	De Bakey atrauma forceps; 27.0 cm	149
115 91 0697	Morris-De Bakey svorka atraumatická; 18,0 cm	Morris-De Bakey atrauma forceps; 18.0 cm	150
115 91 0698	Morris-De Bakey svorka atraumatická; 20,0 cm	Morris-De Bakey atrauma forceps; 20.0 cm	150
115 91 0699	Morris-De Bakey svorka atraumatická; 23,0 cm	Morris-De Bakey atrauma forceps; 23.0 cm	150
115 91 0700	Morris-De Bakey svorka atraumatická; 25,0 cm	Morris-De Bakey atrauma forceps; 25.0 cm	150
115 91 0701	Ochsner svorka atraumatická; 23,5 cm	Ochsner atrauma forceps; 23.5 cm	151
115 91 0702	Dietrich svorka atraumatická; 21,0 cm	Dietrich atrauma forceps; 21.0 cm	151
115 91 0703	Gregory svorka atraumatická; 14,0 cm	Gregory atrauma forceps; 14.0 cm	151
115 91 0704	Gregory svorka atraumatická; 16,0 cm	Gregory atrauma forceps; 16.0 cm	151
115 91 0705	Gregory svorka atraumatická; 18,0 cm	Gregory atrauma forceps; 18.0 cm	151
115 91 0706	Dale svorka atraumatická; 17,0 cm	Dale atrauma forceps; 17.0 cm	152
115 91 0707	Dale svorka atraumatická; 18,0 cm	Dale atrauma forceps; 18.0 cm	152
115 91 0708	Dale svorka atraumatická; 19,0 cm	Dale atrauma forceps; 19.0 cm	152
115 91 0709	Dale svorka atraumatická; 18,5 cm	Dale atrauma forceps; 18.5 cm	152
115 91 0710	Derra svorka atraumatická; 16,0 cm	Derra atrauma forceps; 16.0 cm	152
115 91 0711	Derra svorka atraumatická; 17,0 cm	Derra atrauma forceps; 17.0 cm	152
115 91 0712	Derra svorka atraumatická; 18,0 cm	Derra atrauma forceps; 18.0 cm	152
115 91 0713	Svorka atraumatická; 16,0 cm	Atrauma forceps; 16.0 cm	153
115 91 0714	Svorka atraumatická; 17,0 cm	Atrauma forceps; 17.0 cm	153
115 91 0715	Beck svorka atraumatická; 17,0 cm	Beck atrauma forceps; 17.0 cm	153
115 91 0716	Glover svorka atraumatická; 17,0 cm	Glover atrauma forceps; 17.0 cm	153
115 91 0717	Glover svorka atraumatická; 17,0 cm	Glover atrauma forceps; 17.0 cm	153
115 91 0718	De Bakey svorka atraumatická; 17,0 cm	De Bakey atrauma forceps; 17.0 cm	154
115 91 0719	De Bakey svorka atraumatická; 17,0 cm	De Bakey atrauma forceps; 17.0 cm	154
115 91 0720	De Bakey svorka atraumatická; 15,0 cm	De Bakey atrauma forceps; 15.0 cm	154
115 91 0721	De Bakey svorka atraumatická; 15,0 cm	De Bakey atrauma forceps; 15.0 cm	154
115 91 0722	De Bakey svorka atraumatická; 16,0 cm	De Bakey atrauma forceps; 16.0 cm	154
115 91 0723	Javid svorka atraumatická; 18,0 cm	Javid atrauma forceps; 18.0 cm	155
115 91 0724	Javid svorka atraumatická; 19,0 cm	Javid atrauma forceps; 19.0 cm	155
115 91 0725	Cooley svorka atraumatická; 16,0 cm	Cooley atrauma forceps; 16.0 cm	155
115 91 0726	Cooley svorka atraumatická; 16,0 cm	Cooley atrauma forceps; 16.0 cm	155
115 91 0727	Cooley svorka atraumatická; 20,0 cm	Cooley atrauma forceps; 20.0 cm	155
115 91 0728	Cooley svorka atraumatická; 20,0 cm	Cooley atrauma forceps; 20.0 cm	155
115 91 0729	Cooley svorka atraumatická; 20,0 cm	Cooley atrauma forceps; 20.0 cm	155
115 91 0730	Cooley svorka atraumatická; 20,0 cm	Cooley atrauma forceps; 20.0 cm	155
115 91 0731	Cooley svorka atraumatická; 20,0 cm	Cooley atrauma forceps; 20.0 cm	156
115 91 0732	Cooley svorka atraumatická; 17,0 cm	Cooley atrauma forceps; 17.0 cm	156
115 91 0733	Cooley svorka atraumatická; 17,0 cm	Cooley atrauma forceps; 17.0 cm	156
115 91 0734	Cooley svorka atraumatická; 17,0 cm	Cooley atrauma forceps; 17.0 cm	157
115 91 0735	Cooley svorka atraumatická; 17,0 cm	Cooley atrauma forceps; 17.0 cm	157
115 91 0736	Cooley svorka atraumatická; 17,0 cm	Cooley atrauma forceps; 17.0 cm	157
115 91 0737	Cooley svorka atraumatická; 15,0 cm	Cooley atrauma forceps; 15.0 cm	157
115 91 0738	Cooley svorka atraumatická; 16,0 cm	Cooley atrauma forceps; 16.0 cm	157
115 91 0739	Cooley svorka atraumatická; 16,0 cm	Cooley atrauma forceps; 16.0 cm	158
115 91 0740	Cooley svorka atraumatická; 17,0 cm	Cooley atrauma forceps; 17.0 cm	158
115 91 0741	Cooley svorka atraumatická; 17,0 cm	Cooley atrauma forceps; 17.0 cm	158
115 91 0742	Cooley svorka atraumatická; 16,0 cm	Cooley atrauma forceps; 16.0 cm	158
115 91 0743	Cooley-Derra svorka atraumatická; 16,0 cm	Cooley-Derra atrauma forceps; 16.0 cm	159
115 91 0744	Cooley-Derra svorka atraumatická; 17,0 cm	Cooley-Derra atrauma forceps; 17.0 cm	159
115 91 0745	Cooley-Derra svorka atraumatická; 18,0 cm	Cooley-Derra atrauma forceps; 18.0 cm	159
115 91 0746	Beck svorka atraumatická; 17,0 cm	Beck atrauma forceps; 17.0 cm	159
115 91 0747	Dardik svorka atraumatická; 90°; 13,0 cm	Dardik atrauma forceps; 90°; 13.0 cm	160
115 91 0748	Dardik svorka atraumatická; 45°; 14,5 cm	Dardik atrauma forceps; 45°; 14.5 cm	160
115 91 0749	Dardik svorka atraumatická; 30°; 15,0 cm	Dardik atrauma forceps; 30°; 15.0 cm	160
115 91 0750	Dardik svorka atraumatická; 15°; 15,0 cm	Dardik atrauma forceps; 15°; 15.0 cm	160

číslo – number	název	item	strana – page
115 91 0751	Dardik svorka atraumatická; 15,0 cm	Dardik atrauma forceps; 15.0 cm	160
115 91 0752	Dardik svorka atraumatická; 90°; 13,5 cm	Dardik atrauma forceps; 90°; 13.5 cm	160
115 91 0753	Dardik svorka atraumatická; 45°; 16,0 cm	Dardik atrauma forceps; 45°; 16.0 cm	160
115 91 0754	Dardik svorka atraumatická; 30°; 17,0 cm	Dardik atrauma forceps; 30°; 17.0 cm	160
115 91 0755	Dardik svorka atraumatická; 15°; 17,0 cm	Dardik atrauma forceps; 15°; 17.0 cm	160
115 91 0756	Dardik svorka atraumatická; 15,0 cm	Dardik atrauma forceps; 15.0 cm	160
115 91 0757	Cooley svorka atraumatická; 14,0 cm	Cooley atrauma forceps; 14.0 cm	161
115 91 0758	Cooley svorka atraumatická; 14,0 cm	Cooley atrauma forceps; 14.0 cm	161
115 91 0759	Cooley svorka atraumatická; 14,0 cm	Cooley atrauma forceps; 14.0 cm	161
115 91 0760	Svorka atraumatická; 14,0 cm	Atrauma forceps; 14.0 cm	162
115 91 0761	Svorka atraumatická; 14,0 cm	Atrauma forceps; 14.0 cm	162
115 91 0762	Svorka atraumatická; 14,0 cm	Atrauma forceps; 14.0 cm	162
115 91 0763	Svorka atraumatická; 13,0 cm	Atrauma forceps; 13.0 cm	162
115 91 0764	Svorka atraumatická; 14,0 cm	Atrauma forceps; 14.0 cm	162
115 91 0765	Svorka atraumatická; 13,0 cm	Atrauma forceps; 13.0 cm	162
115 91 0766	Svorka atraumatická; 13,0 cm	Atrauma forceps; 13.0 cm	162
115 91 0767	Svorka atraumatická; 14,0 cm	Atrauma forceps; 14.0 cm	162
115 91 0768	Svorka atraumatická; 13,5 cm	Atrauma forceps; 13.5 cm	162
115 91 0769	Svorka atraumatická; 16,5 cm	Atrauma forceps; 16.5 cm	163
115 91 0770	Svorka atraumatická; 16,0 cm	Atrauma forceps; 16.0 cm	163
115 91 0771	Svorka atraumatická; 15,0 cm	Atrauma forceps; 15.0 cm	163
115 91 0772	Svorka atraumatická; 15,0 cm	Atrauma forceps; 15.0 cm	163
115 91 0773	Svorka atraumatická; 15,5 cm	Atrauma forceps; 15.5 cm	163
115 91 0774	Svorka atraumatická; 13,0 cm	Atrauma forceps; 13.0 cm	164
115 91 0775	Svorka atraumatická; 13,0 cm	Atrauma forceps; 13.0 cm	164
115 91 0776	Svorka atraumatická; 11,0 cm	Atrauma forceps; 11.0 cm	164
115 91 0777	Svorka atraumatická; 12,0 cm	Atrauma forceps; 12.0 cm	164
115 91 0778	Svorka atraumatická; 12,0 cm	Atrauma forceps; 12.0 cm	164
115 91 0779	Svorka atraumatická; 12,0 cm	Atrauma forceps; 12.0 cm	164
115 91 0780	Svorka atraumatická; 12,0 cm	Atrauma forceps; 12.0 cm	164
115 91 0781	De Bakey svorka atraumatická; 12,0 cm	De Bakey atrauma forceps; 12.0 cm	165
115 91 0782	De Bakey svorka atraumatická; 13,0 cm	De Bakey atrauma forceps; 13.0 cm	165
115 91 0783	De Bakey svorka atraumatická; 10,0 cm	De Bakey atrauma forceps; 10.0 cm	165
115 91 0784	De Bakey svorka atraumatická; 11,0 cm	De Bakey atrauma forceps; 11.0 cm	165
115 91 0785	De Bakey svorka atraumatická; 12,0 cm	De Bakey atrauma forceps; 12.0 cm	165
115 91 0786	Subramanian-miniature svorka atraumatická	Subramanian-miniature atrauma forceps	166
115 91 0787	Subramanian svorka atraumatická; 16,0 cm	Subramanian atrauma forceps; 16.0 cm	166
115 91 0788	Subramanian svorka atraumatická; 16,0 cm	Subramanian atrauma forceps; 16.0 cm	166
115 91 0796	Satinsky svorka cévní; 26,0 cm	Satinsky vena-veva forceps; 26.0 cm	167
115 91 0797	Satinsky svorka cévní; 26,0 cm	Satinsky vena-veva forceps; 26.0 cm	167
115 91 0798	Baby-Satinsky svorka cévní; 15,0 cm	Baby-Satinsky vena-veva forceps; 15.0 cm	167
115 91 0799	Harken svorka na cévy; 24,0 cm	Harken vena-veva forceps; 24.0 cm	167
115 91 0800	Harken svorka na cévy; 24,0 cm	Harken vena-veva forceps; 24.0 cm	167
115 91 0801	Harken svorka na cévy; 24,0 cm	Harken vena-veva forceps; 24.0 cm	167
115 91 0804	Hoehn svorka na cévy jemná; 13,5 cm	Hoehn artery forceps curved; 13.5 cm	510
115 91 0805	Raimondi svorka na cévy jemná; 12,5 cm	Raimondi artery forceps curved; 12.5 cm	510
115 91 0806	Svorka preparační; 19,5 cm	Dissecting forceps curved; 19.5 cm	510
115 91 0807	Svorka preparační; 19,5 cm	Dissecting forceps curved; 19.5 cm	510
115 91 0808	Nástroj mikro; 18,5 cm	Micro-instrument; 18.5 cm	511
115 91 0809	Nástroj mikro; 18,5 cm	Micro-instrument; 18.5 cm	511
116 08 0030	Luer kleště štípací na kosti rovné; 17,0 cm	Luer bone rongeur; 17.0 cm	174
116 08 0040	Luer kleště štípací na kosti slabě zahnuté; 17,0 cm	Luer bone rongeur; 17.0 cm	174
116 08 0070	Luer kleště štípací na kosti silně zahnuté; 15,0 cm	Luer bone rongeur; 15.0 cm	174
116 08 0080	Luer kleště štípací na kosti zahnuté; 14,5 cm	Luer bone rongeur; 14.5 cm	174
116 08 0090	Ruskin kleště štípací na kosti zahnuté; 20,0 cm	Ruskin bone rongeur; 20.0 cm	174
116 08 0130	Luer kleště štípací na kosti lomené; 24,0 cm	Luer bone rongeur; 24.0 cm	174
116 08 0140	Luer kleště štípací na kosti zahnuté; 27,0 cm	Luer bone rongeur; 27.0 cm	175
116 08 0150	Luer kleště štípací na kosti mírně lomené; 24,0 cm	Luer bone rongeur; 24.0 cm	175
116 08 0160	Luer kleště štípací na kosti lomené; 23,0 cm	Luer bone rongeur; 23.0 cm	175
116 08 0180	Luer kleště štípací na kosti rovné; 22,0 cm	Luer bone rongeur; 22.0 cm	176
116 08 0190	Luer-Stille kleště štípací na kosti zahnuté; 22,0 cm	Luer-Stille bone rongeur; 22.0 cm	176
116 08 0410	Liston kleště štípací na kosti rovné; 14,0 cm	Liston bone rongeur; 14.0 cm	179
116 08 0440	Liston kleště štípací na kosti rovné; 19,0 cm	Liston bone rongeur; 19.0 cm	179
116 08 0450	Liston kleště štípací na kosti zahnuté; 19,0 cm	Liston bone rongeur; 19.0 cm	179
116 08 0470	Liston kleště štípací na kosti dvojité zahnuté; 27,0 cm	Liston bone rongeur; 27.0 cm	180
116 17 0330	Zielke štípek meziobratlový; 20,0 cm	Zielke laminectomy rongeur; 20.0 cm	512
116 17 0360	Kleště na meziobratlové ploténky; 12x2 mm; 14,0 cm	Laminectomy rongeur; 12x2 mm; 14.0 cm	513
116 17 0380	Kleště na meziobratlové ploténky; 12x3 mm; 14,0 cm	Laminectomy rongeur; 12x3 mm; 14.0 cm	513
116 17 0390	Kleště na meziobratlové ploténky; 12x4 mm; 14,0 cm	Laminectomy rongeur; 12x4 mm; 14.0 cm	513
116 17 0400	Kleště na meziobratlové ploténky; 12x5 mm; 14,0 cm	Laminectomy rongeur; 12x5 mm; 14.0 cm	513
116 17 0410	Kleště na meziobratlové ploténky; 12x6 mm; 14,0 cm	Laminectomy rongeur; 12x6 mm; 14.0 cm	513
116 17 0600	Kleště na meziobratlové ploténky se zuby; 12x2 mm; 16,0 cm	Laminectomy rongeur; 12x2 mm; 16.0 cm	513
116 17 0620	Kleště na meziobratlové ploténky se zuby; 12x3 mm; 16,0 cm	Laminectomy rongeur; 12x3 mm; 16.0 cm	513
116 17 0630	Kleště na meziobratlové ploténky se zuby; 13x4 mm; 16,0 cm	Laminectomy rongeur; 13x4 mm; 16.0 cm	513
116 17 0640	Kleště na meziobratlové ploténky se zuby; 13x5 mm; 16,0 cm	Laminectomy rongeur; 13x5 mm; 16.0 cm	513
116 17 0840	Kleště na meziobratlové ploténky; 12x2 mm; 18,0 cm	Laminectomy rongeur; 12x2 mm; 18.0 cm	513
116 17 0860	Kleště na meziobratlové ploténky; 12x3 mm; 18,0 cm	Laminectomy rongeur; 12x3 mm; 18.0 cm	513
116 17 0870	Kleště na meziobratlové ploténky; 13x4 mm; 18,0 cm	Laminectomy rongeur; 13x4 mm; 18.0 cm	513
116 17 0880	Kleště na meziobratlové ploténky; 13x5 mm; 18,0 cm	Laminectomy rongeur; 13x5 mm; 18.0 cm	513
116 17 0890	Kleště na meziobratlové ploténky; 12x6 mm; 18,0 cm	Laminectomy rongeur; 12x6 mm; 18.0 cm	513
116 29 0010	Hartmann kleště na ušní polypy; 14,0 cm	Hartmann ear polypus forceps; 14.0 cm	390
116 29 0030	Hartmann kleště na ušní polypy; 14,0 cm	Hartmann ear polypus forceps; 14.0 cm	390
116 29 0300	Strümpel kleště na ušní polypy; 2,2x7,0 mm	Strümpel ear polypus forceps; 2.2x7.0 mm	374
116 29 0400	Jansen kleště ušní štípací fig.1; 18,0 cm	Jansen mastoid forceps fig.1; 18.0 cm	380

číslo – number	název	item	strana – page
116 29 0410	Jansen kleště ušní štípací fig.2; 18,0 cm	Jansen mastoid forceps fig.2; 18.0 cm	380
116 91 0001	Kleště štípací na drát; 14,5 cm	Wire forceps; 14.5 cm	184
116 91 0004	Kleště štípací na drát; 18,0 cm	Wire cutting forceps; 18.0 cm	184
116 91 0005	Kleště štípací na drát; 17,0 cm	Wire cutting forceps; 17.0 cm	184
116 91 0006	Kleště štípací na drát; 22,0 cm	Wire cutting forceps; 22.0 cm	184
116 91 0007	Kleště štípací na drát; 47,0 cm	Wire cutting forceps; 47.0 cm	186
116 91 0008	Hercules kleště štípací na drát; 28,0 cm	Hercules wire cutting forceps; 28.0 cm	186
116 91 0009	Sada čelistí pro štípací kleště Hercules	Set of jaws for forceps Hercules	186
116 91 0010	Kleště štípací na drát; 21,5 cm	Wire cutting forceps; 21.5 cm	185
116 91 0011	Kleště štípací na drát; 23,0 cm	Wire cutting forceps; 23.0 cm	185
116 91 0013	Echlin kleště štípací; 2 mm; 23,0 cm	Echlin bone rongeur; 2 mm; 23.0 cm	177
116 91 0014	Echlin kleště štípací; 3 mm; 23,0 cm	Echlin bone rongeur; 3 mm; 23.0 cm	177
116 91 0015	Echlin kleště štípací; 4 mm; 23,0 cm	Echlin bone rongeur; 4 mm; 23.0 cm	177
116 91 0017	Mini-Friedman kleště štípací na kosti; 12,0 cm	Mini-Friedman bone rongeur; 12.0 cm	173
116 91 0019	Luc kleště na nosní přepážku; 20,0 cm	Luc septum forceps; 20.0 cm	379
116 91 0020	Luc kleště na nosní přepážku; 20,0 cm	Luc septum forceps; 20.0 cm	379
116 91 0021	Luc kleště na nosní přepážku; 20,0 cm	Luc septum forceps; 20.0 cm	379
116 91 0022	Tischler kleště na biopsii; 22,0 cm	Tischler biopsy forceps; 22.0 cm	449
116 91 0023	Luc kleště na nosní přepážku; 20,0 cm	Luc septum forceps; 20.0 cm	379
116 91 0024	Baby-Tischler kleště na biopsii; 20,0 cm	Baby-Tischler biopsy forceps; 20.0 cm	449
116 91 0025	Tischler-Morgan kleště na biopsii; 22,0 cm	Tischler-Morgan biopsy forceps; 22.0 cm	449
116 91 0026	Gellhorn kleště na biopsii; 23,0 cm	Geelhorn biopsy forceps; 23.0 cm	450
116 91 0027	Faure kleště na biopsii; 23,0 cm	Faure biopsy forceps; 23.0 cm	450
116 91 0028	Schubert kleště na biopsii; 21,0 cm	Schubert biopsy forceps; 21.0 cm	450
116 91 0029	Schubert kleště na biopsii; 29,0 cm	Schubert biopsy forceps; 29.0 cm	450
116 91 0030	Thoms-Gaylor kleště na biopsii; 24,0 cm	Thoms-Gaylor biopsy forceps; 24.0 cm	451
116 91 0031	Schubert kleště na biopsii; 26,0 cm	Schubert biopsy forceps; 26.0 cm	451
116 91 0032	Tischler kleště na biopsii; 27,0 cm	Tischler biopsy forceps; 27.0 cm	451
116 91 0033	Schumacher-Van Doren kleště na biopsii fig. 1	Schumacher-Van Doren biopsy forceps fig. 1	452
116 91 0034	Schumacher-Van Doren kleště na biopsii fig. 2	Schumacher-Van Doren biopsy forceps fig. 2	452
116 91 0035	Van Doren kleště na biopsii; 25,0 cm	Van Doren biopsy forceps; 25.0 cm	452
116 91 0036	Van Doren kleště na biopsii; 25,0 cm	Van Doren biopsy forceps; 25.0 cm	452
116 91 0037	Alexander kleště na biopsii; 20,0 cm	Alexander biopsy forceps; 20.0 cm	453
116 91 0038	Kevorkian kleště na biopsii; 23,0 cm	Kevorkian biopsy forceps; 23.0 cm	453
116 91 0039	Kevorkian kleště na biopsii; 25,0 cm	Kevorkian biopsy forceps; 25.0 cm	453
116 91 0040	Schumacher kleště na biopsii fig. 1; 24,0 cm	Schumacher biopsy forceps fig. 1; 24.0 cm	453
116 91 0041	Schumacher kleště na biopsii fig. 2; 24,0 cm	Schumacher biopsy forceps fig. 2; 24.0 cm	453
116 91 0042	Wittner kleště na biopsii; 23,0 cm	Wittner biopsy forceps; 23.0 cm	453
116 91 0043	Wittner kleště na biopsii lomené; 23,0 cm	Wittner biopsy forceps; 23.0 cm	453
116 91 0044	Douay kleště na biopsii; 20,0 cm	Douay biopsy forceps; 20.0 cm	454
116 91 0045	Douay kleště na biopsii; 25,0 cm	Douay biopsy forceps; 25.0 cm	454
116 91 0046	Douay kleště na biopsii; 30,0 cm	Douay biopsy forceps; 30.0 cm	454
116 91 0047	Douay kleště na biopsii; 35,0 cm	Douay biopsy forceps; 35.0 cm	454
116 91 0048	Douay kleště na biopsii; 40,0 cm	Douay biopsy forceps; 40.0 cm	454
116 91 0049	Tischler držadlo	Tischler handle	455
116 91 0050	Tischler koncovka; 25,0 cm	Tischler tip; 25.0 cm	455
116 91 0051	Kevorkian koncovka; 25,0 cm	Kevorkian biopsy tip; 25.0 cm	455
116 91 0052	Eppendorf koncovka; 25,0 cm	Eppendorf biopsy tip; 25.0 cm	455
116 91 0053	Mini-Townsend koncovka; 25,0 cm	Mini-Townsend biopsy tip; 25.0 cm	455
116 91 0054	Eppendorf kleště na biopsii; 20,0 cm	Eppendorpf biopsy forceps; 20.0 cm	454
116 91 0055	Eppendorf kleště na biopsii; 23,0 cm	Eppendorpf biopsy forceps; 23.0 cm	454
116 91 0056	Hartmann štípek na mandle fig. 1; 13,0 cm	Hartmann tonsil punch fig.1; 13.0 cm	382
116 91 0057	Hartmann štípek na mandle fig. 2; 13,0 cm	Hartmann tonsil punch fig.2; 13.0 cm	382
116 91 0058	Hartmann štípek na mandle fig. 3; 13,0 cm	Hartmann tonsil punch fig.3; 13.0 cm	382
116 91 0062	Chevalier-Jackson kleště hrtanové fig.1; 30,0 cm	Chevalier-Jackson laryngeal forceps fig.1; 30.0 cm	383
116 91 0063	Chevalier-Jackson kleště hrtanové fig.1; 40,0 cm	Chevalier-Jackson laryngeal forceps fig.1; 40.0 cm	383
116 91 0064	Chevalier-Jackson kleště hrtanové fig.1; 50,0 cm	Chevalier-Jackson laryngeal forceps fig.1; 50.0 cm	383
116 91 0065	Chevalier-Jackson kleště hrtanové fig.1; 60,0 cm	Chevalier-Jackson laryngeal forceps fig.1; 60.0 cm	383
116 91 0066	Chevalier-Jackson kleště hrtanové fig.2; 30,0 cm	Chevalier-Jackson laryngeal forceps fig.2; 30.0 cm	383
116 91 0067	Chevalier-Jackson kleště hrtanové fig.2; 40,0 cm	Chevalier-Jackson laryngeal forceps fig.2; 40.0 cm	383
116 91 0068	Chevalier-Jackson kleště hrtanové fig.2; 50,0 cm	Chevalier-Jackson laryngeal forceps fig.2; 50.0 cm	383
116 91 0069	Chevalier-Jackson kleště hrtanové fig.2; 60,0 cm	Chevalier-Jackson laryngeal forceps fig.2; 60.0 cm	383
116 91 0070	Chevalier Jackson kleště hrtanové fig.3; 30,0 cm	Chevalier-Jackson laryngeal forceps fig.3; 30.0 cm	383
116 91 0071	Chevalier-Jackson kleště hrtanové fig.3; 40,0 cm	Chevalier-Jackson laryngeal forceps fig.3; 40.0 cm	383
116 91 0072	Chevalier-Jackson kleště hrtanové fig.3; 50,0 cm	Chevalier-Jackson laryngeal forceps fig.3; 50.0 cm	383
116 91 0073	Chevalier-Jackson kleště hrtanové fig.3; 60,0 cm	Chevalier-Jackson laryngeal forceps fig.3; 60.0 cm	383
116 91 0074	Chevalier-Jackson kleště hrtanové fig.4; 30,0 cm	Chevalier-Jackson laryngeal forceps fig.4; 30.0 cm	383
116 91 0075	Chevalier-Jackson kleště hrtanové fig.4; 40,0 cm	Chevalier-Jackson laryngeal forceps fig.4; 40.0 cm	383
116 91 0076	Chevalier-Jackson kleště hrtanové fig.4; 50,0 cm	Chevalier-Jackson laryngeal forceps fig.4; 50.0 cm	383
116 91 0077	Chevalier-Jackson kleště hrtanové fig.4; 60,0 cm	Chevalier-Jackson laryngeal forceps fig.4; 60.0 cm	383
116 91 0078	Chevalier-Jackson kleště hrtanové fig.5; 30,0 cm	Chevalier-Jackson laryngeal forceps fig.5; 30.0 cm	383
116 91 0079	Chevalier-Jackson kleště hrtanové fig.5; 40,0 cm	Chevalier-Jackson laryngeal forceps fig.5; 40.0 cm	383
116 91 0080	Chevalier-Jackson kleště hrtanové fig.5; 50,0 cm	Chevalier-Jackson laryngeal forceps fig.5; 50.0 cm	383
116 91 0081	Chevalier-Jackson kleště hrtanové fig.5; 60,0 cm	Chevalier-Jackson laryngeal forceps fig.5; 60.0 cm	383
116 91 0082	Chevalier-Jackson kleště hrtanové fig.6; 30,0 cm	Chevalier-Jackson laryngeal forceps fig.6; 30.0 cm	383
116 91 0083	Chevalier-Jackson kleště hrtanové fig.6; 40,0 cm	Chevalier-Jackson laryngeal forceps fig.6; 40.0 cm	383
116 91 0084	Chevalier-Jackson kleště hrtanové fig.6; 50,0 cm	Chevalier-Jackson laryngeal forceps fig.6; 50.0 cm	383
116 91 0085	Chevalier-Jackson kleště hrtanové fig.6; 60,0 cm	Chevalier-Jackson laryngeal forceps fig.6; 60.0 cm	383
116 91 0086	Chevalier-Jackson kleště hrtanové fig.7; 30,0 cm	Chevalier-Jackson laryngeal forceps fig.7; 30.0 cm	383
116 91 0087	Chevalier-Jackson kleště hrtanové fig.7; 40,0 cm	Chevalier-Jackson laryngeal forceps fig.7; 40.0 cm	383
116 91 0088	Chevalier-Jackson kleště hrtanové fig.7; 50,0 cm	Chevalier-Jackson laryngeal forceps fig.7; 50.0 cm	383
116 91 0089	Chevalier-Jackson kleště hrtanové fig.7; 60,0 cm	Chevalier-Jackson laryngeal forceps fig.7; 60.0 cm	383
116 91 0090	Chevalier-Jackson kleště hrtanové fig.8; 30,0 cm	Chevalier-Jackson laryngeal forceps fig.8; 30.0 cm	383
116 91 0091	Chevalier-Jackson kleště hrtanové fig.8; 40,0 cm	Chevalier-Jackson laryngeal forceps fig.8; 40.0 cm	383

číslo – number	název	item	strana – page
116 91 0092	Chevalier-Jackson kleště hrtanové fig.8; 50,0 cm	Chevalier-Jackson laryngeal forceps fig.8; 50.0 cm	383
116 91 0093	Chevalier-Jackson kleště hrtanové fig.8; 60,0 cm	Chevalier-Jackson laryngeal forceps fig.8; 60.0 cm	383
116 91 0094	Chevalier-Jackson kleště hrtanové fig.9; 30,0 cm	Chevalier-Jackson laryngeal forceps fig.9; 30.0 cm	383
116 91 0095	Chevalier-Jackson kleště hrtanové fig.9; 40,0 cm	Chevalier-Jackson laryngeal forceps fig.9; 40.0 cm	383
116 91 0096	Chevalier-Jackson kleště hrtanové fig.9; 50,0 cm	Chevalier-Jackson laryngeal forceps fig.9; 50.0 cm	383
116 91 0097	Chevalier-Jackson kleště hrtanové fig.9; 60,0 cm	Chevalier-Jackson laryngeal forceps fig.9; 60.0 cm	383
116 91 0098	Chevalier-Jackson kleště hrtanové fig.10; 30,0 cm	Chevalier-Jackson laryngeal forceps fig.10; 30.0 cm	383
116 91 0099	Chevalier-Jackson kleště hrtanové fig.10; 40,0 cm	Chevalier-Jackson laryngeal forceps fig.10; 40.0 cm	383
116 91 0100	Chevalier-Jackson kleště hrtanové fig.10; 50,0 cm	Chevalier-Jackson laryngeal forceps fig.10; 50.0 cm	383
116 91 0101	Chevalier-Jackson kleště hrtanové fig.10; 60,0 cm	Chevalier-Jackson laryngeal forceps fig.10; 60.0 cm	383
116 91 0102	Chevalier-Jackson kleště hrtanové fig.11; 30,0 cm	Chevalier-Jackson laryngeal forceps fig.11; 30.0 cm	383
116 91 0103	Chevalier-Jackson kleště hrtanové fig.11; 40,0 cm	Chevalier-Jackson laryngeal forceps fig.11; 40.0 cm	383
116 91 0104	Chevalier-Jackson kleště hrtanové fig.11; 50,0 cm	Chevalier-Jackson laryngeal forceps fig.11; 50.0 cm	383
116 91 0105	Chevalier-Jackson kleště hrtanové fig.11; 60,0 cm	Chevalier-Jackson laryngeal forceps fig.11; 60.0 cm	383
116 91 0106	Huber držadlo univerzální	Huber universal handle	384
116 91 0107	Bruenings koncovka rovná; 20,0 cm	Bruenings tip straight; 20.0 cm	384
116 91 0108	Bruenings koncovka rovná; 30,0 cm	Bruenings tip straight; 30.0 cm	384
116 91 0109	Bruenings koncovka rovná; 40,0 cm	Bruenings tip straight; 40.0 cm	384
116 91 0110	Bruenings koncovka rovná; 50,0 cm	Bruenings tip straight; 50.0 cm	384
116 91 0111	Bruenings koncovka rovná; 60,0 cm	Bruenings tip straight; 60.0 cm	384
116 91 0112	Bruenings koncovka zahnutá pevná; 20,0 cm	Bruenings tip curved rigid; 20.0 cm	384
116 91 0113	Bruenings koncovka zahnutá ohebná; 20,0 cm	Bruenings tip curved malleable; 20.0 cm	384
116 91 0114	Fraenkel koncovka	Fraenkel tip	385
116 91 0115	Seiffert koncovka	Seiffert tip	385
116 91 0116	Fraenkel koncovka misková	Fraenkel tip	385
116 91 0117	Scheinmann koncovka misková	Scheinmann tip	385
116 91 0118	Scheinmann grid koncovka	Scheinmann grid tip	385
116 91 0119	Bruenings koncovka; 2 mm	Bruenings tip; 2 mm	385
116 91 0120	Bruenings koncovka; 3 mm	Bruenings tip; 3 mm	385
116 91 0121	Bruenings koncovka; 4 mm	Bruenings tip; 4 mm	385
116 91 0122	Bruenings koncovka oválná	Bruenings tip	385
116 91 0123	Bruenings koncovka oválná	Bruenings tip	385
116 91 0124	Lange koncovka	Lange tip	385
116 91 0125	Krause koncovka; 2,5 mm	Krause tip; 2.5 mm	385
116 91 0126	Krause koncovka; 3,5 mm	Krause tip; 3.5 mm	385
116 91 0127	Krause koncovka; plochá	Krause tip; plochá	385
116 91 0128	Cordes koncovka fig.1	Cordes tip fig.1	385
116 91 0129	Cordes koncovka fig.2	Cordes tip fig.2	385
116 91 0130	Cordes koncovka fig.3	Cordes tip fig.3	385
116 91 0131	Cordes koncovka fig.4	Cordes tip fig.4	385
116 91 0132	Schumacher koncovka	Schumacher tip	385
116 91 0133	Cordes koncovka fig.1	Cordes tip fig.1	385
116 91 0134	Cordes koncovka fig.2	Cordes tip fig.2	385
116 91 0135	Cordes koncovka	Cordes tip	385
116 91 0136	Rosenberg koncovka	Rosenberg tip	385
116 91 0137	Kleště mikro miskové rovné; 25,0 cm	Forceps micro straight; 25.0 cm	386
116 91 0138	Kleště mikro miskové zahnuté vpravo; 2 mm; 25,0 cm	Forceps micro curved right; 2 mm; 25.0 cm	386
116 91 0139	Kleště mikro miskové zahnuté vlevo; 2 mm; 25,0 cm	Forceps micro curved left; 2 mm; 25.0 cm	386
116 91 0140	Gluck kleště na žebra vyťahovací; 22 cm	Gluck pulling forceps for ribs; 22 cm	182
116 91 0143	Kleště na bronchoskopii; 30,0 cm	Bronchoscopy forceps; 30.0 cm	386
116 91 0144	Kleště na bronchoskopii; 35,0 cm	Bronchoscopy forceps; 35.0 cm	386
116 91 0145	Kleště na bronchoskopii; 40,0 cm	Bronchoscopy forceps; 40.0 cm	386
116 91 0146	Kleště na bronchoskopii; 45,0 cm	Bronchoscopy forceps; 45.0 cm	386
116 91 0147	Kleště na bronchoskopii; 50,0 cm	Bronchoscopy forceps; 50.0 cm	386
116 91 0148	Kleště na bronchoskopii; 55,0 cm	Bronchoscopy forceps; 55.0 cm	386
116 91 0149	Kleště na bronchoskopii; 60,0 cm	Bronchoscopy forceps; 60.0 cm	386
116 91 0150	Kleště na bronchoskopii; 30,0 cm	Bronchoscopy forceps; 30.0 cm	386
116 91 0151	Kleště na bronchoskopii; 35,0 cm	Bronchoscopy forceps; 35.0 cm	386
116 91 0152	Kleště na bronchoskopii; 40,0 cm	Bronchoscopy forceps; 40.0 cm	386
116 91 0153	Kleště na bronchoskopii; 45,0 cm	Bronchoscopy forceps; 45.0 cm	386
116 91 0154	Kleště na bronchoskopii; 50,0 cm	Bronchoscopy forceps; 50.0 cm	386
116 91 0155	Kleště na bronchoskopii; 55,0 cm	Bronchoscopy forceps; 55.0 cm	386
116 91 0156	Kleště na bronchoskopii; 60,0 cm	Bronchoscopy forceps; 60.0 cm	386
116 91 0157	Kleště na bronchoskopii; 30,0 cm	Bronchoscopy forceps; 30.0 cm	386
116 91 0158	Kleště na bronchoskopii; 35,0 cm	Bronchoscopy forceps; 35.0 cm	386
116 91 0159	Kleště na bronchoskopii; 40,0 cm	Bronchoscopy forceps; 40.0 cm	386
116 91 0160	Kleště na bronchoskopii; 45,0 cm	Bronchoscopy forceps; 45.0 cm	386
116 91 0161	Kleště na bronchoskopii; 50,0 cm	Bronchoscopy forceps; 50.0 cm	386
116 91 0162	Kleště na bronchoskopii; 55,0 cm	Bronchoscopy forceps; 55.0 cm	386
116 91 0163	Kleště na bronchoskopii; 60,0 cm	Bronchoscopy forceps; 60.0 cm	386
116 91 0164	Kleště na bronchoskopii; 30,0 cm	Bronchoscopy forceps; 30.0 cm	386
116 91 0165	Kleště na bronchoskopii; 35,0 cm	Bronchoscopy forceps; 35.0 cm	386
116 91 0166	Kleště na bronchoskopii; 40,0 cm	Bronchoscopy forceps; 40.0 cm	386
116 91 0167	Kleště na bronchoskopii; 45,0 cm	Bronchoscopy forceps; 45.0 cm	386
116 91 0168	Kleště na bronchoskopii; 50,0 cm	Bronchoscopy forceps; 50.0 cm	386
116 91 0169	Kleště na bronchoskopii; 55,0 cm	Bronchoscopy forceps; 55.0 cm	386
116 91 0170	Kleště na bronchoskopii; 60,0 cm	Bronchoscopy forceps; 60.0 cm	386
116 91 0171	Jurasz kleště na polypy fig.1; 23,0 cm	Jurasz polypus forceps fig.1; 23.0 cm	387
116 91 0172	Jurasz kleště na polypy fig.2; 23,0 cm	Jurasz polypus forceps fig.2; 23.0 cm	387
116 91 0173	Jurasz kleště na polypy fig.3; 23,0 cm	Jurasz polypus forceps fig.3; 23.0 cm	387
116 91 0174	Jurasz kleště na polypy fig.4; 23,0 cm	Jurasz polypus forceps fig.4; 23.0 cm	387
116 91 0175	Fraenkel kleště na polypy miskové; 26,5 cm	Fraenkel polypus forceps; 26.5 cm	387
116 91 0176	Lange kleště na polypy; 26,5 cm	Lange polypus forceps; 26.5 cm	387
116 91 0177	Kleště ušní mikro rovné; 8,0 cm	Micro ear forceps straight; 8.0 cm	375



číslo – number	název	item	strana – page
116 91 0178	Kleště ušní mikro zahnuté vpravo; 8,0 cm	Micro ear forceps curved right; 8,0 cm	375
116 91 0179	Kleště ušní mikro zahnuté nahoru; 8,0 cm	Micro ear forceps curved up; 8,0 cm	375
116 91 0180	Kleště ušní mikro zahnuté vlevo; 8,0 cm	Micro ear forceps curved left; 8,0 cm	375
116 91 0181	Kleště ušní mikro zahnuté dolů; 8,0 cm	Micro ear forceps curved down; 8,0 cm	375
116 91 0182	Crura-Nipper kleště ušní štípací; 8,0 cm	Crura-Nipper micro ear forceps; 8,0 cm	375
116 91 0183	McGee kleště ušní štípací; 8,0 cm	McGee micro ear forceps; 8,0 cm	375
116 91 0184	Dieter kleště štípací mikro; 8,0 cm	Dieter micro ear forceps; 8,0 cm	375
116 91 0185	Dieter kleště štípací mikro; 8,0 cm	Dieter micro ear forceps; 8,0 cm	375
116 91 0192	Weil-Blakesley kleště štípací nosní; 12,5 cm	Weil-Blakesley nasal cutting forceps; 12,5 cm	376; 433
116 91 0193	Weil-Blakesley kleště štípací nosní; 12,5 cm	Weil-Blakesley nasal cutting forceps; 12,5 cm	376; 433
116 91 0194	Weil-Blakesley kleště štípací nosní; 12,5 cm	Weil-Blakesley nasal cutting forceps; 12,5 cm	376
116 91 0195	Weil-Blakesley kleště štípací nosní; 12,5 cm	Weil-Blakesley nasal cutting forceps; 12,5 cm	376
116 91 0196	Weil-Blakesley kleště štípací nosní; 12,5 cm	Weil-Blakesley nasal cutting forceps; 12,5 cm	376
116 91 0197	Weil-Blakesley kleště štípací nosní; 12,5 cm	Weil-Blakesley nasal cutting forceps; 12,5 cm	376; 433
116 91 0198	Weil-Blakesley kleště štípací nosní; 12,5 cm	Weil-Blakesley nasal cutting forceps; 12,5 cm	376
116 91 0199	Weil-Blakesley kleště štípací nosní; 12,5 cm	Weil-Blakesley nasal cutting forceps; 12,5 cm	376
116 91 0200	Weil-Blakesley kleště štípací nosní; 12,5 cm	Weil-Blakesley nasal cutting forceps; 12,5 cm	376
116 91 0201	Weil-Blakesley kleště štípací nosní; 12,5 cm	Weil-Blakesley nasal cutting forceps; 12,5 cm	376; 432
116 91 0202	Hartmann kleště štípací nosní; 12,5 cm	Hartmann nasal cutting forceps; 12,5 cm	377
116 91 0203	Hartmann kleště štípací nosní; 12,5 cm	Hartmann nasal cutting forceps; 12,5 cm	377
116 91 0204	Hartmann kleště štípací nosní; 12,5 cm	Hartmann nasal cutting forceps; 12,5 cm	377
116 91 0205	Hartmann kleště štípací nosní; 12,5 cm	Hartmann nasal cutting forceps; 12,5 cm	377
116 91 0210	Schmeden kleště štípací nosní; 12,5 cm	Schmeden nasal cutting forceps; 12,5 cm	377
116 91 0211	Schmeden kleště štípací nosní; 12,5 cm	Schmeden nasal cutting forceps; 12,5 cm	377
116 91 0212	Schmeden kleště štípací nosní; 12,5 cm	Schmeden nasal cutting forceps; 12,5 cm	377
116 91 0213	Struycken kleště štípací nosní; 12,5 cm	Struycken nasal cutting forceps; 12,5 cm	377
116 91 0214	Struycken kleště štípací nosní; 12,5 cm	Struycken nasal cutting forceps; 12,5 cm	377
116 91 0215	Myles kleště štípací nosní; 12,5 cm	Myles nasal cutting forceps; 12,5 cm	377
116 91 0216	Myles kleště štípací nosní; 12,5 cm	Myles nasal cutting forceps; 12,5 cm	377
116 91 0217	Myles kleště štípací nosní; 12,5 cm	Myles nasal cutting forceps; 12,5 cm	377
116 91 0218	Myles kleště štípací nosní; 12,5 cm	Myles nasal cutting forceps; 12,5 cm	377
116 91 0219	Takahashi kleště štípací nosní rovné; 12,5 cm	Takahashi nasal cutting forceps straight; 12,5 cm	378
116 91 0220	Takahashi kleště štípací nosní zahnuté; 12,5 cm	Takahashi nasal cutting forceps curved; 12,5 cm	378
116 91 0221	Struycken kleště štípací nosní rovné; 12,5 cm; 1 mm	Struycken nasal cutting forceps straight; 12,5 cm; 1 mm	378
116 91 0222	Struycken kleště štípací nosní rovné; 12,5 cm; 2 mm	Struycken nasal cutting forceps straight; 12,5 cm; 2 mm	378
116 91 0223	Jansen-Middleton kleště štípací nosní; 4x20 mm; 19,0 cm	Jansen-Middleton nasal cutting forceps; 4x20 mm; 19,0 cm	378
116 91 0224	Jansen-Middleton kleště štípací nosní; 5x15 mm; 19,0 cm	Jansen-Middleton nasal cutting forceps; 5x15 mm; 19,0 cm	378
116 91 0225	Craig kleště na nosní přepážku; 5x18 mm; 17,0 cm	Craig septum forceps; 5x18 mm; 17,0 cm	379
116 91 0226	Craig-Domnick kleště na nosní přepážku; 7x18 mm; 17,0 cm	Craig-Domnick septum forceps; 7x18 mm; 17,0 cm	379
116 91 0227	Craig-Domnick kleště na nosní přepážku; 7x18 mm; 17,0 cm	Craig-Domnick septum forceps; 7x18 mm; 17,0 cm	379
116 91 0228	Bruenings kleště na nosní přepážku; 19,0 cm	Bruenings septum forceps; 19,0 cm	379; 432
116 91 0229	Bruenings kleště na nosní přepážku; 19,0 cm	Bruenings septum forceps; 19,0 cm	379; 432
116 91 0230	Bruenings kleště na nosní přepážku; 19,0 cm	Bruenings septum forceps; 19,0 cm	379; 432
116 91 0231	Bruenings kleště na nosní přepážku; 19,0 cm	Bruenings septum forceps; 19,0 cm	379; 432
116 91 0232	Knight kleště na nosní přepážku; 18,0 cm	Knight septum forceps; 18,0 cm	379
116 91 0233	Heymann kleště na nosní přepážku; 18,0 cm	Heymann septum forceps; 18,0 cm	379
116 91 0234	Heymann kleště na nosní přepážku; 18,0 cm	Heymann septum forceps; 18,0 cm	379
116 91 0235	Heymann kleště na nosní přepážku; 18,0 cm	Heymann septum forceps; 18,0 cm	379
116 91 0236	Hajak-Kofler štípací sfenoid. horní; 4x4 mm; 14,0 cm	Hajak-Kofler sphenoid punch curved up; 4x4 mm; 14,0 cm	380
116 91 0237	Hajak-Kofler štípací sfenoid. dolní; 4x4 mm; 14,0 cm	Hajak-Kofler sphenoid punch curved down; 4x4 mm; 14,0 cm	380
116 91 0238	Hajak-Kofler štípací sfenoid. horní; 3,5 x 3,5 mm; 14,0 cm	Hajak-Kofler sphenoid punch curved up; 3,5 x 3,5 mm; 14,0 cm	380
116 91 0239	Hajak-Kofler štípací sfenoid. dolní; 3,5 x 3,5 mm; 14,0 cm	Hajak-Kofler sphenoid punch curved down; 3,5 x 3,5 mm; 14,0 cm	380
116 91 0240	Kerrison štípací; 14,0 cm	Kerrison sphenoid punch; 14,0 cm	381
116 91 0241	Hajak-Claus štípací sfenoidální; 20,0 cm	Hajak-Claus sphenoid punch; 20,0 cm	381
116 91 0242	Hartmann kleště ušní štípací; 2,0 mm; 8,5 cm	Hartmann ear forceps; 2,0 mm; 8,5 cm	374
116 91 0243	Hartmann kleště ušní štípací; 2,5 mm; 8,5 cm	Hartmann ear forceps; 2,5 mm; 8,5 cm	374
116 91 0244	Hartmann kleště ušní štípací; 3,0 mm; 8,5 cm	Hartmann ear forceps; 3,0 mm; 8,5 cm	374
116 91 0245	Hartmann kleště ušní štípací; 2,0 mm; 8,5 cm	Hartmann ear forceps; 2,0 mm; 8,5 cm	374
116 91 0246	Hartmann kleště ušní štípací; 2,5 mm; 8,5 cm	Hartmann ear forceps; 2,5 mm; 8,5 cm	374
116 91 0247	Hartmann kleště ušní štípací; 3,0 mm; 8,5 cm	Hartmann ear forceps; 3,0 mm; 8,5 cm	374
116 91 0248	Strümpel kleště ušní štípací; 8,5 cm	Strümpel ear forceps; 8,5 cm	374
116 91 0249	Hartmann kleště ušní štípací; 8,5 cm	Hartmann ear forceps; 8,5 cm	374
116 91 0250	Hartmann kleště ušní štípací; 8,5 cm	Hartmann ear forceps; 8,5 cm	374
116 91 0251	Hartmann kleště ušní štípací; 8,5 cm	Hartmann ear forceps; 8,5 cm	374
116 91 0252	Kerrison štípací; 9,0 cm	Kerrison punch; 9,0 cm	381
116 91 0253	Kerrison štípací; 9,0 cm	Kerrison punch; 9,0 cm	381
116 91 0254	Kerrison štípací; 9,0 cm	Kerrison punch; 9,0 cm	381
116 91 0255	Kerrison štípací; 9,0 cm	Kerrison punch; 9,0 cm	381
116 91 0256	Giertz-Stille kleště na žebra; 27 cm	Giertz-Stille forceps for ribs; 27 cm	183
116 91 0258	Marquard kleště štípací; 20,0 cm	Marquard bone rongeur; 20,0 cm	176
116 91 0259	Mayfield kleště štípací na kosti; 17,0 cm	Mayfield bone rongeur; 17,0 cm	176
116 91 0260	Böhler kleště štípací na kosti; 15,0 cm	Böhler bone rongeur; 15,0 cm	176
116 91 0261	Böhler kleště štípací na kosti; 15,0 cm	Böhler bone rongeur; 15,0 cm	176
116 91 0262	Böhler kleště štípací na kosti; 15,0 cm	Böhler bone rongeur; 15,0 cm	176
116 91 0263	Kleinert-Kutz kleště štípací na kosti; 15,0 cm	Kleinert-Kutz bone rongeur; 15,0 cm	177
116 91 0264	Kleinert-Kutz kleště štípací na kosti; 15,0 cm	Kleinert-Kutz bone rongeur; 15,0 cm	177
116 91 0266	Beyer kleště štípací na kosti; 18,0 cm	Beyar bone rongeur; 18,0 cm	177
116 91 0267	Zaufal-Jansen kleště štípací na kosti; 18,0 cm	Zaufal-Jansen bone rongeur; 18,0 cm	177
116 91 0271	Stille-Ruskin kleště štípací; 23,0 cm	Stille-Ruskin bone rongeur; 23,0 cm	177
116 91 0280	Ruskin kleště štípací; 23,0 cm	Ruskin bone rongeur; 23,0 cm	178
116 91 0281	Smith-Peterson kleště štípací; 3 mm; 24 cm	Smith-Peterson bone rongeur; 3 mm; 24 cm	178
116 91 0282	Smith-Peterson kleště štípací; 4 mm; 24 cm	Smith-Peterson bone rongeur; 4 mm; 24 cm	178
116 91 0283	Smith-Peterson kleště štípací; 5 mm; 24 cm	Smith-Peterson bone rongeur; 5 mm; 24 cm	178
116 91 0284	Smith-Peterson kleště štípací; 3 mm; 24 cm	Smith-Peterson bone rongeur; 3 mm; 24 cm	178



číslo – number	název	item	strana – page
116 91 0285	Smith-Peterson kleště štípací; 4 mm; 24 cm	Smith-Peterson bone rongeur; 4 mm; 24 cm	178
116 91 0286	Smith-Peterson kleště štípací; 5 mm; 24 cm	Smith-Peterson bone rongeur; 5 mm; 24 cm	178
116 91 0287	Cottle Kazanjian kleště štípací; 19,0 cm	Cottle Kazanjian bone rongeur; 19,0 cm	180
116 91 0288	Cleveland-Gardner kleště štípací; 16,0 cm	Cleveland-Gardner bone rongeur; 16,0 cm	180
116 91 0289	Markwalder kleště štípací; 20,0 cm	Markwalder bone rongeur; 20,0 cm	180
116 91 0291	Liston kleště štípací; 17,0 cm	Liston bone rongeur; 17,0 cm	179
116 91 0293	Liston kleště štípací; 22,0 cm	Liston bone rongeur; 22,0 cm	179
116 91 0294	Liston kleště štípací; 14,0 cm	Liston bone rongeur; 14,0 cm	179
116 91 0295	Liston kleště štípací; 17,0 cm	Liston bone rongeur; 17,0 cm	179
116 91 0297	Liston kleště štípací; 22,0 cm	Liston bone rongeur; 22,0 cm	179
116 91 0298	Littauer-Liston kleště štípací; 15,0 cm	Littauer-Liston bone rongeur; 15,0 cm	181
116 91 0299	Cleveland kleště štípací; 15,0 cm	Cleveland bone rongeur; 15,0 cm	181
116 91 0300	Cleveland kleště štípací; 17,0 cm	Cleveland bone rongeur; 17,0 cm	181
116 91 0301	Kleště štípací; 12,0 cm	Bone rongeur; 12,0 cm	181
116 91 0305	Walton-Liston kleště štípací; 15,0 cm	Walton-Liston bone rongeur; 15,0 cm	181
116 91 0428	Cushing kleště rovné; 2×10 mm; 13,0 cm	Cushing rongeur straight; 2×10 mm; 13,0 cm	516
116 91 0430	Cushing kleště zahnuté nahoru; 2×10 mm; 13,0 cm	Cushing rongeur up biting; 2×10 mm; 13,0 cm	516
116 91 0432	Cushing kleště zahnuté dolů; 2×10 mm; 13,0 cm	Cushing rongeur down biting; 2×10 mm; 13,0 cm	516
116 91 0434	Cushing kleště rovné; 2×10 mm; 15,0 cm	Cushing rongeur straight; 2×10 mm; 15,0 cm	516
116 91 0436	Cushing kleště zahnuté nahoru; 2×10 mm; 15,0 cm	Cushing rongeur up biting; 2×10 mm; 15,0 cm	516
116 91 0438	Cushing kleště zahnuté dolů; 2×10 mm; 15,0 cm	Cushing rongeur down biting; 2×10 mm; 15,0 cm	516
116 91 0440	Cushing kleště rovné; 2×10 mm; 18,0 cm	Cushing rongeur straight; 2×10 mm; 18,0 cm	516
116 91 0442	Cushing kleště zahnuté nahoru; 2×10 mm; 18,0 cm	Cushing rongeur up biting; 2×10 mm; 18,0 cm	516
116 91 0444	Cushing kleště zahnuté dolů; 2×10 mm; 18,0 cm	Cushing rongeur down biting; 2×10 mm; 18,0 cm	516
116 91 0446	Cushing kleště rovné; 2×10 mm; 20,0 cm	Cushing rongeur up biting; 2×10 mm; 20,0 cm	516
116 91 0447	Cushing kleště zahnuté nahoru; 2×10 mm; 20,0 cm	Cushing rongeur up biting; 2×10 mm; 20,0 cm	516
116 91 0448	Cushing kleště zahnuté dolů; 2×10 mm; 20,0 cm	Cushing rongeur down biting; 2×10 mm; 20,0 cm	516
116 91 0449	Cushing kleště rovné; 2×10 mm; 25,0 cm	Cushing rongeur straight; 2×10 mm; 25,0 cm	516
116 91 0450	Cushing kleště zahnuté nahoru; 2×10 mm; 25,0 cm	Cushing rongeur up biting; 2×10 mm; 25,0 cm	516
116 91 0451	Cushing kleště zahnuté dolů; 2×10 mm; 25,0 cm	Cushing rongeur down biting; 2×10 mm; 25,0 cm	516
116 91 0452	Cushing kleště rovné; 2×10 mm; 30,0 cm	Cushing rongeur straight; 2×10 mm; 30,0 cm	516
116 91 0453	Cushing kleště zahnuté nahoru; 2×10 mm; 30,0 cm	Cushing rongeur up biting; 2×10 mm; 30,0 cm	516
116 91 0454	Cushing kleště zahnuté dolů; 2×10 mm; 30,0 cm	Cushing rongeur down biting; 2×10 mm; 30,0 cm	516
116 91 0455	Love-Gruenwald kleště rovné; 3×10 mm; 13 cm	Love-Gruenwald rongeur straight; 3×10 mm; 13 cm	516
116 91 0456	Love-Gruenwald kleště zahnuté nahoru; 3×10 mm; 13 cm	Love-Gruenwald rongeur up biting; 3×10 mm; 13 cm	516
116 91 0457	Love-Gruenwald kleště zahnuté dolů; 3×10 mm; 13 cm	Love-Gruenwald rongeur down biting; 3×10 mm; 13 cm	516
116 91 0458	Love-Gruenwald kleště rovné; 3×10 mm; 15 cm	Love-Gruenwald rongeur straight; 3×10 mm; 15 cm	516
116 91 0459	Love-Gruenwald kleště zahnuté nahoru; 3×10 mm; 15 cm	Love-Gruenwald rongeur up biting; 3×10 mm; 15 cm	516
116 91 0460	Love-Gruenwald kleště zahnuté dolů; 3×10 mm; 15 cm	Love-Gruenwald rongeur down biting; 3×10 mm; 15 cm	516
116 91 0461	Love-Gruenwald kleště rovné; 3×10 mm; 18 cm	Love-Gruenwald rongeur straight; 3×10 mm; 18 cm	516
116 91 0462	Love-Gruenwald kleště zahnuté nahoru; 3×10 mm; 18 cm	Love-Gruenwald rongeur up biting; 3×10 mm; 18 cm	516
116 91 0463	Love-Gruenwald kleště zahnuté dolů; 3×10 mm; 18 cm	Love-Gruenwald rongeur down biting; 3×10 mm; 18 cm	516
116 91 0464	Love-Gruenwald kleště rovné; 3×10 mm; 20 cm	Love-Gruenwald rongeur straight; 3×10 mm; 20 cm	516
116 91 0465	Love-Gruenwald kleště zahnuté nahoru; 3×10 mm; 20 cm	Love-Gruenwald rongeur up biting; 3×10 mm; 20 cm	516
116 91 0466	Love-Gruenwald kleště zahnuté dolů; 3×10 mm; 20 cm	Love-Gruenwald rongeur down biting; 3×10 mm; 20 cm	516
116 91 0467	Love-Gruenwald kleště rovné; 3×10 mm; 25 cm	Love-Gruenwald rongeur straight; 3×10 mm; 25 cm	516
116 91 0468	Love-Gruenwald kleště zahnuté nahoru; 3×10 mm; 25 cm	Love-Gruenwald rongeur up biting; 3×10 mm; 25 cm	516
116 91 0469	Love-Gruenwald kleště zahnuté dolů; 3×10 mm; 25 cm	Love-Gruenwald rongeur down biting; 3×10 mm; 25 cm	516
116 91 0470	Love-Gruenwald kleště rovné; 3×10 mm; 30 cm	Love-Gruenwald rongeur straight; 3×10 mm; 30 cm	516
116 91 0471	Love-Gruenwald kleště zahnuté nahoru; 3×10 mm; 30 cm	Love-Gruenwald rongeur up biting; 3×10 mm; 30 cm	516
116 91 0472	Love-Gruenwald kleště zahnuté dolů; 3×10 mm; 30 cm	Love-Gruenwald rongeur down biting; 3×10 mm; 30 cm	516
116 91 0473	Spurling kleště rovné; 4×10 mm; 13 cm	Spurling rongeur straight; 4×10 mm; 13 cm	516
116 91 0474	Spurling kleště zahnuté nahoru; 4×10 mm; 13 cm	Spurling rongeur up biting; 4×10 mm; 13 cm	516
116 91 0475	Spurling kleště zahnuté dolů; 4×10 mm; 13 cm	Spurling rongeur down biting; 4×10 mm; 13 cm	516
116 91 0476	Spurling kleště rovné; 4×10 mm; 15 cm	Spurling rongeur straight; 4×10 mm; 15 cm	516
116 91 0477	Spurling kleště zahnuté nahoru; 4×10 mm; 15 cm	Spurling rongeur up biting; 4×10 mm; 15 cm	516
116 91 0478	Spurling kleště zahnuté dolů; 4×10 mm; 15 cm	Spurling rongeur down biting; 4×10 mm; 15 cm	516
116 91 0479	Spurling kleště rovné; 4×10 mm; 18 cm	Spurling rongeur straight; 4×10 mm; 18 cm	516
116 91 0480	Spurling kleště zahnuté nahoru; 4×10 mm; 18 cm	Spurling rongeur up biting; 4×10 mm; 18 cm	516
116 91 0481	Spurling kleště zahnuté dolů; 4×10 mm; 18 cm	Spurling rongeur down biting; 4×10 mm; 18 cm	516
116 91 0482	Spurling kleště rovné; 4×10 mm; 20 cm	Spurling rongeur straight; 4×10 mm; 20 cm	516
116 91 0483	Spurling kleště zahnuté nahoru; 4×10 mm; 20 cm	Spurling rongeur up biting; 4×10 mm; 20 cm	516
116 91 0484	Spurling kleště zahnuté dolů; 4×10 mm; 20 cm	Spurling rongeur down biting; 4×10 mm; 20 cm	516
116 91 0485	Spurling kleště rovné; 4×10 mm; 25 cm	Spurling rongeur straight; 4×10 mm; 25 cm	516
116 91 0486	Spurling kleště zahnuté nahoru; 4×10 mm; 25 cm	Spurling rongeur up biting; 4×10 mm; 25 cm	516
116 91 0487	Spurling kleště zahnuté dolů; 4×10 mm; 25 cm	Spurling rongeur down biting; 4×10 mm; 25 cm	516
116 91 0488	Spurling kleště rovné; 4×10 mm; 30 cm	Spurling rongeur straight; 4×10 mm; 30 cm	516
116 91 0489	Spurling kleště zahnuté nahoru; 4×10 mm; 30 cm	Spurling rongeur up biting; 4×10 mm; 30 cm	516
116 91 0490	Spurling kleště zahnuté dolů; 4×10 mm; 30 cm	Spurling rongeur down biting; 4×10 mm; 30 cm	516
116 91 0491	Selverstone kleště na ploténky; 2×3 mm; 15 cm	Selverstone rongeur; 2×3 mm	517
116 91 0492	Selverstone kleště na ploténky; 2×5 mm; 15 cm	Selverstone rongeur; 2×5 mm	517
116 91 0493	Schlesinger kleště na ploténky; 2×10 mm; 15 cm	Schlesinger rongeur; 2×10 mm	517
116 91 0494	Schlesinger kleště na ploténky; 3×10 mm; 15 cm	Schlesinger rongeur; 3×10 mm	517
116 91 0495	Schlesinger kleště na ploténky; 4×10 mm; 15 cm	Schlesinger rongeur; 4×10 mm	517
116 91 0496	Caspar kleště na ploténky; 2×10 mm; 15 cm	Caspar rongeur; 2×10 mm; 15 cm	517
116 91 0497	Caspar kleště na ploténky; 3×10 mm; 15 cm	Caspar rongeur; 3×10 mm; 15 cm	517
116 91 0498	Caspar kleště na ploténky; 4×10 mm; 15 cm	Caspar rongeur; 4×10 mm; 15 cm	517
116 91 0499	Cloward kleště rovné; 6×10 mm; 15 cm	Cloward rongeur straight; 6×10 mm; 15 cm	518
116 91 0500	Cloward kleště zahnuté nahoru; 6×10 mm; 15 cm	Cloward rongeur curved up; 6×10 mm; 15 cm	518
116 91 0501	Cloward kleště zahnuté dolů; 6×10 mm; 15 cm	Cloward rongeur curved down; 6×10 mm; 15,0 cm	518
116 91 0502	Ferris-Smith štípek rovný; 2×10 mm; 18 cm	Ferris-Smith rongeur straight; 2×10 mm; 18 cm	519
116 91 0503	Ferris-Smith štípek zahnutý nahoru; 2×10 mm; 18 cm	Ferris-Smith rongeur up biting; 2×10 mm; 18 cm	519
116 91 0504	Ferris-Smith štípek zahnutý dolů; 2×10 mm; 18 cm	Ferris-Smith rongeur down biting; 2×10 mm; 18 cm	519
116 91 0505	Ferris-Smith štípek rovný; 3×10 mm; 18 cm	Ferris-Smith rongeur straight; 3×10 mm; 18 cm	519

číslo – number	název	item	strana – page
116 91 0506	Ferris-Smith štípák zahnutý nahoru; 3×10 mm; 18 cm	Ferris-Smith rongeur up bitin; 3×10 mm; 18 cm	519
116 91 0507	Ferris-Smith štípák zahnutý dolů; 3×10 mm; 18 cm	Ferris-Smith rongeur down bitin; 3×10 mm; 18 cm	519
116 91 0508	Ferris-Smith štípák rovný; 4×10 mm; 18 cm	Ferris-Smith rongeur straight; 4×10 mm; 18 cm	519
116 91 0509	Ferris-Smith štípák zahnutý nahoru; 4×10 mm; 18 cm	Ferris-Smith rongeur up bitin; 4×10 mm; 18 cm	519
116 91 0510	Ferris-Smith štípák zahnutý dolů; 4×10 mm; 18 cm	Ferris-Smith rongeur down bitin; 4×10 mm; 18 cm	519
116 91 0511	Ferris-Smith štípák rovný; 6×12 mm; 18 cm	Ferris-Smith rongeur straight; 6×12 mm; 18 cm	519
116 91 0512	Ferris-Smith štípák zahnutý nahoru; 6×12 mm; 18 cm	Ferris-Smith rongeur up bitin; 6×12 mm; 18 cm	519
116 91 0513	Ferris-Smith štípák zahnutý dolů; 6×12 mm; 18 cm	Ferris-Smith rongeur down bitin; 6×12 mm; 18 cm	519
116 91 0514	Friedman kleště štípací na kosti; 14,0 cm	Friedman bone rongeur; 14.0 cm	173
116 91 0515	Stellbrink kleště štípací na kosti; 17,0 cm	Stellbrink bone rongeur; 17.0 cm	173
116 91 0516	Stellbrink kleště štípací na kosti; 17,0 cm	Stellbrink bone rongeur; 17.0 cm	173
116 91 0518	Cleveland kleště štípací na kosti; 17,0 cm	Cleveland bone rongeur; 17.0 cm	173
116 91 0522	Blumenthal kleště štípací na kosti; 15,5 cm	Blumenthal bone rongeur; 15.5 cm	173
116 91 0523	Blumenthal kleště štípací na kosti; 15,5 cm	Blumenthal bone rongeur; 15.5 cm	173
116 91 0524	Blumenthal kleště štípací na kosti; 15,5 cm	Blumenthal bone rongeur; 15.5 cm	173
116 91 0527	Luer kleště štípací na kosti; 15,0 cm	Luer bone rongeur; 15.0 cm	173
116 91 0528	Luer kleště štípací na kosti; 15,0 cm	Luer bone rongeur; 15.0 cm	173
116 91 0529	Luer kleště štípací na kosti; 15,0 cm	Luer bone rongeur; 15.0 cm	173
116 91 0538	Oldberg štípák na laminektomii rovné; 6 mm; 18 cm	Oldberg rongeur forceps; 7 mm; 18 cm	518
116 91 0539	Hercules kleště štípací na drát; 23,0 cm	Hercules wire cutting forceps; 23.0 cm	186
116 91 0540	Sada gumových čelistí pro štípací kleště Hercules	Set of rubber jaws for forceps Hercules	186
116 91 0541	Sada čelistí pro štípací kleště Hercules	Set of jaws for forceps Hercules	186
116 91 0542	Tischler-Kevorkian kleště na biopsii; 22,0 cm	Tischler-Kevorkian biopsy forceps; 22.0 cm	448
116 91 0543	Kevorkian-Pacific kleště na biopsii; 22,0 cm	Kevorkian-Pacific biopsy forceps; 22.0 cm	448
116 91 0544	Baby-Tischler kleště na biopsii; 20,0 cm	Baby-Tischler biopsy forceps; 20.0 cm	449
116 91 0545	Burke kleště na biopsii; 22,0 cm	Burke cervical biopsy forceps; 22.0 cm	448
116 91 0546	Berger kleště na biopsii; 20,5 cm	Berger biopsy forceps; 20.5 cm	454
116 91 0548	Kleště na žebra srpovitě; 22 cm	Rib Forceps curved; 22 cm	182
116 91 0549	Bethune kleště na žebra; 34 cm	Bethune rib forceps; 34 cm	182
116 91 0550	Sauerbruch kleště na žebra; 26 cm	Sauerbruch rib forceps; 26 cm	182
116 91 0551	Coryllos kleště na žebra levé; 35 cm	Coryllos rib forceps left; 35 cm	182
116 91 0552	Coryllos kleště na žebra pravé; 35 cm	Coryllos rib forceps right; 35 cm	182
116 91 0553	Sauerbruch-Frey kleště na žebra; 36 cm	Sauerbruch-Frey forceps for ribs; 36 cm	183
116 91 0555	Brunner kleště na žebra pro pravou ruku; 28 cm	Brunner rib forceps for right hand; 28 cm	183
116 91 0556	Brunner kleště na žebra pro levou ruku; 28 cm	Brunner rib forceps for left hand; 28 cm	183
116 91 0561	De Vilbiss kleště kranialní; 21 cm	De Vilbiss cranial rongeur forceps; 21 cm	523
116 91 0562	Dahlgreen kleště kranialní; 20 cm	Dahlgreen cranial rongeur forceps; 20 cm	523
116 91 0563	Bellucci nástroj mikro; 8,0 cm	Bellucci micro instrument; 8.0 cm	524
116 91 0564	Bellucci nástroj mikro; 8,0 cm	Bellucci micro instrument; 8.0 cm	524
116 91 0565	Bellucci nástroj mikro; 8,0 cm	Bellucci micro instrument; 8.0 cm	524
116 91 0566	Fahlbusch nástroj mikro; 16,5 cm	Fahlbusch micro instrument; 16.5 cm	524
116 91 0567	Nicola nástroj mikro rovný; 2 mm; 20 cm	Nicola micro instrument straight; 2 mm; 20 cm	525
116 91 0568	Nicola nástroj mikro rovný; 2 mm; 20 cm	Nicola micro instrument straight; 2 mm; 20 cm	525
116 91 0569	Nicola nástroj mikro rovný; 2 mm; 20 cm	Nicola micro instrument straight; 2 mm; 20 cm	525
116 91 0570	Nicola nástroj mikro rovný; 2 mm; 20 cm	Nicola micro instrument straight; 2 mm; 20 cm	525
116 91 0571	Nicola nástroj mikro rovný; 2 mm; 20 cm	Nicola micro instrument straight; 2 mm; 20 cm	525
116 91 0572	Nicola nástroj mikro rovný; 2 mm; 20 cm	Nicola micro instrument straight; 2 mm; 20 cm	525
116 91 0573	Nicola nástroj mikro rovný; 2 mm; 20 cm	Nicola micro instrument straight; 2 mm; 20 cm	525
116 91 0574	Nicola nástroj mikro rovný; 2 mm; 20 cm	Nicola micro instrument straight; 2 mm; 20 cm	525
116 91 0575	Nástroj mikro; 3 mm; 14,0 cm	Micro instrument; 3 mm; 14.0 cm	525
116 91 0576	Nástroj mikro; 7 mm; 14,0 cm	Micro instrument; 7 mm; 14.0 cm	525
116 91 0577	Nástroj mikro; 9 mm; 14,0 cm	Micro instrument; 9 mm; 14.0 cm	525
116 91 0578	Nástroj mikro; 12 mm; 14,0 cm	Micro instrument; 12 mm; 14.0 cm	525
116 91 0579	Nástroj mikro; 3 mm; 18,0 cm	Micro instrument; 3 mm; 18.0 cm	525
116 91 0580	Nástroj mikro; 7 mm; 18,0 cm	Micro instrument; 7 mm; 18.0 cm	525
116 91 0581	Nástroj mikro; 9 mm; 18,0 cm	Micro instrument; 9 mm; 18.0 cm	525
116 91 0582	Nástroj mikro; 12 mm; 18,0 cm	Micro instrument; 12 mm; 18.0 cm	525
116 91 0583	Ferris-Smith štípák; 5×5 mm; 18 cm	Ferris-Smith laminectomy punch up; 5×5 mm; 18 cm	519
116 91 0584	Ferris-Smith štípák; 5×5 mm; 18 cm	Ferris-Smith laminectomy punch down; 5×5 mm; 18 cm	519
116 91 0585	Hajak-Koffler štípák na ploténky; 4×4 mm; 14 cm	Hajak-Koffler laminectomy punches up; 4×4 mm; 14 cm	520
116 91 0586	Hajak-Koffler štípák na ploténky; 4×4 mm; 14 cm	Hajak-Koffler laminectomy punches down; 4×4mm; 14 cm	520
116 91 0587	Hajak-Koffler štípák na ploténky; 3,5×3,5 mm; 14 cm	Hajak-Koffler punches up; 3.5×3.5 mm; 14 cm	520
116 91 0588	Hajak-Koffler štípák na ploténky; 3,5×3,5 mm; 14 cm	Hajak-Koffler punches down; 3.5×3.5 mm; 14 cm	520
116 91 0589	Hajak-Koffler štípák na ploténky; 16,0 cm	Hajak-Koffler laminectomy punches; 16.0 cm	520
116 91 0590	Kerrison štípák na ploténky; 3×3 mm; 9 cm	Kerrison laminectomy punches; 3×3 mm; 9 cm	521
116 91 0591	Kerrison štípák na ploténky 4×4 mm; 9 cm	Kerrison laminectomy punches; 4×4 mm; 9 cm	521
116 91 0592	Kerrison štípák na ploténky; 5×5 mm; 9 cm	Kerrison laminectomy punches; 5×5 mm; 9 cm	521
116 91 0593	Kerrison štípák na ploténky 6×6 mm; 9 cm	Kerrison laminectomy punches; 6×6 mm; 9 cm	521
116 91 0594	Plattfuss štípák na ploténky; 1 mm; 18 cm	Plattfuss laminectomy punches up; 1 mm; 18 cm	521
116 91 0595	Plattfuss štípák na ploténky; 2 mm; 18 cm	Plattfuss laminectomy punches up; 2 mm; 18 cm	521
116 91 0596	Plattfuss štípák na ploténky; 3 mm; 18 cm	Plattfuss laminectomy punches up; 3 mm; 18 cm	521
116 91 0597	Plattfuss štípák na ploténky; 4 mm; 18 cm	Plattfuss laminectomy punches up; 4 mm; 18 cm	521
116 91 0598	Plattfuss štípák na ploténky; 2 mm; 18 cm	Plattfuss laminectomy punches down; 2 mm; 18 cm	521
116 91 0599	Plattfuss štípák na ploténky; 3 mm; 18 cm	Plattfuss laminectomy punches down; 3 mm; 18 cm	521
116 91 0600	Landolt nástroj pituitární; 2,2 mm; 19 cm	Landolt pituitary instrument; 2.2 mm; 19 cm	522
116 91 0601	Nástroj pituitární; 3,5 mm; 19 cm	Pituitary instrument; 3.5 mm; 19 cm	522
116 91 0602	Landolt nástroj pituitární; 9 mm; 20,0 cm	Landolt pituitary instrument; 9 mm; 20 cm	522
117 07 0040	Kleště na hadici; 15,0 cm	Tubing forceps; 15.0 cm	170
117 08 0020	Kleště na kostní úlomky; 20,0 cm	Sequestrum forceps; 20.0 cm	191
117 08 0040	Fergusson kleště na držení kosti; 21,0 cm	Fergusson bone holding forceps; 21.0 cm	191
117 09 0260	Bartl kleště na vytažení kostních prutů; 21,5 cm	Bartl nail extraction forceps; 21.5 cm	191
117 09 0270	Bartl kleště na vytažení kostních prutů jemné; 21,5 cm	Bartl nail extraction forceps; 21.5 cm	191
117 14 0110	Duval kleště na plíce okénkované; 16 mm; 22,0 cm	Duval lung grasping forceps; 16 mm; 22.0 cm	196
117 14 0120	Duval kleště na plíce okénkované; 21 mm; 22,0 cm	Duval lung grasping forceps; 21 mm; 22.0 cm	196

číslo – number	název	item	strana – page
117 14 0130	Duval kleště na plíce okénkované; 26 mm; 22,0 cm	Duval lung grasping forceps; 26 mm; 22.0 cm	196
117 19 0020	Kleště na hemoroidy; 20,0 cm	Haemorrhoids forceps; 20.0 cm	197
117 19 0070	Allis kleště na střeva; 21,0 cm	Allis intestinal forceps; 21.0 cm	197
117 22 0160	Collin kleště na výrůstky; 18,0 mm; 24,5 cm	Collin tumor forceps; 18.0 mm; 24.5 cm	197
117 22 0270	Randall kleště na ledvinové kameny fig.1; 23,0 cm	Randall kidney stone forceps fig.1; 23.0 cm	198
117 22 0280	Randall kleště na ledvinové kameny fig.2; 23,0 cm	Randall kidney stone forceps fig.2; 23.0 cm	198
117 22 0290	Randall kleště na ledvinové kameny fig.3; 23,0 cm	Randall kidney stone forceps fig.3; 23.0 cm	198
117 27 0010	Schröder kleště jednoháčkové; 25,0 cm	Schröder gynaecological forceps; 25.0 cm	456
117 27 0020	Schröder kleště dvouháčkové; 24,0 cm	Schröder gynaecological forceps; 24.0 cm	457
117 27 0150	Kepák kleště na cervix; 26,0 cm	Kepák gynaecological forceps; 26.0 cm	458
117 27 0260	Gross-Maier kleště tamponové rovné s uzávěrem; 25,0 cm	Gross-Maier sponge holding forceps; 25.0 cm	202
117 27 0270	Kleště tamponové rovné bez uzávěru; 26,5 cm	Sponge holding forceps; 26.5 cm	202
117 27 0280	Gross-Maier kleště tamponové zahnuté s uzávěrem; 25,0 cm	Gross-Maier sponge holding forceps; 25.0 cm	202
117 27 0290	Kleště tamponové zahnuté bez uzávěru; 26,5 cm	Sponge holding forceps; 26.5 cm	202
117 27 0510	Bozemann kleště tamponové; 26,0 cm	Bozemann sponge holding forceps; 26.0 cm	200
117 29 0060	Kleště ušní úchopné jemné; 0,6x0,9x3,5 mm; 6,8 cm	Ear forceps; 0.6x0.9x3.5 mm; 6.8 cm	388
117 29 0070	Kleště ušní úchopné jemné; 0,6x0,9x5,5 mm; 7,0 cm	Ear forceps; 0.6x0.9x5.5 mm; 7.0 cm	388
117 31 0010	Collin kleště na jazyk okénkované; 16,0 cm	Collin tongue holding forceps; 16.0 cm	393
117 31 0030	Löbker kleště na jazyk jednoháčkové; 16,5 cm	Löbker tongue holding forceps; 16.5 cm	393
117 50 0620	Schwartz aplikátor svorek micro-bulldog; 22,0 cm	Schwartz micro-bulldog forceps; 22.0 cm	98
117 91 0001	Lister kleště tamponové; 13,0 cm	Lister sinus forceps; 13.0 cm	199
117 91 0002	Lister kleště tamponové; 16,0 cm	Lister sinus forceps; 16.0 cm	199
117 91 0003	Lister kleště tamponové; 18,0 cm	Lister sinus forceps; 18.0 cm	199
117 91 0004	Ulrich kleště na polypy rovné; 22,0 cm	Ulrich polypus forceps straight; 22.0 cm	199
117 91 0005	Ulrich kleště na polypy rovné; 25,0 cm	Ulrich polypus forceps straight; 25.0 cm	199
117 91 0007	Ulrich kleště na polypy zahnuté; 22,0 cm	Ulrich polypus forceps curved; 22.0 cm	199
117 91 0008	Ulrich kleště na polypy zahnuté; 25,0 cm	Ulrich polypus forceps curved; 25.0 cm	199
117 91 0033	Collin kleště tamponové; 24,0 cm	Collin dressing forceps; 24.0 cm	200
117 91 0034	Notto kleště na polypy; 27,5 cm	Notto polypus forceps; 27.5 cm	200
117 91 0035	Pelkmann kleště tamponové rovné; 25,0 cm	Pelkmann dressing forceps straight; 25.0 cm	201
117 91 0037	Kelly kleště na polypy; 32,0 cm	Kelly polypus forceps; 32.0 cm	201
117 91 0038	Heywood-Smith kleště tamponové; 21,0 cm	Heywood-Smith forceps; 21.0 cm	201; 433; 434
117 91 0039	Heywood-Smith kleště tamponové; 25,0 cm	Heywood-Smith forceps screw; 25.0 cm	201
117 91 0042	Foerster-Ballenger kleště tamponové rovné vroubk.; 18,0 cm	Foerster-Ballenger forceps straight serrated; 18.0 cm	203; 435
117 91 0043	Foerster-Ballenger kleště tamponové rovné vroubk.; 20,0 cm	Foerster-Ballenger forceps straight serrated; 20.0 cm	203; 434
117 91 0044	Foerster-Ballenger kleště tamponové rovné vroubk.; 25,0 cm	Foerster-Ballenger forceps straight serrated; 25.0 cm	203
117 91 0045	Foerster-Ballenger kleště tamponové zah. vroubk.; 18,0 cm	Foerster-Ballenger forceps curved serrated; 18.0 cm	203; 435
117 91 0046	Foerster-Ballenger kleště tamponové zah. vroubk.; 20,0 cm	Foerster-Ballenger forceps curved serrated; 20.0 cm	203; 434
117 91 0047	Foerster-Ballenger kleště tamponové zah. vroubk.; 25,0 cm	Foerster-Ballenger forceps curved serrated; 25.0 cm	203
117 91 0048	Foerster-Ballenger kleště tamponové rovné hladké; 18,0 cm	Foerster-Ballenger forceps straight smooth; 18.0 cm	203
117 91 0049	Foerster-Ballenger kleště tamponové rovné hladké; 20,0 cm	Foerster-Ballenger forceps straight smooth; 20.0 cm	203
117 91 0050	Foerster-Ballenger kleště tamponové rovné hladké; 25,0 cm	Foerster-Ballenger forceps straight smooth; 25.0 cm	203
117 91 0051	Foerster-Ballenger kleště tamponové zah. hladké; 18,0 cm	Foerster-Ballenger forceps curved smooth; 18.0 cm	203
117 91 0052	Foerster-Ballenger kleště tamponové zah. hladké; 20,0 cm	Foerster-Ballenger forceps curved smooth; 20.0 cm	203
117 91 0053	Foerster-Ballenger kleště tamponové zah. hladké; 25,0 cm	Foerster-Ballenger forceps curved smooth; 25.0 cm	203
117 91 0054	Foerster kleště tamponové úzké rovné; 25,0 cm	Foerster sponge holding forceps straight; 25.0 cm	204
117 91 0055	Foerster kleště tamponové úzké zahnuté; 25,0 cm	Foerster sponge holding forceps curved; 25.0 cm	204
117 91 0056	Rampléy kleště tamponové; 25,0 cm	Rampléy sponge holding forceps; 25.0 cm	204
117 91 0063	Henning kleště na sádrové obvazy; 28,0 cm	Henning plaster cast spreader; 28.0 cm	189
117 91 0064	Beeson kleště na sádrové obvazy; 30,0 cm	Beeson plaster cast spreader; 30.0 cm	189
117 91 0066	Wolff kleště na sádrové obvazy; 18,0 cm	Wolff plaster cast forceps; 18.0 cm	189
117 91 0067	Wolff kleště na sádrové obvazy; 24,0 cm	Wolff plaster cast forceps; 24.0 cm	189
117 91 0069	Stille kleště na sádrové obvazy; 23,0 cm	Stille plaster of paris shears; 23.0 cm	189
117 91 0070	Stille kleště na sádrové obvazy; 26,0 cm	Stille plaster of paris shears; 26.0 cm	189
117 91 0071	Stille kleště na sádrové obvazy; 37,0 cm	Stille plaster of paris shears; 37.0 cm	189
117 91 0072	Magill kleště na zavádění endotracheálních rourek; 16,0 cm	Magill catheter introducing forceps; 16.0 cm	190
117 91 0073	Magill kleště na zavádění endotracheálních rourek; 20,0 cm	Magill catheter introducing forceps; 20.0 cm	190
117 91 0074	Magill kleště na zavádění endotracheálních rourek; 25,0 cm	Magill catheter introducing forceps; 25.0 cm	190
117 91 0077	Dartigues kleště děložní; 27,0 cm	Dartigues uterine elevating forceps; 27.0 cm	460
117 91 0078	Somer kleště děložní zahnuté; 23,0 cm	Somer uterine elevating forceps; 23.0 cm	460
117 91 0080	Kleště úchopné na drát; 17,0 mm	Wire grasping forceps; 17.0 mm	190
117 91 0081	Kleště úchopné na drát; 17,0 mm	Wire grasping forceps; 17.0 mm	190
117 91 0082	Kleště úchopné na drát; 15,0 mm	Wire grasping forceps; 15.0 mm	190
117 91 0117	Farabeuf-Lambotte kleště repositionční; 26,0 cm	Farabeuf-Lambotte reposition forceps; 26.0 cm	194
117 91 0118	Farabeuf kleště repositionční; 23,0 cm	Farabeuf reposition forceps; 23.0 cm	194
117 91 0119	Farabeuf kleště repositionční; 26,0 cm	Farabeuf reposition forceps; 26.0 cm	194
117 91 0120	Verbrugge kleště repositionční; 17,5 cm	Verbrugge reposition forceps; 17.5 cm	195
117 91 0121	Verbrugge kleště repositionční; 25,0 cm	Verbrugge reposition forceps; 25.0 cm	195
117 91 0122	Verbrugge kleště repositionční; 26,0 cm	Verbrugge reposition forceps; 26.0 cm	195
117 91 0123	Verbrugge kleště repositionční; 27,0 cm	Verbrugge reposition forceps; 27.0 cm	195
117 91 0133	Kleště repositionční; 15,0 cm	Reposition forceps; 15.0 cm	193
117 91 0134	Kleště repositionční; 19,0 cm	Reposition forceps; 19.0 cm	193
117 91 0135	Kleště repositionční; 24,0 cm	Reposition forceps; 24.0 cm	193
117 91 0136	Kleště repositionční; 26,0 cm	Reposition forceps; 26.0 cm	193
117 91 0137	Kleště repositionční; 28,0 cm	Reposition forceps; 28.0 cm	193
117 91 0153	Nástroj pro přenos IUD	Instrument for removal of I.U.D	465
117 91 0154	Naegele kleště porodní; 36,0 cm	Naegele perforator; 36.0 cm	462
117 91 0155	Naegele kleště porodní; 40,0 cm	Naegele perforator; 40.0 cm	462
117 91 0156	Simpson kleště porodní; 23,0 cm	Simpson obstetrical forceps; 23.0 cm	463
117 91 0157	Simpson kleště porodní; 30,0 cm	Simpson obstetrical forceps; 30.0 cm	463
117 91 0158	Simpson-Braun kleště porodní; 36,0 cm	Simpson-Braun obstetrical forceps; 36.0 cm	463
117 91 0159	McLean kleště porodní; 36,0 cm	McLean obstetrical forceps; 36.0 cm	463
117 91 0160	Kielland kleště porodní; 41,0 cm	Kielland forceps; 41.0 cm	463
117 91 0161	Kielland-Luikart kleště porodní; 40,0 cm	Kielland-Luikart forceps; 40.0 cm	463



číslo – number	název	item	strana – page
117 91 0162	Wrigley kleště porodní; 28,0 cm	Wrigley obstetrical forceps; 28.0 cm	462
117 91 0163	De Lee kleště porodní; 30,0 cm	De Lee obstetrical forceps; 30.0 cm	462
117 91 0164	Piper kleště porodní; 44,0 cm	Piper obstetrical forceps; 44.0 cm	462
117 91 0165	Winter kleště potratové rovné fig. 1; 28,0 cm	Winter abortion forceps fig. 1; 28.0 cm	461
117 91 0166	Winter kleště potratové rovné fig. 2; 28,0 cm	Winter abortion forceps fig. 2; 28.0 cm	461
117 91 0167	Winter kleště potratové zahnuté fig. 1; 28,0 cm	Winter abortion forceps fig. 1; 28.0 cm	461
117 91 0168	Saenger kleště děložní rovné; 27,0 cm	Saenger ovum forceps; 27.0 cm	460
117 91 0169	Saenger kleště děložní zahnuté; 27,0 cm	Saenger ovum forceps; 27.0 cm	460
117 91 0170	Green-Armytage kleště; 22,0 cm	Green-Armytage forceps; 22.0 cm	462
117 91 0171	Naegele perforátor; 25,0 cm	Naegele perforator; 25.0 cm	465
117 91 0172	Smellie perforátor; 25,0 cm	Smellie perforator; 25.0 cm	465
117 91 0173	Tarnier basiotribe; 46,0 cm	Tarnier basiotribe; 46.0 cm	464
117 91 0174	Braun cranioclast; 42,0 cm	Braun cranioclast; 42.0 cm	464
117 91 0175	Iowa kleště děložní; 26,0 cm	Iowa tenaculum forceps; 26.0 cm	460
117 91 0176	Winter kleště potratové zahnuté fig. 2; 28,0 cm	Winter abortion forceps fig. 2; 28.0 cm	461
117 91 0177	Young kleště na jazyk; 17,0 cm	Young tongue forceps; 17.0 cm	393
117 91 0178	Koncovky gumové pro kleště Young - pár	Rubber end-pieces only for forceps Young	393
117 91 0179	Lahey kleště úchopné; 15,0 cm	Lahey ear forceps; 15.0 cm	388
117 91 0180	Lahey kleště úchopné; 20,0 cm	Lahey ear forceps; 20.0 cm	388
117 91 0181	Fraenkel kleště na polypy; 18,0 cm	Fraenkel polypus forceps; 18.0 cm	391
117 91 0184	Hartmann-Wullstein kleště na polypy; 8,5 cm	Hartmann-Wullstein polypus forceps; 8.5 cm	390
117 91 0185	Hartmann-Wullstein kleště miskové; 8,5 cm	Hartmann-Wullstein polypus forceps; 8.5 cm	390
117 91 0186	Hartmann kleště na polypy; 8,5 cm	Hartmann polypus forceps; 8.5 cm	390
117 91 0187	Hartmann kleště na polypy; 14,0 cm	Hartmann polypus forceps; 14.0 cm	390
117 91 0188	Hartmann kleště na polypy; 1x2 zuby; 8,5 cm	Hartmann polypus forceps; 1x2 teeth; 8.5 cm	390
117 91 0189	Hartmann kleště na polypy; 1x2 zuby; 14,0 cm	Hartmann polypus forceps; 1x2 teeth; 14.0 cm	390
117 91 0190	Hartmann-Noyes kleště ušní; 8,5 cm	Hartmann-Noyes ear forceps; 8.5 cm	390
117 91 0191	Duckbill kleště ušní; 8,5 cm	Duckbill ear forceps; 8.5 cm	390
117 91 0192	Weingärtner kleště ušní; 8,5 cm	Weingärtner ear forceps; 8.5 cm	390
117 91 0198	Kleště mikro laryngeální rovné; 2,0 mm; 25,0 cm	Laryngeal micro forceps straight; 2.0 mm; 25.0 cm	393
117 91 0199	Kleště mikro laryngeální zahnuté; 2,0 mm; 25,0 cm	Laryngeal micro forceps curved; 2.0 mm; 25.0 cm	393
117 91 0200	Kleště mikro laryngeální zahnuté; 2,0 mm; 25,0 cm	Laryngeal micro forceps curved; 2.0 mm; 25.0 cm	393
117 91 0201	Pozzi kleště gynekologické; 25,0 cm	Pozzi gynaecological forceps; 25.0 cm	456
117 91 0202	Barrett kleště gynekologické; 18,0 cm	Barrett gynaecological forceps; 18.0 cm; 23.0 cm	456
117 91 0203	Saigres kleště gynekologické; 4,5 mm; 23,0 cm	Saigres gynaecological forceps; 4.5 mm; 24.0 cm	458
117 91 0204	Museux kleště gynekologické rovné; 6 mm; 24,0 cm	Museux gynaecological forceps; 6 mm; 24.0 cm	459
117 91 0205	Museux kleště gynekologické rovné; 8 mm; 24,0 cm	Museux gynaecological forceps; 8 mm; 24.0 cm	459
117 91 0206	Museux kleště gynekologické rovné; 10 mm; 24,0 cm	Museux gynaecological forceps; 10 mm; 24.0 cm	459
117 91 0207	Museux kleště gynekologické zahnuté; 6 mm; 24,0 cm	Museux gynaecological forceps; 6 mm; 24.0 cm	459
117 91 0208	Museux kleště gynekologické zahnuté; 8 mm; 24,0 cm	Museux gynaecological forceps; 8 mm; 24.0 cm	459
117 91 0209	Museux kleště gynekologické zahnuté; 10 mm; 24,0 cm	Museux gynaecological forceps; 10 mm; 24.0 cm	459
117 91 0210	Schröder kleště gynekologické; 24,0 cm	Schröder gynaecological forceps; 24.0 cm	457
117 91 0211	Pratt kleště gynekologické; 28,0 cm	Pratt gynaecological forceps; 28.0 cm	457
117 91 0212	Jacobs kleště gynekologické rovné; 21,0 mm	Jacobs gynaecological forceps; 21.0 mm	459
117 91 0213	Jacobs kleště gynekologické zahnuté; 21,0 mm	Jacobs gynaecological forceps; 21.0 mm	459
117 91 0214	Teale kleště gynekologické zahnuté; 23,0 mm	Teale gynaecological forceps; 23.0 mm	459
117 91 0215	Hartmann kleště nosní na polypy; 16,0 cm	Hartmann nasal polypus forceps; 16.0 cm	391
117 91 0216	Hartmann kleště nosní na polypy; 20,0 cm	Hartmann nasal polypus forceps; 20.0 cm	391; 432; 433
117 91 0217	Heymann-Knight kleště nosní na polypy; 18,0 cm	Heymann-Knight nasal polypus forceps; 18.0 cm	391
117 91 0218	Lubet-Barbon kleště nosní na polypy; 20,0 cm	Lubet-Barbon nasal polypus forceps; 20.0 cm	391
117 91 0219	Kilian kleště nosní na polypy; 17,0 cm	Kilian nasal polypus forceps; 17.0 cm	391
117 91 0220	Westmacott kleště nosní na polypy fig.1; 20,0 cm	Westmacott nasal polypus forceps fig.1; 20.0 cm	391
117 91 0221	Westmacott kleště nosní na polypy fig.2; 20,0 cm	Westmacott nasal polypus forceps fig.2; 20.0 cm	391
117 91 0222	Asch kleště na rovnání přepážky zahnuté; 23,0 cm	Asch septum straightening forceps; 23.0 cm	392
117 91 0228	Kressner kleště na přepážku; 2,5x60 mm; 20,0 cm	Kressner septum forceps; 2.5x60 mm; 20.0 cm	392
117 91 0229	Kressner kleště na přepážku; 4x70 mm; 20,0 cm	Kressner septum forceps; 4x70 mm; 20.0 cm	392
117 91 0230	Kressner kleště na přepážku; 5x75 mm; 20,0 cm	Kressner septum forceps; 5x75 mm; 20.0 cm	392
117 91 0231	Kleště ušní úchopné rovné; 4,5x0,8 mm; 8,0 cm	Ear forceps straight; 4.5x0.8 mm; 8.0 cm	389
117 91 0232	Kleště ušní úchopné rovné hladké; 4,5x0,8 mm; 8,0 cm	Ear forceps straight smooth; 4.5x0.8 mm; 8.0 cm	389
117 91 0233	Kleště ušní úchopné zahnuté vlevo; 4,5x0,8 mm; 8,0 cm	Ear forceps curved left; 4.5x0.8 mm; 8.0 cm	389
117 91 0234	Kleště ušní úchopné zahnuté vpravo; 4,5x0,8 mm; 8,0 cm	Ear forceps curved right; 4.5x0.8 mm; 8.0 cm	389
117 91 0235	Kleště ušní úchopné zahnuté nahoru; 4,5x0,8 mm; 8,0 cm	Ear forceps curved up; 4.5x0.8 mm; 8.0 cm	389
117 91 0236	Kleště ušní úchopné zahnuté dolů; 4,5x0,8 mm; 8,0 cm	Ear forceps curved down; 4.5x0.8 mm; 8.0 cm	389
117 91 0237	Kleště ušní úchopné; 8,5x0,8 mm; 8,0 cm	Ear forceps; 8.5x0.8 mm; 8.0 cm	389
117 91 0238	Kleště ušní úchopné; 8,5x1,8 mm; 8,0 cm	Ear forceps; 8.5x1.8 mm; 8.0 cm	389
117 91 0239	Kleště ušní úchopné; 4,0x0,6 mm; 8,0 cm	Ear forceps; 4.0x0.6 mm; 8.0 cm	389
117 91 0240	Kleště ušní úchopné hladké čelisti; 4,0x0,6 mm; 8,0 cm	Ear forceps smooth; 4.0x0.6 mm; 8.0 cm	389
117 91 0241	Wullstein kleště úchopné ušní; 8,5 cm	Wullstein ear forceps; 8.5 cm	388
117 91 0264	Kleště zaváděcí pro malé svorky; 16,0 cm	Applying forceps for small clips; 16.0 cm	526
117 91 0265	Kleště zaváděcí pro střední svorky; 16,0 cm	Applying forceps for medium clips; 16.0 cm	526
117 91 0266	Kleště zaváděcí pro středně velké svorky; 19,0 cm	Applying forceps for med-large clips; 19.0 cm	526
117 91 0267	Kleště zaváděcí pro malé svorky; 20,0 cm	Applying forceps for small clips; 20.0 cm	526
117 91 0268	Kleště zaváděcí pro střední svorky; 20,0 cm	Applying forceps for medium clips; 20.0 cm	526
117 91 0269	Kleště zaváděcí pro velké svorky; 20,0 cm	Applying forceps for large clips; 20.0 cm	526
117 91 0270	Svorka malá 12x25 ks (krabička)	Clip; small; box 12x25 clips	526
117 91 0271	Svorka malá 24x10 ks (krabička)	Clip; small; box 24x10 clips	526
117 91 0272	Svorka střední 10x25 ks (krabička)	Clip; medium; box 10x25 clips	526
117 91 0273	Svorka střední 20x10 ks (krabička)	Clip; medium; box 20x10 clips	526
117 91 0274	Svorka středně velká 16x10 ks (krabička)	Clip; medium-large; box 16x10 clips	526
117 91 0275	Svorka velká 10x15 ks (krabička)	Clip; large; box 10x15 clips	526
117 91 0276	Svorka velká 12x10 ks (krabička)	Clip; large; box 12x10 clips	526
117 91 0277	Mc Kenzie kleště zaváděcí zahnuté; 15,0 cm	Mc Kenzie brain clip applying forceps curved; 15.0 cm	527
117 91 0278	Mc Kenzie kleště zaváděcí zahnuté; 19,0 cm	Mc Kenzie brain clip applying forceps curved; 19.0 cm	527
117 91 0279	Mc Kenzie kleště zaváděcí rovné; 15,0 cm	Mc Kenzie brain clip applying forceps straight; 15.0 cm	527

číslo – number	název	item	strana – page
117 91 0280	Mc Kenzie kleště zaváděcí rovné; 19,0 cm	Mc Kenzie brain clip applying forceps straight; 19.0 cm	527
117 91 0281	Olivecrona-Toennis kleště zaváděcí; 14,0 cm	Olivecrona-Toennis applying forceps; 14.0 cm	527
117 91 0289	Winter kleště potratové rovné fig. 3; 28,0 cm	Winter abortion forceps fig. 3; 28.0 cm	461
117 91 0290	Winter kleště potratové rovné fig. 3; 28,0 cm	Winter abortion forceps fig. 3; 28.0 cm	461
117 99 0039	Kleště na držení kostí s kuličkou 6 mm; 23,5 cm	Bone forceps with ball 6 mm; 23.5 cm	192
117 99 0041	Kleště na držení kostí stavěcí; 25,0 cm	Bone forceps; 25.0 cm	192
117 99 0044	Kleště na držení kostí s kuličkou 6 mm; 23,5 cm	Bone forceps with ball 6 mm; 23.5 cm	192
118 08 0010	Hák jemný na rány jednozubý ostrý; 16,0 cm	Delicate hook 1 prong sharp; 16.0 cm	207
118 08 0020	Hák jemný na rány dvouzubý ostrý; 16,0 cm	Delicate hook 2 prongs sharp; 16.0 cm	207
118 08 0050	Hák jemný na rány jednozubý tupý; 16,0 cm	Delicate hook 1 prong blunt; 16.0 cm	207
118 08 0060	Hák jemný na rány dvouzubý tupý; 16,0 cm	Delicate hook 2 prongs blunt; 16.0 cm	207; 433
118 08 0310	Volkman hák na rány jednozubý ostrý fig.1; 21,5 cm	Volkman retractor 1 prong sharp fig.1; 21.5 cm	212
118 08 0320	Volkman hák na rány jednozubý ostrý fig.2; 21,5 cm	Volkman retractor 1 prong sharp fig.2; 21.5 cm	213
118 08 0330	Volkman hák na rány jednozubý tupý fig.3; 21,5 cm	Volkman retractor 1 prong blunt fig.3; 21.5 cm	212
118 08 0340	Volkman hák na rány jednozubý tupý fig.4; 21,5 cm	Volkman retractor 1 prong blunt fig.4; 21.5 cm	213
118 08 0350	Volkman hák na rány dvouzubý ostrý; 21,5 cm	Volkman retractor 2 prongs sharp; 21.5 cm	212
118 08 0360	Volkman hák na rány dvouzubý tupý; 21,5 cm	Volkman retractor 2 prongs blunt; 21.5 cm	212
118 08 0390	Volkman hák na rány čtyřzubý ostrý; 22,4 cm	Volkman retractor 4 prongs sharp; 22.4 cm	212
118 08 0400	Volkman hák na rány čtyřzubý tupý; 22,4 cm	Volkman retractor 4 prongs blunt; 22.4 cm	212
118 08 0410	Volkman hák na rány šestizubý ostrý; 22,0 cm	Volkman retractor 6 prongs sharp; 22.0 cm	212
118 08 0420	Volkman hák na rány šestizubý tupý; 22,0 cm	Volkman retractor 6 prongs blunt; 22.0 cm	212
118 08 0530	Israel hák na rány čtyřzubý tupý; 40x35 mm; 24,0 cm	Israel retractor 4 prongs blunt; 40x35 mm; 24.0 cm	214
118 08 0540	Israel hák na rány šestizubý tupý; 45x68 mm; 26,0 cm	Israel retractor 6 prongs blunt; 45x68 mm; 26.0 cm	214
118 08 0550	Kocher hák břišní plný; 80x42 mm; 25,0 cm	Kocher abdominal retractor; 80x42 mm; 25.0 cm	221
118 08 0560	Kocher hák břišní plný; 80x50 mm; 25,0 cm	Kocher abdominal retractor; 80x50 mm; 25.0 cm	221
118 08 0650	Middeldorpf hák na rány okénkóvy; 14x17 mm; 21,5 cm	Middeldorpf retractor; 14x17 mm; 21.5 cm	218
118 08 0660	Middeldorpf hák na rány okénkóvy; 20x22 mm; 22,0 cm	Middeldorpf retractor; 20x22 mm; 22.0 cm	218
118 08 0670	Middeldorpf hák na rány okénkóvy; 26x30 mm; 23,5 cm	Middeldorpf retractor; 26x30 mm; 23.5 cm	218
118 08 0680	Middeldorpf hák na rány okénkóvy; 62x50 mm; 28,0 cm	Middeldorpf retractor; 62x50 mm; 28.0 cm	218
118 08 0800	Langenbeck hák na rány; 30x16 mm; 21,0 cm	Langenbeck retractor; 30x16 mm; 21.0 cm	215
118 08 0810	Langenbeck hák na rány; 40x11 mm; 21,0 cm	Langenbeck retractor; 40x11 mm; 21.0 cm	215; 435
118 08 0840	Langenbeck hák na rány; 50x11 mm; 21,0 cm	Langenbeck retractor; 50x11 mm; 21.0 cm	215
118 08 1050	Kocher hák na rány ploché; 40x35 mm; 23,0 cm	Kocher abdominal retractor; 40x35 mm; 23.0 cm	216
118 08 1070	Kocher hák na rány ploché; 100x40 mm; 23,0 cm	Kocher abdominal retractor; 100x40 mm; 23.0 cm	216
118 08 1080	Hák břišní ploché; 120x30 mm; 24,0 cm	Abdominal retractor; 120x30 mm; 24.0 cm	220
118 08 1090	Hák břišní ploché; 140x50 mm; 24,5 cm	Abdominal retractor; 140x50 mm; 24.5 cm	220
118 08 1100	Mikulicz hák břišní prohnutý; 115x30 mm; 26,0 cm	Mikulicz abdominal retractor; 115x30 mm; 26.0 cm	224
118 08 1110	Mikulicz hák břišní prohnutý; 135x50 mm; 26,0 cm	Mikulicz abdominal retractor; 135x50 mm; 26.0 cm	224
118 08 1120	Fritsch hák břišní; 40x40 mm; 24,0 cm	Fritsch abdominal retractor; 40x40 mm; 24.0 cm	220
118 08 1130	Fritsch hák břišní; 50x80 mm; 27,0 cm	Fritsch abdominal retractor; 50x80 mm; 27.0 cm	220
118 12 0010	Hák jemný pro plastiku jednozubý ostrý fig.1; 16,0 cm	Plastic hook 1 prong sharp fig.1; 16.0 cm	225
118 12 0020	Hák jemný pro plastiku jednozubý ostrý fig.2; 16,0 cm	Plastic hook 1 prong sharp fig.2; 16.0 cm	225
118 12 0050	Hák jemný pro plastiku dvouzubý tupý; 5,0 mm; 16,0 cm	Plastic hook 2 prongs blunt; 5.0 mm; 16.0 cm	225
118 12 0060	Hák jemný pro plastiku dvouzubý ostrý; 5,0 mm; 16,0 cm	Plastic hook 2 prongs sharp; 5.0 mm; 16.0 cm	225
118 12 0070	Hák jemný pro plastiku čtyřzubý tupý; 12,0 mm; 16,0 cm	Plastic hook 4 prongs blunt; 12.0 mm; 16.0 cm	225
118 12 0080	Hák jemný pro plastiku čtyřzubý ostrý; 12,0 mm; 16,0 cm	Plastic hook 4 prongs sharp; 12.0 mm; 16.0 cm	225
118 12 0090	Hák na křídlo nosní oboustranný; 10,5 cm	Nasal alar hook; 10.5 cm	395; 433
118 17 0020	Hák jemný na nervy jednozubý ostrý; 15,5 cm	Nerve hook 1 prong sharp; 15.5 cm	532
118 28 0010	Smellie hák dekapitační a porodnický; 32,0 cm	Smellie decapitation hook; 32.0 cm	466
118 29 0010	Hartmann háček ušní jednozubý ostrý; 16,0 cm	Hartmann ear hook 1 prong sharp; 16.0 cm	394
118 29 0060	Schwartz hák ušní tupý pravouhle zahnutý; 17,0 cm	Schwartz ear hook blunt; 17.0 cm	394
118 31 0040	Hák resekcí čtyřzubý rovný; 16,4 cm	Resection hook 4 prongs straight; 16.4 cm	394
118 34 0020	Hák tracheální ploché; 19x11 mm; 23,5 cm	Tracheal hook; 19x11 mm; 23.5 cm	396; 435
118 34 0030	Hák tracheální dvakrát lomený; 16,5x5,0 mm; 21,0 cm	Tracheal hook; 16.5x5.0 mm; 21.0 cm	396
118 38 0010	Desmarres držátko víček; 10,0 mm; 13,0 cm	Desmarres delicate hook; 10.0 mm; 13.0 cm	209
118 38 0020	Desmarres držátko víček; 12,0 mm; 13,0 cm	Desmarres delicate hook; 12.0 mm; 13.0 cm	209
118 38 0030	Desmarres držátko víček; 14,0 mm; 13,0 cm	Desmarres delicate hook; 14.0 mm; 13.0 cm	209
118 38 0050	Graefe hák jemný na duhovku ostrý; 13,0 cm	Graefe iris hook sharp; 13.0 cm	210
118 38 0060	Graefe hák jemný na duhovku tupý; 14,0 cm	Graefe iris hook blunt; 14.0 cm	210
118 38 0210	Hák jemný oční dvouzubý ostrý; 2,6 mm; 13,5 cm	Eye hook 2 prongs sharp; 2.6 mm; 13.5 cm	210
118 38 0220	Hák jemný oční dvouzubý ostrý; 3,2 mm; 13,5 cm	Eye hook 2 prongs sharp; 3.2 mm; 13.5 cm	210; 433
118 38 0230	Hák jemný oční dvouzubý ostrý; 4,0 mm; 13,5 cm	Eye hook 2 prongs sharp; 4.0 mm; 13.5 cm	210
118 38 0360	Hák jemný oční čtyřzubý ostrý; 5,0 mm; 14,5 cm	Eye hook 4 prongs sharp; 5.0 mm; 14.5 cm	210
118 38 0370	Hák jemný oční čtyřzubý ostrý; 10,0 mm; 15,0 cm	Eye hook 4 prongs sharp; 10.0 mm; 15.0 cm	210
118 38 0420	Graefe hák jemný na operaci šilhání; 9,0 mm; 14,5 cm	Graefe strabismus hook; 9.0 mm; 14.5 cm	210
118 38 0460	Jaeger hák jemný na operaci šilhání; 14,5 cm	Jaeger strabismus hook; 14.5 cm	210
118 91 0008	Hák jemný fig.1; 16,0 cm	Delicate hook fig.1; 16.0 cm	208
118 91 0009	Hák jemný fig.2; 16,0 cm	Delicate hook fig.2; 16.0 cm	208
118 91 0010	Hák jemný fig.3; 16,0 cm	Delicate hook fig.3; 16.0 cm	208
118 91 0011	Hák jemný fig.4; 16,0 cm	Delicate hook fig.4; 16.0 cm	208
118 91 0013	Graefe hák jemný ostrý; 16,0 cm	Graefe delicate hook sharp; 16.0 cm	208
118 91 0014	Graefe hák jemný tupý; 16,0 cm	Graefe delicate hook blunt; 16.0 cm	208
118 91 0015	Cushing hák jemný fig.1; 28,0 cm	Cushing delicate hook fig.1; 28.0 cm	208
118 91 0016	Cushing hák jemný fig.2; 28,0 cm	Cushing delicate hook fig.2; 28.0 cm	208
118 91 0017	Cushing hák jemný fig.1; 19,0 cm	Cushing delicate hook fig.1; 19.0 cm	208
118 91 0018	Cushing hák jemný fig.2; 19,0 cm	Cushing delicate hook fig.2; 19.0 cm	208
118 91 0027	Hák jemný třízubý ostrý; 16,0 cm	Retractor sharp 3 prongs; 16.0 cm	207
118 91 0028	Hák jemný čtyřzubý ostrý; 16,0 cm	Retractor sharp 4 prongs; 16.0 cm	207
118 91 0035	Hák jemný třízubý tupý; 16,0 cm	Retractor blunt 3 prongs; 16.0 cm	207
118 91 0036	Hák jemný čtyřzubý tupý; 16,0 cm	Retractor blunt 4 prongs; 16.0 cm	207
118 91 0045	Hák jemný dvouzubý ohebný ostrý; 16,0 cm	Retractor sharp flex. 2 prongs; 16.0 cm	207
118 91 0046	Hák jemný třízubý ohebný ostrý; 16,0 cm	Retractor sharp flex. 3 prongs; 16.0 cm	207
118 91 0047	Hák jemný čtyřzubý ohebný ostrý; 16,0 cm	Retractor sharp flex. 4 prongs; 16.0 cm	207
118 91 0048	Hák jemný dvouzubý ohebný tupý; 16,0 cm	Retractor blunt flex. 2 prongs; 16.0 cm	207

číslo – number	název	item	strana – page
118 91 0049	Hák jemný třízubý ohebný tupý; 16,0 cm	Retractor blunt flex. 3 prongs; 16,0 cm	207
118 91 0050	Hák jemný čtyřzubý ohebný tupý; 16,0 cm	Retractor blunt flex. 4 prongs; 16,0 cm	207
118 91 0051	Joseph hák jemný; 16,0 cm	Joseph delicate hook; 16,0 cm	207
118 91 0052	Joseph hák jemný; 2,0 mm; 16,0 cm	Joseph delicate hook; 2,0 mm; 16,0 cm	207
118 91 0053	Joseph hák jemný; 5,0 mm; 16,0 cm	Joseph delicate hook; 5,0 mm; 16,0 cm	207
118 91 0054	Joseph hák jemný; 7,0 mm; 16,0 cm	Joseph delicate hook; 7,0 mm; 16,0 cm	207
118 91 0055	Joseph hák jemný; 10,0 mm; 16,0 cm	Joseph delicate hook; 10,0 mm; 16,0 cm	207
118 91 0069	Mini-Langenbeck hák jemný; 10x6 mm; 16,0 cm	Mini-Langenbeck retractor; 10x6 mm; 16,0 cm	209; 435
118 91 0070	Mini-Langenbeck hák jemný; 17x5 mm; 16,0 cm	Mini-Langenbeck retractor; 17x5 mm; 16,0 cm	209
118 91 0071	Mini-Langenbeck hák jemný; 20x6 mm; 16,0 cm	Mini-Langenbeck retractor; 20x6 mm; 16,0 cm	209
118 91 0072	Mini-Langenbeck hák jemný; 22x8 mm; 16,0 cm	Mini-Langenbeck retractor; 22x8 mm; 16,0 cm	209
118 91 0077	Desmarres držátko víček; 16,0 mm; 13,0 cm	Desmarres delicate hook; 16,0 mm; 13,0 cm	209
118 91 0078	Desmarres držátko víček; 18,0 mm; 13,0 cm	Desmarres delicate hook; 18,0 mm; 13,0 cm	209
118 91 0085	Cushing hák jemný; 8,0 mm; 20,0 cm	Cushing delicate hook; 8,0 mm; 20,0 cm	209
118 91 0086	Cushing hák jemný; 10,0 mm; 20,0 cm	Cushing delicate hook; 10,0 mm; 20,0 cm	209
118 91 0087	Cushing hák jemný; 12,0 mm; 20,0 cm	Cushing delicate hook; 12,0 mm; 20,0 cm	209
118 91 0088	Cushing hák jemný; 14,0 mm; 20,0 cm	Cushing delicate hook; 14,0 mm; 20,0 cm	209
118 91 0089	Cushing hák jemný; 16,0 mm; 20,0 cm	Cushing delicate hook; 16,0 mm; 20,0 cm	209
118 91 0090	Cushing hák jemný; 18,0 mm; 20,0 cm	Cushing delicate hook; 18,0 mm; 20,0 cm	209
118 91 0091	Cushing hák jemný; 8,0 mm; 24,0 cm	Cushing delicate hook; 8,0 mm; 24,0 cm	209
118 91 0092	Cushing hák jemný; 10,0 mm; 24,0 cm	Cushing delicate hook; 10,0 mm; 24,0 cm	209
118 91 0093	Cushing hák jemný; 12,0 mm; 24,0 cm	Cushing delicate hook; 12,0 mm; 24,0 cm	209
118 91 0094	Cushing hák jemný; 14,0 mm; 24,0 cm	Cushing delicate hook; 14,0 mm; 24,0 cm	209
118 91 0095	Cushing hák jemný; 16,0 mm; 24,0 cm	Cushing delicate hook; 16,0 mm; 24,0 cm	209
118 91 0096	Cushing hák jemný; 18,0 mm; 24,0 cm	Cushing delicate hook; 18,0 mm; 24,0 cm	209
118 91 0097	Gil-Vernet hák páteřní jemný; 9,0 mm; 24,5 cm	Gil-Vernet spinal hook; 9,0 mm; 24,5 cm	211
118 91 0098	Gil-Vernet hák páteřní jemný; 11,0 mm; 24,5 cm	Gil-Vernet spinal hook; 11,0 mm; 24,5 cm	211
118 91 0100	Gil-Vernet hák páteřní jemný; 15,0 mm; 24,5 cm	Gil-Vernet spinal hook; 15,0 mm; 24,5 cm	211
118 91 0101	Gil-Vernet hák páteřní jemný; 18,0 mm; 24,5 cm	Gil-Vernet spinal hook; 18,0 mm; 24,5 cm	211
118 91 0109	Senn-Miller hák páteřní jemný ostrý; 16,0 cm	Senn-Miller spinal hook sharp; 16,0 cm	211
118 91 0110	Senn-Miller hák páteřní jemný tupý; 16,0 cm	Senn-Miller spinal hook blunt; 16,0 cm	211
118 91 0135	Kocher hák na rány osmizubý ostrý; 22,0 cm	Kocher retractor 8 prongs sharp; 22,0 cm	212
118 91 0147	Kocher hák na rány osmizubý tupý; 22,0 cm	Kocher retractor 8 prongs blunt; 22,0 cm	212
118 91 0152	Koerte hák na rány; 26x40 mm; 24,0 cm	Koerte retractor; 26x40 mm; 24,0 cm	213
118 91 0153	Koerte hák na rány; 26x40 mm; 24,0 cm	Koerte retractor; 26x40 mm; 24,0 cm	213
118 91 0160	Israel hák na rány pětizubý; 45x50 mm; 25,0 cm	Israel retractor 5 prongs; 45x50 mm; 25,0 cm	214
118 91 0162	Israel hák na rány šestizubý; 70x70mm; 25,0 cm	Israel retractor 6 prongs; 70x70mm; 25,0 cm	214
118 91 0163	Langenbeck hák na rány; 55x20 mm; 21,0 cm	Langenbeck retractor; 55x20 mm; 21,0 cm	215
118 91 0164	Langenbeck hák na rány; 60x20 mm; 21,0 cm	Langenbeck retractor; 60x20 mm; 21,0 cm	215
118 91 0165	Langenbeck hák na rány; 63x20 mm; 21,0 cm	Langenbeck retractor; 63x20 mm; 21,0 cm	215
118 91 0185	Kocher hák na rány; 40x18 mm; 23,0 cm	Kocher retractor; 40x18 mm; 23,0 cm	216
118 91 0186	Kocher hák na rány; 60x20 mm; 23,0 cm	Kocher retractor; 60x20 mm; 23,0 cm	216
118 91 0187	Kocher hák na rány; 60x25 mm; 23,0 cm	Kocher retractor; 60x25 mm; 23,0 cm	216
118 91 0188	Kocher hák na rány; 75x30 mm; 23,0 cm	Kocher retractor; 75x30 mm; 23,0 cm	216
118 91 0189	Kocher hák na rány; 75x40 mm; 23,0 cm	Kocher retractor; 75x40 mm; 23,0 cm	216
118 91 0197	Brunner hák na rány; 80x20 mm; 25,0 cm	Brunner retractor; 80x20 mm; 25,0 cm	217
118 91 0198	Brunner hák na rány; 100x20 mm; 25,0 cm	Brunner retractor; 100x20 mm; 25,0 cm	217
118 91 0199	Brunner hák na rány; 120x25 mm; 25,0 cm	Brunner retractor; 120x25 mm; 25,0 cm	217
118 91 0200	Brunner hák na rány; 140x25 mm; 25,0 cm	Brunner retractor; 140x25 mm; 25,0 cm	217
118 91 0201	Brunner hák na rány; 160x30 mm; 25,0 cm	Brunner retractor; 160x30 mm; 25,0 cm	217
118 91 0202	Brunner hák na rány; 180x30 mm; 25,0 cm	Brunner retractor; 180x30 mm; 25,0 cm	217
118 91 0208	Middeldorpf hák na rány; 14x17 mm; 21,5 cm	Middeldorpf retractor; 14x17 mm; 21,5 cm	218
118 91 0209	Middeldorpf hák na rány; 20x22 mm; 22,0 cm	Middeldorpf retractor; 20x22 mm; 22,0 cm	218
118 91 0210	Middeldorpf hák na rány; 26x30 mm; 23,5 cm	Middeldorpf retractor; 26x30 mm; 23,5 cm	218
118 91 0211	Richardson hák na rány; 28x20 mm; 24,0 cm	Richardson retractor; 28x20 mm; 24,0 cm	219
118 91 0212	Richardson hák na rány; 36x28 mm; 24,0 cm	Richardson retractor; 36x28 mm; 24,0 cm	219
118 91 0213	Richardson hák na rány; 44x38 mm; 24,0 cm	Richardson retractor; 44x38 mm; 24,0 cm	219
118 91 0214	Richardson hák na rány; 52x22 mm; 24,0 cm	Richardson retractor; 52x22 mm; 24,0 cm	219
118 91 0215	Richardson hák na rány; 65x50 mm; 24,0 cm	Richardson retractor; 65x50 mm; 24,0 cm	219
118 91 0216	Richardson-Eastman hák na rány fig.1+2	Richardson-Eastman retractor fig.1+2	219
118 91 0217	Richardson-Eastman hák na rány fig.1; 26,0 cm	Richardson-Eastman retractor fig.1; 26,0 cm	219
118 91 0218	Richardson-Eastman hák na rány fig.2; 28,0 cm	Richardson-Eastman retractor fig.2; 28,0 cm	219
118 91 0225	Fritsch hák břišní; 45x40 mm; 24,0 cm	Fritsch retractor; 45x40 mm; 24,0 cm	220
118 91 0226	Fritsch hák břišní; 45x50 mm; 24,0 cm	Fritsch retractor; 45x50 mm; 24,0 cm	220
118 91 0227	Fritsch hák břišní; 45x60 mm; 24,0 cm	Fritsch retractor; 45x60 mm; 24,0 cm	220
118 91 0228	Fritsch hák břišní; 45x75 mm; 24,0 cm	Fritsch retractor; 45x75 mm; 24,0 cm	220
118 91 0229	Fritsch hák břišní; 65x85 mm; 24,0 cm	Fritsch retractor; 65x85 mm; 24,0 cm	220
118 91 0230	Kocher hák břišní; 70x25 mm; 22,0 cm	Kocher retractor; 70x25 mm; 22,0 cm	221
118 91 0233	Kocher hák břišní; 80x60 mm; 25,0 cm	Kocher retractor; 80x60 mm; 25,0 cm	221
118 91 0242	Harrington hák břišní; 127x40 mm; 32,0 cm	Harrington retractor; 127x40 mm; 32,0 cm	224
118 91 0243	Harrington hák břišní; 127x62 mm; 32,0 cm	Harrington retractor; 127x62 mm; 32,0 cm	224
118 91 0244	Harrington hák břišní; 175x64 mm; 32,0 cm	Harrington retractor; 175x64 mm; 32,0 cm	224
118 91 0246	Mikulicz hák břišní; 85x35 mm; 26,0 cm	Mikulicz retractor; 85x35 mm; 26,0 cm	224
118 91 0247	Mikulicz hák břišní; 120x50 mm; 26,0 cm	Mikulicz retractor; 120x50 mm; 26,0 cm	224
118 91 0248	Mikulicz hák břišní; 155x50 mm; 26,0 cm	Mikulicz retractor; 155x50 mm; 26,0 cm	224
118 91 0249	Kelly hák břišní; 160x38 mm; 27,0 cm	Kelly retractor; 160x38 mm; 27,0 cm	221
118 91 0250	Kelly hák břišní; 160x57 mm; 27,0 cm	Kelly retractor; 160x57 mm; 27,0 cm	221
118 91 0251	Kelly hák břišní; 190x38 mm; 27,0 cm	Kelly retractor; 190x38 mm; 27,0 cm	221
118 91 0252	Kelly hák břišní; 190x57 mm; 27,0 cm	Kelly retractor; 190x57 mm; 27,0 cm	221
118 91 0253	Deaver hák břišní; 19,0 mm; 18,0 cm	Deaver retractor; 19,0 mm; 18,0 cm	222
118 91 0254	Deaver hák břišní; 22,0 mm; 21,5 cm	Deaver retractor; 22,0 mm; 21,5 cm	222
118 91 0255	Deaver hák břišní; 25,0 mm; 23,0 cm	Deaver retractor; 25,0 mm; 23,0 cm	222
118 91 0256	Deaver hák břišní; 25,0 mm; 30,0 cm	Deaver retractor; 25,0 mm; 30,0 cm	222
118 91 0257	Deaver hák břišní; 25,0 mm; 33,0 cm	Deaver retractor; 25,0 mm; 33,0 cm	222



číslo – number	název	item	strana – page
118 91 0258	Deaver hák břišní; 25,0 mm; 36,0 cm	Deaver retractor; 25.0 mm; 36.0 cm	222
118 91 0259	Deaver hák břišní; 38,0 mm; 30,0 cm	Deaver retractor; 38.0 mm; 30.0 cm	223
118 91 0260	Deaver hák břišní; 50,0 mm; 30,0 cm	Deaver retractor; 50.0 mm; 30.0 cm	223
118 91 0261	Deaver hák břišní; 75,0 mm; 30,0 cm	Deaver retractor; 75.0 mm; 30.0 cm	223
118 91 0294	Roux hák sada fig.1-3; 16,5 cm	Roux retractor set fig.1-3; 16.5 cm	227
118 91 0295	Roux hák fig.1	Roux retractor fig.1	227
118 91 0296	Roux hák fig.2	Roux retractor fig.2	227
118 91 0297	Roux hák fig.3	Roux retractor fig.3	227
118 91 0298	Farabeuf hák sada fig.1+2; 12,0 cm	Farabeuf retractor set fig.1+2; 12.0 cm	227
118 91 0299	Farabeuf hák fig.1	Farabeuf retractor fig.1	227
118 91 0300	Farabeuf hák fig.2	Farabeuf retractor fig.2	227
118 91 0301	Farabeuf hák sada fig.1+2; 15,0 cm	Farabeuf retractor set fig.1+2; 15.0 cm	227
118 91 0302	Farabeuf hák fig.1	Farabeuf retractor fig.1	227
118 91 0303	Farabeuf hák fig.2	Farabeuf retractor fig.2	227
118 91 0304	Parker hák sada malá fig.1+2; 13,5 cm	Parker retractor set small fig.1+2; 13.5 cm	227
118 91 0305	Parker hák fig.1	Parker retractor fig.1	227
118 91 0306	Parker hák fig.2	Parker retractor fig.2	227
118 91 0307	Parker hák sada velká fig.1+2; 18,0 cm	Parker retractor set large fig.1+2; 18.0 cm	228
118 91 0308	Parker hák fig.1	Parker retractor fig.1	228
118 91 0309	Parker hák fig.2	Parker retractor fig.2	228
118 91 0310	Mathieu hák sada fig.1+2; 20,0 cm	Mathieu retractor set fig.1+2; 20.0 cm	228
118 91 0311	Mathieu hák fig.1	Mathieu retractor fig.1	228
118 91 0312	Mathieu hák fig.2	Mathieu retractor fig.2	228
118 91 0313	Parker-Langenbeck hák sada fig.1+2; 21,0 cm	Parker-Langenbeck retractor set fig.1+2; 21.0 cm	228
118 91 0314	Parker-Langenbeck hák fig.1	Parker-Langenbeck retractor fig.1	228
118 91 0315	Parker-Langenbeck hák fig.2	Parker-Langenbeck retractor fig.2	228
118 91 0316	Goelet hák; 19,0 cm	Goelet retractor; 19.0 cm	228
118 91 0317	Braun hák dekapilační; 30,0 cm	Braun decapilation hook; 30.0 cm	466
118 91 0320	Iterson hák na průdušnici fig.1; 16,0 cm	Iterson trachea retractor fig.1; 16.0 cm	396; 435
118 91 0321	Iterson hák na průdušnici fig.2; 16,0 cm	Iterson trachea retractor fig.2; 16.0 cm	396
118 91 0323	Lukens hák na průdušnici; 17,0 cm	Lukens trachea hook; 17.0 cm	396
118 91 0335	Fomon háček jemný dvouzubý; 16,0 cm	Fomon delicate hook 2 prongs; 16.0 cm	395
118 91 0336	Freer háček jemný dvouzubý; 15,0 cm	Freer delicate hook 2 prongs; 15.0 cm	395
118 91 0337	Cottle háček jemný dvouzubý ostrý; 14,0 cm	Cottle hook 2 prongs sharp; 14.0 cm	395
118 91 0338	Cottle háček jemný dvouzubý ostrý/tupý; 14,0 cm	Cottle hook 2 prongs sharp/blunt; 14.0 cm	395
118 91 0339	Cottle háček jemný dvouzubý ostrý/tupý; 14,0 cm	Cottle hook 2 prongs sharp/blunt; 14.0 cm	395
118 91 0343	Cottle-Neivert hák; 20,0 cm	Cottle-Neivert hook; 20.0 cm	395
118 91 0346	Cottle hák; 15,0 cm	Cottle hook; 15.0 cm	395
118 91 0347	Cottle hák; 15,0 cm	Cottle hook; 15.0 cm	395
118 91 0348	Aufricht (Walter) hák; 13,5 cm	Aufricht (Walter) hook; 13.5 cm	394
118 91 0349	Aufricht hák; 19,0 cm	Aufricht hook; 19.0 cm	394
118 91 0350	Háček na galeu; 7 mm; 31,0 cm	Galea hook; 7 mm; 31.0 cm	528
118 91 0351	Háček na galeu; 9 mm; 41,0 cm	Galea hook; 9 mm; 41.0 cm	528
118 91 0352	Horsley háček na nervy; 20,0 cm	Horsley nerve root retractor; 20.0 cm	529
118 91 0353	Sachs háček na nervy; 21,0 cm	Sachs nerve root retractor; 21.0 cm	529
118 91 0354	Scoville háček na nervy; 23,0 cm	Scoville nerve root retractor; 23.0 cm	529
118 91 0355	Love háček na nervy; přímý	Love nerve root retractor. straight	530
118 91 0356	Love háček na nervy; 45°	Love nerve root retractor. 45°	530
118 91 0357	Love háček na nervy; 90°	Love nerve root retractor. 90°	530
118 91 0358	Love modif. háček na nervy; 3 mm; 7,0 cm	Love modif. nerve root retractor; 3 mm; 7.0 cm	530
118 91 0359	Love modif. háček na nervy; 5 mm; 7,0 cm	Love modif. nerve root retractor; 5 mm; 7.0 cm	530
118 91 0360	Love modif. háček na nervy; 7 mm; 7,0 cm	Love modif. nerve root retractor; 7 mm; 7.0 cm	530
118 91 0361	Love modif. háček na nervy; 3 mm; 10,0 cm	Love modif. nerve root retractor; 3 mm; 10.0 cm	530
118 91 0362	Love modif. háček na nervy; 5 mm; 10,0 cm	Love modif. nerve root retractor; 5 mm; 10.0 cm	530
118 91 0363	Love modif. háček na nervy; 7 mm; 10,0 cm	Love modif. nerve root retractor; 7 mm; 10.0 cm	530
118 91 0364	Háček na nervy; 20,0 cm	Nerve root retractor; 20.0 cm	530
118 91 0365	Martin háček na nervy; 21,0 cm	Martin nerve root retractor; 21.0 cm	530
118 91 0366	Groningen háček na nervy; 26,0 cm	Groningen nerve hook; 26.0 cm	531
118 91 0367	Groningen háček na nervy; 26,0 cm	Groningen nerve hook; 26.0 cm	531
118 91 0368	Smithwick háček na nervy; 17,0 cm	Smithwick nerve hook; 17.0 cm	531
118 91 0369	Smithwick háček na nervy; 21,0 cm	Smithwick nerve hook; 21.0 cm	531
118 91 0370	Dandy háček na nervy; 20,0 cm	Dandy nerve hook; 20.0 cm	531
118 91 0371	Krayenbuehl háček na nervy; 18,5 cm	Krayenbuehl nerve hook; 18.5 cm	532
118 91 0372	Krayenbuehl háček na nervy; 18,5 cm	Krayenbuehl nerve hook; 18.5 cm	532
118 91 0373	Krayenbuehl háček na nervy; 18,5 cm	Krayenbuehl nerve hook; 18.5 cm	532
118 91 0374	Krayenbuehl háček na nervy; 18,5 cm	Krayenbuehl nerve hook; 18.5 cm	532
118 91 0375	Biemer háček na nervy; 16,0 cm	Biemer nerve hook; 16.0 cm	532
118 91 0376	Fisch háček na nervy; 18,5 cm	Fisch nerve hook; 18.5 cm	532
118 91 0377	Fisch háček na nervy; 18,5 cm	Fisch nerve hook; 18.5 cm	532
118 91 0388	Emmet hák na fistuli fig. 1; 22,0 cm	Emmet fistula hook fig. 1; 22.0 cm	467
118 91 0389	Emmet hák na fistuli fig. 2; 22,0 cm	Emmet fistula hook fig. 2; 22.0 cm	467
118 91 0390	Emmet hák na fistuli fig. 3; 22,0 cm	Emmet fistula hook fig. 3; 22.0 cm	467
118 91 0391	Emmet hák na fistuli fig. 4; 22,0 cm	Emmet fistula hook fig. 4; 22.0 cm	467
118 91 0392	Emmet hák na fistuli fig. 5; 22,0 cm	Emmet fistula hook fig. 5; 22.0 cm	467
118 91 0393	Simon hák na fistuli 1 hrot; 22,0 cm	Simon fistula hook; 22.0 cm	467
118 91 0394	Simon hák na fistuli 2 hroty; 22,0 cm	Simon fistula hook; 22.0 cm	467
118 91 0395	Beacham amniotom; 26,0 cm	Beacham amniotome; 26.0 cm	466
118 91 0396	Blount hák na meniskus; 17,5 cm	Blount meniscus hook; 17.5 cm	225
118 91 0404	Caspar nástroj mikro; 23,0 cm	Caspar micro instrument; 23.0 cm	533
118 91 0405	Okonek nástroj mikro; 3 mm; 23 cm	Okonek micro instrument 3 mm; 23.0 cm	533
118 91 0406	Okonek nástroj mikro; 4 mm; 23 cm	Okonek micro instrument 4 mm; 23.0 cm	533
118 91 0407	Okonek nástroj mikro; 5 mm; 23 cm	Okonek micro instrument 5 mm; 23.0 cm	533
118 91 0408	Okonek nástroj mikro; 8 mm; 23 cm	Okonek micro instrument 8 mm; 23.0 cm	533
118 91 0409	Young hák na prostatu; 11x50 mm; 21 cm	Young retractor for prostate; 11x50 mm; 21 cm	226

číslo – number	název	item	strana – page
118 91 0410	Young hák na prostatu; 38×64 mm; 22 cm	Young retractor for prostate; 38×64 mm; 22 cm	226
118 91 0411	Young hák na prostatu; 25×25 mm; 21 cm	Young retractor for prostate; 25×25 mm; 21 cm	226
118 91 0412	Young hák na prostatu; 39×35 mm; 22 cm	Young retractor for prostate; 39×35 mm; 22 cm	226
118 91 0419	Hartmann háček ušní; 60×20 mm; 23,0 cm	Hartmann ear hook; 60×20 mm; 23.0 cm	394
118 91 0420	Zaufal háček ušní; 16,5 cm	Zaufal ear hook; 16.5 cm	394
118 91 0421	Wagener háček ušní fig.1; 14,0 cm	Wagener ear hook fig.1; 14.0 cm	394
118 91 0422	Wagener háček ušní fig.2; 14,0 cm	Wagener ear hook fig.2; 14.0 cm	394
118 91 0423	Wagener háček ušní fig.3; 14,0 cm	Wagener ear hook fig.3; 14.0 cm	394
118 91 0424	Wagener háček ušní fig.4; 14,0 cm	Wagener ear hook fig.4; 14.0 cm	394
119 07 0010	Roser-König rozvěrač úst; 19,0 cm	Roser-König mouth retractor; 19.0 cm	397
119 07 0020	Heister rozvěrač úst; 13,0 cm	Heister mouth retractor; 13.0 cm	397
119 08 0610	Walton rozvěrač ran páteří s hrotem pravý; 18,0 cm	Walton retractor right; 18.0 cm	237
119 08 0620	Walton rozvěrač ran páteří s hrotem levý; 18,0 cm	Walton retractor left; 18.0 cm	237
119 08 0650	Adson rozvěrač ran ostrý; 3×4 zuby; 23,3 cm	Adson retractor 3×4 teeth sharp; 23.3 cm	237
119 08 0680	Weitlaner rozvěrač ran ostrý; 4×3 zuby; 16,5 cm	Weitlaner retractor 4×3 teeth sharp; 16.5 cm	232
119 08 0690	Weitlaner rozvěrač ran tupý; 4×3 zuby; 16,5 cm	Weitlaner retractor 4×3 teeth blunt; 16.5 cm	232
119 08 1040	Weitlaner rozvěrač ran ostrý; 3×4 zuby; 14,0 cm	Weitlaner retractor 3×4 teeth sharp; 14.0 cm	232
119 08 1060	Weitlaner rozvěrač ran tupý; 3×4 zuby; 14,0 cm	Weitlaner retractor 3×4 teeth blunt; 14.0 cm	232; 435
119 08 1080	Rozvěrač ran s lomen. rameny ostrý; 3×3 zuby; 14,0 cm	Retractor 3×3 teeth sharp; 14.0 cm	237
119 08 1090	Rozvěrač ran s lomen. rameny tupý; 3×3 zuby; 14,0 cm	Retractor 3×3 teeth blunt; 14.0 cm	237
119 08 1120	Rozvěrač ran s lomen. rameny tupý; 3×4 zuby; 13,0 cm	Retractor 3×4 teeth blunt; 13.0 cm	237
119 08 1430	Základna rozvěrače	Retractor base	248; 249
119 08 1440	Trmen základny	Base clamp (tube-to-tube clamp)	248; 249
119 08 1460	Týč spojovací	Connecting horizontal rod	248; 249
119 08 1470	Trmen spojovací	Connecting clamp	248; 249
119 08 1480	Trmen háku	Hook clamp	248; 249
119 08 1490	Rameno háku; 25 cm	Hook arm; 25 cm	248; 249
119 08 1500	Hák rádiusový; L=120 mm	Hook; L=120 mm	248; 249
119 08 1510	Hák rádiusový; L=80mm	Hook; L=80 mm	248; 249
119 08 1560	Týč spojovací 1	Connecting horizontal rod 1	248; 249
119 08 1570	Týč spojovací 2	Connecting horizontal rod 2	248; 249
119 08 1590	Rozvěrač břišní žeberního oblouku	Costal arch abdominal retractor	249
119 08 1600	Rozvěrač břišní	Abdominal retractor	249
119 08 1610	Rozvěrač břišní Rochard	Rochard abdominal retractor	249
119 08 1620	Rozvěrač břišní univerzální	Universal abdominal retractor	248
119 08 1630	Hrazda	Horizontal bar	248; 249
119 08 1640	Rameno háku dlouhé; 40 cm	Hook arm long; 40 cm	248; 249
119 10 0100	Rozvěrač víček kojenecký; 4,3 cm	Lid retractor for infants; 4.3 cm	231
119 14 0050	Finochietto rozvěrač hrudní; 21,5 cm	Finochietto pectoral retractor; 21.5 cm	238
119 17 0030	Rozvěrač pro laminectomii ostrý; 7×7 zubů; 32,2 cm	Laminectomy retractor 7×7 teeth sharp; 32.2 cm	240
119 17 0060	Rozvěrač pro laminectomii tupý; 4×4 zubů; 32,2 cm	Laminectomy retractor 4×4 teeth blunt; 32.2 cm	240
119 38 0070	Rozvěrač víček mikro; 4,6 cm	Lid retractor micro; 4.6 cm	231
119 91 0001	Finsen rozvěrač ostrý; 2×3 zuby; 5,0 cm	Finsen retractor sharp 2×3 prongs; 5.0 cm	231
119 91 0002	Finsen rozvěrač ostrý; 3×4 zuby; 7,0 cm	Finsen retractor sharp 3×4 prongs; 7.0 cm	231
119 91 0003	Finsen rozvěrač tupý; 2×3 zuby; 5,0 cm	Finsen retractor blunt 2×3 prongs; 5.0 cm	231
119 91 0004	Finsen rozvěrač tupý; 3×4 zuby; 7,0 cm	Finsen retractor blunt 3×4 prongs; 7.0 cm	231
119 91 0005	Rozvěrač ostrý; 4×4 zuby; 10,0 cm	Retractor sharp; 4×4 teeth; 10.0 cm	231
119 91 0006	Rozvěrač tupý; 4×4 zuby; 10,0 cm	Retractor blunt; 4×4 teeth; 10.0 cm	231
119 91 0007	Alm rozvěrač ostrý; 4×4 zuby; 7,0 cm	Alm retractor sharp 4×4 prongs; 7.0 cm	231
119 91 0008	Alm rozvěrač ostrý; 4×4 zuby; 10,0 cm	Alm retractor sharp 4×4 prongs; 10.0 cm	231
119 91 0009	Alm rozvěrač tupý; 4×4 zuby; 7,0 cm	Alm retractor blunt 4×4 prongs; 7.0 cm	231
119 91 0010	Alm rozvěrač tupý; 4×4 zuby; 10,0 cm	Alm retractor blunt 4×4 prongs; 10.0 cm	231
119 91 0013	Jansen rozvěrač ostrý; 4×4 zuby; 10,0 cm	Jansen retractor sharp 4×4 prongs; 10.0 cm	231
119 91 0014	Jansen rozvěrač tupý; 4×4 zuby; 10,0 cm	Jansen retractor blunt 4×4 prongs; 10.0 cm	231
119 91 0020	Weitlaner rozvěrač ostrý; 2×3 zuby; 10,5 cm	Weitlaner retractor sharp; 2×3 teeth; 10.5 cm	232
119 91 0021	Weitlaner rozvěrač tupý; 2×3 zuby; 10,5 cm	Weitlaner retractor blunt; 2×3 teeth; 10.5 cm	232
119 91 0026	Weitlaner rozvěrač ostrý; 3×4 zuby; 20,0 cm	Weitlaner retractor sharp; 3×4 teeth; 20.0 cm	232
119 91 0027	Weitlaner rozvěrač tupý; 3×4 zuby; 20,0 cm	Weitlaner retractor blunt; 3×4 teeth; 20.0 cm	232
119 91 0028	Weitlaner rozvěrač ostrý; 3×4 zuby; 25,0 cm	Weitlaner retractor sharp; 3×4 teeth; 25.0 cm	232
119 91 0029	Weitlaner rozvěrač tupý; 3×4 zuby; 25,0 cm	Weitlaner retractor blunt; 3×4 teeth; 25.0 cm	232
119 91 0030	Weitlaner rozvěrač ostrý; 5×6 zubů; 26,0 cm	Weitlaner retractor sharp; 5×6 teeth; 26.0 cm	232
119 91 0031	Weitlaner rozvěrač tupý; 5×6 zubů; 26,0 cm	Weitlaner retractor blunt; 5×6 teeth; 26.0 cm	232
119 91 0032	Henley rozvěrač ostrý; 3×4 zuby; 16,5 cm	Henley retractor sharp; 3×4 teeth; 16.5 cm	232
119 91 0033	Henley vyměnitelná lopatka; 16×19 mm	Henley exchangeable blade; 16×19 mm	232
119 91 0034	Henley vyměnitelná lopatka; 16×25 mm	Henley exchangeable blade; 16×25 mm	232
119 91 0035	Henley vyměnitelná lopatka; 16×32 mm	Henley exchangeable blades; 16×32 mm	232
119 91 0036	Henley rozvěrač tupý; 3×4 zuby; 16,5 cm	Henley retractor blunt; 3×4 teeth; 16.5 cm	232
119 91 0042	Wullstein rozvěrač ostrý; 3×3 zuby; 10,5 cm	Wullstein retractor sharp; 3×3 teeth; 10.5 cm	233
119 91 0043	Wullstein rozvěrač ostrý; 3×3 zuby; 13,0 cm	Wullstein retractor sharp; 3×3 teeth; 13.0 cm	233
119 91 0044	Wullstein rozvěrač ostrý; 3×3 zuby; 16,0 cm	Wullstein retractor sharp; 3×3 teeth; 16.0 cm	233
119 91 0045	Wullstein rozvěrač tupý; 3×3 zuby; 10,5 cm	Wullstein retractor blunt; 3×3 teeth; 10.5 cm	233
119 91 0046	Wullstein rozvěrač tupý; 3×3 zuby; 13,0 cm	Wullstein retractor blunt; 3×3 teeth; 13.0 cm	233
119 91 0047	Wullstein rozvěrač tupý; 3×3 zuby; 16,0 cm	Wullstein retractor blunt; 3×3 teeth; 16.0 cm	233
119 91 0048	Mollison rozvěrač ostrý; 4×4 zuby; 15,0 cm	Mollison retractor sharp; 4×4 teeth; 15.0 cm	233
119 91 0049	Mollison rozvěrač tupý; 4×4 zuby; 15,0 cm	Mollison retractor blunt; 4×4 teeth; 15.0 cm	233
119 91 0050	Miskimon rozvěrač ostrý; 7×7 zubů; 22,0 cm	Miskimon retractor sharp; 7×7 teeth; 22.0 cm	233
119 91 0051	Miskimon rozvěrač tupý; 7×7 zubů; 22,0 cm	Miskimon retractor blunt; 7×7 teeth; 22.0 cm	233
119 91 0052	Adson rozvěrač ostrý; 4×4 zuby; 20,0 cm	Adson retractor sharp; 4×4 teeth; 20.0 cm	233
119 91 0053	Adson rozvěrač tupý; 4×4 zuby; 20,0 cm	Adson retractor blunt; 4×4 teeth; 20.0 cm	233
119 91 0054	Anderson-Adson rozvěrač ostrý; 4×4 zuby; 20,0 cm	Anderson-Adson retractor sharp; 4×4 teeth; 20.0 cm	233
119 91 0055	Anderson-Adson rozvěrač tupý; 4×4 zuby; 20,0 cm	Anderson-Adson retractor blunt; 4×4 teeth; 20.0 cm	233
119 91 0062	Cone rozvěrač ostrý; 3×4 zuby; 16,5 cm	Cone retractor sharp; 3×4 teeth; 16.5 cm	234
119 91 0066	Cone rozvěrač tupý; 3×4 zuby; 16,5 cm	Cone retractor blunt; 3×4 teeth; 16.5 cm	234
119 91 0069	Beckmann rozvěrač ostrý; 4×4 zuby; 31,0 cm	Beckmann retractor sharp 4×4 prongs; 31.0 cm	234



číslo – number	název	item	strana – page
119 91 0070	Beckmann rozvěrač tupý; 4x4 zuby; 31,0 cm	Beckmann retractor blunt 4x4 prongs; 31.0 cm	234
119 91 0081	Beckmann-Eaton rozvěrač ostrý; 33,0 cm	Beckmann-Eaton retractor sharp; 33.0 cm	234
119 91 0082	Beckmann-Eaton rozvěrač tupý; 33,0 cm	Beckmann-Eaton retractor blunt; 33.0 cm	234
119 91 0085	Gelpi rozvěrač; 9,0 cm	Gelpi retractor; 9.0 cm	235
119 91 0086	Gelpi rozvěrač; 11,0 cm	Gelpi retractor; 11.0 cm	235
119 91 0087	Gelpi rozvěrač; 14,0 cm	Gelpi retractor; 14.0 cm	235
119 91 0088	Gelpi rozvěrač; 19,0 cm	Gelpi retractor; 19.0 cm	235
119 91 0089	Gelpi rozvěrač; 19,0 cm	Gelpi retractor; 19.0 cm	235
119 91 0094	Markham-Meyerding rozvěrač fig.1; 18,0 cm	Markham-Meyerding retractor fig.1; 18.0 cm	235
119 91 0095	Markham-Meyerding rozvěrač fig.2; 18,0 cm	Markham-Meyerding retractor fig.2; 18.0 cm	235
119 91 0099	Darling rozvěrač fig.1; 18,0 cm	Darling retractor fig.1; 18.0 cm	235
119 91 0100	Darling rozvěrač fig.2; 18,0 cm	Darling retractor fig.2; 18.0 cm	235
119 91 0103	Plester rozvěrač pravý; 10,0 cm	Plester retractor; 10.0 cm	236
119 91 0104	Plester rozvěrač pravý; 13,0 cm	Plester retractor; 13.0 cm	236
119 91 0105	Plester rozvěrač levý; 10,0 cm	Plester retractor; 10.0 cm	236
119 91 0106	Plester rozvěrač levý; 13,0 cm	Plester retractor; 13.0 cm	236
119 91 0110	Mayo-Adams rozvěrač; 17,0 cm	Mayo-Adams retractor; 17.0 cm	236
119 91 0111	Mayo-Adams rozvěrač; 17,0 cm	Mayo-Adams retractor; 17.0 cm	236
119 91 0118	Gosset rozvěrač břišní; 14,0 cm	Gosset abdominal retractor; 14.0 cm	241
119 91 0119	Gosset rozvěrač břišní; 16,0 cm	Gosset abdominal retractor; 16.0 cm	241
119 91 0123	Balfour-Baby rozvěrač břišní; 9,0 cm	Balfour-Baby abdom.retractor; 9.0 cm	242
119 91 0124	Balfour rozvěrač břišní; 18,0 cm	Balfour abdominal retractor; 18.0 cm	242
119 91 0125	Balfour rozvěrač břišní; 20,0 cm	Balfour abdominal retractor; 20.0 cm	242
119 91 0126	Balfour rozvěrač břišní; 25,0 cm	Balfour abdominal retractor; 25.0 cm	242
119 91 0130	Dennis-Browne rozvěrač břišní komplet	Dennis-Browne abdominal retractor complete	243
119 91 0131	Dennis-Browne rám; 190x160 mm	Dennis-Browne frame; 190x160 mm	243
119 91 0132	Dennis-Browne lopatka; 40x30 mm	Dennis-Browne blade; 40x30 mm	243
119 91 0133	Dennis-Browne lopatka; 40x40 mm	Dennis-Browne blade; 40x40 mm	243
119 91 0134	O'Sullivan-O'Connor rozvěrač břišní komplet	O'Sullivan-O'Connor abdomin.retractor complete	243
119 91 0135	O'Sullivan-O'Connor rám břišní	O'Sullivan-O'Connor frame	243
119 91 0136	O'Sullivan-O'Connor lopatka; 110x70 mm	O'Sullivan-O'Connor blade; 110x70 mm	243
119 91 0137	O'Sullivan-O'Connor lopatka; 80x45 mm	O'Sullivan-O'Connor blade; 80x45 mm	243
119 91 0142	Franz rám břišní komplet	Franz abdominal retractor complete	245
119 91 0143	Franz rám břišní; 300x300 mm	Franz frame; 300x300 mm	245
119 91 0144	Franz lopatka; 38x60 mm	Franz retractor; 38x60 mm	245
119 91 0145	Franz lopatka; 50x65 mm	Franz retractor; 50x65 mm	245
119 91 0146	Franz rám břišní komplet	Franz abdominal retractor complete	245
119 91 0147	Franz lopatka; 45x80 mm	Franz retractor; 45x80 mm	245
119 91 0148	Franz lopatka; 60x85 mm	Franz retractor; 60x85 mm	245
119 91 0149	Franz lopatka; 105x35 mm	Franz retractor; 105x35 mm	245
119 91 0150	Franz lopatka; 98x50 mm	Franz retractor; 98x50 mm	245
119 91 0151	Kirschner rám břišní komplet	Kirschner abdominal retractor complete	244
119 91 0152	Kirschner rozvěrač břišní rámový	Kirschner abdominal retractor frame	244
119 91 0153	Kirschner lopatka; 40x55 mm	Kirschner retractor; 40x55 mm	244
119 91 0154	Kirschner lopatka; 50x65 mm	Kirschner retractor; 50x65 mm	244
119 91 0155	Kirschner lopatka; 78x65 mm	Kirschner retractor; 78x65 mm	244
119 91 0156	Kirschner lopatka; 80x90 mm	Kirschner retractor; 80x90 mm	244
119 91 0157	Semm rozvěrač břišní komplet	Semm abdominal retractor complete	244
119 91 0158	Semm rám; 275x250 mm	Semm frame; 275x250 mm	244
119 91 0159	Semm lopatka; 47x65 mm	Semm blade; 47x65 mm	244
119 91 0160	Semm lopatka; 50x54 mm	Semm blade; 50x54 mm	244
119 91 0161	Semm lopatka; 76x98 mm	Semm blade; 76x98 mm	244
119 91 0162	Semm lopatka; 98x52 mm	Semm blade; 98x52 mm	244
119 91 0163	Semm lopatka; 105x35 mm	Semm blade; 105x35 mm	244
119 91 0164	Collin-Baby rozvěrač břišní komplet	Collin-Baby abdominal retractor complete	246
119 91 0165	Lopatka; 23x44 mm	Blade; 23x44 mm	246
119 91 0166	Lopatka; 30x44 mm	Blade; 30x44 mm	246
119 91 0169	Collin rozvěrač břišní; 22,0 cm	Collin abdominal retractor; 22.0 cm	246
119 91 0170	Collin rozvěrač břišní; 22,0 cm	Collin abdominal retractor; 22.0 cm	246
119 91 0173	Ricard rozvěrač břišní; 28,0 cm	Ricard abdominal retractor; 28.0 cm	247
119 91 0174	Ricard rozvěrač břišní; 30,0 cm	Ricard abdominal retractor; 30.0 cm	247
119 91 0184	Percy talíř amputační	Percy amputation shield	250
119 91 0185	Jennings rozvěrač úst; 9,0 cm	Jennings mouth retractor; 9.0 cm	397
119 91 0186	Jennings rozvěrač úst; 11,0 cm	Jennings mouth retractor; 11.0 cm	397
119 91 0187	Jennings rozvěrač úst; 13,0 cm	Jennings mouth retractor; 13.0 cm	397
119 91 0188	Jennings rozvěrač úst; 15,0 cm	Jennings mouth retractor; 15.0 cm	397
119 91 0190	Whitehead rozvěrač úst; 11,0 cm	Whitehead mouth retractor; 11.0 cm	397
119 91 0191	Whitehead rozvěrač úst; 13,0 cm	Whitehead mouth retractor; 13.0 cm	397
119 91 0192	Whitehead rozvěrač úst; 15,0 cm	Whitehead mouth retractor; 15.0 cm	397
119 91 0197	Molt rozvěrač úst pro děti; 11,0 cm	Molt mouth retractor for children; 11.0 cm	397
119 91 0198	Molt rozvěrač úst pro dospělé; 14,0 cm	Molt mouth retractor for adults; 14.0 cm	397
119 91 0199	Denhart rozvěrač úst se západkou; 12,0 cm	Denhart mouth retractor; 12.0 cm	397
119 91 0222	MC Ivor rozvěrač úst komplet	MC Ivor mouth retractor set	398; 432; 434
119 91 0223	MC Ivor lopatka fig.1; 95x27 mm	MC Ivor blade fig. 1; 95x27 mm	398
119 91 0224	MC Ivor lopatka fig.2; 85x22 mm	MC Ivor blade fig. 2; 85x22 mm	398
119 91 0225	MC Ivor lopatka fig.3; 70x22 mm	MC Ivor blade fig. 3; 70x22 mm	398
119 91 0226	MC Ivor rám	MC Ivor frame	398
119 91 0244	Finochietto-Baby rozvěrač žeber; 7,5 cm	Finochietto-Baby rib spreader; 7.5 cm	239
119 91 0245	Finochietto rozvěrač žeber; 15,0 cm	Finochietto rib spreader; 15.0 cm	239
119 91 0246	Finochietto rozvěrač žeber; 19,0 cm	Finochietto rib spreader; 19.0 cm	239
119 91 0247	Finochietto rozvěrač žeber; 19,0 cm	Finochietto rib spreader; 19.0 cm	239
119 91 0280	Rozvěrač břišní řetízkový; 20,0 cm	Chain abdominal retractor; 20.0 cm	247
119 91 0281	Rozvěrač břišní řetízkový; 20,0 cm	Chain abdominal retractor; 20.0 cm	247
119 91 0282	Rozvěrač břišní řetízkový; 20,0 cm	Chain abdominal retractor; 20.0 cm	247

číslo – number	název	item	strana – page
119 91 0307	Hey rozvěrač pro diskektomii komplet	Hey discectomy retractor; complete	534
119 91 0308	Hey rozvěrač pro diskektomii	Hey discectomy retractor	534
119 91 0309	Hey lopatka s hroty; 37 mm	Hey vertebra pins; 37 mm	534
119 91 0310	Hey lopatka ostrá; 20×50 mm	Hey blade; sharp; 20×50 mm	534
119 91 0311	Hey lopatka tupá; 20×50 mm	Hey blade; blunt; 20×50 mm	534
119 91 0312	Hey lopatka s hroty; 53 mm	Hey vertebra pins; 53 mm	534
119 91 0313	Hey lopatka ostrá; 20×60 mm	Hey blade; sharp; 20×60 mm	534
119 91 0314	Hey lopatka tupá; 20×60 mm	Hey blade; blunt; 20×60 mm	534
119 91 0315	Hey lopatka s hroty; 62 mm	Hey vertebra pins; 62 mm	534
119 91 0316	Hey lopatka ostrá; 20×70 mm	Hey blade; sharp; 20×70 mm	534
119 91 0317	Hey lopatka tupá; 20×70 mm	Hey blade; blunt; 20×70 mm	534
119 91 0318	Retraktor pro diskektomii; levý; 50×10 mm; 17 cm	Discectomy retractor left; 50×10 mm; 17 cm	535
119 91 0319	Retraktor pro diskektomii; levý; 50×20 mm; 17 cm	Discectomy retractor left; 50×20 mm; 17 cm	535
119 91 0320	Retraktor pro diskektomii; levý; 60×10 mm; 17 cm	Discectomy retractor left; 60×10 mm; 17 cm	535
119 91 0321	Retraktor pro diskektomii; levý; 60×20 mm; 17 cm	Discectomy retractor left; 60×20 mm; 17 cm	535
119 91 0322	Retraktor pro diskektomii; levý; 70×10 mm; 17 cm	Discectomy retractor left; 70×10 mm; 17 cm	535
119 91 0323	Retraktor pro diskektomii; levý; 70×20 mm; 17 cm	Discectomy retractor left; 70×20 mm; 17 cm	535
119 91 0324	Retraktor pro diskektomii; pravý; 50×10 mm; 17 cm	Discectomy retractor right; 50×10 mm; 17 cm	535
119 91 0325	Retraktor pro diskektomii; pravý; 50×20 mm; 17 cm	Discectomy retractor right; 50×20 mm; 17 cm	535
119 91 0326	Retraktor pro diskektomii; pravý; 60×10 mm; 17 cm	Discectomy retractor right; 60×10 mm; 17 cm	535
119 91 0327	Retraktor pro diskektomii; pravý; 60×20 mm; 17 cm	Discectomy retractor right; 60×20 mm; 17 cm	535
119 91 0328	Retraktor pro diskektomii; pravý; 70×10 mm; 17 cm	Discectomy retractor right; 70×10 mm; 17 cm	535
119 91 0329	Retraktor pro diskektomii; pravý; 70×20 mm; 17 cm	Discectomy retractor right; 70×20 mm; 17 cm	535
119 91 0330	Caspar rozvěrač krční komplet	Caspar cervical retractor; complete	536
119 91 0331	Caspar rozvěrač krční	Caspar cervical retractor only	536
119 91 0332	Caspar rozvěrač krční komplet	Caspar cervical retractor; complete	536
119 91 0333	Caspar rozvěrač krční	Caspar cervical retractor only	536
119 91 0334	Caspar rozvěrač krční komplet	Caspar cervical retractor; complete	536
119 91 0335	Caspar rozvěrač krční	Caspar cervical retractor only	536
119 91 0336	Caspar lopatka mediální; 40×23 mm	Caspar blade; medial; 40×23 mm	536; 537
119 91 0337	Caspar lopatka mediální; 45×23 mm	Caspar blade; medial; 45×23 mm	536; 537
119 91 0338	Caspar lopatka mediální; 50×23 mm	Caspar blade; medial; 50×23 mm	536; 537
119 91 0339	Caspar lopatka mediální; 55×23 mm	Caspar blade; medial; 55×23 mm	536; 537
119 91 0340	Caspar lopatka mediální; 60×23 mm	Caspar blade; medial; 60×23 mm	536; 537
119 91 0341	Caspar lopatka laterální; 40×23 mm	Caspar blade; lateral; 40×23 mm	536; 537
119 91 0342	Caspar lopatka laterální; 45×23 mm	Caspar blade; lateral; 45×23 mm	536; 537
119 91 0343	Caspar lopatka laterální; 50×23 mm	Caspar blade; lateral; 50×23 mm	536; 537
119 91 0344	Caspar lopatka laterální; 55×23 mm	Caspar blade; lateral; 55×23 mm	536; 537
119 91 0345	Caspar lopatka laterální; 60×23 mm	Caspar blade; lateral; 60×23 mm	536; 537
119 91 0346	Caspar lopatka; 45×23 mm	Caspar blade; 45×23 mm	536; 537
119 91 0347	Caspar lopatka; 50×23 mm	Caspar blade; 50×23 mm	536; 537
119 91 0348	Caspar lopatka; 55×23 mm	Caspar blade; 55×23 mm	536; 537
119 91 0349	Caspar lopatka; 60×23 mm	Caspar blade; 60×23 mm	536; 537
119 91 0350	Caspar lopatka; 65×23 mm	Caspar blade; 65×23 mm	536; 537
119 91 0351	Caspar lopatka; 50×25 mm	Caspar blade; 50×25 mm	537
119 91 0352	Caspar lopatka; 60×25 mm	Caspar blade; 60×25 mm	537
119 91 0353	Pinzeta pro výměnu lopatek; 11,5 cm	Forceps for changing blades; 11.5 cm	537
119 91 0354	Caspar rozvěrač krční komplet	Caspar cervical retractor; complete	538
119 91 0355	Caspar rozvěrač krční	Caspar cervical retractor only	538
119 91 0356	Klíč pro rozvěrač Caspar	Key for Caspar retractor	538
119 91 0357	Caspar hák; 38 mm	Caspar hook; 38 mm	538
119 91 0358	Caspar hák; 58 mm	Caspar hook; 58 mm	538
119 91 0359	Caspar lopatka; 32×22 mm	Caspar blade; 32×22 mm	538
119 91 0360	Caspar lopatka; 37×22 mm	Caspar blade; 37×22 mm	538
119 91 0361	Caspar lopatka; 43×22 mm	Caspar blade; 43×22 mm	538
119 91 0362	Caspar lopatka; 47×22 mm	Caspar blade; 47×22 mm	538
119 91 0363	Caspar lopatka; 52×22 mm	Caspar blade; 52×22 mm	538
119 91 0364	Caspar lopatka; 57×22 mm	Caspar blade; 57×22 mm	538
119 91 0365	Caspar lopatka; 62×22 mm	Caspar blade; 62×22 mm	538
119 91 0366	Caspar lopatka; 67×22 mm	Caspar blade; 67×22 mm	538
119 91 0367	Caspar lopatka; 32×37 mm	Caspar blade; 32×37 mm	538
119 91 0368	Caspar lopatka; 37×37 mm	Caspar blade; 37×37 mm	538
119 91 0369	Caspar lopatka; 43×37 mm	Caspar blade; 43×37 mm	538
119 91 0370	Caspar lopatka; 47×37 mm	Caspar blade; 47×37 mm	538
119 91 0371	Caspar lopatka; 52×37 mm	Caspar blade; 52×37 mm	538
119 91 0372	Caspar lopatka; 57×37 mm	Caspar blade; 57×37 mm	538
119 91 0373	Caspar lopatka; 62×37 mm	Caspar blade; 62×37 mm	538
119 91 0374	Caspar lopatka; 67×37 mm	Caspar blade; 67×37 mm	538
119 91 0375	Caspar lopatka; 32×52 mm	Caspar blade; 32×52 mm	538
119 91 0376	Caspar lopatka; 37×52 mm	Caspar blade; 37×52 mm	538
119 91 0377	Caspar lopatka; 43×52 mm	Caspar blade; 43×52 mm	538
119 91 0378	Caspar lopatka; 47×52 mm	Caspar blade; 47×52 mm	538
119 91 0379	Caspar lopatka; 52×52 mm	Caspar blade; 52×52 mm	538
119 91 0380	Caspar lopatka; 57×52 mm	Caspar blade; 57×52 mm	538
119 91 0381	Caspar lopatka; 62×52 mm	Caspar blade; 62×52 mm	538
119 91 0382	Caspar lopatka; 67×52 mm	Caspar blade; 67×52 mm	538
119 91 0383	Caspar rozvěrač; 40 mm	Caspar retractor; 40 mm	539
119 91 0384	Caspar rozvěrač; 45 mm	Caspar retractor; 45 mm	539
119 91 0385	Caspar rozvěrač; 50 mm	Caspar retractor; 50 mm	539
119 91 0386	Caspar rozvěrač; 55 mm	Caspar retractor; 55 mm	539
119 91 0387	Caspar rozvěrač; 60 mm	Caspar retractor; 60 mm	539
119 91 0392	Caspar rozvěrač komplet	Caspar retractor complete	539
119 91 0393	Caspar rozvěrač	Caspar retractor only	539
119 91 0394	Caspar lopatka; 35 mm	Caspar blade; 35 mm	539

číslo – number	název	item	strana – page
119 91 0395	Caspar lopatka; 40 mm	Caspar blade; 40 mm	539
119 91 0396	Caspar lopatka; 45 mm	Caspar blade; 45 mm	539
119 91 0397	Caspar lopatka; 50 mm	Caspar blade; 50 mm	539
119 91 0398	Caspar lopatka; 55 mm	Caspar blade; 55 mm	539
119 91 0399	Caspar lopatka; 60 mm	Caspar blade; 60 mm	539
119 91 0400	Scoville-Haverfield rozvěrač komplet	Scoville-Haverfield retractor	540
119 91 0401	Scoville-Haverfield rozvěrač	Scoville-Haverfield retractor only	540
119 91 0402	Scoville lopatka; 5,5 cm	Scoville blade; 5.5 cm	540
119 91 0403	Scoville lopatka; 63x25 mm	Scoville blade; 63x25mm	540
119 91 0404	Scoville lopatka; 63x51 mm	Scoville blade; 63x51mm	540
119 91 0405	Scoville lopatka; 67x32 mm	Scoville blade; 67x32mm	540
119 91 0406	Scoville lopatka; 89x25 mm	Scoville blade; 89x25mm	540
119 91 0407	Taylor lopatka; 47x37 mm	Taylor blade; 47x37mm	540
119 91 0408	Taylor lopatka; 63x51 mm	Taylor blade; 63x51mm	540
119 91 0409	Scoville-Richter rozvěrač komplet	Scoville-Richter retractor complete	541
119 91 0410	Scoville-Richter rozvěrač	Scoville-Richter retractor	541
119 91 0411	Scoville-Richter lopatka; pár	Scoville-Richter blades; pair	541
119 91 0412	Scoville-Richter lopatka; 47x51 mm	Scoville-Richter blade; 47x51 mm	541
119 91 0413	Scoville-Richter lopatka; 30x40 mm	Scoville-Richter blade; 30x40 mm	541
119 91 0414	Scoville-Richter lopatka; 37x62 mm	Scoville-Richter blade; 37x62 mm	541
119 91 0415	Cloward modif. rozvěrač komplet	Cloward modif. retractor with 5 blades	542
119 91 0416	Cloward modif. rozvěrač; 25 cm	Cloward modif. retractor only; 25 cm	542
119 91 0417	Cloward-modif. lopatka se zuby; 40x16 mm	Cloward-modif. blade; with teeth; 40x16 mm	542
119 91 0418	Cloward-modif. lopatka se zuby; 45x16 mm	Cloward-modif. blade; with teeth; 45x16 mm	542
119 91 0419	Cloward-modif. lopatka se zuby; 50x16 mm	Cloward-modif. blade; with teeth; 50x16 mm	542
119 91 0420	Cloward-modif. lopatka se zuby; 55x16 mm	Cloward-modif. blade; with teeth; 55x16 mm	542
119 91 0421	Cloward-modif. lopatka se zuby; 60x16 mm	Cloward-modif. blade; with teeth; 60x16 mm	542
119 91 0422	Cloward-modif. lopatka; 40x16 mm	Cloward-modif. blade; 40x16 mm	542
119 91 0423	Cloward-modif. lopatka; 45x16 mm	Cloward-modif. blade; 45x16 mm	542
119 91 0424	Cloward-modif. lopatka; 50x16 mm	Cloward-modif. blade; 50x16 mm	542
119 91 0425	Cloward-modif. lopatka; 55x16 mm	Cloward-modif. blade; 55x16 mm	542
119 91 0426	Cloward-modif. lopatka; 60x16 mm	Cloward-modif. blade; 60x16 mm	542
119 91 0427	Rozvěrač komplet	Retractor with 5 blades	542
119 91 0428	Rozvěrač	Retractor only	542
119 91 0429	Cloward rozvěrač plotének; 50 mm	Cloward lamina spreader; 50 mm	543
119 91 0430	Cloward rozvěrač plotének; 75 mm	Cloward lamina spreader; 75 mm	543
119 91 0431	Cloward rozvěrač plotének; 90 mm	Cloward lamina spreader; 9.0 cm	543
119 91 0432	Cloward rozvěrač plotének; 110 mm	Cloward lamina spreader; 11.0 cm	543
119 91 0433	Cloward rozvěrač plotének; 7x110 mm	Cloward lamina spreader; 7x110mm	543
119 91 0434	Harms rozvěrač plotének pravý	Harms lamina spreader; right	544
119 91 0435	Harms rozvěrač plotének levý	Harms lamina spreader; left	544
119 91 0436	Cloward rozvěrač plotének; 16,0 cm	Cloward lamina spreader; 16 cm	544
119 91 0437	Inge rozvěrač plotének; 16,5 cm	Inge lamina spreader 16.5 cm	545
119 91 0438	Inge rozvěrač plotének; 10mm; 27 cm	Inge lamina spreader; 10 mm; 27 cm	545
121 08 0050	Lopatka břišní ohebná; 40 mm; 33,0 cm	Abdominal spatula malleable; 40 mm; 33.0 cm	253
121 08 0100	Lopatka na mast s výřezem; 13x16 mm; 14,0 cm	Unguent spatula; 13x16 mm; 14.0 cm	254
121 22 0010	Tuffier lopatka na ledviny ohebná; 16x23 mm; 20,0 cm	Tuffier kidney spatula malleable; 16x23 mm; 20.0 cm	254
121 31 0010	Buchwald lopatka na jazyk; 16x23 mm; 17,3 cm	Buchwald tongue spatula; 16x23 mm; 17.3 cm	400
121 31 0020	Bruenings lopatka na jazyk; 14x18 mm; 19,5 cm	Bruenings tongue spatula; 14x18 mm; 19.5 cm	400; 434
121 38 0010	Jaeger destička na víčkové operace; 11,0 cm	Jaeger eye lid plate; 11.0 cm	254
121 91 0012	Reverdin lopatka břišní; 45x60 mm; 29,0 cm	Reverdin abdominal spatula; 45x60 mm; 29.0 cm	253
121 91 0013	Simplex držák na tváře; 11,0 cm	Simplex cheek retractor; 11.0 cm	399
121 91 0014	Tobold držák jazyka; 14,5 cm	Tobold tongue depressor hollow; 14.5 cm	399
121 91 0016	Moritz-Schmidt držák jazyka; 19,0 cm	Moritz-Schmidt tongue depressor; 19.0 cm	399
121 91 0017	Wieder držák na jazyk fig.1; 14,0 cm	Wieder tongue depressor fig.1; 14.0 cm	399
121 91 0018	Wieder držák na jazyk fig.2; 14,5 cm	Wieder tongue depressor fig.2; 14.5 cm	399
121 91 0020	Standard držák jazyka; 14,5 cm	Standard tongue depressor; 14.5 cm	400
121 91 0022	Kroenig držák jazyka; 15,0 cm	Kroenig tongue depressor; 15.0 cm	400
121 91 0023	Mayo držák jazyka; 17,0 cm	Mayo tongue depressor; 17.0 cm	400; 433
121 91 0024	Bruenings držák jazyka; 19,0 cm	Bruenings tongue depressor; 19.0 cm	400
121 91 0026	Lopatka na jazyk; 18,0 cm	Tongue spatula; 18.0 cm	400
121 91 0027	Allison lopatka na plíce; 26,0 cm	Allison lung spatula; 26.0 cm	253
121 91 0028	Allison lopatka na plíce; 32,0 cm	Allison lung spatula; 32.0 cm	253
122 91 0001	Cusco zrcadlo poševní; 75x32 mm	Cusco vaginal speculum; 75x32 mm	472
122 91 0002	Cusco zrcadlo poševní; 85x35 mm	Cusco vaginal speculum; 85x35 mm	472
122 91 0003	Cusco zrcadlo poševní; 100x35 mm	Cusco vaginal speculum; 100x35 mm	472
122 91 0004	Cusco-virgin zrcadlo poševní; 75x17 mm	Cusco-Virgin vaginal speculum; 75x17 mm	472
122 91 0005	Cusco-suisse zrcadlo poševní; 80x22 mm	Cusco-Suisse vaginal speculum; 80x22 mm	472
122 91 0006	Cusco-suisse zrcadlo poševní; 100x25 mm	Cusco-Suisse vaginal speculum; 100x25 mm	472
122 91 0007	Cusco-suisse zrcadlo poševní; 105x27 mm	Cusco-Suisse vaginal speculum; 105x27 mm	472
122 91 0008	Cusco zrcadlo poševní; 74x32 mm	Cusco vaginal speculum; 74x32 mm	472
122 91 0009	Cusco zrcadlo poševní; 85x35 mm	Cusco vaginal speculum; 85x35 mm	472
122 91 0010	Cusco zrcadlo poševní; 100x37 mm	Cusco vaginal speculum; 100x37 mm	472
122 91 0011	Collin zrcadlo poševní; 85x30 mm	Collin vaginal speculum; 85x30 mm	473
122 91 0012	Collin zrcadlo poševní; 100x35 mm	Collin vaginal speculum; 100x35 mm	473
122 91 0013	Collin zrcadlo poševní; 110x40 mm	Collin vaginal speculum; 110x40 mm	473
122 91 0014	Pederson zrcadlo poševní; 75x13 mm	Pederson vaginal speculum; 75x13 mm	473
122 91 0015	Pederson zrcadlo poševní; 100x22 mm	Pederson vaginal speculum; 100x22 mm	473
122 91 0016	Pederson zrcadlo poševní; 120x25 mm	Pederson vaginal speculum; 120x25 mm	473
122 91 0017	Grave zrcadlo poševní; 75x20 mm	Grave vaginal speculum; 75x20 mm	473
122 91 0018	Grave zrcadlo poševní; 95x35 mm	Grave vaginal speculum; 95x35 mm	473
122 91 0019	Grave zrcadlo poševní; 115x35 mm	Grave vaginal speculum; 115x35 mm	473
122 91 0020	Nott zrcadlo poševní; 90x30 mm	Nott vaginal speculum; 90x30 mm	473
122 91 0021	Nott zrcadlo poševní; 110x30 mm	Nott vaginal speculum; 110x30 mm	473

číslo – number	název	item	strana – page
122 91 0022	Semm zrcadlo poševní; 90×14/18 mm	Semm vaginal speculum; 90×14/18 mm	474
122 91 0023	Semm zrcadlo poševní; 100×17/20 mm	Semm vaginal speculum; 100×17/20 mm	474
122 91 0024	Semm zrcadlo poševní; 100×25/30 mm	Semm vaginal speculum; 100×25/30 mm	474
122 91 0025	Seyffert zrcadlo poševní; 100×17 mm	Seyffert vaginal speculum; 100×17 mm	474
122 91 0026	Seyffert zrcadlo poševní; 110×33 mm	Seyffert vaginal speculum; 110×33 mm	474
122 91 0027	Seyffert zrcadlo poševní; 110×33 mm	Seyffert vaginal speculum; 110×33 mm	474
122 91 0028	Grave zrcadlo vaginální s trubičkou; 76×13 mm	Grave vaginal speculum with suction tube; 76×13 mm	475
122 91 0030	Grave zrcadlo vaginální s trubičkou; 101×22 mm	Grave vaginal speculum with suction tube; 101×22 mm	475
122 91 0032	Grave zrcadlo vaginální s trubičkou; 120×35 mm	Grave vaginal speculum with suction tube; 120×35 mm	475
122 91 0034	Grave zrcadlo vaginální s trubičkou; 76×13 mm	Grave vaginal speculum with suction tube; 76×13 mm	475
122 91 0036	Grave zrcadlo vaginální s trubičkou; 101×22 mm	Grave vaginal speculum with suction tube; 101×22 mm	475
122 91 0038	Grave zrcadlo vaginální s trubičkou; 120×35 mm	Grave vaginal speculum with suction tube; 120×35 mm	475
122 91 0040	Grave zrcadlo vaginální s trubičkou; 76×13 mm	Grave vaginal speculum with suction tube; 76×13 mm	475
122 91 0042	Grave zrcadlo vaginální s trubičkou; 101×22 mm	Grave vaginal speculum with suction tube; 101×22 mm	475
122 91 0044	Grave zrcadlo vaginální s trubičkou; 120×35 mm	Grave vaginal speculum with suction tube; 120×35 mm	475
122 91 0046	Grave special zrcadlo se sací trubičkou; 135°	Grave special vaginal speculum with suction tube; 135°	476
122 91 0048	Grave special zrcadlo se sací trubičkou	Grave special vaginal speculum with suction tube	476
122 91 0050	Grave special zrcadlo se sací trubičkou; 135°	Grave special vaginal speculum with suction tube; 135°	476
122 91 0052	Grave special zrcadlo se sací trubičkou; 135°	Grave special vaginal speculum with suction tube; 135°	476
122 91 0054	Grave special zrcadlo se sací trubičkou	Grave special vaginal speculum with suction tube	476
122 91 0056	Grave special zrcadlo se sací trubičkou; 135°	Grave special vaginal speculum with suction tube; 135°	476
122 91 0058	Grave special zrcadlo se sací trubičkou; 135°	Grave special vaginal speculum with suction tube; 135°	476
122 91 0060	Grave special zrcadlo se sací trubičkou	Grave special vaginal speculum with suction tube	476
122 91 0062	Grave special zrcadlo se sací trubičkou; 135°	Grave special vaginal speculum with suction tube; 135°	476
122 91 0064	Pederson zrcadlo se sací trubičkou; 76×13 mm	Pederson vaginal speculum with suction tube; 76×13 mm	477
122 91 0066	Pederson zrcadlo se sací trubičkou; 101×22 mm	Pederson vaginal speculum with suction tube; 101×22 mm	477
122 91 0068	Pederson zrcadlo se sací trubičkou; 120×25 mm	Pederson vaginal speculum with suction tube; 120×25 mm	477
122 91 0070	Pederson zrcadlo se sací trubičkou; 76×13 mm	Pederson vaginal speculum with suction tube; 76×13 mm	477
122 91 0072	Pederson zrcadlo se sací trubičkou; 101×22 mm	Pederson vaginal speculum with suction tube; 101×22 mm	477
122 91 0074	Pederson zrcadlo se sací trubičkou; 120×25 mm	Pederson vaginal speculum with suction tube; 120×25 mm	477
122 91 0076	Pederson zrcadlo se sací trubičkou; 76×13 mm	Pederson vaginal speculum with suction tube; 76×13 mm	477
122 91 0078	Pederson zrcadlo se sací trubičkou; 101×22 mm	Pederson vaginal speculum with suction tube; 101×22 mm	477
122 91 0080	Pederson zrcadlo se sací trubičkou; 120×25 mm	Pederson vaginal speculum with suction tube; 120×25 mm	477
122 91 0082	Cusco zrcadlo se sací trubičkou; 105×25 mm	Cusco vaginal speculum with suction tube; 105×25 mm	477
122 91 0083	Cusco zrcadlo se sací trubičkou; 107×29 mm	Cusco vaginal speculum with suction tube; 107×29 mm	477
122 91 0084	Cusco zrcadlo se sací trubičkou; 115×35 mm	Cusco vaginal speculum with suction tube; 115×35 mm	477
122 91 0085	Cusco zrcadlo se sací trubičkou; 105×25 mm	Cusco vaginal speculum with suction tube; 105×25 mm	477
122 91 0086	Cusco zrcadlo se sací trubičkou; 107×29 mm	Cusco vaginal speculum with suction tube; 107×29 mm	477
122 91 0087	Cusco zrcadlo se sací trubičkou; 115×35 mm	Cusco vaginal speculum with suction tube; 115×35 mm	477
122 91 0088	Cusco zrcadlo se sací trubičkou; 105×25 mm	Cusco vaginal speculum with suction tube; 105×25 mm	477
122 91 0089	Cusco zrcadlo se sací trubičkou; 107×29 mm	Cusco vaginal speculum with suction tube; 107×29 mm	477
122 91 0090	Cusco zrcadlo se sací trubičkou; 115×35 mm	Cusco vaginal speculum with suction tube; 115×35 mm	477
122 91 0091	Sims zrcadlo poševní dvojité; 60×25/30 mm	Sims vaginal speculum - double; 60×25/30 mm	469
122 91 0092	Sims zrcadlo poševní dvojité; 70×30/35 mm	Sims vaginal speculum - double; 70×30/35 mm	469
122 91 0093	Sims zrcadlo poševní dvojité; 80×35/40 mm	Sims vaginal speculum - double; 80×35/40 mm	469
122 91 0094	Kristeller zrcadlo poševní fig. 1; 70×27 mm	Kristeller vaginal speculum fig. 1; 70×27 mm	468
122 91 0095	Kristeller zrcadlo poševní fig. 2; 80×30 mm	Kristeller vaginal speculum fig. 2; 80×30 mm	468
122 91 0096	Kristeller zrcadlo poševní fig. 3; 90×36 mm	Kristeller vaginal speculum fig. 3; 90×36 mm	468
122 91 0097	Kristeller zrcadlo poševní fig. 1; 75×23 mm	Kristeller vaginal speculum fig. 1; 75×23 mm	468
122 91 0098	Kristeller zrcadlo poševní fig. 2; 85×26 mm	Kristeller vaginal speculum fig. 2; 85×26 mm	468
122 91 0099	Kristeller zrcadlo poševní fig. 3; 100×32 mm	Kristeller vaginal speculum fig. 3; 100×32 mm	468
122 91 0100	Kristeller zrcadlo poševní sada fig. 1	Kristeller vaginal specula set fig. 1	468
122 91 0101	Kristeller zrcadlo poševní sada fig. 2	Kristeller vaginal specula set fig. 2	468
122 91 0102	Kristeller zrcadlo poševní sada fig. 3	Kristeller vaginal specula set fig. 3	468
122 91 0103	Kristeller zrcadlo poševní fig. 00; 105×18 mm	Kristeller vaginal speculum fig. 00; 105×18 mm	468
122 91 0104	Kristeller zrcadlo poševní fig. 0; 105×21 mm	Kristeller vaginal speculum fig. 0; 105×21 mm	468
122 91 0105	Kristeller zrcadlo poševní fig. 00; 110×14 mm	Kristeller vaginal speculum fig. 00; 110×14 mm	468
122 91 0106	Kristeller zrcadlo poševní fig. 0; 110×17 mm	Kristeller vaginal speculum fig. 0; 110×17 mm	468
122 91 0107	Kristeller zrcadlo poševní sada fig. 00	Kristeller vaginal specula set fig. 00	468
122 91 0108	Kristeller zrcadlo poševní sada fig. 0	Kristeller vaginal specula set fig. 0	468
122 91 0109	Kristeller zrcadlo poševní fig. 1; 105×26 mm	Kristeller vaginal speculum fig. 1; 105×26 mm	468
122 91 0110	Kristeller zrcadlo poševní fig. 2; 105×28 mm	Kristeller vaginal speculum fig. 2; 105×28 mm	468
122 91 0111	Kristeller zrcadlo poševní fig. 3; 105×33 mm	Kristeller vaginal speculum fig. 3; 105×33 mm	468
122 91 0112	Kristeller zrcadlo poševní fig. 1; 115×22 mm	Kristeller vaginal speculum fig. 1; 115×22 mm	468
122 91 0113	Kristeller zrcadlo poševní fig. 2; 115×24 mm	Kristeller vaginal speculum fig. 2; 115×24 mm	468
122 91 0114	Kristeller zrcadlo poševní fig. 3; 115×29 mm	Kristeller vaginal speculum fig. 3; 115×29 mm	468
122 91 0115	Kristeller zrcadlo poševní sada fig. 1	Kristeller vaginal specula set fig. 1	468
122 91 0116	Kristeller zrcadlo poševní sada fig. 2	Kristeller vaginal specula set fig. 2	468
122 91 0117	Kristeller zrcadlo poševní sada fig. 3	Kristeller vaginal specula set fig. 3	468
122 91 0118	Kristeller zrcadlo poševní fig. 1; 110×27 mm	Kristeller vaginal speculum fig. 1; 110×27 mm	468
122 91 0119	Kristeller zrcadlo poševní fig. 2; 110×30 mm	Kristeller vaginal speculum fig. 2; 110×30 mm	468
122 91 0120	Kristeller zrcadlo poševní fig. 3; 110×36 mm	Kristeller vaginal speculum fig. 3; 110×36 mm	468
122 91 0121	Kristeller zrcadlo poševní fig. 1; 115×23 mm	Kristeller vaginal speculum fig. 1; 115×23 mm	468
122 91 0122	Kristeller zrcadlo poševní fig. 2; 115×26 mm	Kristeller vaginal speculum fig. 2; 115×26 mm	468
122 91 0123	Kristeller zrcadlo poševní fig. 3; 115×32 mm	Kristeller vaginal speculum fig. 3; 115×32 mm	468
122 91 0124	Kristeller zrcadlo poševní sada fig. 1	Kristeller vaginal specula set fig. 1	468
122 91 0125	Kristeller zrcadlo poševní sada fig. 2	Kristeller vaginal specula set fig. 2	468
122 91 0126	Kristeller zrcadlo poševní sada fig. 3	Kristeller vaginal specula set fig. 3	468
122 91 0127	Doyen zrcadlo poševní; 55×35 mm	Doyen vaginal speculum sl. concave; 55×35 mm	470
122 91 0128	Doyen zrcadlo poševní; 85×35 mm	Doyen vaginal speculum sl. concave; 85×35 mm	470
122 91 0129	Doyen zrcadlo poševní; 115×35 mm	Doyen vaginal speculum sl. concave; 115×35 mm	470
122 91 0130	Doyen zrcadlo poševní; 55×45 mm	Doyen vaginal speculum sl. concave; 55×45 mm	470
122 91 0131	Doyen zrcadlo poševní; 85×45 mm	Doyen vaginal speculum sl. concave; 85×45 mm	470
122 91 0132	Doyen zrcadlo poševní; 115×45 mm	Doyen vaginal speculum sl. concave; 115×45 mm	470



číslo – number	název	item	strana – page
122 91 0133	Doyen zrcadlo poševní; 55×60 mm	Doyen vaginal speculum sl. concave; 55×60 mm	470
122 91 0134	Doyen zrcadlo poševní; 85×60 mm	Doyen vaginal speculum sl. concave; 85×60 mm	470
122 91 0135	Doyen zrcadlo poševní; 115×60 mm	Doyen vaginal speculum sl. concave; 115×60 mm	470
122 91 0136	Scherback zrcadlo poševní komplet	Scherback vaginal specula set complete	470
122 91 0137	Lžice pro zrcadlo Scherback	Blade only for Scherback speculum	470
122 91 0138	Lžice pro zrcadlo Scherback	Blade only for Scherback speculum	470
122 91 0139	Lžice pro zrcadlo Scherback	Blade only for Scherback speculum	470
122 91 0140	Lžice pro zrcadlo Scherback	Blade only for Scherback speculum	470
122 91 0141	Lžice pro zrcadlo Scherback	Blade only for Scherback speculum	470
122 91 0142	Držadlo pro zrcadlo Scherback	Handle only for Scherback speculum	470
122 91 0143	Závaží pro zrcadlo Scherback; 400g	Weight only for Scherback speculum; 400g	470
122 91 0144	Závaží pro zrcadlo Scherback; 800g	Weight only for Scherback speculum; 800g	470
122 91 0145	Scherback zrcadlo poševní komplet	Scherback vaginal specula set	470
122 91 0146	Auvar d zrcadlo poševní; 80×38 mm	Auvar d vaginal speculum; 80×38 mm	471
122 91 0147	Auvar d zrcadlo poševní; 102×45 mm	Auvar d vaginal speculum; 102×45 mm	471
122 91 0148	New port páka laterální poševní; 25,0 cm	New port vaginal retractor; 25.0 cm	479
122 91 0149	Breisky zrcadlo poševní bajonetové; 100×20 mm	Breisky vaginal speculum; 100×20 mm	471
122 91 0150	Breisky zrcadlo poševní bajonetové; 100×25 mm	Breisky vaginal speculum; 100×25 mm	471
122 91 0151	Breisky zrcadlo poševní bajonetové; 100×30 mm	Breisky vaginal speculum; 100×30 mm	471
122 91 0152	Breisky zrcadlo poševní bajonetové; 100×35 mm	Breisky vaginal speculum; 100×35 mm	471
122 91 0153	Breisky zrcadlo poševní bajonetové; 100×40 mm	Breisky vaginal speculum; 100×40 mm	471
122 91 0154	Breisky zrcadlo poševní bajonetové; 130×20 mm	Breisky vaginal speculum; 130×20 mm	471
122 91 0155	Breisky zrcadlo poševní bajonetové; 130×25 mm	Breisky vaginal speculum; 130×25 mm	471
122 91 0156	Breisky zrcadlo poševní bajonetové; 130×30 mm	Breisky vaginal speculum; 130×30 mm	471
122 91 0157	Breisky zrcadlo poševní bajonetové; 130×35 mm	Breisky vaginal speculum; 130×35 mm	471
122 91 0158	Breisky zrcadlo poševní bajonetové; 130×40 mm	Breisky vaginal speculum; 130×40 mm	471
122 91 0159	Breisky zrcadlo poševní bajonetové; 155×40 mm	Breisky vaginal speculum; 155×40 mm	471
122 91 0160	Landau zrcadlo poševní bajonetové; 105×28 mm	Landau vaginal speculum; 105×28 mm	471
122 91 0161	Landau zrcadlo poševní bajonetové; 105×38 mm	Landau vaginal speculum; 105×38 mm	471
122 91 0162	O'Sullivan-O'Connor rozvěrač komplet	O'Sullivan-O'Connor retractor complete	479
122 91 0163	Rám pro O'Sullivan-O'Connor	Frame for retractor O'Sullivan-O'Connor	479
122 91 0164	Lopatka pro O'Sullivan-O'Connor; 45×17 mm	Blade for retractor O'Sullivan-O'Connor; 45×17 mm	479
122 91 0165	Lopatka pro O'Sullivan-O'Connor; 90×37 mm	Blade for retractor O'Sullivan-O'Connor; 90×37 mm	479
122 91 0166	Lopatka pro O'Sullivan-O'Connor; 90×45 mm	Blade for retractor O'Sullivan-O'Connor; 90×45 mm	479
122 91 0168	Kogan endozrcadlo; 24,0 cm	Kogan endospeculum; 24.0 cm	478
122 91 0169	Kogan endozrcadlo se západkou; 24,0 cm	Kogan endospeculum; 24.0 cm	478
122 91 0170	Kogan endozrcadlo 3 mm; 24,0 cm	Kogan endospeculum 3 mm; 24.0 cm	478
122 91 0171	Kogan endozrcadlo 7 mm; 24,0 cm	Kogan endospeculum 7 mm; 24.0 cm	478
122 91 0172	Držátko zrcátek hrtanových	Handle for laryngeal mirrors	406
122 91 0173	Zrcátko hrtanové bez držátka fig.00; 8 mm	Laryngeal mirror w/o handle fig.00; 8 mm	406
122 91 0174	Zrcátko hrtanové bez držátka fig.0; 10 mm	Laryngeal mirror w/o handle fig.0; 10 mm	406
122 91 0175	Zrcátko hrtanové bez držátka fig.1; 12 mm	Laryngeal mirror w/o handle fig.1; 12 mm	406
122 91 0176	Zrcátko hrtanové bez držátka fig.2; 14 mm	Laryngeal mirror w/o handle fig.2; 14 mm	406
122 91 0177	Zrcátko hrtanové bez držátka fig.3; 16 mm	Laryngeal mirror w/o handle fig.3; 16 mm	406
122 91 0178	Zrcátko hrtanové bez držátka fig.4; 18 mm	Laryngeal mirror w/o handle fig.4; 18 mm	406
122 91 0179	Zrcátko hrtanové bez držátka fig.5; 20 mm	Laryngeal mirror w/o handle fig.5; 20 mm	406
122 91 0180	Zrcátko hrtanové bez držátka fig.6; 22 mm	Laryngeal mirror w/o handle fig.6; 22 mm	406
122 91 0181	Zrcátko hrtanové bez držátka fig.7; 24 mm	Laryngeal mirror w/o handle fig.7; 24 mm	406
122 91 0182	Zrcátko hrtanové bez držátka fig.8; 26 mm	Laryngeal mirror w/o handle fig.8; 26 mm	406
122 91 0183	Zrcátko hrtanové bez držátka fig.9; 28 mm	Laryngeal mirror w/o handle fig.9; 28 mm	406
122 91 0184	Zrcátko hrtanové bez držátka fig.10; 30 mm	Laryngeal mirror w/o handle fig.10; 30 mm	406
122 91 0185	Zrcátko hrtanové s držátkem fig.00; 8 mm	Laryngeal mirror w/handle fig.00; 8 mm	406
122 91 0186	Zrcátko hrtanové s držátkem fig.0; 10 mm	Laryngeal mirror w/handle fig.0; 10 mm	406
122 91 0187	Zrcátko hrtanové s držátkem fig.1; 12 mm	Laryngeal mirror w/handle fig.1; 12 mm	406
122 91 0188	Zrcátko hrtanové s držátkem fig.2; 14 mm	Laryngeal mirror w/handle fig.2; 14 mm	406
122 91 0189	Zrcátko hrtanové s držátkem fig.3; 16 mm	Laryngeal mirror w/handle fig.3; 16 mm	406
122 91 0190	Zrcátko hrtanové s držátkem fig.4; 18 mm	Laryngeal mirror w/handle fig.4; 18 mm	406
122 91 0191	Zrcátko hrtanové s držátkem fig.5; 20 mm	Laryngeal mirror w/handle fig.5; 20 mm	406
122 91 0192	Zrcátko hrtanové s držátkem fig.6; 22 mm	Laryngeal mirror w/handle fig.6; 22 mm	406
122 91 0193	Zrcátko hrtanové s držátkem fig.7; 24 mm	Laryngeal mirror w/handle fig.7; 24 mm	406
122 91 0194	Zrcátko hrtanové s držátkem fig.8; 26 mm	Laryngeal mirror w/handle fig.8; 26 mm	406
122 91 0195	Zrcátko hrtanové s držátkem fig.9; 28 mm	Laryngeal mirror w/handle fig.9; 28 mm	406
122 91 0196	Zrcátko hrtanové s držátkem fig.10; 30 mm	Laryngeal mirror w/handle fig.10; 30 mm	406
122 91 0200	Politzer zrcátko ušní sada fig.1-3	Politzer ear speculum set fig.1-3	401
122 91 0201	Politzer zrcátko ušní fig.1; 2,0 mm	Politzer ear speculum fig.1; 2.0 mm	401
122 91 0202	Politzer zrcátko ušní fig.2; 3,0 mm	Politzer ear speculum fig.2; 3.0 mm	401
122 91 0203	Politzer zrcátko ušní fig.3; 4,0 mm	Politzer ear speculum fig.3; 4.0 mm	401
122 91 0204	Politzer zrcátko ušní fig.4; 5,0 mm	Politzer ear speculum fig.4; 5.0 mm	401
122 91 0205	Hartmann zrcátko ušní dětské sada fig.0-2	Hartmann f. children set fig.0-2	401
122 91 0206	Hartmann zrcátko ušní fig.0; 2,0 mm	Hartmann ear speculum fig.0; 2.0 mm	401
122 91 0207	Hartmann zrcátko ušní fig.1; 3,5 mm	Hartmann ear speculum fig.1; 3.5 mm	401
122 91 0208	Hartmann zrcátko ušní fig.2; 5,0 mm	Hartmann ear speculum fig.2; 5.0 mm	401
122 91 0209	Hartmann zrcátko ušní fig.3; 6,5 mm	Hartmann ear speculum fig.3; 6.5 mm	401
122 91 0210	Hartmann zrcátko ušní fig.4; 7,5 mm	Hartmann ear speculum fig.4; 7.5 mm	401
122 91 0211	Hartmann zrcátko ušní sada fig.2-4	Hartmann ear speculum set fig.2-4	401
122 91 0212	Hartmann zrcátko ušní sada fig.1-4	Hartmann ear speculum set fig.1-4	401
122 91 0213	Hartmann zrcátko ušní černé fig.0; 3,0 mm	Hartmann ear speculum black fig.0; 3.0 mm	401
122 91 0214	Hartmann zrcátko ušní černé fig.1; 4,0 mm	Hartmann ear speculum black fig.1; 4.0 mm	401
122 91 0215	Hartmann zrcátko ušní černé fig.2; 5,0 mm	Hartmann ear speculum black fig.2; 5.0 mm	401
122 91 0216	Hartmann zrcátko ušní černé fig.3; 7,0 mm	Hartmann ear speculum black fig.3; 7.0 mm	401
122 91 0217	Hartmann zrcátko ušní černé sada fig.0-3	Hartmann ear speculum black set fig.0-3	401
122 91 0218	Toynbee zrcátko ušní sada fig.2-4	Toynbee ear speculum set fig.2-4	401
122 91 0219	Toynbee zrcátko ušní sada fig.1-4	Toynbee ear speculum set fig.1-4	401
122 91 0220	Toynbee zrcátko ušní fig.1	Toynbee ear speculum fig.1	401

číslo – number	název	item	strana – page
122 91 0221	Toynbee zrcátko ušní fig.2	Toynbee ear speculum fig.2	401
122 91 0222	Toynbee zrcátko ušní fig.3	Toynbee ear speculum fig.3	401
122 91 0223	Toynbee zrcátko ušní fig.4	Toynbee ear speculum fig.4	401
122 91 0241	Farrior zrcátko ušní; 3,3 mm	Farrior ear speculum; 3,3 mm	402
122 91 0242	Farrior zrcátko ušní; 4,3 mm	Farrior ear speculum; 4,3 mm	402
122 91 0243	Farrior zrcátko ušní; 4,8 mm	Farrior ear speculum; 4,8 mm	402
122 91 0244	Farrior zrcátko ušní; 5,3 mm	Farrior ear speculum; 5,3 mm	402
122 91 0245	Farrior zrcátko ušní; 5,8 mm	Farrior ear speculum; 5,8 mm	402
122 91 0246	Farrior zrcátko ušní; 6,3 mm	Farrior ear speculum; 6,3 mm	402
122 91 0247	Farrior zrcátko ušní; 6,7 mm	Farrior ear speculum; 6,7 mm	402
122 91 0248	Farrior zrcátko ušní; 7,2 mm	Farrior ear speculum; 7,2 mm	402
122 91 0249	Farrior zrcátko ušní; 7,7 mm	Farrior ear speculum; 7,7 mm	402
122 91 0250	Farrior zrcátko ušní; 3,0×4,0 mm	Farrior ear speculum; 3,0×4,0 mm	402
122 91 0251	Farrior zrcátko ušní; 4,0×5,0 mm	Farrior ear speculum; 4,0×5,0 mm	402
122 91 0252	Farrior zrcátko ušní; 4,5×5,5 mm	Farrior ear speculum; 4,5×5,5 mm	402
122 91 0253	Farrior zrcátko ušní; 5,0×6,0 mm	Farrior ear speculum; 5,0×6,0 mm	402
122 91 0254	Farrior zrcátko ušní; 5,5×6,5 mm	Farrior ear speculum; 5,5×6,5 mm	402
122 91 0255	Farrior zrcátko ušní; 6,0×7,0 mm	Farrior ear speculum; 6,0×7,0 mm	402
122 91 0256	Farrior zrcátko ušní; 6,5×7,5 mm	Farrior ear speculum; 6,5×7,5 mm	402
122 91 0257	Farrior zrcátko ušní; 7,0×8,0 mm	Farrior ear speculum; 7,0×8,0 mm	402
122 91 0258	Farrior zrcátko ušní; 7,5×8,5 mm	Farrior ear speculum; 7,5×8,5 mm	402
122 91 0259	Farrior zrcátko ušní; 3,0×4,0 mm; 20°	Farrior ear speculum; 3,0×4,0 mm; 20°	402
122 91 0260	Farrior zrcátko ušní; 4,0×5,0 mm; 20°	Farrior ear speculum; 4,0×5,0 mm; 20°	402
122 91 0261	Farrior zrcátko ušní; 4,5×5,5 mm; 20°	Farrior ear speculum; 4,5×5,5 mm; 20°	402
122 91 0262	Farrior zrcátko ušní; 5,0×6,0 mm; 20°	Farrior ear speculum; 5,0×6,0 mm; 20°	402
122 91 0263	Farrior zrcátko ušní; 5,5×6,5 mm; 20°	Farrior ear speculum; 5,5×6,5 mm; 20°	402
122 91 0264	Farrior zrcátko ušní; 6,0×7,0 mm; 20°	Farrior ear speculum; 6,0×7,0 mm; 20°	402
122 91 0265	Farrior zrcátko ušní; 6,5×7,5 mm; 20°	Farrior ear speculum; 6,5×7,5 mm; 20°	402
122 91 0266	Farrior zrcátko ušní; 7,0×8,0 mm 20°	Farrior ear speculum; 7,0×8,0 mm 20°	402
122 91 0267	Farrior zrcátko ušní; 7,5×8,5 mm; 20°	Farrior ear speculum; 7,5×8,5 mm; 20°	402
122 91 0268	Farrior zrcátko ušní; 3,0×4,0 mm; 35°	Farrior ear speculum; 3,0×4,0 mm; 35°	402
122 91 0269	Farrior zrcátko ušní; 4,0×5,0 mm; 35°	Farrior ear speculum; 4,0×5,0 mm; 35°	402
122 91 0270	Farrior zrcátko ušní; 4,5×5,5 mm; 35°	Farrior ear speculum; 4,5×5,5 mm; 35°	402
122 91 0271	Farrior zrcátko ušní; 5,0×6,0 mm; 35°	Farrior ear speculum; 5,0×6,0 mm; 35°	402
122 91 0272	Farrior zrcátko ušní; 5,5×6,5 mm; 35°	Farrior ear speculum; 5,5×6,5 mm; 35°	402
122 91 0273	Farrior zrcátko ušní; 6,0×7,0 mm; 35°	Farrior ear speculum; 6,0×7,0 mm; 35°	402
122 91 0274	Farrior zrcátko ušní; 6,5×7,5 mm; 35°	Farrior ear speculum; 6,5×7,5 mm; 35°	402
122 91 0275	Farrior zrcátko ušní; 7,0×8,0 mm; 35°	Farrior ear speculum; 7,0×8,0 mm; 35°	402
122 91 0276	Farrior zrcátko ušní; 7,5×8,5 mm; 35°	Farrior ear speculum; 7,5×8,5 mm; 35°	402
122 91 0277	Bruenings otoskop komplet	Bruenings otoscope complete	403
122 91 0278	Bruenings zrcátko ušní fig.00; 2,0/4,0 mm	Bruenings ear speculum fig.00; 2,0/4,0 mm	403
122 91 0279	Bruenings zrcátko ušní fig.0; 3,0/4,8 mm	Bruenings ear speculum fig.0; 3,0/4,8 mm	403
122 91 0280	Bruenings zrcátko ušní fig.1; 4,0/6,0 mm	Bruenings ear speculum fig.1; 4,0/6,0 mm	403
122 91 0281	Bruenings zrcátko ušní fig.2; 5,0/7,0 mm	Bruenings ear speculum fig.2; 5,0/7,0 mm	403
122 91 0282	Bruenings zrcátko ušní fig.3; 6,5×8,5 mm	Bruenings ear speculum fig.3; 6,5×8,5 mm	403
122 91 0283	Bruenings zrcátko ušní fig.4; 8,5×10,5 mm	Bruenings ear speculum fig.4; 8,5×10,5 mm	403
122 91 0284	Bruenings zrcátko ušní fig.5; 10,5×12,5 mm	Bruenings ear speculum fig.5; 10,5×12,5 mm	403
122 91 0285	Hlava sací se zvětšováním	Suction head with magnification	403
122 91 0286	Bruenings balónek s trubičkou pro otoskop	Bruenings rubber bulb only for otoscope	403
122 91 0288	Siegle otoskop komplet	Siegle otoscope set	403
122 91 0289	Siegle zrcátko ušní fig.1; 5,0/6,0 mm	Siegle ear speculum fig.1; 5,0/6,0 mm	403
122 91 0290	Siegle zrcátko ušní fig.2; 6,0/7,0 mm	Siegle ear speculum fig.2; 6,0/7,0 mm	403
122 91 0291	Siegle zrcátko ušní fig.3; 7,0/8,0 mm	Siegle ear speculum fig.3; 7,0/8,0 mm	403
122 91 0292	Trubička gumová s balónkem pro Siegle	Rubber tube and bulb only for Siegle speculum	403
122 91 0296	Hartmann-Halle zrcátko nosní fig.1; 15,0 cm	Hartmann-Halle nasal speculum fig.1; 15,0 cm	405
122 91 0298	Hartmann-Halle zrcátko nosní fig.2; 15,0 cm	Hartmann-Halle nasal speculum fig.2; 15,0 cm	405
122 91 0300	Hartmann-Halle zrcátko nosní fig.3; 15,0 cm	Hartmann-Halle nasal speculum fig.3; 15,0 cm	405
122 91 0302	Hartmann zrcátko nosní fig.1; 15,0 cm	Hartmann nasal speculum fig.1; 15,0 cm	405; 432; 433; 435
122 91 0304	Hartmann zrcátko nosní fig.2; 15,0 cm	Hartmann nasal speculum fig.2; 15,0 cm	405; 432; 433; 435
122 91 0306	Hartmann zrcátko nosní fig.3; 15,0 cm	Hartmann nasal speculum fig.3; 15,0 cm	405; 432; 433; 435
122 91 0308	Tieck-Halle zrcátko nosní fig.1; 13,5 cm	Tieck-Halle nasal speculum fig.1; 13,5 cm	405
122 91 0310	Tieck-Halle zrcátko nosní fig.2; 13,5 cm	Tieck-Halle nasal speculum fig.2; 13,5 cm	405
122 91 0328	Mod. Wien zrcátko nosní fig.1; 14,5 cm	Mod. Wien nasal speculum fig.1; 14,5 cm	405
122 91 0330	Mod. Wien zrcátko nosní fig.2; 14,5 cm	Mod. Wien nasal speculum fig.2; 14,5 cm	405
122 91 0332	Mod. Wien zrcátko nosní fig.3; 14,5 cm	Mod. Wien nasal speculum fig.3; 14,5 cm	405
122 91 0365	Sims zrcadlo rektální; 15,0 cm	Sims rectal speculum; 15,0 cm	257
122 91 0366	Sims zrcadlo rektální; 15,0 cm	Sims rectal speculum; 15,0 cm	257
122 91 0371	Pratt zrcadlo rektální; 21,0 cm	Pratt rectal speculum; 21,0 cm	257
122 91 0382	Ives-Fansler anoskop s gumovým obturátorem; 22 mm	Ives-Fansler anoscope with rubber obturator; 22 mm	258
122 91 0385	Hirschmann anoskop s obturátorem; 16×65 mm	Hirschmann anoscope with obturator; 16×65 mm	258
122 91 0386	Hirschmann anoskop s obturátorem; 19×65 mm	Hirschmann anoscope with obturator; 19×65 mm	258
122 91 0387	Hirschmann anoskop s obturátorem; 22×65 mm	Hirschmann anoscope with obturator; 22×65 mm	258
122 91 0388	Hirschmann anoskop s obturátorem; 22×125mm	Hirschmann anoscope with obturator; 22×125mm	258
122 91 0394	Bensaude anoskop s obturátorem; 19×70 mm	Bensaude anoscope with obturator; 19×70 mm	258
122 91 0395	Bensaude anoskop s obturátorem; 22×70 mm	Bensaude anoscope with obturator; 22×70 mm	258
122 91 0396	Kelly proktoskop s obturátorem; 22×50 mm	Kelly proctoscope with obturator; 22×50 mm	258
122 91 0397	Kelly proktoskop s obturátorem; 22×100 mm	Kelly proctoscope with obturator; 22×100 mm	258
122 91 0398	Kelly proktoskop s obturátorem; 22×140 mm	Kelly proctoscope with obturator; 22×140 mm	258
122 91 0399	Kelly proktoskop s obturátorem; 22×200 mm	Kelly proctoscope with obturator; 22×200 mm	258
122 91 0400	Kelly sphinkteroskop s obturátorem; 21×50 mm	Kelly sphincteroscope with obturator; 21×50 mm	258
122 91 0401	Kelly sphinkteroskop s obturátorem; 27×50 mm	Kelly sphincteroscope with obturator; 27×50 mm	258
123 08 0010	Langenbeck páčidlo fig. 1; 20,0 cm	Langenbeck elevator fig. 1; 20,0 cm	261
123 08 0020	Langenbeck páčidlo fig. 2; 20,0 cm	Langenbeck elevator fig. 2; 20,0 cm	261
123 08 0030	Williger páčidlo fig.1; 16,0 cm	Williger elevator fig.1; 16,0 cm	261

číslo – number	název	item	strana – page
123 09 0300	Hohmann páčidlo přímé tupé fig.1; 14,0 cm	Hohmann elevator fig.1; 14.0 cm	261
123 09 0310	Hohmann páčidlo přímé tupé fig.2; 19,6 cm	Hohmann elevator fig.2; 19.6 cm	261
123 09 0320	Hohmann páčidlo přímé ostré fig.1; 14,0 cm	Hohmann elevator fig.1; 14.0 cm	261
123 09 0330	Hohmann páčidlo přímé ostré fig.2; 19,6 cm	Hohmann elevator fig.2; 19.6 cm	261
123 09 0400	Páčidlo prohnuté široké; 22,7 cm	Elevator; 22.7 cm	262
123 29 0010	Páčka ušní zahnutá; 16,0 cm	Ear elevator; 16.0 cm	407
123 29 0020	Lucae páčka ušní; 2,0 mm; 14,0 cm	Lucae ear elevator; 2.0 mm; 14.0 cm	407
123 29 0030	Lucae páčka ušní; 3,0 mm; 14,0 cm	Lucae ear elevator; 3.0 mm; 14.0 cm	407
123 29 0040	Lucae páčka ušní; 4,0 mm; 14,0 cm	Lucae ear elevator; 4.0 mm; 14.0 cm	407
123 29 0080	Lucae páčka ušní lžičkovitá; 2,2 mm; 16,0 cm	Lucae ear elevator; 2.2 mm; 16.0 cm	407
123 30 0030	Freer páčidlo na nosní přepážku dvojitě; 19,5 cm	Freer septum elevator; 19.5 cm	408; 434
123 91 0001	McKenty páčidlo nosní 4,0 mm; 14,5 cm	McKenty nasal elevator; 14.5 cm	409
123 91 0002	McKenty páčidlo nosní 5,0 mm; 14,5 cm	McKenty nasal elevator; 14.5 cm	409
123 91 0004	Halle páčidlo nosní; 16,5 cm	Halle nasal elevator; 16.5 cm	409
123 91 0005	Joseph páčidlo nosní; 16,0 cm	Joseph nasal elevator; 16.0 cm	409
123 91 0006	Freer páčidlo nosní ostré; 19,0 cm	Freer nasal elevator; 19.0 cm	408; 433; 435
123 91 0007	Freer páčidlo nosní tupé; 19,0 cm	Freer nasal elevator; 19.0 cm	408
123 91 0008	Freer páčidlo nosní ostro-tupé; 18,0cm	Freer nasal elevator; 18.0 cm	408
123 91 0009	Cottle páčidlo nosní; 23,0 cm	Cottle nasal elevator; 23.0 cm	408; 433
123 91 0010	McKenty páčidlo nosní; 22,0 cm	McKenty nasal elevator; 22.0 cm	409
123 91 0011	Cottle páčidlo nosní; 21,0 cm	Cottle nasal elevator; 21.0 cm	409
123 91 0012	Masing páčidlo nosní; 21,0 cm	Masing nasal elevator; 21.0 cm	409
123 91 0013	Howarth páčidlo nosní; 21,5 cm	Howarth nasal elevator; 21.5 cm	409
123 91 0014	Killian páčidlo nosní; 18,0 cm	Killian nasal elevator; 18.0 cm	409
123 91 0015	Killian páčidlo nosní; 22,0 cm	Killian nasal elevator; 22.0 cm	409
123 91 0018	Henke páčidlo na mandle; 23,0 cm	Henke dissector; 23.0 cm	410; 434
123 91 0019	Henke páčidlo na mandle; 23,0 cm	Henke dissector; 23.0 cm	410
123 91 0020	Lopez-Reinke páčidlo na mandle; 23,0 cm	Lopez-Reinke dissector; 23.0 cm	410
123 91 0022	Lempert páčka ušní; 2,0 mm; 17,0 cm	Lempert ear elevator; 2.0 mm; 17.0 cm	408
123 91 0023	Lempert páčka ušní; 3,0 mm; 17,0 cm	Lempert ear elevator; 3.0 mm; 17.0 cm	408
123 91 0024	Lempert páčka ušní; 4,0 mm; 17,0 cm	Lempert ear elevator; 4.0 mm; 17.0 cm	408
123 91 0025	Lempert páčka ušní; 5,0 mm; 17,0 cm	Lempert ear elevator; 5.0 mm; 17.0 cm	408
123 91 0026	Hohmann páka kostní; 24 mm; 28,0 cm	Hohmann bone elevator; 24 mm; 28.0 cm	265
123 91 0027	Mini-Hohmann páka kostní; 6 mm; 16,0 cm	Mini-Hohmann bone elevator; 6 mm; 16.0 cm	263
123 91 0028	Mini-Hohmann páka kostní; 8 mm; 16,0 cm	Mini-Hohmann bone elevator; 8 mm; 16.0 cm	263
123 91 0029	Hohmann páka kostní; 35 mm; 29,0 cm	Hohmann bone elevator; 35 mm; 29.0 cm	265
123 91 0030	Páka kostní; 6 mm; 14,0 cm	Bone elevator; 6 mm; 14.0 cm	263
123 91 0031	Páka kostní; 15 mm; 17,0 cm	Bone elevator; 15 mm; 17.0 cm	263
123 91 0032	Páka kostní; 16 mm; 12,0 cm	Bone elevator; 16 mm; 12.0 cm	263
123 91 0033	Hohmann páka kostní; 8 mm; 22,0 cm	Hohmann bone elevator; 8 mm; 22.0 cm	264
123 91 0034	Hohmann páka kostní; 18 mm; 24,0 cm	Hohmann bone elevator; 18 mm; 24.0 cm	264
123 91 0035	Hohmann páka kostní; 43 mm; 24,0 cm	Hohmann bone elevator; 43 mm; 24.0 cm	264
123 91 0036	Hohmann páka kostní; 70 mm; 25,0 cm	Hohmann bone elevator; 70 mm; 25.0 cm	264
123 91 0037	Hohmann páka kostní; 22 mm; 25,0 cm	Hohmann bone elevator; 22 mm; 25.0 cm	265
123 91 0038	Hohmann páka kostní; 43 mm; 25,0 cm	Hohmann bone elevator; 43 mm; 25.0 cm	265
123 91 0039	Lange-Hohmann páka kostní; 22 mm; 26,0 cm	Lange-Hohmann bone elevator; 22 mm; 26.0 cm	265
123 91 0040	Blount páka kostní; 26,0 cm	Blount bone elevator; 26.0 cm	266
123 91 0041	Blount páka kostní; 26,0 cm	Blount bone elevator; 26.0 cm	266
123 91 0042	Taylor páka kostní; 75×30 mm; 16,5 cm	Taylor bone elevator; 75×30 mm; 16.5 cm	266
123 91 0043	Taylor páka kostní; 100×30 mm; 16,5 cm	Taylor bone elevator; 100×30 mm; 16.5 cm	266
123 91 0079	Nástroj mikro; 23,0 cm	Micro instrument; 23.0 cm	552
123 91 0080	Nástroj mikro; 23,0 cm	Micro instrument; 23.0 cm	552
123 91 0081	Nástroj mikro; 23,0 cm	Micro instrument; 23.0 cm	552
123 91 0082	Nástroj mikro; 23,0 cm	Micro instrument; 23.0 cm	552
123 91 0083	Nástroj mikro; 23,0 cm	Micro instrument; 23.0 cm	552
123 91 0084	Nástroj mikro; 23,0 cm	Micro instrument; 23.0 cm	552
123 91 0085	Nástroj mikro; 23,0 cm	Micro instrument; 23.0 cm	552
123 91 0086	Caspar nástroj mikro; 23,0 cm	Caspar micro instrument; 23.0 cm	553
123 91 0087	Caspar nástroj mikro; 23,0 cm	Caspar micro instrument; 23.0 cm	553
123 91 0088	Caspar nástroj mikro; 23,0 cm	Caspar micro instrument; 23.0 cm	553
123 91 0089	Caspar nástroj mikro; 20,0 cm	Caspar micro instrument; 20.0 cm	553
123 91 0090	Caspar nástroj mikro; 21,0 cm	Caspar micro instrument; 21.0 cm	553
123 91 0091	Caspar nástroj mikro; 21,0 cm	Caspar micro instrument; 21.0 cm	553
123 91 0092	Nástroj mikro; 18,5 cm	Micro instrument; 18.5 cm	553
123 91 0093	Nástroj mikro; 21,5 cm	Micro instrument; 21.5 cm	553
123 91 0094	Caspar nástroj mikro; 24,5 cm	Caspar micro instrument; 24.5 cm	554
123 91 0095	Caspar nástroj mikro; 24,5 cm	Caspar micro instrument; 24.5 cm	554
123 91 0096	Caspar nástroj mikro; 24,5 cm	Caspar micro instrument; 24.5 cm	554
123 91 0097	Caspar nástroj mikro; 24,5 cm	Caspar micro instrument; 24.5 cm	554
123 91 0098	Samii nástroj mikro; 20,0 cm	Samii micro instrument; 20.0 cm	554
123 91 0099	Samii nástroj mikro; 20,0 cm	Samii micro instrument; 20.0 cm	554
123 91 0100	Samii nástroj mikro; 20,0 cm	Samii micro instrument; 20.0 cm	554
123 91 0101	Samii nástroj mikro; 20,0 cm	Samii micro instrument; 20.0 cm	554
123 91 0102	Samii nástroj mikro; 20,0 cm	Samii micro instrument; 20.0 cm	554
123 91 0103	Samii nástroj mikro; 20,0 cm	Samii micro instrument; 20.0 cm	554
123 91 0104	Samii nástroj mikro; 20,0 cm	Samii micro instrument; 20.0 cm	554
123 91 0105	Samii nástroj mikro; 20,0 cm	Samii micro instrument; 20.0 cm	554
123 91 0106	Samii nástroj mikro; 23,0 cm	Samii micro instrument; 23.0 cm	554
123 91 0107	Samii nástroj mikro; 23,0 cm	Samii micro instrument; 23.0 cm	554
123 91 0108	Samii nástroj mikro; 23,0 cm	Samii micro instrument; 23.0 cm	554
123 91 0109	Samii nástroj mikro; 23,0 cm	Samii micro instrument; 23.0 cm	554
123 91 0110	Samii nástroj mikro; 23,0 cm	Samii micro instrument; 23.0 cm	554
123 91 0111	Samii nástroj mikro; 23,0 cm	Samii micro instrument; 23.0 cm	554
123 91 0112	Samii nástroj mikro; 23,0 cm	Samii micro instrument; 23.0 cm	554

číslo – number	název	item	strana – page
123 91 0113	Samii nástroj mikro; 23,0 cm	Samii micro instrument; 23,0 cm	554
123 99 0033	Páčidlo úzké ostré; 24,0 cm	Elevator; 24,0 cm	261
123 99 0084	Páčidlo na nosní přepážku	Septum nasal elevator	408
123 99 0097	Páčidlo tupé široké; 11 mm	Elevator blunt wide; 11 mm	262
124 08 0111	Williger škrabka fig.2; 16,0 cm	Williger raspatory fig.2; 16,0 cm	269
124 08 0120	Langenbeck škrabka rovná; 19,0 cm	Langenbeck raspatory; 19,0 cm	269
124 08 0130	Langenbeck škrabka zahnutá; 20,4 cm	Langenbeck raspatory; 20,4 cm	269
124 08 0170	Farabeuf škrabka rovná; 15,0 cm	Farabeuf raspatory; 15,0 cm	269
124 08 0250	Williger škrabka; 5,0 mm; 16,0 cm	Williger raspatory; 5,0 mm; 16,0 cm	269
124 08 0280	Williger škrabka rovná; 3,5 mm; 16,0 cm	Williger raspatory; 3,5 mm; 16,0 cm	269
124 08 0290	Williger škrabka zahnutá; 4,0 mm; 16,0 cm	Williger raspatory; 4,0 mm; 16,0 cm	269
124 10 0101	Doyen škrabka na žebra dětská levá; 17,0 cm	Doyen rib raspatory; 17,0 cm	270
124 10 0111	Doyen škrabka na žebra dětská pravá; 17,0 cm	Doyen rib raspatory; 17,0 cm	270
124 14 0040	Sauerbruch škrabka zahnutá; 19,0 cm	Sauerbruch raspatory; 19,0 cm	271
124 14 0050	Ollier škrabka okrouhlá rovná; 12,0 mm; 22,6 cm	Ollier raspatory; 12,0 mm; 22,6 cm	270
124 14 0051	Ollier škrabka okrouhlá rovná; 12,0 mm; 23,1 cm	Ollier raspatory; 12,0 mm; 23,1 cm	270
124 14 0060	Ollier škrabka okrouhlá rovná; 16,0 mm; 22,6 cm	Ollier raspatory; 16,0 mm; 22,6 cm	270
124 14 0061	Ollier škrabka okrouhlá rovná; 16,0 mm; 23,1 cm	Ollier raspatory; 16,0 mm; 23,1 cm	270
124 14 0070	Ollier škrabka okrouhlá rovná; 18,0 mm; 22,6 cm	Ollier raspatory; 18,0 mm; 22,6 cm	270
124 14 0071	Ollier škrabka okrouhlá rovná; 18,0 mm; 23,1 cm	Ollier raspatory; 18,0 mm; 23,1 cm	270
124 14 0110	Ollier škrabka exartikulační žláb. rovná; 19,3 cm	Ollier raspatory; 19,3 cm	271
124 14 0111	Ollier škrabka exartikulační žláb. zahnutá; 19,8 cm	Ollier raspatory; 19,8 cm	271
124 14 0130	Škrabka exartikulační prohnutá; 6,0 mm; 20,0 cm	Raspatory; 6,0 mm; 20,0 cm	271
124 14 0181	Doyen škrabka na žebra pravá; 17,0 cm	Doyen rib raspatory; 17,0 cm	270
124 14 0191	Doyen škrabka na žebra levá; 17,0 cm	Doyen rib raspatory; 17,0 cm	270
124 30 0020	Přecechtěl škrabka nosní; 19,0 cm	Přecechtěl nasal raspatory; 19,0 cm	411; 434
124 32 0010	Hurd škrabka na mandle; 12x8 mm; 21,0 cm	Hurd tonsil raspatory; 12x8 mm; 21,0 cm	411; 434; 435
124 38 0070	Škrabka na rohovku lomená; 12,5 cm	Corneal scarifier; 12,5 cm	272
124 38 0160	Škrabka na operaci slzného vaku; 17,2 cm	Lachrymal sac raspatory; 17,2 cm	272
124 91 0001	Hurd škrabka nosní; 6 mm; 22,5 cm	Hurd nasal raspatory; 6 mm; 22,5 cm	411
124 91 0002	Hurd škrabka nosní; 10 mm; 22,5 cm	Hurd nasal raspatory; 10 mm; 22,5 cm	411
124 91 0014	Lempert škrabka; 3,0 mm; 16,0 cm	Lempert raspatory; 3,0 mm; 16,0 cm	411
125 08 0110	Lžička ostrá oválná fig. 000; 3,5 mm; 17,0 cm	Spoon sharp fig. 000; 3,5 mm; 17,0 cm	275
125 08 0120	Lžička ostrá oválná fig. 0; 4,8 mm; 17,2 cm	Spoon sharp fig. 0; 4,8 mm; 17,2 cm	275
125 08 0130	Lžička ostrá oválná fig. 1; 6,0 mm; 17,5 cm	Spoon sharp fig. 1; 6,0 mm; 17,5 cm	275
125 08 0140	Lžička ostrá oválná fig. 3; 8,5 mm; 17,7 cm	Spoon sharp fig. 3; 8,5 mm; 17,7 cm	275
125 08 0150	Lžička ostrá oválná fig. 5; 12,0 mm; 18,4 cm	Spoon sharp fig. 5; 12,0 mm; 18,4 cm	275
125 08 0160	Lžička ostrá trepanační fig. 1; 3,0 mm; 16,5 cm	Spoon sharp fig. 1; 3,0 mm; 16,5 cm	275
125 08 0170	Lžička ostrá trepanační fig. 2; 3,5 mm; 16,5 cm	Spoon sharp fig. 2; 3,5 mm; 16,5 cm	275
125 08 0180	Lžička ostrá trepanační fig. 3; 4,0 mm; 17,5 cm	Spoon sharp fig. 3; 4,0 mm; 17,5 cm	275
125 08 0190	Lžička ostrá trepanační fig. 4; 5,0 mm; 17,5 cm	Spoon sharp fig. 4; 5,0 mm; 17,5 cm	275
125 08 0200	Lžička ostrá trepanační fig. 5; 6,0 mm; 19,5 cm	Spoon sharp fig. 5; 6,0 mm; 19,5 cm	275
125 08 0210	Lžička ostrá trepanační fig. 6; 6,7 mm; 19,5 cm	Spoon sharp fig. 6; 6,7 mm; 19,5 cm	275
125 08 0310	Volkmann lžička ostrá; 8,5; 5,5 mm; 13,0 cm	Volkmann spoon; 8,5; 5,5 mm; 13,0 cm	278
125 09 0010	Lžička ortopedická; 14,5x24 mm; 35,0 cm	Spoon orthopaedic; 14,5x24 mm; 35,0 cm	280
125 17 0120	Lžička na páteř; 2x4 mm; 21,5 cm	Spinal spoon; 2x4 mm; 21,5 mm	280
125 17 0130	Lžička na páteř; 3x4 mm; 21,5 cm	Spinal spoon; 3x4 mm; 21,5 mm	280
125 17 0140	Lžička na páteř; 4x8 mm; 21,5 cm	Spinal spoon; 4x8 mm; 21,5 mm	280
125 17 0150	Lžička na páteř; 5x9 mm; 21,5 cm	Spinal spoon; 5x9 mm; 21,5 mm	280
125 17 0160	Lžička na páteř; 9x12 mm; 21,5 cm	Spinal spoon; 9x12 mm; 21,5 mm	280
125 17 0170	Lžička na páteř; 12x16 mm; 21,5 cm	Spinal spoon; 12x16 mm; 21,5 mm	280
125 17 0300	Cloward lžička přímá 45°; 4,2 mm; 23,0 cm	Cloward spoon straight 45°; 4,2 mm; 23,0 cm	280
125 27 0050	Lžička děložní oválná; 7x10 mm; 30,0 cm	Uterine spoon; 7x10 mm; 30,0 cm	480
125 27 0060	Lžička děložní oválná; 12x18 mm; 30,0 cm	Uterine spoon; 12x18 mm; 30,0 cm	480
125 27 0070	Recamier lžička děložní fig. 1; 6,8 mm; 31,0 cm	Recamier uterine spoon fig.1; 6,8 mm; 31,0 cm	480
125 27 0080	Recamier lžička děložní fig. 2; 8,5 mm; 31,0 cm	Recamier uterine spoon fig.2; 8,5 mm; 31,0 cm	480
125 27 0090	Recamier lžička děložní fig. 3; 10,0 mm; 31,0 cm	Recamier uterine spoon fig.3; 10,0 mm; 31,0 cm	480
125 27 0100	Recamier lžička děložní fig. 4; 11,5 mm; 31,0 cm	Recamier uterine spoon fig.4; 11,5 mm; 31,0 cm	480
125 38 0010	Meyhöfer lžička na chalazia kulatá; 1,6 mm	Meyhöfer chalazion spoon; 1,6 mm	279
125 38 0020	Meyhöfer lžička na chalazia kulatá; 2,2 mm	Meyhöfer chalazion spoon; 2,2 mm	279
125 38 0030	Meyhöfer lžička na chalazia kulatá; 2,5 mm	Meyhöfer chalazion spoon; 2,5 mm	279
125 38 0040	Meyhöfer lžička na chalazia kulatá; 3,4 mm	Meyhöfer chalazion spoon; 3,4 mm	279
125 38 0050	Meyhöfer lžička na chalazia kulatá; 4,0 mm	Meyhöfer chalazion spoon; 4,0 mm	279
125 38 0360	Daviel lžička oční s lopatkou fig.1; 1x1,6 mm	Daviel eye spoon with spatula fig.1; 1x1,6 mm	279
125 38 0370	Daviel lžička oční s lopatkou fig.2; 1x2,2 mm	Daviel eye spoon with spatula fig.2; 1x2,2 mm	279
125 38 0530	Lang lžička oční ostrá; 3,5x4,5 mm; 15,0 cm	Lang eye spoon; 3,5x4,5 mm; 15,0 cm	279
125 91 0001	Simon/Schröder lžice děložní fig. 1; 25,0 cm	Simon/Schröder uterine scoop fig. 1; 25,0 cm	481
125 91 0002	Simon/Schröder lžice děložní fig. 2; 25,0 cm	Simon/Schröder uterine scoop fig. 2; 25,0 cm	481
125 91 0003	Simon/Schröder lžice děložní fig. 3; 25,0 cm	Simon/Schröder uterine scoop fig. 3; 25,0 cm	481
125 91 0004	Simon/Schröder lžice děložní fig. 4; 25,0 cm	Simon/Schröder uterine scoop fig. 4; 25,0 cm	481
125 91 0005	Simon/Schröder lžice děložní fig. 5; 25,0 cm	Simon/Schröder uterine scoop fig. 5; 25,0 cm	481
125 91 0006	Simon/Schröder lžice děložní fig. 6; 25,0 cm	Simon/Schröder uterine scoop fig. 6; 25,0 cm	481
125 91 0007	Simon/Schröder lžice děložní fig. 1; 30,0 cm	Simon/Schröder uterine scoop fig. 1; 30,0 cm	481
125 91 0008	Simon/Schröder lžice děložní fig. 2; 30,0 cm	Simon/Schröder uterine scoop fig. 2; 30,0 cm	481
125 91 0009	Simon/Schröder lžice děložní fig. 3; 30,0 cm	Simon/Schröder uterine scoop fig. 3; 30,0 cm	481
125 91 0010	Simon/Schröder lžice děložní fig. 4; 30,0 cm	Simon/Schröder uterine scoop fig. 4; 30,0 cm	481
125 91 0011	Simon/Schröder lžice děložní fig. 5; 30,0 cm	Simon/Schröder uterine scoop fig. 5; 30,0 cm	481
125 91 0012	Simon/Schröder lžice děložní fig. 6; 30,0 cm	Simon/Schröder uterine scoop fig. 6; 30,0 cm	481
125 91 0013	Gourdet lžice děložní fig. 1; 28,0 cm	Gourdet uterine scoop fig. 1; 28,0 cm	481
125 91 0014	Gourdet lžice děložní fig. 2; 28,0 cm	Gourdet uterine scoop fig. 2; 28,0 cm	481
125 91 0015	Gourdet lžice děložní fig. 3; 28,0 cm	Gourdet uterine scoop fig. 3; 28,0 cm	481
125 91 0016	Gourdet lžice děložní fig. 4; 28,0 cm	Gourdet uterine scoop fig. 4; 28,0 cm	481
125 91 0017	Gourdet lžice děložní fig. 5; 28,0 cm	Gourdet uterine scoop fig. 5; 28,0 cm	481
125 91 0018	Wallich lžice děložní; 42,0 cm	Wallich uterine scoop; 42,0 cm	481



číslo – number	název	item	strana – page
125 91 0148	Luer-Koerte lžička na žlučové kameny; 2,5 mm; 32 cm	Luer-Koerte gall stone scoop; 2,5 mm; 32 cm	278
125 91 0149	Luer-Koerte lžička na žlučové kameny; 3,2 mm; 32 cm	Luer-Koerte gall stone scoop; 3,2 mm; 32 cm	278
125 91 0150	Luer-Koerte lžička na žlučové kameny; 4,2 mm; 32 cm	Luer-Koerte gall stone scoop; 4,2 mm; 32 cm	278
125 91 0151	Luer-Koerte lžička na žlučové kameny; 5,5 mm; 32 cm	Luer-Koerte gall stone scoop; 5,5 mm; 32 cm	278
125 91 0152	Luer-Koerte lžička na žlučové kameny; 6,7 mm; 32 cm	Luer-Koerte gall stone scoop; 6,7 mm; 32 cm	278
125 91 0153	Luer-Koerte lžička na žlučové kameny; 8 mm; 32 cm	Luer-Koerte gall stone scoop; 8 mm; 32 cm	278
125 91 0154	Luer-Koerte lžička na žlučové kameny; 11 mm; 32 cm	Luer-Koerte gall stone scoop; 11 mm; 32 cm	278
125 91 0155	Luer-Koerte lžička na žlučové kameny; 15 mm; 32 cm	Luer-Koerte gall stone scoop; 15 mm; 32 cm	278
126 27 0010	Kyreta děložní ostrá fig. 1; žlábkové držadlo	Uterine curette sharp fig.1; concave handle	482
126 27 0011	Kyreta děložní ostrá fig. 1; osmihřanné držadlo	Uterine curette sharp fig.1; hexagonal handle	482
126 27 0020	Kyreta děložní ostrá fig. 2; žlábkové držadlo	Uterine curette sharp fig.2; concave handle	482
126 27 0021	Kyreta děložní ostrá fig. 2; osmihřanné držadlo	Uterine curette sharp fig.2; hexagonal handle	482
126 27 0030	Kyreta děložní ostrá fig. 3; žlábkové držadlo	Uterine curette sharp fig.3; concave handle	482
126 27 0031	Kyreta děložní ostrá fig. 3; osmihřanné držadlo	Uterine curette sharp fig.3; hexagonal handle	482
126 27 0040	Kyreta děložní ostrá fig. 4; žlábkové držadlo	Uterine curette sharp fig.4; concave handle	482
126 27 0041	Kyreta děložní ostrá fig. 4; osmihřanné držadlo	Uterine curette sharp fig.4; hexagonal handle	482
126 27 0050	Kyreta děložní ostrá fig. 5; žlábkové držadlo	Uterine curette sharp fig.5; concave handle	482
126 27 0051	Kyreta děložní ostrá fig. 5; osmihřanné držadlo	Uterine curette sharp fig.5; hexagonal handle	482
126 27 0060	Kyreta děložní ostrá fig. 6; žlábkové držadlo	Uterine curette sharp fig.6; concave handle	482
126 27 0061	Kyreta děložní ostrá fig. 6; osmihřanné držadlo	Uterine curette sharp fig.6; hexagonal handle	482
126 27 0070	Kyreta děložní ostrá fig. 7; žlábkové držadlo	Uterine curette sharp fig.7; concave handle	482
126 27 0071	Kyreta děložní ostrá fig. 7; osmihřanné držadlo	Uterine curette sharp fig.7; hexagonal handle	482
126 27 0080	Kyreta děložní ostrá fig. 8; žlábkové držadlo	Uterine curette sharp fig.8; concave handle	482
126 27 0081	Kyreta děložní ostrá fig. 8; osmihřanné držadlo	Uterine curette sharp fig.8; hexagonal handle	482
126 27 0110	Kyreta děložní tupá fig. 1; žlábkové držadlo	Uterine curette blunt fig.1; concave handle	483
126 27 0111	Kyreta děložní tupá fig. 1; osmihřanné držadlo	Uterine curette blunt fig.1; hexagonal handle	483
126 27 0120	Kyreta děložní tupá fig. 2; žlábkové držadlo	Uterine curette blunt fig.2; concave handle	483
126 27 0121	Kyreta děložní tupá fig. 2; osmihřanné držadlo	Uterine curette blunt fig.2; hexagonal handle	483
126 27 0130	Kyreta děložní tupá fig. 3; žlábkové držadlo	Uterine curette blunt fig.3; concave handle	483
126 27 0131	Kyreta děložní tupá fig. 3; osmihřanné držadlo	Uterine curette blunt fig.3; hexagonal handle	483
126 27 0140	Kyreta děložní tupá fig. 4; žlábkové držadlo	Uterine curette blunt fig.4; concave handle	483
126 27 0141	Kyreta děložní tupá fig. 4; osmihřanné držadlo	Uterine curette blunt fig.4; hexagonal handle	483
126 27 0150	Kyreta děložní tupá fig. 5; žlábkové držadlo	Uterine curette blunt fig.5; concave handle	483
126 27 0151	Kyreta děložní tupá fig. 5; osmihřanné držadlo	Uterine curette blunt fig.5; hexagonal handle	483
126 27 0160	Kyreta děložní tupá fig. 6; žlábkové držadlo	Uterine curette blunt fig.6; concave handle	483
126 27 0161	Kyreta děložní tupá fig. 6; osmihřanné držadlo	Uterine curette blunt fig.6; hexagonal handle	483
126 27 0170	Kyreta děložní tupá fig. 7; žlábkové držadlo	Uterine curette blunt fig.7; concave handle	483
126 27 0171	Kyreta děložní tupá fig. 7; osmihřanné držadlo	Uterine curette blunt fig.7; hexagonal handle	483
126 27 0180	Kyreta děložní tupá fig. 8; žlábkové držadlo	Uterine curette blunt fig.8; concave handle	483
126 27 0181	Kyreta děložní tupá fig. 8; osmihřanné držadlo	Uterine curette blunt fig.8; hexagonal handle	483
126 27 0641	Bumm kyreta děložní tupá ohebná fig. 13; 34,0 cm	Bumm uterine curette blunt maleable fig. 13; 34,0 cm	487
126 27 0691	Bumm kyreta děložní tupá ohebná fig. 15; 34,0 cm	Bumm uterine curette blunt maleable fig. 15; 34,0 cm	487
126 32 0080	Smyčka drátěná; 0,3 mm; 5,0 cm	Wire loop for tonsil; 0,3 mm; 5,0 cm	417
126 32 0090	Smyčka drátěná; 0,4 mm; 5,0 cm	Wire loop for tonsil; 0,4 mm; 5,0 cm	417
126 32 0110	Smyčka drátěná; 0,5 mm; 5,0 cm	Wire loop for tonsil; 0,5 mm; 5,0 cm	417
126 32 0120	Smyčka drátěná; 0,3 mm; 4,0 cm	Wire loop for tonsil; 0,3 mm; 4,0 cm	417; 434
126 32 0130	Smyčka drátěná; 0,4 mm; 4,0 cm	Wire loop for tonsil; 0,4 mm; 4,0 cm	417; 434
126 32 0140	Smyčka drátěná; 0,5 mm; 4,0 cm	Wire loop for tonsil; 0,5 mm; 4,0 cm	417; 434
126 32 0160	Smyčka drátěná; 0,4 mm; 4,5 cm	Wire loop for tonsil; 0,4 mm; 4,5 cm	417
126 91 0001	Bruenings skřípec na mandle; 28,0 cm	Bruenings tonsil snare; 28,0 cm	417; 434
126 91 0010	Buck kyreta ušní ostrá zahnutá fig.000; 16,5 cm	Buck ear curette sharp curved fig.000; 16,5 cm	413
126 91 0011	Buck kyreta ušní ostrá zahnutá fig.00; 16,5 cm	Buck ear curette sharp curved fig.00; 16,5 cm	413
126 91 0012	Buck kyreta ušní ostrá zahnutá fig.0; 16,5 cm	Buck ear curette sharp curved fig.0; 16,5 cm	413
126 91 0013	Buck kyreta ušní ostrá zahnutá fig.1; 16,5 cm	Buck ear curette sharp curved fig.1; 16,5 cm	413
126 91 0014	Buck kyreta ušní ostrá zahnutá fig.2; 16,5 cm	Buck ear curette sharp curved fig.2; 16,5 cm	413
126 91 0015	Buck kyreta ušní ostrá zahnutá fig.3; 16,5 cm	Buck ear curette sharp curved fig.3; 16,5 cm	413
126 91 0016	Buck kyreta ušní ostrá zahnutá fig.4; 16,5 cm	Buck ear curette sharp curved fig.4; 16,5 cm	413
126 91 0017	Buck kyreta ušní ostrá zahnutá fig.5; 16,5 cm	Buck ear curette sharp curved fig.5; 16,5 cm	413
126 91 0018	Shapleigh kyreta ušní fig.1; 13,0 cm	Shapleigh ear curette fig.1; 13,0 cm	413
126 91 0019	Shapleigh kyreta ušní fig.2; 13,0 cm	Shapleigh ear curette fig.2; 13,0 cm	413
126 91 0020	Langenbeck kyreta ušní; 13,0 cm	Langenbeck ear curette; 13,0 cm	413
126 91 0021	Milan kyreta na biopsii; 4 mm; 28,0 cm	Milan biopsy curette; 28,0 cm	488
126 91 0022	Milan kyreta na biopsii; 6 mm; 28,0 cm	Milan biopsy curette; 28,0 cm	488
126 91 0023	Milan kyreta na biopsii; 9 mm; 28,0 cm	Milan biopsy curette; 28,0 cm	488
126 91 0032	Recamier/Sims kyreta ostrá ohebná; 5 mm; 31 cm	Recamier/Sims uterine curette sharp fig. 00; 5 mm; 31,0 cm	484
126 91 0033	Recamier/Sims kyreta ostrá ohebná; 6 mm; 31 cm	Recamier/Sims uterine curette sharp fig. 0; 6 mm; 31,0 cm	484
126 91 0034	Recamier/Sims kyreta ostrá ohebná; 7 mm; 31 cm	Recamier/Sims uterine curette sharp fig. 1; 7 mm; 31,0 cm	484
126 91 0035	Recamier/Sims kyreta ostrá ohebná; 8 mm; 31 cm	Recamier/Sims uterine curette sharp fig. 2; 8 mm; 31,0 cm	484
126 91 0036	Recamier/Sims kyreta ostrá ohebná; 9 mm; 31 cm	Recamier/Sims uterine curette sharp fig. 3; 9 mm; 31,0 cm	484
126 91 0037	Recamier/Sims kyreta ostrá ohebná; 11 mm; 31 cm	Recamier/Sims uterine curette sharp fig. 4; 11 mm; 31,0 cm	484
126 91 0038	Recamier/Sims kyreta ostrá ohebná; 12 mm; 31 cm	Recamier/Sims uterine curette sharp fig. 5; 12 mm; 31,0 cm	484
126 91 0039	Recamier/Sims kyreta ostrá ohebná; 14 mm; 31 cm	Recamier/Sims uterine curette sharp fig. 6; 14 mm; 31,0 cm	484
126 91 0040	Recamier/Sims kyreta ostrá ohebná; 15 mm; 31 cm	Recamier/Sims uterine curette sharp fig. 7; 15 mm; 31,0 cm	484
126 91 0041	Recamier/Sims kyreta ostrá ohebná; 16 mm; 31 cm	Recamier/Sims uterine curette sharp fig. 8; 16 mm; 31,0 cm	484
126 91 0042	Recamier/Sims kyreta ostrá ohebná; 19 mm; 31 cm	Recamier/Sims uterine curette sharp fig. 9; 19 mm; 31,0 cm	484
126 91 0043	Recamier/Sims kyreta ostrá ohebná; 20 mm; 31 cm	Recamier/Sims uterine curette sharp fig. 10; 20 mm; 31,0 cm	484
126 91 0044	Recamier/Sims kyreta ostrá ohebná; 21 mm; 31 cm	Recamier/Sims uterine curette sharp fig. 11; 21 mm; 31,0 cm	484
126 91 0045	Recamier/Sims kyreta ostrá ohebná; 23 mm; 31 cm	Recamier/Sims uterine curette sharp fig. 12; 23 mm; 31,0 cm	484
126 91 0046	Recamier/Sims kyreta ostrá ohebná; 5 mm; 26 cm	Recamier/Sims uterine curette sharp fig. 00; 5 mm; 26,0 cm	484
126 91 0047	Recamier/Sims kyreta ostrá ohebná; 6 mm; 26 cm	Recamier/Sims uterine curette sharp fig. 00; 6 mm; 26,0 cm	484
126 91 0048	Recamier/Sims kyreta ostrá ohebná; 7 mm; 26 cm	Recamier/Sims uterine curette sharp fig. 1; 7 mm; 26,0 cm	484
126 91 0049	Recamier/Sims kyreta ostrá ohebná; 8 mm; 26 cm	Recamier/Sims uterine curette sharp fig. 2; 8 mm; 26,0 cm	484
126 91 0050	Recamier/Sims kyreta ostrá ohebná; 9 mm; 26 cm	Recamier/Sims uterine curette sharp fig. 3; 9 mm; 26,0 cm	484
126 91 0051	Recamier/Sims kyreta ostrá ohebná; 11 mm; 26 cm	Recamier/Sims uterine curette sharp fig. 4; 11 mm; 26,0 cm	484

číslo – number	název	item	strana – page
126 91 0052	Recamier/Sims kyreta ostrá ohebná; 12 mm; 26 cm	Recamier/Sims uterine curette sharp fig. 5; 12 mm; 26.0 cm	484
126 91 0053	Recamier/Sims kyreta ostrá ohebná; 14 mm; 26 cm	Recamier/Sims uterine curette sharp fig. 6; 14 mm; 26.0 cm	484
126 91 0054	Recamier/Sims kyreta ostrá ohebná; 15 mm; 26 cm	Recamier/Sims uterine curette sharp fig. 7; 15 mm; 26.0 cm	484
126 91 0055	Recamier/Sims kyreta ostrá ohebná; 16 mm; 26 cm	Recamier/Sims uterine curette sharp fig. 8; 16 mm; 26.0 cm	484
126 91 0056	Recamier/Sims kyreta ostrá ohebná; 19 mm; 26 cm	Recamier/Sims uterine curette sharp fig. 9; 19 mm; 26.0 cm	484
126 91 0057	Recamier/Sims kyreta ostrá ohebná; 20 mm; 26 cm	Recamier/Sims uterine curette sharp fig. 10; 20 mm; 26.0 cm	484
126 91 0058	Recamier/Sims kyreta ostrá ohebná; 21 mm; 26 cm	Recamier/Sims uterine curette sharp fig. 11; 21 mm; 26.0 cm	484
126 91 0059	Recamier/Sims kyreta ostrá ohebná; 23 mm; 26 cm	Recamier/Sims uterine curette sharp fig. 12; 23 mm; 26.0 cm	484
126 91 0060	Sims/Recamier kyreta tupá ohebná; 5 mm; 31 cm	Sims/Recamier uterine curette blunt fig. 4; 5 mm; 31.0 cm	485
126 91 0061	Sims/Recamier kyreta tupá ohebná; 6 mm; 31 cm	Sims/Recamier uterine curette blunt fig. 4; 6 mm; 31.0 cm	485
126 91 0062	Sims/Recamier kyreta tupá ohebná; 7 mm; 31 cm	Sims/Recamier uterine curette blunt fig. 4; 7 mm; 31.0 cm	485
126 91 0063	Sims/Recamier kyreta tupá ohebná; 8 mm; 31 cm	Sims/Recamier uterine curette blunt fig. 4; 8 mm; 31.0 cm	485
126 91 0064	Sims/Recamier kyreta tupá ohebná; 9 mm; 31 cm	Sims/Recamier uterine curette blunt fig. 4; 9 mm; 31.0 cm	485
126 91 0065	Sims/Recamier kyreta tupá ohebná; 11 mm; 31 cm	Sims/Recamier uterine curette blunt fig. 4; 11 mm; 31.0 cm	485
126 91 0066	Sims/Recamier kyreta tupá ohebná; 12 mm; 31 cm	Sims/Recamier uterine curette blunt fig. 4; 12 mm; 31.0 cm	485
126 91 0067	Sims/Recamier kyreta tupá ohebná; 14 mm; 31 cm	Sims/Recamier uterine curette blunt fig. 4; 14 mm; 31.0 cm	485
126 91 0068	Sims/Recamier kyreta tupá ohebná; 15 mm; 31 cm	Sims/Recamier uterine curette blunt fig. 4; 15 mm; 31.0 cm	485
126 91 0069	Sims/Recamier kyreta tupá ohebná; 16 mm; 31 cm	Sims/Recamier uterine curette blunt fig. 4; 16 mm; 31.0 cm	485
126 91 0070	Sims/Recamier kyreta tupá ohebná; 19 mm; 31 cm	Sims/Recamier uterine curette blunt fig. 4; 19 mm; 31.0 cm	485
126 91 0071	Sims/Recamier kyreta tupá ohebná; 20 mm; 31 cm	Sims/Recamier uterine curette blunt fig. 4; 20 mm; 31.0 cm	485
126 91 0072	Sims/Recamier kyreta tupá ohebná; 21 mm; 31 cm	Sims/Recamier uterine curette blunt fig. 4; 21 mm; 31.0 cm	485
126 91 0073	Sims/Recamier kyreta tupá ohebná; 23 mm; 31 cm	Sims/Recamier uterine curette blunt fig. 4; 23 mm; 31.0 cm	485
126 91 0074	Sims/Recamier kyreta tupá ohebná; 5 mm; 26 cm	Sims/Recamier uterine curette blunt fig. 4; 5 mm; 26.0 cm	485
126 91 0075	Sims/Recamier kyreta tupá ohebná; 6 mm; 26 cm	Sims/Recamier uterine curette blunt fig. 4; 6 mm; 26.0 cm	485
126 91 0076	Sims/Recamier kyreta tupá ohebná; 7 mm; 26 cm	Sims/Recamier uterine curette blunt fig. 4; 7 mm; 26.0 cm	485
126 91 0077	Sims/Recamier kyreta tupá ohebná; 8 mm; 26 cm	Sims/Recamier uterine curette blunt fig. 4; 8 mm; 26.0 cm	485
126 91 0078	Sims/Recamier kyreta tupá ohebná; 9 mm; 26 cm	Sims/Recamier uterine curette blunt fig. 4; 9 mm; 26.0 cm	485
126 91 0079	Sims/Recamier kyreta tupá ohebná; 11 mm; 26 cm	Sims/Recamier uterine curette blunt fig. 4; 11 mm; 26.0 cm	485
126 91 0080	Sims/Recamier kyreta tupá ohebná; 12 mm; 26 cm	Sims/Recamier uterine curette blunt fig. 5; 12 mm; 26.0 cm	485
126 91 0081	Sims/Recamier kyreta tupá ohebná; 14 mm; 26 cm	Sims/Recamier uterine curette blunt fig. 6; 14 mm; 26.0 cm	485
126 91 0082	Sims/Recamier kyreta tupá ohebná; 15 mm; 26 cm	Sims/Recamier uterine curette blunt fig. 7; 15 mm; 26.0 cm	485
126 91 0083	Sims/Recamier kyreta tupá ohebná; 16 mm; 26 cm	Sims/Recamier uterine curette blunt fig. 8; 16 mm; 26.0 cm	485
126 91 0084	Sims/Recamier kyreta tupá ohebná; 19 mm; 26 cm	Sims/Recamier uterine curette blunt fig. 9; 19 mm; 26.0 cm	485
126 91 0085	Sims/Recamier kyreta tupá ohebná; 20 mm; 26 cm	Sims/Recamier uterine curette blunt fig. 4; 20 mm; 26.0 cm	485
126 91 0086	Sims/Recamier kyreta tupá ohebná; 21 mm; 26 cm	Sims/Recamier uterine curette blunt fig. 4; 21 mm; 26.0 cm	485
126 91 0087	Sims/Recamier kyreta tupá ohebná; 23 mm; 26 cm	Sims/Recamier uterine curette blunt fig. 4; 23 mm; 26.0 cm	485
126 91 0088	Collin kyreta děložní; 8,0 mm; 28,0 cm	Collin uterine curette; 8.0 mm; 28.0 cm	487
126 91 0089	Collin kyreta děložní; 10,0 mm; 28,0 cm	Collin uterine curette; 10.0 mm; 28.0 cm	487
126 91 0090	Collin kyreta děložní; 12,0 mm; 28,0 cm	Collin uterine curette; 12.0 mm; 28.0 cm	487
126 91 0091	Collin kyreta děložní; 14,0 mm; 28,0 cm	Collin uterine curette; 14.0 mm; 28.0 cm	487
126 91 0092	Blake kyreta děložní ostrá/tupá	Blake uterine curette sharp/blunt	487
126 91 0093	Doyen šroub na myomy; 17,0 cm	Doyen myoma instrument; 17.0 cm	490
126 91 0094	Doyen šroub na myomy; 17,0 cm	Doyen myoma instrument; 17.0 cm	490
126 91 0095	Randal kyreta sací pro biopsii; 24,0 cm	Randal suction biopsy curette; 24.0 cm	489
126 91 0099	Kevorkian kyreta sací pro biopsii; 30,0 cm	Kevorkian suction biopsy curette; 30.0 cm	489
126 91 0119	Billeau smyčka drátěná fig.1; 16,5 cm	Billeau loop fig.1; 16.5 cm	414
126 91 0120	Billeau smyčka drátěná fig.2; 16,5 cm	Billeau loop fig.2; 16.5 cm	414
126 91 0121	Billeau smyčka drátěná fig.3; 16,5 cm	Billeau loop fig.3; 16.5 cm	414
126 91 0122	Snellen smyčka drátěná fig.1; 16,5 cm	Snellen loop fig.1; 16.5 cm	414
126 91 0123	Snellen smyčka drátěná fig.2; 16,5 cm	Snellen loop fig.2; 16.5 cm	414
126 91 0124	Gross smyčka drátěná; 12,0 cm	Gross loop; 12.0 cm	414
126 91 0125	House kyreta ušní; 1,0x1,2 mm; 15,0 cm	House ear curette; 1.0x1.2 mm; 15.0 cm	412
126 91 0126	House kyreta ušní; 1,5x1,8 mm; 15,0 cm	House ear curette; 1.5x1.8 mm; 15.0 cm	412
126 91 0127	House kyreta ušní; 1,0x1,2 mm; 15,0 cm	House ear curette; 1.0x1.2 mm; 15.0 cm	412
126 91 0128	House kyreta ušní; 1,5x1,8 mm; 15,0 cm	House ear curette; 1.5x1.8 mm; 15.0 cm	412
126 91 0129	Shea kyreta ušní; 1,5x2,5 mm; 16,0 cm	Shea ear curette; 1.5x2.5 mm; 16.0 cm	412
126 91 0130	Shea kyreta ušní lomená; 1,5x2,5 mm; 16,0 cm	Shea ear curette angled; 1.5x2.5 mm; 16.0 cm	412
126 91 0131	Lempert kyreta fig.0; 17,5 cm	Lempert curette fig.0; 17.5 cm	412
126 91 0132	Lempert kyreta fig.00; 21,0 cm	Lempert curette fig.00; 21.0 cm	412
126 91 0133	Lempert kyreta fig.000; 21,0 cm	Lempert curette fig.000; 21.0 cm	412
126 91 0134	Lempert kyreta fig.0000; 21,0 cm	Lempert curette fig.0000; 21.0 cm	412
126 91 0135	Lempert kyreta fig.00000; 21,0 cm	Lempert curette fig.00000; 21.0 cm	412
126 91 0142	Coakley kyreta nosní ostrá fig.1; 17,0 cm	Coakley nasal curette sharp fig.1; 17.0 cm	414
126 91 0143	Coakley kyreta nosní ostrá fig.2; 17,0 cm	Coakley nasal curette sharp fig.2; 17.0 cm	414
126 91 0148	Faulkner kyreta nosní ostrá d/e; 21,0 cm	Faulkner nasal curette sharp d/e; 21.0 cm	414
126 91 0149	Sewall kyreta nosní ostrá; 20,0 cm	Sewall nasal curette sharp; 20.0 cm	414
126 91 0150	Buck kyreta ušní tupá zahnutá fig.000; 16,5 cm	Buck ear curette blunt curved fig.000; 16.5 cm	413
126 91 0151	Buck kyreta ušní tupá zahnutá fig.00; 16,5 cm	Buck ear curette blunt curved fig.00; 16.5 cm	413
126 91 0152	Buck kyreta ušní tupá zahnutá fig.0; 16,5 cm	Buck ear curette blunt curved fig.0; 16.5 cm	413
126 91 0153	Buck kyreta ušní tupá zahnutá fig.1; 16,5 cm	Buck ear curette blunt curved fig.1; 16.5 cm	413
126 91 0154	Buck kyreta ušní tupá zahnutá fig.2; 16,5 cm	Buck ear curette blunt curved fig.2; 16.5 cm	413
126 91 0155	Buck kyreta ušní tupá zahnutá fig.3; 16,5 cm	Buck ear curette blunt curved fig.3; 16.5 cm	413
126 91 0156	Buck kyreta ušní tupá zahnutá fig.4; 16,5 cm	Buck ear curette blunt curved fig.4; 16.5 cm	413
126 91 0157	Buck kyreta ušní tupá zahnutá fig.5; 16,5 cm	Buck ear curette blunt curved fig.5; 16.5 cm	413
126 91 0163	Kevorkian kyreta sací pro biopsii; 30,0 cm	Kevorkian suction biopsy curette; 30.0 cm	489
127 08 0030	Gutsch pilka rámová; 31,5 cm	Gutsch bone saw; 31.5 cm	284
127 08 0050	List pilky; 14 zubů na 1"; 16 mm; 26,5 cm	List of saw 14 teeth for 1"; 16 mm; 26.5 cm	284
127 08 0060	List pilky; 18 zubů na 1"; 16 mm; 26,5 cm	List of saw 18 teeth for 1"; 16 mm; 26.5 cm	284
127 08 0270	Škrabka vyhnutá; 15,9 cm	Rasp curved; 15.9 cm	418
127 17 0011	Olivercrone pilka drátěná; 32,0 cm	Olivercrone wire saw; 32.0 cm	559
127 17 0021	Olivercrone pilka drátěná; 40,0 cm	Olivercrone wire saw; 40.0 cm	559
127 17 0051	Držátko drátěných pilek pevné (pár); 8,0 cm	Hook handle (couple); 8.0 cm	559
127 30 0100	Joseph pilník nosní fig.1; 16,5 cm	Joseph nasal rasp fig.1; 16.5 cm	418
127 30 0110	Joseph pilník nosní fig.2; 16,5 cm	Joseph nasal rasp fig.2; 16.5 cm	418

číslo – number	název	item	strana – page
127 30 0120	Joseph pilník nosní fig.3; 16,5 cm	Joseph nasal rasp fig.3; 16.5 cm	418
127 91 0001	Wigmore pilka na sádrové obvazy; 19,0 cm	Wigmore plaster-of-paris saw; 19.0 cm	283
127 91 0002	Engel pilka na sádrové obvazy; 14,0 cm	Engel plaster-of-paris saw; 14.0 cm	283
127 91 0003	Elektrická pilka na sádrové obvazy; 220V	Oscillating plaster-saw; 220V	283
127 91 0004	Elektrická pilka na sádrové obvazy; 110V	Oscillating plaster-saw; 110V	283
127 91 0005	List pilky pro tvrdou sádru; 50 mm	Saw blade for hard plaster; 50 mm	283
127 91 0006	List pilky pro tvrdou sádru; 65 mm	Saw blade for hard plaster; 65 mm	283
127 91 0007	Klíč	Spanner only	283
127 91 0010	Joseph pilka nosní levá; 17,0 cm	Joseph nasal saw left; 17.0 cm	419
127 91 0011	Joseph pilka nosní pravá; 17,0 cm	Joseph nasal saw right; 17.0 cm	419
127 91 0012	Joseph pilka nosní rovná; 19,0 cm	Joseph nasal saws straight; 19.0 cm	419
127 91 0013	Joseph pilka nosní vlevo vyhnutá; 19,0 cm	Joseph nasal saw bay-shape left; 19.0 cm	419
127 91 0014	Joseph pilka nosní vpravo vyhnutá; 19,0 cm	Joseph nasal saw bay-shape right; 19.0 cm	419
127 91 0015	Lewis pilník nosní fig.1; 18,0 cm	Lewis nasal rasp fig.1; 18.0 cm	420
127 91 0016	Lewis pilník nosní fig.2; 18,0 cm	Lewis nasal rasp fig.2; 18.0 cm	420
127 91 0017	Cottle pilník nosní; 21,0 cm	Cottle nasal rasp; 21.0 cm	420
127 91 0018	Aufricht pilník nosní fig.1; 21,0 cm	Aufricht nasal rasp fig.1; 21.0 cm	420
127 91 0019	Aufricht pilník nosní fig.2; 21,0 cm	Aufricht nasal rasp fig.2; 21.0 cm	420
127 91 0020	Maltz pilník nosní; 18,0 cm	Maltz nasal rasp; 18.0 cm	420
127 91 0021	Gallagher pilník nosní rovný; 16,0 cm	Gallagher nasal rasp straight; 16.0 cm	420
127 91 0022	Gallagher pilník nosní zahnutý vlevo; 16,0 cm	Gallagher nasal rasp curved left; 16.0 cm	420
127 91 0023	Gallagher pilník nosní zahnutý vlevo; 16,0 cm	Gallagher nasal rasp curved left; 16.0 cm	420
127 91 0024	Wiener pilník nosní fig.1; 18,0 cm	Wiener nasal rasp fig.1; 18.0 cm	421
127 91 0025	Wiener pilník nosní fig.2; 18,0 cm	Wiener nasal rasp fig.2; 18.0 cm	421
127 91 0026	Converse pilník nosní; 18,5 cm	Converse nasal rasp; 18.5 cm	421
127 91 0027	Fomon pilník nosní; 21,0 cm	Fomon nasal rasp; 21.0 cm	421
127 91 0028	Masing pilník nosní; 21,0 cm	Masing nasal rasp; 21.0 cm	421
127 91 0029	Masing pilník nosní; 21,0 cm	Masing nasal rasp; 21.0 cm	421
127 91 0030	Miller-Colburn pilník nosní fig.1; 19,0 cm	Miller-Colburn nasal rasp fig.1; 19.0 cm	422
127 91 0031	Miller-Colburn pilník nosní fig.2; 19,0 cm	Miller-Colburn nasal rasp fig.2; 19.0 cm	422
127 91 0032	Miller-Colburn pilník nosní fig.3; 19,0 cm	Miller-Colburn nasal rasp fig.3; 19.0 cm	422
127 91 0033	Miller-Colburn pilník nosní fig.4; 19,0 cm	Miller-Colburn nasal rasp fig.4; 19.0 cm	422
127 91 0034	Miller-Colburn pilník nosní fig.5; 19,0 cm	Miller-Colburn nasal rasp fig.5; 19.0 cm	422
127 91 0035	Miller-Colburn pilník nosní fig.1; 19,0 cm	Miller-Colburn nasal rasp fig.1; 19.0 cm	422
127 91 0036	Miller-Colburn pilník nosní fig.2; 19,0 cm	Miller-Colburn nasal rasp fig.2; 19.0 cm	422
127 91 0037	Miller-Colburn pilník nosní fig.3; 19,0 cm	Miller-Colburn nasal rasp fig.3; 19.0 cm	422
127 91 0038	Miller-Colburn pilník nosní fig.4; 19,0 cm	Miller-Colburn nasal rasp fig.4; 19.0 cm	422
127 91 0039	Miller-Colburn pilník nosní fig.5; 19,0 cm	Miller-Colburn nasal rasp fig.5; 19.0 cm	422
127 91 0040	Lewis pilník nosní tvrdokovový fig. 1; 18,0 cm	Lewis nasal rasp fig.1 tuc; 18.0 cm	423
127 91 0041	Lewis pilník nosní tvrdokovový fig. 2; 18,0 cm	Lewis nasal rasp fig.2 tuc; 18.0 cm	423
127 91 0042	Cottle pilník nosní tvrdokovový; 21,0 cm	Cottle nasal rasp tuc; 21.0 cm	423
127 91 0043	Fomon pilník nosní tvrdokovový fig. 1; 20,0 cm	Fomon nasal rasp fig.1 tuc; 20.0 cm	423
127 91 0044	Fomon pilník nosní tvrdokovový fig. 2; 20,0 cm	Fomon nasal rasp fig.2 tuc; 20.0 cm	423
127 91 0045	Fomon pilník nosní tvrdokovový fig. 3; 20,0 cm	Fomon nasal rasp fig.3 tuc; 20.0 cm	423
127 91 0046	Fomon pilník nosní tvrdokovový fig. 4; 20,0 cm	Fomon nasal rasp fig.4 tuc; 20.0 cm	423
127 91 0047	Fomon pilník nosní tvrdokovový fig. 5; 20,0 cm	Fomon nasal rasp fig.5 tuc; 20.0 cm	423
127 91 0052	Pilník; 22,0 cm	Bone file; 22.0 cm	285
127 91 0053	Pilník; 24,5 cm	Bone file; 24.5 cm	285
127 91 0054	Pilník; 28,0 cm	Bone file; 28.0 cm	285
127 91 0055	Putti rašple; 27,0 cm	Putti rasp; 27.0 cm	285
127 91 0056	Putti rašple; 30,0 cm	Putti rasp; 30.0 cm	285
128 01 0030	Páka na lebku; 14,5 cm	Skull breaker; 14.5 cm	289
128 01 0050	Kladívko pitevni s hákem; 23,5 cm	Post mortem hammer with hook; 23.5 cm	290
128 08 0010	Stille dláto ploché; 205×10 mm	Stille chisel; 205×10 mm	292
128 08 0020	Stille dláto ploché; 205×12 mm	Stille chisel; 205×12 mm	292
128 08 0030	Stille dláto ploché; 205×15 mm	Stille chisel; 205×15 mm	292
128 08 0040	Stille dláto ploché; 205×20 mm	Stille chisel; 205×20 mm	292
128 08 0050	Stille dláto ploché; 205×25 mm	Stille chisel; 205×25 mm	292
128 08 0160	Stille dláto poloklínové; 205×15 mm	Stille chisel; 205×15 mm	292
128 08 0250	Dláto žlábkové obloukové; 205×10 mm	Gouge; 205×10 mm	292
128 08 0260	Dláto žlábkové obloukové; 205×15 mm	Gouge; 205×15 mm	292
128 08 0270	Dláto žlábkové obloukové; 205×20 mm	Gouge; 205×20 mm	292
128 08 0280	Dláto žlábkové obloukové; 205×25 mm	Gouge; 205×25 mm	292
128 08 0290	Dláto žlábkové obloukové; 205×30 mm	Gouge; 205×30 mm	292
128 08 0300	Dláto žlábkové rovné; 205×10 mm	Gouge; 205×10 mm	292
128 08 0310	Dláto žlábkové rovné; 205×15 mm	Gouge; 205×15 mm	292
128 08 0320	Dláto žlábkové rovné; 205×20 mm	Gouge; 205×20 mm	292
128 08 0330	Dláto žlábkové rovné; 205×25 mm	Gouge; 205×25 mm	292
128 08 0340	Dláto žlábkové rovné; 205×30 mm	Gouge; 205×30 mm	292
128 08 0350	Dláto žlábkové rovné; 205×35 mm	Gouge; 205×35 mm	292
128 08 0390	Dláto žlábkové obloukové; 205×35 mm	Gouge; 205×35 mm	292
128 08 0901	Kladívko chirurgické kovové; 250 g	Mallet metallic; 250 g	290; 433
128 08 0911	Kladívko chirurgické kovové; 500 g	Mallet metallic; 500 g	290
128 08 0921	Kladívko chirurgické kovové; 700 g	Mallet metallic; 700 g	290
128 08 1050	Stille dláto ploché; 205×6 mm	Stille chisel; 205×6 mm	292
128 08 1060	Stille dláto ploché; 205×8 mm	Stille chisel; 205×8 mm	292
128 09 0030	Naražeč kostních štěpů bajonetový; 8 mm; 260 mm	Bone graft driver; 8 mm; 260 mm	560
128 09 0040	Naražeč kostních štěpů; 9 mm; 210 mm	Bone graft driver; 9 mm; 210 mm	560
128 09 0200	Dláto ortopedické prohnuté; 16×250 mm	Gouge; 16×250 mm	561
128 12 0120	Dláto na nosní plastiku; 190×10 mm	Nasal plastic chisel; 190×10 mm	424; 433
128 12 0130	Dláto na nosní plastiku; 190×12 mm	Nasal plastic chisel; 190×12 mm	424; 433
128 12 0140	Dláto na nosní plastiku; 190×14 mm	Nasal plastic chisel; 190×14 mm	424
128 12 0160	Dláto na nosní plastiku fig.2; 180×4 mm	Nasal plastic chisel fig.2; 180×4 mm	424; 433
128 12 0170	Dláto na nosní plastiku fig.2; 180×6 mm	Nasal plastic chisel fig.2; 180×6 mm	424; 433



číslo – number	název	item	strana – page
128 12 0180	Dláto na nosní plastiku fig.2; 180x10 mm	Nasal plastic chisel fig.2; 180x10 mm	424
128 12 0200	Dláto na nosní plastiku fig.2; 180x8 mm	Nasal plastic chisel fig.2; 180x8 mm	424
128 30 0010	Dláto žlábkové nosní; 180x2 mm	Nasal gouge; 180x2 mm	424
128 30 0030	Dláto žlábkové nosní; 180x4 mm	Nasal gouge; 180x4 mm	424
128 30 0040	Dláto žlábkové nosní; 180x5 mm	Nasal gouge; 180x5 mm	424
128 30 0200	West dláto ploché nosní; 180x2 mm	West nasal chisel; 180x2 mm	424
128 30 0230	West dláto ploché nosní; 180x5 mm	West nasal chisel; 180x5 mm	424
128 91 0160	Freer dláto nosní; 16,0 cm	Freer nasal chisel; 16,0 cm	425
128 91 0161	Freer dláto nosní; 16,0 cm	Freer nasal chisel; 16,0 cm	425
128 91 0162	West dláto nosní; 16,0 cm	West nasal chisel; 16,0 cm	425
128 91 0163	West dláto nosní; 16,0 cm	West nasal chisel; 16,0 cm	425
128 91 0164	Freer dláto nosní; 15,0 cm	Freer nasal chisel; 15,0 cm	425
128 91 0165	Ballenger dláto nosní; 4,0 mm; 16,0 cm	Ballenger nasal chisel; 4,0 mm; 16,0 cm	425
128 91 0166	Ballenger dláto nosní; 6,0 mm; 16,0 cm	Ballenger nasal chisel; 6,0 mm; 16,0 cm	425
128 91 0167	Ballenger dláto nosní; 8,0 mm; 16,0 cm	Ballenger nasal chisel; 8,0 mm; 16,0 cm	425
128 91 0168	Killian-Claus dláto nosní; 16,0 cm	Killian-Claus nasal chisel; 16,0 cm	425
128 91 0169	Killian-Claus dláto nosní; 17,0 cm	Killian-Claus nasal chisel; 17,0 cm	425
128 91 0170	Cottle dláto nosní; 4,0 mm; 18,0 cm	Cottle osteotome; 4,0 mm; 18,0 cm	426
128 91 0171	Cottle dláto nosní; 7,0 mm; 18,0 cm	Cottle osteotome; 7,0 mm; 18,0 cm	426
128 91 0172	Cottle dláto nosní; 9,0 mm; 18,0 cm	Cottle osteotome; 9,0 mm; 18,0 cm	426
128 91 0173	Cottle dláto nosní; 12,0 mm; 18,0 cm	Cottle osteotome; 12,0 mm; 18,0 cm	426
128 91 0174	Cottle dláto nosní zahnuté; 6,0 mm; 18,0 cm	Cottle osteotome curved; 6,0 mm; 18,0 cm	426
128 91 0175	Cottle dláto nosní; 6,0 mm; 18,0 cm	Cottle osteotome; 6,0 mm; 18,0 cm	426
128 91 0176	Cottle dláto nosní; 4,0 mm; 18,0 cm	Cottle chisel; 4,0 mm; 18,0 cm	426
128 91 0177	Cottle dláto nosní; 7,0 mm; 18,0 cm	Cottle chisel; 7,0 mm; 18,0 cm	426
128 91 0178	Cottle dláto nosní; 9,0 mm; 18,0 cm	Cottle chisel; 9,0 mm; 18,0 cm	426
128 91 0179	Cottle dláto nosní; 12,0 mm; 18,0 cm	Cottle chisel; 12,0 mm; 18,0 cm	426
128 91 0180	Cottle dláto nosní; 16,0 mm; 18,0 cm	Cottle osteotome; 16,0 mm; 18,0 cm	426
128 91 0181	Cottle dláto nosní; 16,0 mm; 18,0 cm	Cottle osteotome; 16,0 mm; 18,0 cm	426
128 91 0182	Walter dláto nosní; 3 mm; 19,0 cm	Walter chisel; 3 mm; 19,0 cm	427
128 91 0183	Walter dláto nosní; 4,5 mm; 19,0 cm	Walter chisel; 4,5 mm; 19,0 cm	427
128 91 0184	Walter dláto nosní; 3 mm; 19,0 cm	Walter osteotome; 3 mm; 19,0 cm	427
128 91 0185	Walter dláto nosní; 4 mm; 19,0 cm	Walter osteotome; 4 mm; 19,0 cm	427
128 91 0186	Walter dláto nosní; 7 mm; 19,0 cm	Walter osteotome; 7 mm; 19,0 cm	427
128 91 0187	Walter dláto nosní; 9 mm; 19,0 cm	Walter osteotome; 9 mm; 19,0 cm	427
128 91 0188	Walter dláto nosní; 12 mm; 19,0 cm	Walter osteotome; 12 mm; 19,0 cm	427
128 91 0189	Sheehan dláto; 7 mm; 17,0 cm	Sheehan osteotome; 7 mm; 17,0 cm	427
128 91 0190	Sheehan dláto; 8 mm; 17,0 cm	Sheehan osteotome; 8 mm; 17,0 cm	427
128 91 0191	Sheehan dláto; 10 mm; 17,0 cm	Sheehan osteotome; 10 mm; 17,0 cm	427
128 91 0192	Sheehan dláto; 12 mm; 17,0 cm	Sheehan osteotome; 12 mm; 17,0 cm	427
128 91 0193	Rubin dláto; 10 mm; 18,0 cm	Rubin osteotome; 10 mm; 18,0 cm	427
128 91 0194	Rubin dláto; 12 mm; 18,0 cm	Rubin osteotome; 12 mm; 18,0 cm	427
128 91 0195	Rubin dláto; 14 mm; 18,0 cm	Rubin osteotome; 14 mm; 18,0 cm	427
128 91 0196	Cinelli dláto; 16 mm; 18,0 cm	Cinelli osteotome; 16 mm; 18,0 cm	427
128 91 0197	Masing dláto nosní; 17,5 cm	Masing chisel; 17,5 cm	428
128 91 0198	Masing dláto nosní rovné; 17,5 cm	Masing osteotome straight; 17,5 cm	428
128 91 0199	Masing dláto nosní fig.1; 17,5 cm	Masing osteotome fig.1; 17,5 cm	428
128 91 0200	Masing dláto nosní fig.2; 17,5 cm	Masing osteotome fig.2; 17,5 cm	428
128 91 0201	Silver dláto nosní rovné; 18,0 cm	Silver chisel straight; 18,0 cm	428
128 91 0202	Silver dláto nosní fig.0; 18,0 cm	Silver chisel fig.0; 18,0 cm	428
128 91 0203	Silver dláto nosní fig.2; 18,0 cm	Silver chisel fig.2; 18,0 cm	428
128 91 0204	Neivert dláto nosní rovné; 20,0 cm	Neivert chisel straight; 20,0 cm	428
128 91 0205	Anderson-Neivert dláto nosní fig.1; 20,0 cm	Anderson-Neivert chisel fig.1; 20,0 cm	428
128 91 0206	Anderson-Neivert dláto nosní fig.2; 20,0 cm	Anderson-Neivert chisel fig.2; 20,0 cm	428
128 91 0207	Converse dláto nosní fig.0; 19,0 cm	Converse chisel fig.0; 19,0 cm	428
128 91 0208	Converse dláto nosní fig.1; 19,0 cm	Converse chisel fig.1; 19,0 cm	428
128 91 0209	Converse dláto nosní fig.2; 19,0 cm	Converse chisel fig.2; 19,0 cm	428
128 91 0214	Lebsche nástroj na sternum; 25 cm	Lebsche sternum chisel; 25 cm	289
128 91 0237	Kladivo ortopedické; 450 g; 26,5 cm	Mallet orthopaedical; 450 g; 26,5 cm	291
128 91 0238	Kladivo ortopedické; 900 g; 26,5 cm	Mallet orthopaedical; 900 g; 26,5 cm	291
128 99 0015	Zatloukač úzký; 1,5 mm; 210 mm	Narrow punch; 1,5 mm; 210 mm	560
128 99 0031	Lambotte dláto neurochirurgické; 10x180 mm	Lambotte neurosurgical osteotome; 10x180 mm	561
128 99 0032	Lambotte dláto neurochirurgické; 15x180 mm	Lambotte neurosurgical osteotome; 15x180 mm	561
128 99 0033	Lambotte dláto neurochirurgické; 20x180 mm	Lambotte neurosurgical osteotome; 20x180 mm	561
128 99 0035	Lambotte dláto neurochirurgické; 25x180 mm	Lambotte neurosurgical osteotome; 25x180 mm	561
128 99 0036	Lambotte dláto neurochirurgické; 30x180 mm	Lambotte neurosurgical osteotome; 30x180 mm	561
128 99 0038	Lambotte dláto neurochirurgické; 40x180 mm	Lambotte neurosurgical osteotome; 40x180 mm	561
132 01 0050	Jehla šicí pitevní; 3 mm; 11,0 cm	Post mortem suturing needle; 3 mm; 11,0 cm	318
132 06 0200	Mathieu jehelec bez drážky; 14,0 cm	Mathieu needle holder; 14,0 cm	296
132 06 0220	Mathieu jehelec bez drážky; 17,0 cm	Mathieu needle holder; 17,0 cm	296
132 06 0300	Crile jehelec jemný; 15,0 cm	Crile needle holder; 15,0 cm	296
132 06 0341	Jehelec hloubkový rovný provlékací zámek; 16,5 cm	Needle holder; 16,5 cm	295
132 06 0370	Crile jehelec jemný diamantovaný; 1,6 mm; 15,5 cm	Crile needle holder dia; 1,6 mm; 15,5 cm	304
132 06 0450	Crile jehelec jemný provlékací zámek tvrdokov; 16,0 cm	Crile needle holder TUC; 16,0 cm	304
132 06 0500	Mathieu jehelec provlékací zámek tvrdokov; 17,0 cm	Mathieu needle holder TUC; 17,0 cm	303
132 06 0510	Mathieu jehelec provlékací zámek tvrdokov; 20,0 cm	Mathieu needle holder TUC; 20,0 cm	303
132 06 0520	Mathieu jehelec provlékací zámek tvrdokov; 14,0 cm	Mathieu needle holder TUC; 14,0 cm	303
132 06 0580	Jehelec jemný rovný s vyhnutým očkem tvrdokov; 13,0 cm	Needle holder with bent ring TUC; 13,0 cm	297
132 06 0590	Jehelec jemný rovný tvrdokov; 13,0 cm	Needle holder TUC; 13,0 cm	297
132 06 0600	Ryder/French-Eye jehelec tvrdokov; 16,5 cm	Ryder/French-Eye needle holder; 16,5 cm	299
132 06 0610	Jehelec hloubkový rovný tvrdokov; 16,0 cm	Needle holder TUC; 16,0 cm	297
132 06 0620	Jehelec hloubkový rovný tvrdokov; 20,0 cm	Needle holder TUC; 20,0 cm	297
132 06 0630	Jehelec hloubkový rovný tvrdokov; 26,0 cm	Needle holder TUC; 26,0 cm	297
132 06 0640	Ryder/French-Eye jehelec tvrdokov; 20,5 cm	Ryder/French-Eye needle holder; 20,5 cm	299

číslo – number	název	item	strana – page
132 06 0650	Ryder/French-Eye jehelec tvrdokov; 25,5 cm	Ryder/French-Eye needle holder; 25.5 cm	299
132 06 0710	Bozemann jehelec hloubk. prohnutý tvrdokov; 16,0 cm	Needle holder TUC; 16.0 cm	302
132 06 0720	Bozemann jehelec hloubk. prohnutý tvrdokov; 20,0 cm	Needle holder TUC; 20.0 cm	302; 434
132 06 0730	Bozemann jehelec hloubk. prohnutý tvrdokov; 25,0 cm	Needle holder TUC; 25.0 cm	302
132 06 0810	Jehelec s vnitřním uzávěrem vroubkovaným; 20,0 cm	Needle holder; 20.0 cm	296
132 06 0830	Jehelec s vnitřním uzávěrem tvrdokov; 20,0 cm	Needle holder TUC; 20.0 cm	304
132 12 0011	Jehelec pro plastiku prohnutý; 16,0 cm	Needle holder for plastic surgery; 16.0 cm	311
132 12 0020	Jehelec pro plastiku prohnutý; 21,0 cm	Needle holder for plastic surgery; 21.0 cm	311
132 17 0021	Jehelec neurochirurgický; 13,0 cm	Neurosurgical needle holder; 13.0 cm	311
132 38 0120	Boynton jehelec oční; 12,5 cm	Boynton eye needle holder; 12.5 cm	296
132 91 0030	Mayo-Hegar jehelec; 14,0 cm	Mayo-Hegar needle holder; 14.0 cm	295
132 91 0031	Mayo-Hegar jehelec; 16,0 cm	Mayo-Hegar needle holder; 16.0 cm	295
132 91 0032	Mayo-Hegar jehelec; 18,0 cm	Mayo-Hegar needle holder; 18.0 cm	295
132 91 0033	Mayo-Hegar jehelec; 20,0 cm	Mayo-Hegar needle holder; 20.0 cm	295
132 91 0034	Mayo-Hegar jehelec; 24,0 cm	Mayo-Hegar needle holder; 24.0 cm	295
132 91 0035	Mayo-Hegar jehelec; 26,0 cm	Mayo-Hegar needle holder; 26.0 cm	295
132 91 0036	Mayo-Hegar jehelec; 30,0 cm	Mayo-Hegar needle holder; 30.0 cm	295
132 91 0037	Mayo-Hegar-Delicate jehelec; 16,0 cm	Mayo-Hegar-Delicate needle holder; 16.0 cm	295
132 91 0038	Mayo-Hegar-Delicate jehelec; 18,0 cm	Mayo-Hegar-Delicate needle holder; 18.0 cm	295
132 91 0039	Mayo-Hegar-Delicate jehelec; 20,0 cm	Mayo-Hegar-Delicate needle holder; 20.0 cm	295
132 91 0040	Heaney jehelec zahnutý; 21,0 cm	Heaney needle holder; 21.0 cm	295
132 91 0050	Olsen-Hegar jehelec/nůžky; 14,0 cm	Olsen-Hegar needle holder/scissors; 14.0 cm	295
132 91 0051	Olsen-Hegar jehelec/nůžky; 17,0 cm	Olsen-Hegar needle holder/scissors; 17.0 cm	295
132 91 0052	Olsen-Hegar jehelec/nůžky; 19,0 cm	Olsen-Hegar needle holder/scissors; 19.0 cm	295
132 91 0056	Mathieu jehelec; 20,0 cm	Mathieu needle holder; 20.0 cm	296
132 91 0057	Mathieu jehelec; 24,0 cm	Mathieu needle holder; 24.0 cm	296
132 91 0096	Mayo-Hegar jehelec tvrdokov; 14,0 cm	Mayo-Hegar needle holder TUC; 14.0 cm	298
132 91 0097	Mayo-Hegar jehelec tvrdokov; 16,0 cm	Mayo-Hegar needle holder TUC; 16.0 cm	298; 433
132 91 0098	Mayo-Hegar jehelec tvrdokov; 18,0 cm	Mayo-Hegar needle holder TUC; 18.0 cm	298
132 91 0099	Mayo-Hegar jehelec tvrdokov; 20,0 cm	Mayo-Hegar needle holder TUC; 20.0 cm	298
132 91 0100	Mayo-Hegar jehelec tvrdokov; 24,0 cm	Mayo-Hegar needle holder TUC; 24.0 cm	298
132 91 0101	Mayo-Hegar jehelec tvrdokov; 26,0 cm	Mayo-Hegar needle holder TUC; 26.0 cm	298
132 91 0102	Mayo-Hegar jehelec tvrdokov; 30,0 cm	Mayo-Hegar needle holder TUC; 30.0 cm	298
132 91 0103	De Bakey jehelec tvrdokov; 18,0 cm	De Bakey needle holder TUC; 18.0 cm	298
132 91 0104	De Bakey jehelec tvrdokov; 20,0 cm	De Bakey needle holder TUC; 20.0 cm	298
132 91 0105	De Bakey jehelec tvrdokov; 23,0 cm	De Bakey needle holder TUC; 23.0 cm	298
132 91 0106	De Bakey jehelec tvrdokov; 26,0 cm	De Bakey needle holder TUC; 26.0 cm	298
132 91 0107	De Bakey jehelec tvrdokov; 31,0 cm	De Bakey needle holder TUC; 31.0 cm	298
132 91 0108	Ryder/French-Eye jehelec oční tvrdokov; 13,0 cm	Ryder/French-Eye needle holder TUC; 13.0 cm	299
132 91 0120	Eufate Pasque jehelec tvrdokov; 14,0 cm	Eufate Pasque needle holder TUC; 14.0 cm	299
132 91 0121	Eufate Pasque jehelec tvrdokov; 18,0 cm	Eufate Pasque needle holder TUC; 18.0 cm	299
132 91 0122	Eufate Pasque jehelec tvrdokov; 20,0 cm	Eufate Pasque needle holder TUC; 20.0 cm	299
132 91 0123	Eufate Pasque jehelec tvrdokov; 23,0 cm	Eufate Pasque needle holder TUC; 23.0 cm	299
132 91 0124	Microvascular jehelec tvrdokov; 14,0 cm	Microvascular needle holder TUC; 14.0 cm	299
132 91 0125	Microvascular jehelec tvrdokov; 18,0 cm	Microvascular needle holder TUC; 18.0 cm	299
132 91 0126	Microvascular jehelec tvrdokov; 20,0 cm	Microvascular needle holder TUC; 20.0 cm	299
132 91 0127	Microvascular jehelec tvrdokov; 23,0 cm	Microvascular needle holder TUC; 23.0 cm	299
132 91 0130	New Orleans jehelec tvrdokov; 18,0 cm	New Orleans needle holder TUC; 18.0 cm	300
132 91 0131	Senning (Swed. Mod) jehelec tvrdokov; 15,0 cm	Senning (Swed. Mod) needle holder TUC; 15.0 cm	300
132 91 0132	Senning (Swed. Mod) jehelec tvrdokov; 17,0 cm	Senning (Swed. Mod) needle holder TUC; 17.0 cm	300
132 91 0133	Derf jehelec tvrdokov; 12,5 cm	Derf needle holder TUC; 12.5 cm	300
132 91 0135	Kilner jehelec s-prohnutý tvrdokov; 13,5 cm	Kilner needle holder TUC; 13.5 cm	300
132 91 0137	Webster jehelec tvrdokov; 13,0 cm	Webster needle holder TUC; 13.0 cm	301
132 91 0138	Halsey jehelec tvrdokov hladký; 13,0 cm	Halsey needle holder TUC; 13.0 cm	301
132 91 0139	Halsey jehelec tvrdokov; 13,0 cm	Halsey needle holder TUC; 13.0 cm	301
132 91 0140	Baby-Crile-Wood jehelec tvrdokov; 15,0 cm	Baby-Crile-Wood needle holder TUC; 15.0 cm	301; 435
132 91 0142	Crile-Wood jehelec tvrdokov; 15,0 cm	Crile-Wood needle holder TUC; 15.0 cm	301
132 91 0143	Crile-Wood jehelec tvrdokov; 18,0 cm	Crile-Wood needle holder TUC; 18.0 cm	301
132 91 0144	Crile-Wood jehelec tvrdokov; 20,0 cm	Crile-Wood needle holder TUC; 20.0 cm	301
132 91 0145	Crile-Wood jehelec tvrdokov; 23,0 cm	Crile-Wood needle holder TUC; 23.0 cm	301
132 91 0148	Finochietto jehelec tvrdokov; 27,0 cm	Finochietto needle holder TUC; 27.0 cm	302
132 91 0149	Wangensteen jehelec tvrdokov; 27,0 cm	Wangensteen needle holder TUC; 27.0 cm	302
132 91 0154	Sarot jehelec tvrdokov; 18,0 cm	Sarot needle holder TUC; 18.0 cm	302
132 91 0155	Sarot jehelec tvrdokov; 26,0 cm	Sarot needle holder TUC; 26.0 cm	302
132 91 0156	Masson jehelec tvrdokov; 27,0 cm	Masson needle holder TUC; 27.0 cm	302
132 91 0160	Olsen-Hegar jehelec/nůžky tvrdokov; 14,0 cm	Olsen-Hegar needle holder/scissors TUC; 14.0 cm	303
132 91 0161	Olsen-Hegar jehelec/nůžky tvrdokov; 17,0 cm	Olsen-Hegar needle holder/scissors TUC; 17.0 cm	303
132 91 0162	Olsen-Hegar jehelec/nůžky tvrdokov; 19,0 cm	Olsen-Hegar needle holder/scissors TUC; 19.0 cm	303
132 91 0167	Mathieu jehelec tvrdokov; 24,0 cm	Mathieu needle holder TUC; 24.0 cm	303
132 91 0168	Mathieu jehelec jemný tvrdokov; 17,0 cm	Mathieu needle holder TUC; 17.0 cm	303
132 91 0169	Mathieu jehelec jemný tvrdokov; 20,0 cm	Mathieu needle holder TUC; 20.0 cm	303
132 91 0170	Mathieu jehelec jemný tvrdokov; 23,0 cm	Mathieu needle holder TUC; 23.0 cm	303
132 91 0174	Metzenbaum jehelec zahnutý tvrdokov; 17,0 cm	Metzenbaum needle holder curved TUC; 17.0 cm	304
132 91 0175	Metzenbaum jehelec zahnutý tvrdokov; 19,5 cm	Metzenbaum needle holder curved TUC; 19.5 cm	304
132 91 0176	Mathieu-Ryder jehelec tvrdokov; 17,0 cm	Mathieu-Ryder needle holder TUC; 17.0 cm	304
132 91 0177	Mathieu-Ryder jehelec tvrdokov; 20,0 cm	Mathieu-Ryder needle holder TUC; 20.0 cm	304
132 91 0182	Boynton jehelec oční tvrdokov; 12,5 cm	Boynton eye needle holder; 12.5 cm	305
132 91 0186	Hösel jehelec tvrdokov; 25,0 cm	Hoesel needle holder TUC; 25.0 cm	305
132 91 0192	Luethy-Beck jehelec tvrdokov; 20,0 cm	Luethy-Beck needle holder TUC; 20.0 cm	305
132 91 0194	Langenbeck jehelec tvrdokov; 18,0 cm	Langenbeck needle holder TUC; 18.0 cm	305
132 91 0195	Langenbeck jehelec tvrdokov; 20,0 cm	Langenbeck needle holder TUC; 20.0 cm	305
132 91 0196	Langenbeck-Delicate jehelec tvrdokov; 18,0 cm	Langenbeck-Delicate needle holder TUC; 18.0 cm	305
132 91 0197	Langenbeck-Delicate jehelec tvrdokov; 20,0 cm	Langenbeck-Delicate needle holder TUC; 20.0 cm	305
132 91 0199	Langenbeck-Ryder jehelec tvrdokov; 18,0 cm	Langenbeck-Ryder needle holder TUC; 18.0 cm	305

číslo – number	název	item	strana – page
132 91 0200	Langenbeck-Ryder jehelec tvrdokov; 20,0 cm	Langenbeck-Ryder needle holder TUC; 20,0 cm	305
132 91 0202	Sternum jehelec tvrdokov; 13,0 cm	Sternum needle holder TUC; 13,0 cm	306
132 91 0203	Sternum jehelec tvrdokov; 18,0 cm	Sternum needle holder TUC; 18,0 cm	306
132 91 0206	Berry jehelec tvrdokov; 18,5 cm	Berry wire twisting forceps TUC; 18,5 cm	306
132 91 0213	Castroviejo jehelec rovný hladký tvrdokov; 14,0 cm	Castroviejo needle holder straight TUC; 14,0 cm	306
132 91 0214	Castroviejo jehelec zahnutý hladký tvrdokov; 14,0 cm	Castroviejo needle holder curved TUC; 14,0 cm	306
132 91 0215	Castroviejo jehelec rovný vroubkovaný tvrdokov; 14,0 cm	Castroviejo needle holder straight TUC; 14,0 cm	306
132 91 0216	Castroviejo jehelec zahnutý vroubkovaný tvrdokov; 14,0 cm	Castroviejo needle holder TUC; 14,0 cm	306
132 91 0217	Castroviejo jehelec rovný hladký tvrdokov; 18,0 cm	Castroviejo micro-needle holder TUC; 18,0 cm	307
132 91 0218	Castroviejo jehelec zahnutý hladký tvrdokov; 18,0 cm	Castroviejo micro-needle holder TUC; 18,0 cm	307
132 91 0219	Castroviejo jehelec rovný vroubkovaný tvrdokov; 18,0 cm	Castroviejo micro-needle holder TUC; 18,0 cm	307
132 91 0220	Castroviejo jehelec zahnutý vroubkovaný tvrdokov; 18,0 cm	Castroviejo micro-needle holder TUC; 18,0 cm	307
132 91 0221	Jacobson jehelec mikro hladký tvrdokov; 21,0 cm	Jacobson micro-needle holder TUC; 21,0 cm	307
132 91 0222	Jacobson jehelec mikro vroubkovaný tvrdokov; 21,0 cm	Jacobson micro-needle holder TUC; 21,0 cm	307
132 91 0223	Diethrich jehelec mikro tvrdokov; 16,0 cm	Diethrich micro-needle holder TUC; 16,0 cm	307
132 91 0224	Diethrich jehelec mikro tvrdokov; 18,0 cm	Diethrich micro-needle holder TUC; 18,0 cm	307
132 91 0225	Diethrich jehelec mikro tvrdokov; 20,0 cm	Diethrich micro-needle holder TUC; 20,0 cm	307
132 91 0226	Diethrich jehelec mikro tvrdokov; 23,0 cm	Diethrich micro-needle holder TUC; 23,0 cm	307
132 91 0227	Diethrich jehelec mikro tvrdokov; 26,0 cm	Diethrich micro-needle holder TUC; 26,0 cm	307
132 91 0229	Castroviejo jehelec mikro hladký tvrdokov; 13,0 cm	Castroviejo needle holder TUC; 13,0 cm	307
132 91 0230	Potts-Smith jehelec mikro tvrdokov; 22,0 cm	Potts-Smith micro-needle holder TUC; 22,0 cm	307
132 91 0249	Barraquer jehelec mikro rovný; 18,0 cm	Barraquer micro-needle holder straight; 18,0 cm	308
132 91 0250	Barraquer jehelec mikro zahnutý; 18,0 cm	Barraquer micro-needle holder curved; 18,0 cm	308
132 91 0251	Barraquer jehelec mikro rovný s uzávěrem; 18,0 cm	Barraquer micro-needle holder straight; 18,0 cm	308
132 91 0252	Barraquer jehelec mikro zahnutý s uzávěrem; 18,0 cm	Barraquer micro-needle holder curved; 18,0 cm	308
132 91 0253	Castroviejo jehelec mikro rovný; 9,0 cm	Castroviejo micro-needle holder straight; 9,0 cm	309
132 91 0254	Castroviejo jehelec mikro zahnutý; 9,0 cm	Castroviejo micro-needle holder curved; 9,0 cm	309
132 91 0255	Castroviejo jehelec mikro rovný s uzávěrem; 9,0 cm	Castroviejo micro-needle holder straight; 9,0 cm	309
132 91 0256	Castroviejo jehelec mikro zahnutý s uzávěrem; 9,0 cm	Castroviejo micro-needle holder curved; 9,0 cm	309
132 91 0257	Castroviejo jehelec mikro rovný hladký; 14,0 cm	Castroviejo micro-needle holder straight; 14,0 cm	309
132 91 0258	Castroviejo jehelec mikro zahnutý hladký; 14,0 cm	Castroviejo micro-needle holder curved; 14,0 cm	309
132 91 0259	Castroviejo jehelec mikro rovný vroubkovaný; 14,0 cm	Castroviejo micro-needle holder straight; 14,0 cm	309
132 91 0260	Castroviejo jehelec mikro zahnutý vroubkovaný; 14,0 cm	Castroviejo micro-needle holder curved; 14,0 cm	309
132 91 0261	Castroviejo jehelec rovný hladký s uzávěrem; 14,0 cm	Castroviejo micro-needle holder straight; 14,0 cm	309
132 91 0262	Castroviejo jehelec zahnutý hladký s uzávěrem; 14,0 cm	Castroviejo micro-needle holder curved; 14,0 cm	309
132 91 0263	Castroviejo jehelec rovný vroubk. s uzávěrem; 14,0 cm	Castroviejo micro-needle holder straight; 14,0 cm	309
132 91 0264	Castroviejo jehelec zahnutý vroubk. s uzávěrem; 14,0 cm	Castroviejo micro-needle holder curved; 14,0 cm	309
132 91 0269	Jacobson jehelec mikro s uzávěrem; 18,0 cm	Jacobson micro-needle holder; 18,0 cm	309
132 91 0270	Jacobson jehelec mikro s uzávěrem; 21,0 cm	Jacobson micro-needle holder; 21,0 cm	309
132 91 0271	Jehelec mikro rovný bajonetový; 16,5 cm	Micro-needle holder straight; 16,5 cm	310
132 91 0272	Jehelec mikro rovný bajonetový; 18,0 cm	Micro-needle holder straight; 18,0 cm	310
132 91 0273	Jehelec mikro rovný bajonetový; 20,0 cm	Micro-needle holder straight; 20,0 cm	310
132 91 0274	Jehelec mikro rovný bajonetový; 22,0 cm	Micro-needle holder straight; 22,0 cm	310
132 91 0275	Jehelec mikro zahnutý bajonetový; 16,5 cm	Micro-needle holder curved; 16,5 cm	310
132 91 0276	Jehelec mikro zahnutý bajonetový; 18,0 cm	Micro-needle holder curved; 18,0 cm	310
132 91 0277	Jehelec mikro zahnutý bajonetový; 20,0 cm	Micro-needle holder curved; 20,0 cm	310
132 91 0278	Jehelec mikro zahnutý bajonetový; 22,0 cm	Micro-needle holder curved; 22,0 cm	310
132 91 0297	Reverdin jehla fig. 1; 14,0 cm	Reverdin needle fig.1; 14,0 cm	313
132 91 0298	Reverdin jehla fig. 2; 14,0 cm	Reverdin needle fig.2; 14,0 cm	313
132 91 0299	Reverdin jehla fig. 3; 14,0 cm	Reverdin needle fig.3; 14,0 cm	313
132 91 0300	Reverdin jehla fig. 4; 14,0 cm	Reverdin needle fig.4; 14,0 cm	313
132 91 0301	Reverdin jehla fig. 1; 19,5 cm	Reverdin needle fig.1; 19,5 cm	313
132 91 0302	Reverdin jehla fig. 2; 19,5 cm	Reverdin needle fig.2; 19,5 cm	313
132 91 0303	Reverdin jehla fig. 3; 19,5 cm	Reverdin needle fig.3; 19,5 cm	313
132 91 0304	Reverdin jehla fig. 4; 19,5 cm	Reverdin needle fig.4; 19,5 cm	313
132 91 0305	Reverdin jehla fig. 1; 22,5 cm	Reverdin needle fig.1; 22,5 cm	313
132 91 0306	Reverdin jehla fig. 2; 22,5 cm	Reverdin needle fig.2; 22,5 cm	313
132 91 0307	Reverdin jehla fig. 3; 22,5 cm	Reverdin needle fig.3; 22,5 cm	313
132 91 0308	Reverdin jehla fig. 4; 22,5 cm	Reverdin needle fig.4; 22,5 cm	313
132 91 0309	Deschamps jehla podvazovací ostrá malá levá; 20,0 cm	Deschamps ligature needle pointed small left; 20,0 cm	314; 435
132 91 0310	Deschamps jehla podvazovací ostrá malá pravá; 20,0 cm	Deschamps ligature needle pointed small right; 20,0 cm	314
132 91 0311	Deschamps jehla podvazovací ostrá střední pravá; 20,0 cm	Deschamps ligature needle pointed medium right; 20,0 cm	314
132 91 0312	Deschamps jehla podvazovací ostrá střední levá; 20,0 cm	Deschamps ligature needle pointed medium left; 20,0 cm	314
132 91 0313	Deschamps jehla podvazovací ostrá velká levá; 21,0 cm	Deschamps ligature needle pointed large left; 21,0 cm	314
132 91 0314	Deschamps jehla podvazovací ostrá velká pravá; 21,0 cm	Deschamps ligature needle pointed large right; 21,0 cm	314
132 91 0315	Deschamps jehla podvazovací ostrá velká pravá; 21,0 cm	Deschamps ligature needle pointed large right; 21,0 cm	314
132 91 0316	Deschamps jehla podvazovací ostrá velká pravá; 27,0 cm	Deschamps ligature needle pointed large right; 27,0 cm	314
132 91 0317	Deschamps jehla podvazovací tupá malá levá; 20,0 cm	Deschamps ligature needle blunt small left; 20,0 cm	314
132 91 0318	Deschamps jehla podvazovací tupá malá pravá; 20,0 cm	Deschamps ligature needle blunt small right; 20,0 cm	314
132 91 0319	Deschamps jehla podvazovací tupá střední pravá; 20,0 cm	Deschamps ligature needle blunt medium right; 20,0 cm	314
132 91 0320	Deschamps jehla podvazovací tupá střední levá; 20,0 cm	Deschamps ligature needle blunt medium left; 20,0 cm	314
132 91 0321	Deschamps jehla podvazovací tupá velká levá; 21,0 cm	Deschamps ligature needle blunt large left; 21,0 cm	314
132 91 0322	Deschamps jehla podvazovací tupá velká levá; 27,0 cm	Deschamps ligature needle blunt large left; 27,0 cm	314
132 91 0323	Deschamps jehla podvazovací tupá velká pravá; 21,0 cm	Deschamps ligature needle blunt large right; 21,0 cm	314
132 91 0324	Deschamps jehla podvazovací tupá velká pravá; 27,0 cm	Deschamps ligature needle blunt large right; 27,0 cm	314
132 91 0353	Brunner jehla podvazovací fig.1; 30,0 cm	Brunner ligature needle fig.1; 30,0 cm	315
132 91 0354	Brunner jehla podvazovací fig.2; 30,0 cm	Brunner ligature needle fig.1; 30,0 cm	315
132 91 0358	Payr jehla podvazovací rovná; 22,0 cm	Payr ligature needle; 22,0 cm	316
132 91 0359	Payr jehla podvazovací zahnutá; 22,0 cm	Payr ligature needle; 22,0 cm	316
132 91 0360	Schmieden-Payr jehla podvazovací fig.1; 19,0 cm	Schmieden-Payr ligature needle; 19,0 cm	316
132 91 0361	Schmieden-Payr jehla podvazovací fig.2; 19,0 cm	Schmieden-Payr ligature needle; 19,0 cm	316
132 91 0362	König jehla podvazovací; 3 mm; 19,5 cm	König ligature needle; 3 mm; 19,5 cm	316
132 91 0363	König jehla podvazovací; 5 mm; 19,5 cm	König ligature needle; 5 mm; 19,5 cm	316
132 91 0364	König jehla podvazovací; 7 mm; 19,5 cm	König ligature needle; 7 mm; 19,5 cm	316



číslo – number	název	item	strana – page
132 91 0365	Kirschner jehla podvazovací; 25,5 cm	Kirschner ligature needle; 25.5 cm	315
132 91 0366	Kirschner jehla podvazovací; 28,0 cm	Kirschner ligature needle; 28.0 cm	315
132 91 0382	Michel svorka šicí; 12,0 cm	Michel clip forceps; 12.0 cm	317
132 91 0383	Collin svorka šicí; 13,0 cm	Collin clip forceps; 13.0 cm	317
132 91 0386	Hegenbarth pinzeta šicí; 12,5 cm	Hegenbarth suture forceps; 12.5 cm	317
132 91 0387	Michel pinzeta šicí; 12,0 cm	Michel suture forceps; 12.0 cm	317
132 91 0399	Finochietto jehelec; 20,0 cm	Finochietto needle holder; 20.0 cm	302
132 91 0415	Barraquer jehelec mikro rovný; 0,3 mm; 14,0 cm	Barraquer micro needle holder straight; 0.3 mm; 14.0 cm	312
132 91 0416	Barraquer jehelec mikro rovný; 0,3 mm; 18,0 cm	Barraquer micro needle holder straight; 0.3 mm; 18.0 cm	312
132 91 0417	Barraquer jehelec mikro zahnutý; 0,3 mm; 14,0 cm	Barraquer micro needle holder curved; 0.3 mm; 14.0 cm	312
132 91 0418	Barraquer jehelec mikro zahnutý; 0,3 mm; 18,0 cm	Barraquer micro needle holder curved; 0.3 mm; 18.0 cm	312
132 91 0419	Barraquer jehelec mikro rovný; 0,8 mm; 14,0 cm	Barraquer micro needle holder straight; 0.8 mm; 14.0 cm	312
132 91 0420	Barraquer jehelec mikro rovný; 0,8 mm; 18,0 cm	Barraquer micro needle holder straight; 0.8 mm; 18.0 cm	312
132 91 0421	Barraquer jehelec mikro zahnutý; 0,8 mm; 14,0 cm	Barraquer micro needle holder curved; 0.8 mm; 14.0 cm	312
132 91 0422	Barraquer jehelec mikro zahnutý; 0,8 mm; 18,0 cm	Barraquer micro needle holder curved; 0.8 mm; 18.0 cm	312
132 91 0423	Barraquer jehelec mikro rovný; 0,3 mm; 14,0 cm	Barraquer micro needle holder straight; 0.3 mm; 14.0 cm	312
132 91 0424	Barraquer jehelec mikro rovný; 0,3 mm; 18,0 cm	Barraquer micro needle holder straight; 0.3 mm; 18.0 cm	312
132 91 0425	Barraquer jehelec mikro zahnutý; 0,3 mm; 14,0 cm	Barraquer micro needle holder curved; 0.3 mm; 14.0 cm	312
132 91 0426	Barraquer jehelec mikro zahnutý; 0,3 mm; 18,0 cm	Barraquer micro needle holder curved; 0.3 mm; 18.0 cm	312
132 91 0427	Barraquer jehelec mikro rovný; 0,8 mm; 14,0 cm	Barraquer micro needle holder straight; 0.8 mm; 14.0 cm	312
132 91 0428	Barraquer jehelec mikro rovný; 0,8 mm; 18,0 cm	Barraquer micro needle holder straight; 0.8 mm; 18.0 cm	312
132 91 0429	Barraquer jehelec mikro zahnutý; 0,8 mm; 14,0 cm	Barraquer micro needle holder curved; 0.8 mm; 14.0 cm	312
132 91 0430	Barraquer jehelec mikro zahnutý; 0,8 mm; 18,0 cm	Barraquer micro needle holder curved; 0.8 mm; 18.0 cm	312
132 91 0439	Jehelec mikro rovný dia; 15,0 cm	Diamond needle holder straight; 15.0 cm	311
132 91 0440	Jehelec mikro rovný dia; 18,0 cm	Diamond needle holder straight; 18.0 cm	311
132 91 0441	Jehelec mikro rovný dia; 23,0 cm	Diamond needle holder straight; 23.0 cm	311
133 08 0020	Pátradlo paličkové oboustranné; 14,0 cm	Probe olive; 14.0 cm	321
133 08 0050	Pátradlo paličkové oboustranné; 20,0 cm	Probe olive; 20.0 cm	321
133 08 0060	Pátradlo paličkové oboustranné; 25,0 cm	Probe olive; 25.0 cm	321
133 08 0090	Pátradlo žlábkové; 14,0 cm	Probe; 14.0 cm	321
133 08 0100	Pátradlo paličkové s dlátkem; 14,0 cm	Probe olive with chisel; 14.0 cm	321
133 08 0110	Pátradlo paličkové s dlátkem; 20,0 cm	Probe olive with chisel; 20.0 cm	321
133 08 0140	Pátradlo paličkové; 14,0 cm	Probe; 14.0 cm	321
133 17 0061	Zavaděč drátěných pilek	Conductor for wire saws	559
133 17 0070	Zavaděč drátěných pilek	Conductor for wire saws	559
133 20 0010	Desjardines pátradlo na žlučovod; 4 mm; 27,0 cm	Desjardines gall duct probe; 4 mm; 27.0 cm	322
133 20 0020	Desjardines pátradlo na žlučovod; 5 mm; 27,0 cm	Desjardines gall duct probe; 5 mm; 27.0 cm	322
133 20 0050	Bakeš sada pátradel na žlučovod	Bakeš gall duct probes set	322
133 20 0070	Bakeš pátradlo na žlučovod; 2,5 mm; 17,0 cm	Bakeš gall duct probe; 2.5 mm; 17.0 cm	322
133 20 0080	Bakeš pátradlo na žlučovod; 3,0 mm; 18,0 cm	Bakeš gall duct probe; 3.0 mm; 18.0 cm	322
133 20 0090	Bakeš pátradlo na žlučovod; 4,0 mm; 17,3 cm	Bakeš gall duct probe; 4.0 mm; 17.3 cm	322
133 20 0100	Bakeš pátradlo na žlučovod; 5,0 mm; 21,5 cm	Bakeš gall duct probe; 5.0 mm; 21.5 cm	322
133 20 0110	Bakeš pátradlo na žlučovod; 6,0 mm; 22,8 cm	Bakeš gall duct probe; 6.0 mm; 22.8 cm	322
133 20 0120	Bakeš pátradlo na žlučovod; 7,0 mm; 19,0 cm	Bakeš gall duct probe; 7.0 mm; 19.0 cm	322
133 20 0130	Bakeš pátradlo na žlučovod; 8,0 mm; 24,0 cm	Bakeš gall duct probe; 8.0 mm; 24.0 cm	322
133 20 0140	Bakeš pátradlo na žlučovod; 9,0 mm; 25,2 cm	Bakeš gall duct probe; 9.0 mm; 25.2 cm	322
133 22 0170	Sonda urologická s olivkami oboustr.; 12-14-18-16 ch; 19,6 cm	Urological probe with olives; 12-14-18-16 ch; 19.6 cm	324
133 22 0180	Sonda urologická s olivkami oboustr.; 20-22-26-24 ch; 19,6 cm	Urological probe with olives; 20-22-26-24 ch; 19.6 cm	324
133 22 0190	Sonda urologická s olivkami oboustr.; 14-16-20-18 ch; 20,6 cm	Urological probe with olives; 14-16-20-18 ch; 20.6 cm	324
133 22 0200	Sonda urologická s olivkami oboustr.; 22-24-28-26 ch; 20,6 cm	Urological probe with olives; 22-24-28-26 ch; 20.6 cm	324
133 27 0011	Sims pátradlo děložní; 3,5 mm; 36,5 cm	Sims uterine probe; 3.5 mm; 36.5 cm	492
133 27 0130	Pátradlo děložní jemné; 2,4 mm; 28,0 cm	Uterine probe; 2.4 mm; 28.0 cm	492
133 29 0010	Pátradlo ušní; 1,0 mm; 9,5 cm	Aural probe; 1.0 mm; 9.5 cm	431
133 29 0110	Drátek pro výtěry; 0,8 mm; 14,0 cm	Swab wire; 0.8 mm; 14.0 cm	431
133 30 0030	Pátradlo nosní; 1,6 mm; 13,7 cm	Nasal probe; 1.6 mm; 13.7 cm	431
133 35 0010	Kocher pátradlo na strumu; 15,0 cm	Kocher goitre probe; 15.0 cm	431
133 38 0060	Bowmann pátradlo oční; 0,5 mm; 13,0 cm	Bowmann eye probe; 0.5 mm; 13.0 cm	325
133 38 0070	Bowmann pátradlo oční; 0,7 mm; 13,0 cm	Bowmann eye probe; 0.7 mm; 13.0 cm	325
133 38 0080	Bowmann pátradlo oční; 0,9 mm; 13,0 cm	Bowmann eye probe; 0.9 mm; 13.0 cm	325
133 38 0110	Dilatátor slzných bodů; 0,1 mm; 7,5 cm	Eye dilator; 0.1 mm; 7.5 cm	325
133 38 0120	Dilatátor slzných bodů; 0,25 mm; 7,5 cm	Eye dilator; 0.25 mm; 7.5 cm	325
133 38 0130	Dilatátor slzných bodů; 0,4 mm; 7,5 cm	Eye dilator; 0.4 mm; 7.5 cm	325
133 91 0059	Nabatoff soubor sond na křečové žíly	Nabatoff varicose vein probe set complete	323
133 91 0060	Sonda kovová; 3,0 mm	Probe tip only metal; 3.0 mm	323
133 91 0061	Olivka; 6,0 mm	Olive; 6.0 mm	323
133 91 0062	Olivka; 9,0 mm	Olive; 9.0 mm	323
133 91 0063	Olivka; 12,0 mm	Olive; 12.0 mm	323
133 91 0064	Držátko	Handle only	323
133 91 0065	Zavaděč nerezový	Cable flexible stainless	323
133 91 0066	Sonda plastová	Probe tip plastic material	323
133 91 0067	Garrett sonda cévní ohebná; 1,0 mm; 14,0 cm	Garrett vascular dilatator malleable; 1.0 mm; 14.0 cm	323
133 91 0068	Garrett sonda cévní ohebná; 1,5 mm; 14,0 cm	Garrett vascular dilatator malleable; 1.5 mm; 14.0 cm	323
133 91 0069	Garrett sonda cévní ohebná; 2,0 mm; 14,0 cm	Garrett vascular dilatator malleable; 2.0 mm; 14.0 cm	323
133 91 0070	Garrett sonda cévní ohebná; 2,5 mm; 14,0 cm	Garrett vascular dilatator malleable; 2.5 mm; 14.0 cm	323
133 91 0071	Garrett sonda cévní ohebná; 3,0 mm; 14,0 cm	Garrett vascular dilatator malleable; 3.0 mm; 14.0 cm	323
133 91 0072	Garrett sonda cévní ohebná; 3,5 mm; 14,0 cm	Garrett vascular dilatator malleable; 3.5 mm; 14.0 cm	323
133 91 0073	Garrett sonda cévní ohebná; 4,0 mm; 14,0 cm	Garrett vascular dilatator malleable; 4.0 mm; 14.0 cm	323
133 91 0074	Garrett sonda cévní ohebná; 4,5 mm; 14,0 cm	Garrett vascular dilatator malleable; 4.5 mm; 14.0 cm	323
133 91 0075	Garrett sonda cévní ohebná; 5,0 mm; 14,0 cm	Garrett vascular dilatator malleable; 5.0 mm; 14.0 cm	323
133 91 0076	Garrett sonda tracheální ohebná; 1,0 mm; 21,0 cm	Garrett tracheal dilatator malleable; 1.0 mm; 21.0 cm	323
133 91 0077	Garrett sonda tracheální ohebná; 1,5 mm; 21,0 cm	Garrett tracheal dilatator malleable; 1.5 mm; 21.0 cm	323
133 91 0078	Garrett sonda tracheální ohebná; 2,0 mm; 21,0 cm	Garrett tracheal dilatator malleable; 2.0 mm; 21.0 cm	323
133 91 0079	Garrett sonda cévní ohebná; 2,5 mm; 21,0 cm	Garrett vascular dilatator malleable; 2.5 mm; 21.0 cm	323
133 91 0080	Garrett sonda cévní ohebná; 3,0 mm; 21,0 cm	Garrett vascular dilatator malleable; 3.0 mm; 21.0 cm	323

číslo – number	název	item	strana – page
133 91 0081	Garrett sonda cévní ohebná; 3,5 mm; 21,0 cm	Garrett vascular dilatator malleable; 3.5 mm; 21.0 cm	323
133 91 0082	Garrett sonda cévní ohebná; 4,0 mm; 21,0 cm	Garrett vascular dilatator malleable; 4.0 mm; 21.0 cm	323
133 91 0083	Garrett sonda cévní ohebná; 4,5 mm; 21,0 cm	Garrett vascular dilatator malleable; 4.5 mm; 21.0 cm	323
133 91 0084	Garrett sonda cévní ohebná; 5,0 mm; 21,0 cm	Garrett vascular dilatator malleable; 5.0 mm; 21.0 cm	323
133 91 0150	Saunders nástroj pro přenos I.U.D.	Saunders instrument for removal I.U.D.	492
133 91 0151	Sims sonda děložní neohbná; 32,0 cm	Sims uterine sound rigid; 32.0 cm	491
133 91 0152	Sims sonda děložní ohebná; 32,0 cm	Sims uterine sound malleable; 32.0 cm	491
133 91 0153	Sims-Special sonda děložní; 32,0 cm	Sims-Special uterine sound; 32.0 cm	491
133 91 0154	Sims Swed. model sonda děložní; 26,0 cm	Sims Swed. model uterine sound; 26.0 cm	491
133 91 0155	Martin sonda děložní; 30,0 cm	Martin uterine sound; 30.0 cm	491
133 91 0156	Valleix sonda děložní; 25,0 cm	Valleix uterine sound; 25.0 cm	491
133 91 0170	Lucae pátradlo háčkové fig.1; 14,0 cm	Lucae hooklet fig.1; 14.0 cm	407
133 91 0171	Lucae pátradlo háčkové fig.2; 14,0 cm	Lucae hooklet fig.2; 14.0 cm	407
133 91 0172	Lucae pátradlo háčkové fig.3; 14,0 cm	Lucae hooklet fig.3; 14.0 cm	407
133 91 0173	Fisch disektor fig.1; 16,0 cm	Fisch dissector fig.1; 16.0 cm	407
133 91 0174	Fisch disektor fig.2; 16,0 cm	Fisch dissector fig.2; 16.0 cm	407
133 91 0175	Fisch disektor fig.3; 16,0 cm	Fisch dissector fig.3; 16.0 cm	407
133 91 0176	Fisch disektor fig.4; 16,0 cm	Fisch dissector fig.4; 16.0 cm	407
134 91 0141	Jehla zaváděcí; 8 Ch	Guide needle; 8 Ch	329
134 91 0142	Jehla zaváděcí; 10 Ch	Guide needle; 10 Ch	329
134 91 0143	Jehla zaváděcí; 12 Ch	Guide needle; 12 Ch	329
134 91 0144	Jehla zaváděcí; 14 Ch	Guide needle; 14 Ch	329
134 91 0145	Jehla zaváděcí; 16 Ch	Guide needle; 16 Ch	329
134 91 0146	Jehla zaváděcí; 18 Ch	Guide needle; 18 Ch	329
134 91 0147	Jehla zaváděcí; 8 Ch	Guide needle; 8 Ch	329
134 91 0148	Jehla zaváděcí; 10 Ch	Guide needle; 10 Ch	329
134 91 0149	Jehla zaváděcí; 12 Ch	Guide needle; 12 Ch	329
134 91 0150	Jehla zaváděcí; 14 Ch	Guide needle; 14 Ch	329
134 91 0151	Jehla zaváděcí; 16 Ch	Guide needle; 16 Ch	329
134 91 0152	Jehla zaváděcí; 18 Ch	Guide needle; 18 Ch	329
135 22 0010	Dilatátor urologický krátký rovný; 8 Ch; 17,0 cm	Urological dilator short straight; 8 Ch; 17.0 cm	339
135 22 0020	Dilatátor urologický krátký rovný; 9 Ch; 17,0 cm	Urological dilator short straight; 9 Ch; 17.0 cm	339
135 22 0030	Dilatátor urologický krátký rovný; 10 Ch; 17,0 cm	Urological dilator short straight; 10 Ch; 17.0 cm	339
135 22 0340	Dilatátor urologický dlouhý zahnutý; 9 Ch; 27,0 cm	Urological dilator long curved; 9 Ch; 27.0 cm	339
135 22 0350	Dilatátor urologický dlouhý zahnutý; 10 Ch; 27,0 cm	Urological dilator long curved; 10 Ch; 27.0 cm	339
135 22 0360	Dilatátor urologický dlouhý zahnutý; 11 Ch; 27,0 cm	Urological dilator long curved; 11 Ch; 27.0 cm	339
135 22 0370	Dilatátor urologický dlouhý zahnutý; 12 Ch; 27,0 cm	Urological dilator long curved; 12 Ch; 27.0 cm	339
135 34 0010	Trousseau rozvěrač trachey; 13,5 cm	Trousseau retractor; 13.5 cm	398
135 91 0001	Hegar dilatátor hrdla děložního tupý; 1,0 mm; 18,5 cm	Hegar uterine dilator; 1.0 mm; 18.5 cm	493
135 91 0002	Hegar dilatátor hrdla děložního tupý; 1,5 mm; 18,5 cm	Hegar uterine dilator; 1.5 mm; 18.5 cm	493
135 91 0003	Hegar dilatátor hrdla děložního tupý; 2,0 mm; 18,5 cm	Hegar uterine dilator; 2.0 mm; 18.5 cm	493
135 91 0004	Hegar dilatátor hrdla děložního tupý; 2,5 mm; 18,5 cm	Hegar uterine dilator; 2.5 mm; 18.5 cm	493
135 91 0005	Hegar dilatátor hrdla děložního tupý; 3,0 mm; 18,5 cm	Hegar uterine dilator; 3.0 mm; 18.5 cm	493
135 91 0006	Hegar dilatátor hrdla děložního tupý; 3,5 mm; 18,5 cm	Hegar uterine dilator; 3.5 mm; 18.5 cm	493
135 91 0007	Hegar dilatátor hrdla děložního tupý; 4,0 mm; 18,5 cm	Hegar uterine dilator; 4.0 mm; 18.5 cm	493
135 91 0008	Hegar dilatátor hrdla děložního tupý; 4,5 mm; 18,5 cm	Hegar uterine dilator; 4.5 mm; 18.5 cm	493
135 91 0009	Hegar dilatátor hrdla děložního tupý; 5,0 mm; 18,5 cm	Hegar uterine dilator; 5.0 mm; 18.5 cm	493
135 91 0010	Hegar dilatátor hrdla děložního tupý; 5,5 mm; 18,5 cm	Hegar uterine dilator; 5.5 mm; 18.5 cm	493
135 91 0011	Hegar dilatátor hrdla děložního tupý; 6,0 mm; 18,5 cm	Hegar uterine dilator; 6.0 mm; 18.5 cm	493
135 91 0012	Hegar dilatátor hrdla děložního tupý; 6,5 mm; 18,5 cm	Hegar uterine dilator; 6.5 mm; 18.5 cm	493
135 91 0013	Hegar dilatátor hrdla děložního tupý; 7,0 mm; 18,5 cm	Hegar uterine dilator; 7.0 mm; 18.5 cm	493
135 91 0014	Hegar dilatátor hrdla děložního tupý; 7,5 mm; 18,5 cm	Hegar uterine dilator; 7.5 mm; 18.5 cm	493
135 91 0015	Hegar dilatátor hrdla děložního tupý; 8,0 mm; 18,5 cm	Hegar uterine dilator; 8.0 mm; 18.5 cm	493
135 91 0016	Hegar dilatátor hrdla děložního tupý; 8,5 mm; 18,5 cm	Hegar uterine dilator; 8.5 mm; 18.5 cm	493
135 91 0017	Hegar dilatátor hrdla děložního tupý; 9,0 mm; 18,5 cm	Hegar uterine dilator; 9.0 mm; 18.5 cm	493
135 91 0018	Hegar dilatátor hrdla děložního tupý; 9,5 mm; 18,5 cm	Hegar uterine dilator; 9.5 mm; 18.5 cm	493
135 91 0019	Hegar dilatátor hrdla děložního tupý; 10,0 mm; 18,5 cm	Hegar uterine dilator; 10.0 mm; 18.5 cm	493
135 91 0020	Hegar dilatátor hrdla děložního tupý; 10,5 mm; 18,5 cm	Hegar uterine dilator; 10.5 mm; 18.5 cm	493
135 91 0021	Hegar dilatátor hrdla děložního tupý; 11,0 mm; 18,5 cm	Hegar uterine dilator; 11.0 mm; 18.5 cm	493
135 91 0022	Hegar dilatátor hrdla děložního tupý; 11,5 mm; 18,5 cm	Hegar uterine dilator; 11.5 mm; 18.5 cm	493
135 91 0023	Hegar dilatátor hrdla děložního tupý; 12,0 mm; 18,5 cm	Hegar uterine dilator; 12.0 mm; 18.5 cm	493
135 91 0024	Hegar dilatátor hrdla děložního tupý; 12,5 mm; 18,5 cm	Hegar uterine dilator; 12.5 mm; 18.5 cm	493
135 91 0025	Hegar dilatátor hrdla děložního tupý; 13,0 mm; 18,5 cm	Hegar uterine dilator; 13.0 mm; 18.5 cm	493
135 91 0026	Hegar dilatátor hrdla děložního tupý; 13,5 mm; 18,5 cm	Hegar uterine dilator; 13.5 mm; 18.5 cm	493
135 91 0027	Hegar dilatátor hrdla děložního tupý; 14,0 mm; 18,5 cm	Hegar uterine dilator; 14.0 mm; 18.5 cm	493
135 91 0028	Hegar dilatátor hrdla děložního tupý; 14,5 mm; 18,5 cm	Hegar uterine dilator; 14.5 mm; 18.5 cm	493
135 91 0029	Hegar dilatátor hrdla děložního tupý; 15,0 mm; 18,5 cm	Hegar uterine dilator; 15.0 mm; 18.5 cm	493
135 91 0030	Hegar dilatátor hrdla děložního tupý; 15,5 mm; 18,5 cm	Hegar uterine dilator; 15.5 mm; 18.5 cm	493
135 91 0031	Hegar dilatátor hrdla děložního tupý; 16,0 mm; 18,5 cm	Hegar uterine dilator; 16.0 mm; 18.5 cm	493
135 91 0032	Hegar dilatátor hrdla děložního tupý; 16,5 mm; 18,5 cm	Hegar uterine dilator; 16.5 mm; 18.5 cm	493
135 91 0033	Hegar dilatátor hrdla děložního tupý; 17,0 mm; 18,5 cm	Hegar uterine dilator; 17.0 mm; 18.5 cm	493
135 91 0034	Hegar dilatátor hrdla děložního tupý; 17,5 mm; 18,5 cm	Hegar uterine dilator; 17.5 mm; 18.5 cm	493
135 91 0035	Hegar dilatátor hrdla děložního tupý; 18,0 mm; 18,5 cm	Hegar uterine dilator; 18.0 mm; 18.5 cm	493
135 91 0036	Hegar dilatátor hrdla děložního tupý; 18,5 mm; 18,5 cm	Hegar uterine dilator; 18.5 mm; 18.5 cm	493
135 91 0037	Hegar dilatátor hrdla děložního tupý; 19,0 mm; 18,5 cm	Hegar uterine dilator; 19.0 mm; 18.5 cm	493
135 91 0038	Hegar dilatátor hrdla děložního tupý; 19,5 mm; 18,5 cm	Hegar uterine dilator; 19.5 mm; 18.5 cm	493
135 91 0039	Hegar dilatátor hrdla děložního tupý; 20,0 mm; 18,5 cm	Hegar uterine dilator; 20.0 mm; 18.5 cm	493
135 91 0040	Hegar dilatátor hrdla děložního tupý; 21,0 mm; 18,5 cm	Hegar uterine dilator; 21.0 mm; 18.5 cm	493
135 91 0041	Hegar dilatátor hrdla děložního tupý; 22,0 mm; 18,5 cm	Hegar uterine dilator; 22.0 mm; 18.5 cm	493
135 91 0042	Hegar dilatátor hrdla děložního tupý; 23,0 mm; 18,5 cm	Hegar uterine dilator; 23.0 mm; 18.5 cm	493
135 91 0043	Hegar dilatátor hrdla děložního tupý; 24,0 mm; 18,5 cm	Hegar uterine dilator; 24.0 mm; 18.5 cm	493
135 91 0044	Hegar dilatátor hrdla děložního tupý; 25,0 mm; 18,5 cm	Hegar uterine dilator; 25.0 mm; 18.5 cm	493
135 91 0045	Hegar dilatátor hrdla děložního tupý; 26,0 mm; 18,5 cm	Hegar uterine dilator; 26.0 mm; 18.5 cm	493
135 91 0046	Hegar dilatátor hrdla děložního tupý; 27,0 mm; 18,5 cm	Hegar uterine dilator; 27.0 mm; 18.5 cm	493



číslo – number	název	item	strana – page
135 91 0047	Hegar dilatátor hrdla děložního tupý; 28,0 mm; 18,5 cm	Hegar uterine dilator; 28.0 mm; 18.5 cm	493
135 91 0048	Hegar dilatátor hrdla děložního tupý; 29,0 mm; 18,5 cm	Hegar uterine dilator; 29.0 mm; 18.5 cm	493
135 91 0049	Hegar dilatátor hrdla děložního tupý; 30,0 mm; 18,5 cm	Hegar uterine dilator; 30.0 mm; 18.5 cm	493
136 17 0120	Pouzdro vodičí; 5,0/4,5 mm; 9,3 cm	Guide sleeve; 5.0/4.5 mm; 9.3 cm	348
136 17 0130	Zavaděč pouzdra vodičího; 19,9 cm	Guide for sleeve; 19.9 cm	348
136 17 0140	Háček; 4,3x2,5 mm; 21,0 cm	Hook; 4.3x2.5 mm; 21.0 cm	348
136 17 0150	Nůž trojúhelníkový; 4,3x1,5 mm; 21,0 cm	Knife; 4.3x1.5 mm; 21.0 cm	348
136 17 0160	Nůž háčkový; 4,3x1,5 mm; 21,0 cm	Knife; 4.3x1.5 mm; 21.0 cm	348
136 27 0310	Extraktor kovový; 26,5 cm	Extractor; 26.5 cm	495
136 39 0010	Toulec na pinzety; 9,0 cm	Quiver for tweezers; 9.0 cm	350
136 39 0020	Toulec na podávkové kleště; 20,0 cm	Quiver for forceps; 20.0 cm	350
136 39 0050	Toulec na pinzety s podstavcem; 11,0 cm	Tweezer quiver with stand; 11.0 cm	350
136 39 0060	Toulec na kleště s podstavcem; 20,0 cm	Forceps quiver with stand; 20.0 cm	350
136 39 0070	Toulec na pinzety s podstavcem; 9,0 cm	Tweezer quiver with stand; 9.0 cm	350
136 39 0140	Krabička sterilizační; nerez; 200x100x30 mm	Sterilization box; 200x100x30 mm	354
136 39 0150	Krabička sterilizační; nerez; 170x70x30 mm	Sterilization box; 170x70x30 mm	354
136 39 0160	Krabička sterilizační; nerez; 200x100x40 mm	Sterilization box; 200x100x40 mm	354
136 39 0170	Krabička s rovným víkem/úchopem; nerez; 210x115x45 mm	Box; 210x115x45 mm	354
136 39 0180	Krabička s příhrádkami dvojí víčko; 210x110x25 mm	Box; 210x110x25 mm	354
136 39 0190	Krabička s vypouklým víčkem; 210x115x45 mm	Box; 210x115x45 mm	354
136 39 0200	Krabička na katetry; víčko s úchytem; nerez; 300x80x40 mm	Box; 300x80x40 mm	354
136 39 0211	Krabička kulatá; nerez; 65x15 mm	Box round; 65x15 mm	355; 433; 434; 435
136 39 0212	Krabička kulatá perforovaná; nerez; 62x13 mm	Box round perforated; 62x13 mm	355; 433; 434; 435
136 39 0213	Krabička kulatá; nerez; 40x13 mm	Box round; 40x13 mm	355
136 39 0214	Krabička kulatá; nerez; 80x18 mm	Box round; 80x18 mm	355
136 39 0215	Krabička kulatá; nerez; 90x20 mm	Box round; 90x20 mm	355
136 39 0216	Krabička kulatá; nerez; 100x20 mm	Box round; 100x20 mm	355
136 39 0220	Krabička s poklopem a úchytem; nerez; 350x90x50 mm	Box; 350x90x50 mm	354
136 39 0230	Krabička s poklopem a úchytem; nerez; 230x150x60 mm	Box; 230x150x60 mm	354
136 39 0240	Krabička s poklopem a rovným úchytem; nerez; 300x200x50 mm	Box; 300x200x50 mm	354
136 39 0250	Krabička s poklopem a rovným úchytem; nerez; 200x150x45 mm	Box; 200x150x45 mm	354
136 91 0006	Tyčinka retrakční atraumatická; 1,5 mm; 16,0 cm	Atraumatic retracting rod; 1.5 mm; 16.0 cm	494
136 91 0007	Tyčinka retrakční atraumatická; 1,5 mm; 20,0 cm	Atraumatic retracting rod; 1.5 mm; 20.0 cm	494
136 91 0008	Tyčinka retrakční atraumatická; 1,0 mm; 16,0 cm	Atraumatic retracting rod; 1.0 mm; 16.0 cm	494
136 91 0009	Tyčinka retrakční atraumatická; 1,0 mm; 20,0 cm	Atraumatic retracting rod; 1.0 mm; 20.0 cm	494
136 91 0010	Tyčinka retrakční atraumatická; 2,5 mm; 16,0 cm	Atraumatic retracting rod; 2.5 mm; 16.0 cm	494
136 91 0011	Tyčinka retrakční atraumatická; 2,5 mm; 20,0 cm	Atraumatic retracting rod; 2.5 mm; 20.0 cm	494
136 91 0012	Tyčinka retrakční atraumatická; 2,0 mm; 16,0 cm	Atraumatic retracting rod; 2.0 mm; 16.0 cm	494
136 91 0013	Tyčinka retrakční atraumatická; 2,0 mm; 20,0 cm	Atraumatic retracting rod; 2.0 mm; 20.0 cm	494
136 91 0014	Tyčinka retrakční atraumatická; 3,0 mm; 16,0 cm	Atraumatic retracting rod; 3.0 mm; 16.0 cm	494
136 91 0015	Tyčinka retrakční atraumatická; 3,5 mm; 16,0 cm	Atraumatic retracting rod; 3.5 mm; 16.0 cm	494
136 91 0016	Tyčinka retrakční atraumatická; 3,5 mm; 20,0 cm	Atraumatic retracting rod; 3.5 mm; 20.0 cm	494
136 91 0017	Tyčinka retrakční atraumatická; 3,0 mm; 20,0 cm	Atraumatic retracting rod; 3.0 mm; 20.0 cm	494
136 91 0018	Tyčinka retrakční atraumatická; 4,0 mm; 16,0 cm	Atraumatic retracting rod; 4.0 mm; 16.0 cm	494
136 91 0019	Tyčinka retrakční atraumatická; 4,0 mm; 20,0 cm	Atraumatic retracting rod; 4.0 mm; 20.0 cm	494
136 91 0020	Tyčinka retrakční atraumatická; 4,5 mm; 16,0 cm	Atraumatic retracting rod; 4.5 mm; 16.0 cm	494
136 91 0021	Tyčinka retrakční atraumatická; 4,5 mm; 20,0 cm	Atraumatic retracting rod; 4.5 mm; 20.0 cm	494
136 91 0022	Tyčinka retrakční atraumatická; 5,0 mm; 16,0 cm	Atraumatic retracting rod; 5.0 mm; 16.0 cm	494
136 91 0023	Tyčinka retrakční atraumatická; 5,0 mm; 20,0 cm	Atraumatic retracting rod; 5.0 mm; 20.0 cm	494
136 91 0025	Ramathibodi manipulátor děložní; 27,5 cm	Ramathibodi uterine manipulator; 27.5 cm	495
136 91 0026	Ramathibodi hák; 25,0 cm	Ramathibodi tubual hook; 25.0 cm	495
136 91 0027	Iowa trubička; 14,0 cm	Iowa tube; 14.0 cm	494
136 91 0036	Krabice na nástroje s víkem; 16,5x9,0x3,5 cm	Box for instruments with a lid; 16.5x9.0x3.5 cm	353
136 91 0037	Krabice na nástroje s víkem; 20,0x10,0x5,0 cm	Box for instruments with a lid; 20.0x10.0x5.0 cm	353
136 91 0038	Krabice na nástroje s víkem; 22,0x15,0x5,0 cm	Box for instruments with a lid; 22.0x15.0x5.0 cm	353
136 91 0039	Krabice na nástroje s víkem; 26,0x15,0x5,0 cm	Box for instruments with a lid; 26.0x15.0x5.0 cm	353
136 91 0040	Krabice na nástroje s víkem; 30,5x20,5x5,0 cm	Box for instruments with a lid; 30.5x20.5x5.0 cm	353
136 91 0070	Toulec nerez ocel; 50x100 mm	Quiver stainless steel; 50x100 mm	350
136 91 0071	Toulec nerez ocel; 75x175 mm	Quiver stainless steel; 75x175 mm	350
136 91 0072	Toulec nerez ocel; 30x90 mm	Quiver stainless steel; 30x90 mm	350
136 91 0073	Toulec nerez ocel; 50x130 mm	Quiver stainless steel; 50x130 mm	350
136 91 0074	Toulec nerez ocel; 50x175 mm	Quiver stainless steel; 50x175 mm	350
136 91 0075	Toulec nerez ocel; 75x100 mm	Quiver stainless steel; 75x100 mm	350
136 91 0076	Toulec nerez ocel; 75x130 mm	Quiver stainless steel; 75x130 mm	350
136 91 0077	Miska; 0,05 l; 4,0x1,9 cm	Bowl; 0.05 l; 4.0x1.9 cm	351
136 91 0078	Miska; 0,07 l; 6,1x3,0 cm	Bowl; 0.07 l; 6.1x3.0 cm	351
136 91 0079	Miska; 0,14 l; 8,0x4,0 cm	Bowl; 0.14 l; 8.0x4.0 cm	351
136 91 0080	Miska; 0,35 l; 11,6x5,0 cm	Bowl; 0.35 l; 11.6x5.0 cm	351
136 91 0081	Miska; 0,45 l; 12,8x5,5 cm	Bowl; 0.45 l; 12.8x5.5 cm	351; 432-435
136 91 0082	Miska; 0,70 l; 14,7x6,5 cm	Bowl; 0.70 l; 14.7x6.5 cm	351; 433; 435
136 91 0083	Nálevka; 0,25 l	Funnel; 0.25 l	351
136 91 0084	Nálevka; 0,5 l	Funnel; 0.5 l	351
136 91 0085	Nálevka; 1,0 l	Funnel; 1.0 l	351
136 91 0087	Miska; 17,0 cm	Bowl; 17.0 cm	351
136 91 0088	Miska; 25,0 cm	Bowl; 25.0 cm	351; 432; 434
136 91 0089	Miska; 27,5 cm	Bowl; 27.5 cm	351
136 91 0092	Jehelník; 5,0x2,5x0,45 cm	Needle case; 5.0x2.5x0.45 cm	355
136 91 0093	Jehelník; 6,5x4,2x8,0 cm	Needle case; 6.5x4.2x8.0 cm	355
136 91 0094	Jehelník; 7,5x2,5x0,45 cm	Needle case; 7.5x2.5x0.45 cm	355
136 91 0096	Jehelník; 15,0x9,5x1,3 cm	Needle case; 15.0x9.5x1.3 cm	355
136 91 0097	Tác; 23,0x15,5x3,0 cm	Tray; 23.0x15.5x3.0 cm	352; 432
136 91 0098	Tác; 30,0x17,5x3,0 cm	Tray; 30.0x17.5x3.0 cm	352
136 91 0099	Tác; 30,0x17,5x4,0 cm	Tray; 30.0x17.5x4.0 cm	352
136 91 0100	Tác; 35,0x24,0x3,6 cm	Tray; 35.0x24.0x3.6 cm	352



číslo – number	název	item	strana – page
29-436-006	Ferris-Smith-Kerrison štípek na laminektomii; 23,0 cm; 6 mm; 40° dolu	Ferris-Smith-Kerrison laminect. punch; 23.0 cm; 6 mm; 40° downward cutting	515
304-150-270	De Bakey odsávačka; 28 cm	De Bakey suction tube; 28 cm	336
304-151-300	Magill kanyla aspirační; 3,0 mm; 24,5 cm	Magill aspirating tube; 3.0 mm; 24.5 cm	332
304-151-350	Magill kanyla aspirační; 3,5 mm; 24,5 cm	Magill aspirating tube; 3.5 mm; 24.5 cm	332
304-151-400	Magill kanyla aspirační; 4,0 mm; 24,5 cm	Magill aspirating tube; 4.0 mm; 24.5 cm	332
322-226-070	Ouinke jehla na biopsii; 0,7 mm; 76 mm	Ouinke biopsy needle; 0.7 mm; 76 mm	330
322-226-100	Ouinke jehla na biopsii; 1,0 mm; 76 mm	Ouinke biopsy needle; 1.0 mm; 76 mm	330
322-226-120	Ouinke jehla na biopsii; 1,2 mm; 76 mm	Ouinke biopsy needle; 1.2 mm; 76 mm	330
322-228-070	Ouinke jehla na biopsii; 0,7 mm; 89 mm	Ouinke biopsy needle; 0.7 mm; 89 mm	330
322-228-100	Ouinke jehla na biopsii; 1,0 mm; 89 mm	Ouinke biopsy needle; 1.0 mm; 89 mm	330
322-228-120	Ouinke jehla na biopsii; 1,2 mm; 89 mm	Ouinke biopsy needle; 1.2 mm; 89 mm	330
322-230-070	Ouinke jehla na biopsii; 0,7 mm; 50 mm	Ouinke biopsy needle; 0.7 mm; 50 mm	330
322-232-100	Bier jehla na biopsii; 1,0 mm; 80 mm	Bier biopsy needle; 1.0 mm; 80 mm	330
322-232-120	Bier jehla na biopsii; 1,2 mm; 80 mm	Bier biopsy needle; 1.2 mm; 80 mm	330
322-232-150	Bier jehla na biopsii; 1,5 mm; 80 mm	Bier biopsy needle; 1.5 mm; 80 mm	330
322-232-180	Bier jehla na biopsii; 1,8 mm; 80 mm	Bier biopsy needle; 1.8 mm; 80 mm	330
333-562-170	Kleště úchopné na drát; ploché; 17,0 cm	Flat nose pliers; 17.0 cm	190
337-850-060	Fréza pro ORL nerezová; 0,6 mm; 70 mm	Rosen bur SS; 0.6 mm; 70 mm	429
337-850-070	Fréza pro ORL nerezová; 0,7 mm; 70 mm	Rosen bur SS; 0.7 mm; 70 mm	429
337-850-080	Fréza pro ORL nerezová; 0,8 mm; 70 mm	Rosen bur SS; 0.8 mm; 70 mm	429
337-850-100	Fréza pro ORL nerezová; 1,0 mm; 70 mm	Rosen bur SS; 1.0 mm; 70 mm	429
337-850-140	Fréza pro ORL nerezová; 1,4 mm; 70 mm	Rosen bur SS; 1.4 mm; 70 mm	429
337-850-180	Fréza pro ORL nerezová; 1,8 mm; 70 mm	Rosen bur SS; 1.8 mm; 70 mm	429
337-850-230	Fréza pro ORL nerezová; 2,3 mm; 70 mm	Rosen bur SS; 2.3 mm; 70 mm	429
337-850-270	Fréza pro ORL nerezová; 2,7 mm; 70 mm	Rosen bur SS; 2.7 mm; 70 mm	429
337-850-310	Fréza pro ORL nerezová; 3,1 mm; 70 mm	Rosen bur SS; 3.1 mm; 70 mm	429
337-850-350	Fréza pro ORL nerezová; 3,5 mm; 70 mm	Rosen bur SS; 3.5 mm; 70 mm	429
337-850-400	Fréza pro ORL nerezová; 4,0 mm; 70 mm	Rosen bur SS; 4.0 mm; 70 mm	429
337-850-450	Fréza pro ORL nerezová; 4,5 mm; 70 mm	Rosen bur SS; 4.5 mm; 70 mm	429
337-850-500	Fréza pro ORL nerezová; 5,0 mm; 70 mm	Rosen bur SS; 5.0 mm; 70 mm	429
337-850-600	Fréza pro ORL nerezová; 6,0 mm; 70 mm	Rosen bur SS; 6.0 mm; 70 mm	429
337-850-700	Fréza pro ORL nerezová; 7,0 mm; 70 mm	Rosen bur SS; 7.0 mm; 70 mm	429
337-852-140	Fréza pro ORL nerezová; 1,4 mm; 95 mm	Rosen bur SS; 1.4 mm; 95 mm	429
337-852-180	Fréza pro ORL nerezová; 1,8 mm; 95 mm	Rosen bur SS; 1.8 mm; 95 mm	429
337-852-230	Fréza pro ORL nerezová; 2,3 mm; 95 mm	Rosen bur SS; 2.3 mm; 95 mm	429
337-852-270	Fréza pro ORL nerezová; 2,7 mm; 95 mm	Rosen bur SS; 2.7 mm; 95 mm	429
337-852-310	Fréza pro ORL nerezová; 3,1 mm; 95 mm	Rosen bur SS; 3.1 mm; 95 mm	429
337-852-350	Fréza pro ORL nerezová; 3,5 mm; 95 mm	Rosen bur SS; 3.5 mm; 95 mm	429
337-852-400	Fréza pro ORL nerezová; 4,0 mm; 95 mm	Rosen bur SS; 4.0 mm; 95 mm	429
337-852-450	Fréza pro ORL nerezová; 4,5 mm; 95 mm	Rosen bur SS; 4.5 mm; 95 mm	429
337-852-500	Fréza pro ORL nerezová; 5,0 mm; 95 mm	Rosen bur SS; 5.0 mm; 95 mm	429
337-852-600	Fréza pro ORL nerezová; 6,0 mm; 95 mm	Rosen bur SS; 6.0 mm; 95 mm	429
337-852-700	Fréza pro ORL nerezová; 7,0 mm; 95 mm	Rosen bur SS; 7.0 mm; 95 mm	429
339-176-060	Fréza pro ORL diamantovaná; 0,6 mm; 70 mm	Diamond bur; 0.6 mm; 70 mm	430
339-176-070	Fréza pro ORL diamantovaná; 0,7 mm; 70 mm	Diamond bur; 0.7 mm; 70 mm	430
339-176-080	Fréza pro ORL diamantovaná; 0,8 mm; 70 mm	Diamond bur; 0.8 mm; 70 mm	430
339-176-100	Fréza pro ORL diamantovaná; 1,0 mm; 70 mm	Diamond bur; 1.0 mm; 70 mm	430
339-176-150	Fréza pro ORL diamantovaná; 1,5 mm; 70 mm	Diamond bur; 1.5 mm; 70 mm	430
339-176-180	Fréza pro ORL diamantovaná; 1,8 mm; 70 mm	Diamond bur; 1.8 mm; 70 mm	430
339-176-230	Fréza pro ORL diamantovaná; 2,3 mm; 70 mm	Diamond bur; 2.3 mm; 70 mm	430
339-176-270	Fréza pro ORL diamantovaná; 2,7 mm; 70 mm	Diamond bur; 2.7 mm; 70 mm	430
339-176-300	Fréza pro ORL diamantovaná; 3,1 mm; 70 mm	Diamond bur; 3.1 mm; 70 mm	430
339-176-350	Fréza pro ORL diamantovaná; 3,5 mm; 70 mm	Diamond bur; 3.5 mm; 70 mm	430
339-176-400	Fréza pro ORL diamantovaná; 4,0 mm; 70 mm	Diamond bur; 4.0 mm; 70 mm	430
339-176-450	Fréza pro ORL diamantovaná; 4,5 mm; 70 mm	Diamond bur; 4.5 mm; 70 mm	430
339-176-500	Fréza pro ORL diamantovaná; 5,0 mm; 70 mm	Diamond bur; 5.0 mm; 70 mm	430
339-176-600	Fréza pro ORL diamantovaná; 6,0 mm; 70 mm	Diamond bur; 6.0 mm; 70 mm	430
339-176-700	Fréza pro ORL diamantovaná; 7,0 mm; 70 mm	Diamond bur; 7.0 mm; 70 mm	430
339-178-150	Fréza pro ORL diamantovaná; 1,5 mm; 95 mm	Diamond bur; 1.5 mm; 95 mm	430
339-178-180	Fréza pro ORL diamantovaná; 1,8 mm; 95 mm	Diamond bur; 1.8 mm; 95 mm	430
339-178-230	Fréza pro ORL diamantovaná; 2,3 mm; 95 mm	Diamond bur; 2.3 mm; 95 mm	430
339-178-270	Fréza pro ORL diamantovaná; 2,7 mm; 95 mm	Diamond bur; 2.7 mm; 95 mm	430
339-178-300	Fréza pro ORL diamantovaná; 3,1 mm; 95 mm	Diamond bur; 3.1 mm; 95 mm	430
339-178-350	Fréza pro ORL diamantovaná; 3,5 mm; 95 mm	Diamond bur; 3.5 mm; 95 mm	430
339-178-400	Fréza pro ORL diamantovaná; 4,0 mm; 95 mm	Diamond bur; 4.0 mm; 95 mm	430
339-178-450	Fréza pro ORL diamantovaná; 4,5 mm; 95 mm	Diamond bur; 4.5 mm; 95 mm	430
339-178-500	Fréza pro ORL diamantovaná; 5,0 mm; 95 mm	Diamond bur; 5.0 mm; 95 mm	430
339-178-600	Fréza pro ORL diamantovaná; 6,0 mm; 95 mm	Diamond bur; 6.0 mm; 95 mm	430
339-178-700	Fréza pro ORL diamantovaná; 7,0 mm; 95 mm	Diamond bur; 7.0 mm; 95 mm	430
340-286-140	Adson kanyla aspirační; 9 Charr./Fr.; 3 mm; 14,0 cm	Adson aspirating tube; 9 Charr./Fr.; 3 mm; 14.0 cm	334
340-286-210	Adson kanyla aspirační; 12 Charr./Fr.; 4 mm; 21,0 cm	Adson aspirating tube; 12 Charr./Fr.; 4 mm; 21.0 cm	334
340-286-211	Adson kanyla aspirační; 15 Charr./Fr.; 5 mm; 21,0 cm	Adson aspirating tube; 15 Charr./Fr.; 5 mm; 21.0 cm	334
340-291-070	Frazier kanyla aspirační 30°; 7 Charr./Fr.; 19,0 cm	Frazier aspirating cannula 30°; 7 Charr./Fr.; 19.0 cm	334
340-291-090	Frazier kanyla aspirační 30°; 9 Charr./Fr.; 19,0 cm	Frazier aspirating cannula 30°; 9 Charr./Fr.; 19.0 cm	334
340-291-150	Frazier kanyla aspirační 30°; 15 Charr./Fr.; 19,0 cm	Frazier aspirating cannula 30°; 15 Charr./Fr.; 19.0 cm	334
340-500-010	Ferris-Smith-Kerrison štípek na laminektomii; 20,0 cm; 1 mm; 90° dolu	Ferris-Smith-Kerrison laminect. punch; 20.0 cm; 1 mm; 90° downward cutting	514
340-500-020	Ferris-Smith-Kerrison štípek na laminektomii; 20,0 cm; 2 mm; 90° dolu	Ferris-Smith-Kerrison laminect. punch; 20.0 cm; 2 mm; 90° downward cutting	514
340-500-030	Ferris-Smith-Kerrison štípek na laminektomii; 20,0 cm; 3 mm; 90° dolu	Ferris-Smith-Kerrison laminect. punch; 20.0 cm; 3 mm; 90° downward cutting	514
340-500-040	Ferris-Smith-Kerrison štípek na laminektomii; 20,0 cm; 4 mm; 90° dolu	Ferris-Smith-Kerrison laminect. punch; 20.0 cm; 4 mm; 90° downward cutting	514
340-500-050	Ferris-Smith-Kerrison štípek na laminektomii; 20,0 cm; 5 mm; 90° dolu	Ferris-Smith-Kerrison laminect. punch; 20.0 cm; 5 mm; 90° downward cutting	514
340-500-060	Ferris-Smith-Kerrison štípek na laminektomii; 20,0 cm; 6 mm; 90° dolu	Ferris-Smith-Kerrison laminect. punch; 20.0 cm; 6 mm; 90° downward cutting	514
340-502-010	Ferris-Smith-Kerrison štípek na laminektomii; 20,0 cm; 1 mm; 90° nahoru	Ferris-Smith-Kerrison laminect. punch; 20.0 cm; 1 mm; 90° upward cutting	514
340-502-020	Ferris-Smith-Kerrison štípek na laminektomii; 20,0 cm; 2 mm; 90° nahoru	Ferris-Smith-Kerrison laminect. punch; 20.0 cm; 2 mm; 90° upward cutting	514
340-502-030	Ferris-Smith-Kerrison štípek na laminektomii; 20,0 cm; 3 mm; 90° nahoru	Ferris-Smith-Kerrison laminect. punch; 20.0 cm; 3 mm; 90° upward cutting	514



číslo – number	název	item	strana – page
340-502-040	Ferris-Smith-Kerrison štípák na laminektomii; 20,0 cm; 4 mm; 90° nahoru	Ferris-Smith-Kerrison laminect. punch; 20.0 cm; 4 mm; 90° upward cutting	514
340-502-050	Ferris-Smith-Kerrison štípák na laminektomii; 20,0 cm; 5 mm; 90° nahoru	Ferris-Smith-Kerrison laminect. punch; 20.0 cm; 5 mm; 90° upward cutting	514
340-502-060	Ferris-Smith-Kerrison štípák na laminektomii; 20,0 cm; 6 mm; 90° nahoru	Ferris-Smith-Kerrison laminect. punch; 20.0 cm; 6 mm; 90° upward cutting	514
340-503-010	Ferris-Smith-Kerrison štípák na laminektomii; 20,0 cm; 1 mm; 40° nahoru	Ferris-Smith-Kerrison laminect. punch; 20.0 cm; 1 mm; 40° upward cutting	515
340-503-020	Ferris-Smith-Kerrison štípák na laminektomii; 20,0 cm; 2 mm; 40° nahoru	Ferris-Smith-Kerrison laminect. punch; 20.0 cm; 2 mm; 40° upward cutting	515
340-503-030	Ferris-Smith-Kerrison štípák na laminektomii; 20,0 cm; 3 mm; 40° nahoru	Ferris-Smith-Kerrison laminect. punch; 20.0 cm; 3 mm; 40° upward cutting	515
340-503-040	Ferris-Smith-Kerrison štípák na laminektomii; 20,0 cm; 4 mm; 40° nahoru	Ferris-Smith-Kerrison laminect. punch; 20.0 cm; 4 mm; 40° upward cutting	515
340-503-050	Ferris-Smith-Kerrison štípák na laminektomii; 20,0 cm; 5 mm; 40° nahoru	Ferris-Smith-Kerrison laminect. punch; 20.0 cm; 5 mm; 40° upward cutting	515
340-503-060	Ferris-Smith-Kerrison štípák na laminektomii; 20,0 cm; 6 mm; 40° nahoru	Ferris-Smith-Kerrison laminect. punch; 20.0 cm; 6 mm; 40° upward cutting	515
340-506-010	Ferris-Smith-Kerrison štípák na laminektomii; 18,0 cm; 1 mm; 90° nahoru	Ferris-Smith-Kerrison laminect. punch; 18.0 cm; 1 mm; 90° upward cutting	514
340-506-040	Ferris-Smith-Kerrison štípák na laminektomii; 18,0 cm; 4 mm; 90° nahoru	Ferris-Smith-Kerrison laminect. punch; 18.0 cm; 4 mm; 90° upward cutting	514
340-506-060	Ferris-Smith-Kerrison štípák na laminektomii; 18,0 cm; 6 mm; 90° nahoru	Ferris-Smith-Kerrison laminect. punch; 18.0 cm; 6 mm; 90° upward cutting	514
340-507-010	Ferris-Smith-Kerrison štípák na laminektomii; 18,0 cm; 1 mm; 90° dolu	Ferris-Smith-Kerrison laminect. punch; 18.0 cm; 1 mm; 90° downward cutting	514
340-507-040	Ferris-Smith-Kerrison štípák na laminektomii; 18,0 cm; 4 mm; 90° dolu	Ferris-Smith-Kerrison laminect. punch; 18.0 cm; 4 mm; 90° downward cutting	514
340-507-060	Ferris-Smith-Kerrison štípák na laminektomii; 18,0 cm; 6 mm; 90° dolu	Ferris-Smith-Kerrison laminect. punch; 18.0 cm; 6 mm; 90° downward cutting	514
340-508-010	Ferris-Smith-Kerrison štípák na laminektomii; 18,0 cm; 1 mm; 40° nahoru	Ferris-Smith-Kerrison laminect. punch; 18.0 cm; 1 mm; 40° upward cutting	515
340-508-040	Ferris-Smith-Kerrison štípák na laminektomii; 18,0 cm; 4 mm; 40° nahoru	Ferris-Smith-Kerrison laminect. punch; 18.0 cm; 4 mm; 40° upward cutting	515
340-508-060	Ferris-Smith-Kerrison štípák na laminektomii; 18,0 cm; 6 mm; 40° nahoru	Ferris-Smith-Kerrison laminect. punch; 18.0 cm; 6 mm; 40° upward cutting	515
340-509-010	Ferris-Smith-Kerrison štípák na laminektomii; 18,0 cm; 1 mm; 40° dolu	Ferris-Smith-Kerrison laminect. punch; 18.0 cm; 1 mm; 40° downward cutting	515
340-509-020	Ferris-Smith-Kerrison štípák na laminektomii; 18,0 cm; 2 mm; 40° dolu	Ferris-Smith-Kerrison laminect. punch; 18.0 cm; 2 mm; 40° downward cutting	515
340-509-030	Ferris-Smith-Kerrison štípák na laminektomii; 18,0 cm; 3 mm; 40° dolu	Ferris-Smith-Kerrison laminect. punch; 18.0 cm; 3 mm; 40° downward cutting	515
340-509-040	Ferris-Smith-Kerrison štípák na laminektomii; 18,0 cm; 4 mm; 40° dolu	Ferris-Smith-Kerrison laminect. punch; 18.0 cm; 4 mm; 40° downward cutting	515
340-509-050	Ferris-Smith-Kerrison štípák na laminektomii; 18,0 cm; 5 mm; 40° dolu	Ferris-Smith-Kerrison laminect. punch; 18.0 cm; 5 mm; 40° downward cutting	515
340-509-060	Ferris-Smith-Kerrison štípák na laminektomii; 18,0 cm; 6 mm; 40° dolu	Ferris-Smith-Kerrison laminect. punch; 18.0 cm; 6 mm; 40° downward cutting	515
340-511-010	Ferris-Smith-Kerrison štípák na lamin. tenká patka; 18,0 cm; 1 mm; 40° nahoru	Ferris-Smith-Kerrison lamin. punch thin footplate; 18.0 cm; 1 mm; 40° up. cut.	515
340-511-020	Ferris-Smith-Kerrison štípák na lamin. tenká patka; 18,0 cm; 2 mm; 40° nahoru	Ferris-Smith-Kerrison lamin. punch thin footplate; 18.0 cm; 2 mm; 40° up. cut.	515
340-511-030	Ferris-Smith-Kerrison štípák na lamin. tenká patka; 18,0 cm; 3 mm; 40° nahoru	Ferris-Smith-Kerrison lamin. punch thin footplate; 18.0 cm; 3 mm; 40° up. cut.	515
340-513-010	Ferris-Smith-Kerrison štípák na lamin. tenká patka; 18,0 cm; 1 mm; 40° dolu	Ferris-Smith-Kerrison lamin. punch thin footplate; 18.0 cm; 1 mm; 40° down. cut.	515
340-513-020	Ferris-Smith-Kerrison štípák na lamin. tenká patka; 18,0 cm; 2 mm; 40° dolu	Ferris-Smith-Kerrison lamin. punch thin footplate; 18.0 cm; 2 mm; 40° down. cut.	515
340-513-030	Ferris-Smith-Kerrison štípák na lamin. tenká patka; 18,0 cm; 3 mm; 40° dolu	Ferris-Smith-Kerrison lamin. punch thin footplate; 18.0 cm; 3 mm; 40° dow. cut.	515
340-519-010	Ferris-Smith-Kerrison štípák na laminektomii; 20,0 cm; 1 mm; 40° dolu	Ferris-Smith-Kerrison laminect. punch; 20.0 cm; 1 mm; 40° downward cutting	515
340-519-020	Ferris-Smith-Kerrison štípák na laminektomii; 20,0 cm; 2 mm; 40° dolu	Ferris-Smith-Kerrison laminect. punch; 20.0 cm; 2 mm; 40° downward cutting	515
340-519-030	Ferris-Smith-Kerrison štípák na laminektomii; 20,0 cm; 3 mm; 40° dolu	Ferris-Smith-Kerrison laminect. punch; 20.0 cm; 3 mm; 40° downward cutting	515
340-519-040	Ferris-Smith-Kerrison štípák na laminektomii; 20,0 cm; 4 mm; 40° dolu	Ferris-Smith-Kerrison laminect. punch; 20.0 cm; 4 mm; 40° downward cutting	515
340-519-050	Ferris-Smith-Kerrison štípák na laminektomii; 20,0 cm; 5 mm; 40° dolu	Ferris-Smith-Kerrison laminect. punch; 20.0 cm; 5 mm; 40° downward cutting	515
340-519-060	Ferris-Smith-Kerrison štípák na laminektomii; 20,0 cm; 6 mm; 40° dolu	Ferris-Smith-Kerrison laminect. punch; 20.0 cm; 6 mm; 40° downward cutting	515
344-090-160	Iowa odsávačka; 0,7 mm; 16,0 cm	Iowa suction tube; 0.7 mm; 16.0 cm	332
344-095-000	Zöllner komplet s kanylou; 0,7 mm	Zöllner complete with 1 slip-on cannula; 0.7 mm	332
344-097-030	Baron odsávačka 1 mm; 3 Charr./Fr.; 75 mm	Baron suction tube 1 mm; 3 Charr./Fr.; 75 mm	333
344-097-030/L	Baron odsávačka 1 mm; 3 Charr./Fr.; 100 mm	Baron suction tube 1 mm; 3 Charr./Fr.; 100 mm	333
344-097-050	Baron odsávačka 1,7 mm; 5 Charr./Fr.; 75 mm	Baron suction tube 1.7 mm; 5 Charr./Fr.; 75 mm	333
344-097-050/L	Baron odsávačka 1,7 mm; 5 Charr./Fr.; 100 mm	Baron suction tube 1.7 mm; 5 Charr./Fr.; 100 mm	333
344-097-070	Baron odsávačka 2 mm; 7 Charr./Fr.; 75 mm	Baron suction tube 2 mm; 7 Charr./Fr.; 75 mm	333
344-097-070/L	Baron odsávačka 2 mm; 7 Charr./Fr.; 100 mm	Baron suction tube 2 mm; 7 Charr./Fr.; 100 mm	333
344-099-010	House odsávačka vyplachovací fig.1	House suction irrigation tube fig.1	333
344-099-020	House odsávačka vyplachovací fig.2	House suction irrigation tube fig.2	333
344-099-030	House odsávačka vyplachovací fig.3	House suction irrigation tube fig.3	333
344-099-040	House odsávačka vyplachovací fig.4	House suction irrigation tube fig.4	333
344-099-050	House odsávačka vyplachovací fig.5	House suction irrigation tube fig.5	333
344-099-060	House odsávačka vyplachovací fig.6	House suction irrigation tube fig.6	333
344-099-070	House odsávačka vyplachovací fig.7	House suction irrigation tube fig.7	333
350-288-000	Jehla na mandle přímá; 0,8 mm	Tonsil needle straight; 0.8 mm	331
350-289-000	Jehla na nosní přepážku bajonetová; 0,8 mm	Septum needle bayonet; 0.8 mm	331
350-289-450	Jehla na nosní přepážku lomená 45°; 0,8 mm	Septum needle angled on flat 45°; 0.8 mm	331
350-289-900	Jehla na mandle zahnutá 90°; 0,8 mm	Tonsil needle curved 90°; 0.8 mm	331
366-196-000	Guyon set dilatátorů v krabičce	Guyon dilator set in case complet	341
366-201-080	Guyon dilatátor; 8 Charr./Fr.	Guyon dilating bougie 8 Charr./Fr.	341
366-201-100	Guyon dilatátor; 10 Charr./Fr.	Guyon dilating bougie 10 Charr./Fr.	341
366-201-110	Guyon dilatátor; 11 Charr./Fr.	Guyon dilating bougie 11 Charr./Fr.	341
366-201-120	Guyon dilatátor; 12 Charr./Fr.	Guyon dilating bougie 12 Charr./Fr.	341
366-201-130	Guyon dilatátor; 13 Charr./Fr.	Guyon dilating bougie 13 Charr./Fr.	341
366-201-140	Guyon dilatátor; 14 Charr./Fr.	Guyon dilating bougie 14 Charr./Fr.	341
366-201-150	Guyon dilatátor; 15 Charr./Fr.	Guyon dilating bougie 15 Charr./Fr.	341
366-201-160	Guyon dilatátor; 16 Charr./Fr.	Guyon dilating bougie 16 Charr./Fr.	341
366-201-170	Guyon dilatátor; 17 Charr./Fr.	Guyon dilating bougie 17 Charr./Fr.	341
366-201-180	Guyon dilatátor; 18 Charr./Fr.	Guyon dilating bougie 18 Charr./Fr.	341
366-201-190	Guyon dilatátor; 19 Charr./Fr.	Guyon dilating bougie 19 Charr./Fr.	341
366-201-200	Guyon dilatátor; 20 Charr./Fr.	Guyon dilating bougie 20 Charr./Fr.	341
366-201-210	Guyon dilatátor; 21 Charr./Fr.	Guyon dilating bougie 21 Charr./Fr.	341
366-201-220	Guyon dilatátor; 22 Charr./Fr.	Guyon dilating bougie 22 Charr./Fr.	341
366-201-230	Guyon dilatátor; 23 Charr./Fr.	Guyon dilating bougie 23 Charr./Fr.	341
366-201-240	Guyon dilatátor; 24 Charr./Fr.	Guyon dilating bougie 24 Charr./Fr.	341
366-201-250	Guyon dilatátor; 25 Charr./Fr.	Guyon dilating bougie 25 Charr./Fr.	341
366-201-260	Guyon dilatátor; 26 Charr./Fr.	Guyon dilating bougie 26 Charr./Fr.	341
366-201-270	Guyon dilatátor; 27 Charr./Fr.	Guyon dilating bougie 27 Charr./Fr.	341
366-201-280	Guyon dilatátor; 28 Charr./Fr.	Guyon dilating bougie 28 Charr./Fr.	341
366-201-290	Guyon dilatátor; 29 Charr./Fr.	Guyon dilating bougie 29 Charr./Fr.	341
366-201-300	Guyon dilatátor; 30 Charr./Fr.	Guyon dilating bougie 30 Charr./Fr.	341
366-201-310	Guyon dilatátor; 31 Charr./Fr.	Guyon dilating bougie 31 Charr./Fr.	341
366-201-320	Guyon dilatátor; 32 Charr./Fr.	Guyon dilating bougie 32 Charr./Fr.	341
366-201-330	Guyon dilatátor; 33 Charr./Fr.	Guyon dilating bougie 33 Charr./Fr.	341
366-201-340	Guyon dilatátor; 34 Charr./Fr.	Guyon dilating bougie 34 Charr./Fr.	341
366-201-350	Guyon dilatátor; 35 Charr./Fr.	Guyon dilating bougie 35 Charr./Fr.	341
366-201-360	Guyon dilatátor; 36 Charr./Fr.	Guyon dilating bougie 36 Charr./Fr.	341

číslo – number	název	item	strana – page
<b>366-201-370</b>	Guyon dilatátor; 37 Charr./Fr.	Guyon dilating bougie 37 Charr./Fr.	341
<b>366-201-380</b>	Guyon dilatátor; 38 Charr./Fr.	Guyon dilating bougie 38 Charr./Fr.	341
<b>366-201-390</b>	Guyon dilatátor; 39 Charr./Fr.	Guyon dilating bougie 39 Charr./Fr.	341
<b>366-201-400</b>	Guyon dilatátor; 40 Charr./Fr.	Guyon dilating bougie 40 Charr./Fr.	341
<b>370-588-010</b>	Novak sací kyreta na biopsii; 1 mm; 23,0 cm	Novak aspiration curette; 1 mm; 23 cm	489
<b>370-588-020</b>	Novak sací kyreta na biopsii; 2 mm; 23,0 cm	Novak aspiration curette; 2 mm; 23 cm	489
<b>370-588-030</b>	Novak sací kyreta na biopsii; 3 mm; 23,0 cm	Novak aspiration curette; 3 mm; 23 cm	489
<b>370-588-040</b>	Novak sací kyreta na biopsii; 4 mm; 23,0 cm	Novak aspiration curette; 4 mm; 23 cm	489
<b>38-420-001</b>	Menghini jehla na biopsii; 1,0 mm; 35 mm	Menghini biopsy needle; 1.0 mm; 35 mm	330
<b>38-420-002</b>	Menghini jehla na biopsii; 1,0 mm; 70 mm	Menghini biopsy needle; 1.0 mm; 70 mm	330
<b>38-420-003</b>	Menghini jehla na biopsii; 1,2 mm; 70 mm	Menghini biopsy needle; 1.2 mm; 70 mm	330
<b>38-420-004</b>	Menghini jehla na biopsii; 1,2 mm; 100 mm	Menghini biopsy needle; 1.2 mm; 100 mm	330
<b>38-420-005</b>	Menghini jehla na biopsii; 1,4 mm; 70 mm	Menghini biopsy needle; 1.4 mm; 70 mm	330
<b>38-420-006</b>	Menghini jehla na biopsii; 1,4 mm; 100 mm	Menghini biopsy needle; 1.4 mm; 100 mm	330
<b>38-420-007</b>	Menghini jehla na biopsii; 1,6 mm; 70 mm	Menghini biopsy needle; 1.6 mm; 70 mm	330
<b>38-420-008</b>	Menghini jehla na biopsii; 1,8 mm; 100 mm	Menghini biopsy needle; 1.8 mm; 100 mm	330
<b>38-430-140</b>	Menghini jehla na biopsii; 1,4 mm; 168 mm	Menghini biopsy needle; 1.4 mm; 168 mm	330
<b>38-430-180</b>	Menghini jehla na biopsii; 1,8 mm; 168 mm	Menghini biopsy needle; 1.8 mm; 168 mm	330
<b>38-521-270</b>	Yankauer odsávačka; 27,0 cm	Yankauer suction tube; 27.0 cm	336
<b>38-521-270/1</b>	Yankauer spojka odsávačky	Yankauer suction connector only	336
<b>38-521-270/2</b>	Yankauer hlavička odsávačky	Yankauer suction head only	336
<b>38-523-235</b>	Andrew-Pynchon odsávačka; 23,5 cm	Andrew-Pynchon suction tube; 23.5 cm	336; 432–435
<b>38-550-010</b>	Poole odsávačka rovná; 22,0 cm; 10 mm	Poole suction tube; straight; 22.0 cm; 10 mm	336
<b>38-551-008</b>	Poole odsávačka zahnutá; 22 cm; 8 mm	Poole suction tube; curved; 22.0 cm; 8 mm	336
<b>38-571-006</b>	Frazier odsávačka; 17,0 cm; 6 Charr	Frazier suction tube; 17.0 cm; 6 Charr	334
<b>38-571-008</b>	Frazier odsávačka; 17,0 cm; 8 Charr	Frazier suction tube; 17.0 cm; 8 Charr	334
<b>38-571-010</b>	Frazier odsávačka; 17,0 cm; 10 Charr.	Frazier suction tube; 17.0 cm; 10 Charr.	334
<b>38-571-012</b>	Frazier odsávačka; 17,0 cm; 12 Charr.	Frazier suction tube; 17.0 cm; 12 Charr.	334
<b>38-572-005</b>	Rosen odsávačka rovná; 0,5 mm; 80 mm	Rosen suction tube straight; 0.5 mm; 80 mm	332
<b>38-572-006</b>	Rosen odsávačka rovná; 0,6 mm; 80 mm	Rosen suction tube straight; 0.6 mm; 80 mm	332
<b>38-572-007</b>	Rosen odsávačka rovná; 0,7 mm; 80 mm	Rosen suction tube straight; 0.7 mm; 80 mm	332
<b>38-572-009</b>	Rosen odsávačka rovná; 0,9 mm; 80 mm	Rosen suction tube straight; 0.9 mm; 80 mm	332
<b>38-572-010</b>	Rosen odsávačka rovná; 1,0 mm; 80 mm	Rosen suction tube straight; 1.0 mm; 80 mm	332
<b>38-572-012</b>	Rosen odsávačka rovná; 1,2 mm; 80 mm	Rosen suction tube straight; 1.2 mm; 80 mm	332
<b>38-572-014</b>	Rosen odsávačka rovná; 1,4 mm; 80 mm	Rosen suction tube straight; 1.4 mm; 80 mm	332
<b>38-572-015</b>	Rosen odsávačka rovná; 1,5 mm; 80 mm	Rosen suction tube straight; 1.5 mm; 80 mm	332
<b>38-572-018</b>	Rosen odsávačka rovná; 1,8 mm; 80 mm	Rosen suction tube straight; 1.8 mm; 80 mm	332
<b>38-572-020</b>	Rosen odsávačka rovná; 2,0 mm; 80 mm	Rosen suction tube straight; 2.0 mm; 80 mm	332
<b>38-572-025</b>	Rosen odsávačka rovná; 2,5 mm; 80 mm	Rosen suction tube straight; 2.5 mm; 80 mm	332
<b>38-572-030</b>	Rosen odsávačka rovná; 3,0 mm; 80 mm	Rosen suction tube straight; 3.0 mm; 80 mm	332
<b>38-573-005</b>	Rosen odsávačka lomená; 0,5 mm	Rosen suction tube angled; 0.5 mm	332
<b>38-573-006</b>	Rosen odsávačka lomená; 0,6 mm	Rosen suction tube angled; 0.6 mm	332
<b>38-573-007</b>	Rosen odsávačka lomená; 0,7 mm	Rosen suction tube angled; 0.7 mm	332
<b>38-573-009</b>	Rosen odsávačka lomená; 0,9 mm	Rosen suction tube angled; 0.9 mm	332
<b>38-573-010</b>	Rosen odsávačka lomená; 1,0 mm	Rosen suction tube angled; 1.0 mm	332
<b>38-573-012</b>	Rosen odsávačka lomená; 1,2 mm	Rosen suction tube angled; 1.2 mm	332
<b>38-573-014</b>	Rosen odsávačka lomená; 1,4 mm	Rosen suction tube angled; 1.4 mm	332
<b>38-573-015</b>	Rosen odsávačka lomená; 1,5 mm	Rosen suction tube angled; 1.5 mm	332
<b>38-573-018</b>	Rosen odsávačka lomená; 1,8 mm	Rosen suction tube angled; 1.8 mm	332
<b>38-573-020</b>	Rosen odsávačka lomená; 2,0 mm	Rosen suction tube angled; 2.0 mm	332
<b>38-573-025</b>	Rosen odsávačka lomená; 2,5 mm	Rosen suction tube angled; 2.5 mm	332
<b>38-573-030</b>	Rosen odsávačka lomená; 3,0 mm	Rosen suction tube angled; 3.0 mm	332
<b>38-591-030</b>	Luer-Lock kanyla sací a proplachovací; 3,0 mm; 12,0 cm	Luer-Lock suction and irrigating tube; 3.0 mm; 12.0 cm	334
<b>38-685-020</b>	Eicken-Killian kanyla proplachovací; 2,0 mm; 13,0 cm	Eicken-Killian wash tube; 2.0 mm; 13.0 cm	335
<b>38-685-025</b>	Eicken-Killian kanyla proplachovací; 2,5 mm; 13,0 cm	Eicken-Killian wash tube; 2.5 mm; 13.0 cm	335
<b>38-685-030</b>	Eicken-Killian kanyla proplachovací; 3,0 mm; 13,0 cm	Eicken-Killian wash tube; 3.0 mm; 13.0 cm	335
<b>38-685-040</b>	Eicken-Killian kanyla proplachovací; 4,0 mm; 13,0 cm	Eicken-Killian wash tube; 4.0 mm; 13.0 cm	335
<b>38-687-025</b>	Eicken kanyla proplachovací; lehce zahnutá; 2,5 mm	Eicken wash tube; slightly curved; 2.5 mm	334
<b>38-687-030</b>	Eicken kanyla proplachovací; lehce zahnutá; 3,0 mm	Eicken wash tube; slightly curved; 3.0 mm	334
<b>38-687-040</b>	Eicken kanyla proplachovací; lehce zahnutá; 4,0 mm	Eicken wash tube; slightly curved; 4.0 mm	334
<b>38-689-025</b>	Eicken kanyla proplachovací; silně zahnutá; 2,5 mm	Eicken wash tube; strongly curved; 2.5 mm	334
<b>38-689-030</b>	Eicken kanyla proplachovací; silně zahnutá; 3,0 mm	Eicken wash tube; strongly curved; 3.0 mm	334
<b>38-689-040</b>	Eicken kanyla proplachovací; silně zahnutá; 4,0 mm	Eicken wash tube; strongly curved; 4.0 mm	334
<b>418-515-020</b>	Fergusson odsávačka 6 Charr./Fr.; 2 mm; 17,0 cm	Fergusson suction tube 6 Charr./Fr.; 2 mm; 17.0 cm	333
<b>418-515-025</b>	Fergusson odsávačka 8 Charr./Fr.; 2 2/3 mm; 17,0 cm	Fergusson suction tube 8 Charr./Fr.; 2 2/3 mm; 17.0 cm	333
<b>418-515-030</b>	Fergusson odsávačka 9 Charr./Fr.; 3 mm; 17,0 cm	Fergusson suction tube 9 Charr./Fr.; 3 mm; 17.0 cm	333
<b>418-515-035</b>	Fergusson odsávačka 10 Charr./Fr.; 3 1/3 mm; 17,0 cm	Fergusson suction tube 10 Charr./Fr.; 3 1/3 mm; 17.0 cm	333
<b>418-515-040</b>	Fergusson odsávačka 12 Charr./Fr.; 4 mm; 17,0 cm	Fergusson suction tube 12 Charr./Fr.; 4 mm; 17.0 cm	333
<b>418-515-050</b>	Fergusson odsávačka 15 Charr./Fr.; 5 mm; 17,0 cm	Fergusson suction tube 15 Charr./Fr.; 5 mm; 17.0 cm	333
<b>418-598-010</b>	Pravaz jehla injekční LL Fig. 1; 0,90×38 mm	Pravaz injection needle LL Fig. 1; 0.90×38 mm	329
<b>418-598-020</b>	Pravaz jehla injekční LL Fig. 2; 0,80×32 mm	Pravaz injection needle LL Fig. 2; 0.80×32 mm	329
<b>418-598-120</b>	Pravaz jehla injekční LL Fig. 12; 0,70×32 mm	Pravaz injection needle LL Fig. 12; 0.70×32 mm	329
<b>418-598-140</b>	Pravaz jehla injekční LL Fig. 14; 0,65×28 mm	Pravaz injection needle LL Fig. 14; 0.65×28 mm	329
<b>418-598-160</b>	Pravaz jehla injekční LL Fig. 16; 0,60×25 mm	Pravaz injection needle LL Fig. 16; 0.60×25 mm	329
<b>418-598-180</b>	Pravaz jehla injekční LL Fig. 18; 0,50×23 mm	Pravaz injection needle LL Fig. 18; 0.50×23 mm	329
<b>418-598-200</b>	Pravaz jehla injekční LL Fig. 20; 0,45×20 mm	Pravaz injection needle LL Fig. 20; 0.45×20 mm	329
<b>418-628-120</b>	Tuohy jehla na biopsii; 1,20 mm; 76 mm	Tuohy biopsy needle; 1.20 mm; 76 mm	330
<b>418-628-140</b>	Tuohy jehla na biopsii; 1,40 mm; 76 mm	Tuohy biopsy needle; 1.40 mm; 76 mm	330
<b>418-628-160</b>	Tuohy jehla na biopsii; 1,60 mm; 76 mm	Tuohy biopsy needle; 1.60 mm; 76 mm	330
<b>431-576-000</b>	Dittel set dilatátorů urologických; 8-30 Charr./Fr.; 23 ks	Dittel bougies set 8-30 Charr./Fr.; 23 pieces	340
<b>431-576-090</b>	Dittel dilatátor urologický rovný; 9 Charr./Fr.	Dittel bougie urethral; 9 Charr./Fr.	340
<b>431-576-110</b>	Dittel dilatátor urologický rovný; 11 Charr./Fr.	Dittel bougie urethral; 11 Charr./Fr.	340
<b>431-576-130</b>	Dittel dilatátor urologický rovný; 13 Charr./Fr.	Dittel bougie urethral; 13 Charr./Fr.	340
<b>431-576-150</b>	Dittel dilatátor urologický rovný; 15 Charr./Fr.	Dittel bougie urethral; 15 Charr./Fr.	340

číslo – number	název	item	strana – page
431-576-170	Dittel dilatátor urologický rovný; 17 Charr./Fr.	Dittel bougie urethral; 17 Charr./Fr.	340
431-576-190	Dittel dilatátor urologický rovný; 19 Charr./Fr.	Dittel bougie urethral; 19 Charr./Fr.	340
431-576-210	Dittel dilatátor urologický rovný; 21 Charr./Fr.	Dittel bougie urethral; 21 Charr./Fr.	340
431-576-230	Dittel dilatátor urologický rovný; 23 Charr./Fr.	Dittel bougie urethral; 23 Charr./Fr.	340
431-576-250	Dittel dilatátor urologický rovný; 25 Charr./Fr.	Dittel bougie urethral; 25 Charr./Fr.	340
431-576-270	Dittel dilatátor urologický rovný; 27 Charr./Fr.	Dittel bougie urethral; 27 Charr./Fr.	340
431-576-290	Dittel dilatátor urologický rovný; 29 Charr./Fr.	Dittel bougie urethral; 29 Charr./Fr.	340
431-576-320	Dittel dilatátor urologický rovný; 32 Charr./Fr.	Dittel bougie urethral; 32 Charr./Fr.	340
432-985-030	Kyreta aspirační; 3 mm; 20,0 cm	Aspirating curette; 3 mm; 20,0 cm	488
432-985-040	Kyreta aspirační; 4,5 mm; 20,0 cm	Aspirating curette; 4,5 mm; 20,0 cm	488
432-985-060	Kyreta aspirační; 6,0 mm; 20,0 cm	Aspirating curette; 6,0 mm; 20,0 cm	488
432-985-080	Kyreta aspirační; 8,0 mm; 20,0 cm	Aspirating curette; 8,0 mm; 20,0 cm	488
432-985-100	Kyreta aspirační; 10,0 mm; 20,0 cm	Aspirating curette; 10,0 mm; 20,0 cm	488
432-985-120	Kyreta aspirační; 12,0 mm; 20,0 cm	Aspirating curette; 12,0 mm; 20,0 cm	488
432-985-140	Kyreta aspirační; 14,0 mm; 20,0 cm	Aspirating curette; 14,0 mm; 20,0 cm	488
432-985-500	Spojka kyrety aspirační	Connecting adaptor	488
437-648-000	Cottle drtič chrupavky	Cottle cartilage crusher	392; 433
456-602-500	Naběračka pro anatomii 50 cc	Medicine spoon graduated 50 cc	15
46-041-001	Killian zrcátko nosní; 35 mm; 13,0 cm	Killian nasal speculum; 35 mm; 13,0 cm	404; 433
46-041-002	Killian zrcátko nosní; 50 mm; 13,0 cm	Killian nasal speculum; 50 mm; 13,0 cm	404; 433
46-041-003	Killian zrcátko nosní; 75 mm; 13,0 cm	Killian nasal speculum; 75 mm; 13,0 cm	404; 433
46-041-004	Killian zrcátko nosní; 90 mm; 13,0 cm	Killian nasal speculum; 90 mm; 13,0 cm	404
60-321-000	Van Buren set sond urologických	Van Buren urethral sounds	341
60-321-008	Van Buren sonda urologická zahnutá; Charr. 8	Van Buren urethral sound; Charr. 8; curved	341
60-321-010	Van Buren sonda urologická zahnutá; Charr. 10	Van Buren urethral sound; Charr. 10; curved	341
60-321-012	Van Buren sonda urologická zahnutá; Charr. 12	Van Buren urethral sound; Charr. 12; curved	341
60-321-014	Van Buren sonda urologická zahnutá; Charr. 14	Van Buren urethral sound; Charr. 14; curved	341
60-321-016	Van Buren sonda urologická zahnutá; Charr. 16	Van Buren urethral sound; Charr. 16; curved	341
60-321-018	Van Buren sonda urologická zahnutá; Charr. 18	Van Buren urethral sound; Charr. 18; curved	341
60-321-020	Van Buren sonda urologická zahnutá; Charr. 20	Van Buren urethral sound; Charr. 20; curved	341
60-321-022	Van Buren sonda urologická zahnutá; Charr. 22	Van Buren urethral sound; Charr. 22; curved	341
60-321-024	Van Buren sonda urologická zahnutá; Charr. 24	Van Buren urethral sound; Charr. 24; curved	341
60-321-026	Van Buren sonda urologická zahnutá; Charr. 26	Van Buren urethral sound; Charr. 26; curved	341
60-321-028	Van Buren sonda urologická zahnutá; Charr. 28	Van Buren urethral sound; Charr. 28; curved	341
60-321-030	Van Buren sonda urologická zahnutá; Charr. 30	Van Buren urethral sound; Charr. 30; curved	341
60-321-032	Van Buren sonda urologická zahnutá; Charr. 32	Van Buren urethral sound; Charr. 32; curved	341
60-321-034	Van Buren sonda urologická zahnutá; Charr. 34	Van Buren urethral sound; Charr. 34; curved	341
60-321-036	Van Buren sonda urologická zahnutá; Charr. 36	Van Buren urethral sound; Charr. 36; curved	341
60-330-008	Dittel dilatátor urologický rovný; Charr./Fr. 8	Dittel urethral sound; straight; Charr./Fr. 8	340
60-330-010	Dittel dilatátor urologický rovný; Charr./Fr. 10	Dittel urethral sound; straight; Charr./Fr. 10	340
60-330-012	Dittel dilatátor urologický rovný; Charr./Fr. 12	Dittel urethral sound; straight; Charr./Fr. 12	340
60-330-014	Dittel dilatátor urologický rovný; Charr./Fr. 14	Dittel urethral sound; straight; Charr./Fr. 14	340
60-330-016	Dittel dilatátor urologický rovný; Charr./Fr. 16	Dittel urethral sound; straight; Charr./Fr. 16	340
60-330-018	Dittel dilatátor urologický rovný; Charr./Fr. 18	Dittel urethral sound; straight; Charr./Fr. 18	340
60-330-020	Dittel dilatátor urologický rovný; Charr./Fr. 20	Dittel urethral sound; straight; Charr./Fr. 20	340
60-330-022	Dittel dilatátor urologický rovný; Charr./Fr. 22	Dittel urethral sound; straight; Charr./Fr. 22	340
60-330-024	Dittel dilatátor urologický rovný; Charr./Fr. 24	Dittel urethral sound; straight; Charr./Fr. 24	340
60-330-026	Dittel dilatátor urologický rovný; Charr./Fr. 26	Dittel urethral sound; straight; Charr./Fr. 26	340
60-330-028	Dittel dilatátor urologický rovný; Charr./Fr. 28	Dittel urethral sound; straight; Charr./Fr. 28	340
60-330-030	Dittel dilatátor urologický rovný; Charr./Fr. 30	Dittel urethral sound; straight; Charr./Fr. 30	340
60-335-000	Dittel set dilatátorů urologických; 8-30 Charr./Fr.; 23 ks	Dittel urethral sound; set 8-30 Charr./Fr.	340
60-335-008	Dittel dilatátor urologický zahnutý; Charr./Fr. 8	Dittel urethral sound; curved; Charr./Fr. 8	340
60-335-009	Dittel dilatátor urologický zahnutý; Charr./Fr. 9	Dittel urethral sound; curved; Charr./Fr. 9	340
60-335-010	Dittel dilatátor urologický zahnutý; Charr./Fr. 10	Dittel urethral sound; curved; Charr./Fr. 10	340
60-335-011	Dittel dilatátor urologický zahnutý; Charr./Fr. 11	Dittel urethral sound; curved; Charr./Fr. 11	340
60-335-012	Dittel dilatátor urologický zahnutý; Charr./Fr. 12	Dittel urethral sound; curved; Charr./Fr. 12	340
60-335-013	Dittel dilatátor urologický zahnutý; Charr./Fr. 13	Dittel urethral sound; curved; Charr./Fr. 13	340
60-335-014	Dittel dilatátor urologický zahnutý; Charr./Fr. 14	Dittel urethral sound; curved; Charr./Fr. 14	340
60-335-015	Dittel dilatátor urologický zahnutý; Charr./Fr. 15	Dittel urethral sound; curved; Charr./Fr. 15	340
60-335-016	Dittel dilatátor urologický zahnutý; Charr./Fr. 16	Dittel urethral sound; curved; Charr./Fr. 16	340
60-335-017	Dittel dilatátor urologický zahnutý; Charr./Fr. 17	Dittel urethral sound; curved; Charr./Fr. 17	340
60-335-018	Dittel dilatátor urologický zahnutý; Charr./Fr. 18	Dittel urethral sound; curved; Charr./Fr. 18	340
60-335-019	Dittel dilatátor urologický zahnutý; Charr./Fr. 19	Dittel urethral sound; curved; Charr./Fr. 19	340
60-335-020	Dittel dilatátor urologický zahnutý; Charr./Fr. 20	Dittel urethral sound; curved; Charr./Fr. 20	340
60-335-021	Dittel dilatátor urologický zahnutý; Charr./Fr. 21	Dittel urethral sound; curved; Charr./Fr. 21	340
60-335-022	Dittel dilatátor urologický zahnutý; Charr./Fr. 22	Dittel urethral sound; curved; Charr./Fr. 22	340
60-335-023	Dittel dilatátor urologický zahnutý; Charr./Fr. 23	Dittel urethral sound; curved; Charr./Fr. 23	340
60-335-024	Dittel dilatátor urologický zahnutý; Charr./Fr. 24	Dittel urethral sound; curved; Charr./Fr. 24	340
60-335-025	Dittel dilatátor urologický zahnutý; Charr./Fr. 25	Dittel urethral sound; curved; Charr./Fr. 25	340
60-335-026	Dittel dilatátor urologický zahnutý; Charr./Fr. 26	Dittel urethral sound; curved; Charr./Fr. 26	340
60-335-027	Dittel dilatátor urologický zahnutý; Charr./Fr. 27	Dittel urethral sound; curved; Charr./Fr. 27	340
60-335-028	Dittel dilatátor urologický zahnutý; Charr./Fr. 28	Dittel urethral sound; curved; Charr./Fr. 28	340
60-335-029	Dittel dilatátor urologický zahnutý; Charr./Fr. 29	Dittel urethral sound; curved; Charr./Fr. 29	340
60-335-030	Dittel dilatátor urologický zahnutý; Charr./Fr. 30	Dittel urethral sound; curved; Charr./Fr. 30	340
60-421-008	Katetr kovový pro muže; Charr./Fr. 8; 27,0 cm	Metal catheter for men; 27 cm; Charr./Fr. 8	342
60-421-010	Katetr kovový pro muže; Charr./Fr. 10; 27,0 cm	Metal catheter for men; 27 cm; Charr./Fr. 10	342
60-421-012	Katetr kovový pro muže; Charr./Fr. 12; 27,0 cm	Metal catheter for men; 27 cm; Charr./Fr. 12	342
60-421-014	Katetr kovový pro muže; Charr./Fr. 14; 27,0 cm	Metal catheter for men; 27 cm; Charr./Fr. 14	342
60-421-016	Katetr kovový pro muže; Charr./Fr. 16; 27,0 cm	Metal catheter for men; 27 cm; Charr./Fr. 16	342
60-421-018	Katetr kovový pro muže; Charr./Fr. 18; 27,0 cm	Metal catheter for men; 27 cm; Charr./Fr. 18	342
60-421-020	Katetr kovový pro muže; Charr./Fr. 20; 27,0 cm	Metal catheter for men; 27 cm; Charr./Fr. 20	342
60-421-022	Katetr kovový pro muže; Charr./Fr. 22; 27,0 cm	Metal catheter for men; 27 cm; Charr./Fr. 22	342
60-421-024	Katetr kovový pro muže; Charr./Fr. 24; 27,0 cm	Metal catheter for men; 27 cm; Charr./Fr. 24	342
60-441-008	Katetr kovový pro ženy; Charr./Fr. 8; 15,0 cm	Metal catheter for women; 15 cm; Charr./Fr. 8	342



číslo – number	název	item	strana – page
60-441-010	Katetr kovový pro ženy; Charr./Fr. 10; 15,0 cm	Metal catheter for women; 15 cm; Charr./Fr. 10	342
60-441-012	Katetr kovový pro ženy; Charr./Fr. 12; 15,0 cm	Metal catheter for women; 15 cm; Charr./Fr. 12	342
60-441-014	Katetr kovový pro ženy; Charr./Fr. 14; 15,0 cm	Metal catheter for women; 15 cm; Charr./Fr. 14	342
60-441-016	Katetr kovový pro ženy; Charr./Fr. 16; 15,0 cm	Metal catheter for women; 15 cm; Charr./Fr. 16	342
60-441-018	Katetr kovový pro ženy; Charr./Fr. 18; 15,0 cm	Metal catheter for women; 15 cm; Charr./Fr. 18	342
60-441-020	Katetr kovový pro ženy; Charr./Fr. 20; 15,0 cm	Metal catheter for women; 15 cm; Charr./Fr. 20	342
60-441-022	Katetr kovový pro ženy; Charr./Fr. 22; 15,0 cm	Metal catheter for women; 15 cm; Charr./Fr. 22	342
60-441-024	Katetr kovový pro ženy; Charr./Fr. 24; 15,0 cm	Metal catheter for women; 15 cm; Charr./Fr. 24	342
60-782-000	Otís uretrotom mod. Keitzer; pro dospělé	Otis urethrotome; mod. Keitzer; for adults	343
60-782-001	Nůž pro Otis uretrotom; mod. Keitzer; pro dospělé	Otis urethrotome; mod. Keitzer; for adults; knife only	343
62-721-230	Novak sací kyreta na biopsii; 4 mm; 23,0 cm	Novak aspiration curette; 4 mm; 23 cm	489
62-744-130	Kyreta děložní; ostrá; rigidní; Fig. 13; 34,0 cm	Uterine Curette; 34.0 cm; sharp; rigid; Fig. 13	486
62-744-140	Kyreta děložní; ostrá; rigidní; Fig. 14; 34,0 cm	Uterine Curette; 34.0 cm; sharp; rigid; Fig. 14	486
62-744-150	Kyreta děložní; ostrá; rigidní; Fig. 15; 34,0 cm	Uterine Curette; 34.0 cm; sharp; rigid; Fig. 15	486
62-744-160	Kyreta děložní; ostrá; rigidní; Fig. 16; 34,0 cm	Uterine Curette; 34.0 cm; sharp; rigid; Fig. 16	486
62-746-130	Kyreta děložní; ostrá; ohebná; Fig. 13; 34,0 cm	Uterine Curette; 34.0 cm; sharp; malleable; Fig. 13	486
62-746-140	Kyreta děložní; ostrá; ohebná; Fig. 14; 34,0 cm	Uterine Curette; 34.0 cm; sharp; malleable; Fig. 14	486
62-746-150	Kyreta děložní; ostrá; ohebná; Fig. 15; 34,0 cm	Uterine Curette; 34.0 cm; sharp; malleable; Fig. 15	486
62-746-160	Kyreta děložní; ostrá; ohebná; Fig. 16; 34,0 cm	Uterine Curette; 34.0 cm; sharp; malleable; Fig. 16	486
62-754-130	Kyreta děložní; tupá; rigidní; Fig. 13; 34,0 cm	Uterine Curette; 34.0 cm; blunt; rigid; Fig. 13	486
62-754-140	Kyreta děložní; tupá; rigidní; Fig. 14; 34,0 cm	Uterine Curette; 34.0 cm; blunt; rigid; Fig. 14	486
62-754-150	Kyreta děložní; tupá; rigidní; Fig. 15; 34,0 cm	Uterine Curette; 34.0 cm; blunt; rigid; Fig. 15	486
62-754-160	Kyreta děložní; tupá; rigidní; Fig. 16; 34,0 cm	Uterine Curette; 34.0 cm; blunt; rigid; Fig. 16	486
62-756-130	Kyreta děložní; tupá; ohebná; Fig. 13; 34,0 cm	Uterine Curette; 34.0 cm; blunt; malleable; Fig. 13	486
62-756-140	Kyreta děložní; tupá; ohebná; Fig. 14; 34,0 cm	Uterine Curette; 34.0 cm; blunt; malleable; Fig. 14	486
62-756-150	Kyreta děložní; tupá; ohebná; Fig. 15; 34,0 cm	Uterine Curette; 34.0 cm; blunt; malleable; Fig. 15	486
62-756-160	Kyreta děložní; tupá; ohebná; Fig. 16; 34,0 cm	Uterine Curette; 34.0 cm; blunt; malleable; Fig. 16	486
62-980-000	Schultze set pro hystero-salpingografii; komplet v krabičce	Schultze set for hystero-salpingography; complete in case	441
62-980-001	Manometer pro Schulzte salpingograph	Manometer only for Schulzte Salpingograph	441
67-720-001	Schede lžička kostní; 17 cm; Fig.000	Schede bone curette; 17 cm; Fig.000	276
67-720-002	Schede lžička kostní; 17 cm; Fig. 00	Schede bone curette; 17 cm; Fig. 00	276
67-720-003	Schede lžička kostní; 17 cm; Fig. 0	Schede bone curette; 17 cm; Fig. 0	276
67-720-010	Schede lžička kostní; 17 cm; Fig. 1	Schede bone curette; 17 cm; Fig. 1	276
67-720-020	Schede lžička kostní; 17 cm; Fig. 2	Schede bone curette; 17 cm; Fig. 2	276
67-720-030	Schede lžička kostní; 17 cm; Fig. 3	Schede bone curette; 17 cm; Fig. 3	276
67-720-040	Schede lžička kostní; 17 cm; Fig. 4	Schede bone curette; 17 cm; Fig. 4	276
67-724-000	Volkman lžička kostní; 17 cm; Fig. 0000	Volkman bone curette; 17 cm; Fig. 0000	276
67-724-001	Volkman lžička kostní; 17 cm; Fig. 000	Volkman bone curette; 17 cm; Fig. 000	276
67-724-002	Volkman lžička kostní; 17 cm; Fig. 00	Volkman bone curette; 17 cm; Fig. 00	276
67-724-003	Volkman lžička kostní; 17 cm; Fig. 0	Volkman bone curette; 17 cm; Fig. 0	276
67-724-010	Volkman lžička kostní; 17 cm; Fig. 1	Volkman bone curette; 17 cm; Fig. 1	276
67-724-020	Volkman lžička kostní; 17 cm; Fig. 2	Volkman bone curette; 17 cm; Fig. 2	276
67-724-030	Volkman lžička kostní; 17 cm; Fig. 3	Volkman bone curette; 17 cm; Fig. 3	276
67-724-040	Volkman lžička kostní; 17 cm; Fig. 4	Volkman bone curette; 17 cm; Fig. 4	276
67-724-050	Volkman lžička kostní; 17 cm; Fig. 5	Volkman bone curette; 17 cm; Fig. 5	276
67-724-060	Volkman lžička kostní; 17 cm; Fig. 6	Volkman bone curette; 17 cm; Fig. 6	276
67-728-001	Bruns lžička kostní; 17 cm; Fig. 000	Bruns bone curette; 17 cm; Fig. 000	277
67-728-002	Bruns lžička kostní; 17 cm; Fig. 00	Bruns bone curette; 17 cm; Fig. 00	277
67-728-003	Bruns lžička kostní; 17 cm; Fig. 0	Bruns bone curette; 17 cm; Fig. 0	277
67-728-010	Bruns lžička kostní; 17 cm; Fig. 1	Bruns bone curette; 17 cm; Fig. 1	277
67-728-020	Bruns lžička kostní; 17 cm; Fig. 2	Bruns bone curette; 17 cm; Fig. 2	277
67-728-030	Bruns lžička kostní; 17 cm; Fig. 3	Bruns bone curette; 17 cm; Fig. 3	277
67-728-040	Bruns lžička kostní; 17 cm; Fig. 4	Bruns bone curette; 17 cm; Fig. 4	277
67-728-050	Bruns lžička kostní; 17 cm; Fig. 5	Bruns bone curette; 17 cm; Fig. 5	277
67-728-060	Bruns lžička kostní; 17 cm; Fig. 6	Bruns bone curette; 17 cm; Fig. 6	277
67-732-001	Spratt lžička kostní; 16 cm; Fig. 000	Spratt bone curette; 16 cm; Fig. 000	277
67-732-002	Spratt lžička kostní; 16 cm; Fig. 00	Spratt bone curette; 16 cm; Fig. 00	277
67-732-003	Spratt lžička kostní; 16 cm; Fig.0	Spratt bone curette; 16 cm; Fig.0	277
67-732-004	Spratt lžička kostní; 16 cm; Fig. 0000	Spratt bone curette; 16 cm; Fig. 0000	277
67-732-010	Spratt lžička kostní; 16 cm; Fig. 1	Spratt bone curette; 16 cm; Fig. 1	277
67-732-020	Spratt lžička kostní; 16 cm; Fig. 2	Spratt bone curette; 16 cm; Fig. 2	277
67-732-030	Spratt lžička kostní; 16 cm; Fig. 3	Spratt bone curette; 16 cm; Fig. 3	277
67-732-040	Spratt lžička kostní; 16 cm; Fig. 4	Spratt bone curette; 16 cm; Fig. 4	277
67-732-050	Spratt lžička kostní; 16 cm; Fig. 5	Spratt bone curette; 16 cm; Fig. 5	277
95013	Pinzeta bipolární zahnutá; 0,5x8 mm; 16,0 cm	Bipolar forceps bent; 0.5x8 mm; 16.0 cm	435
95131	Pinzeta bipolární bajonetová; 1x6 mm; 22,0 cm	Bipolar forceps bay-shaped; 1x6 mm; 22.0 cm	434
AE870/08	Michel svorka šicí; 10 balení; 1000 ks; 7,5x1,75 mm	Michel clips; 10 pack; 1000 pcs; 7.5x1.75 mm	317
AE870/11	Michel svorka šicí; 10 balení; 1000 ks; 11,0x2,5 mm	Michel clips; 10 pack; 1000 pcs; 11.0x2.5 mm	317
AE870/12	Michel svorka šicí; 10 balení; 1000 ks; 12,0x3,0 mm	Michel clips; 10 pack; 1000 pcs; 12.0x3.0 mm	317
AE870/14	Michel svorka šicí; 10 balení; 1000 ks; 14,0x3,0 mm	Michel clips; 10 pack; 1000 pcs; 14.0x3.0 mm	317
AE870/16	Michel svorka šicí; 10 balení; 1000 ks; 16,0x3,0 mm	Michel clips; 10 pack; 1000 pcs; 16.0x3.0 mm	317
AE870/18	Michel svorka šicí; 10 balení; 1000 ks; 18,0x3,0 mm	Michel clips; 10 pack; 1000 pcs; 18.0x3.0 mm	317
AE870/20	Michel svorka šicí; 10 balení; 1000 ks; 20,0x3,0 mm	Michel clips; 10 pack; 1000 pcs; 20.0x3.0 mm	317
AE870/22	Michel svorka šicí; 10 balení; 1000 ks; 22,0x3,0 mm	Michel clips; 10 pack; 1000 pcs; 22.0x3.0 mm	317
J-14-054	Yasargil odsávačka; 11 cm; 150x1,5 mm	Yasargil suction tube; 11 cm; 150x1.5 mm	335
J-14-055	Yasargil odsávačka; 11 cm; 150x2,0 mm	Yasargil suction tube; 11 cm; 150x2.0 mm	335
J-14-057	Yasargil odsávačka; 11 cm; 150x2,5 mm	Yasargil suction tube; 11 cm; 150x2.5 mm	335
J-14-058	Yasargil odsávačka; 11 cm; 150x3,5 mm	Yasargil suction tube; 11 cm; 150x3.5 mm	335
KS 230/08	Heifetz lopatka mozková; 8 mm; 20,0 cm	Heifetz brain spatula; 8 mm; 20.0 cm	546
KS 230/11	Heifetz lopatka mozková; 11 mm; 20,0 cm	Heifetz brain spatula; 11 mm; 20.0 cm	546
KS 230/14	Heifetz lopatka mozková; 14 mm; 20,0 cm	Heifetz brain spatula; 14 mm; 20.0 cm	546
KS 230/17	Heifetz lopatka mozková; 17 mm; 20,0 cm	Heifetz brain spatula; 17 mm; 20.0 cm	546
KS 230/20	Heifetz lopatka mozková; 20 mm; 20,0 cm	Heifetz brain spatula; 20 mm; 20.0 cm	546
KS 232/01	Olivecrona lopatka mozková; vydutá; 7+9 mm; 18,0 cm	Olivecrona brain spatula; concave; 7+9 mm; 18.0 cm	546

číslo – number	název	item	strana – page
KS 232/02	Olivecrona lopatka mozková; vydutá; 11+13 mm; 18,0 cm	Olivecrona brain spatula; concave; 11+13 mm; 18,0 cm	546
KS 232/03	Olivecrona lopatka mozková; vydutá; 15+18 mm; 18,0 cm	Olivecrona brain spatula; concave; 15+18 mm; 18,0 cm	546
KS 232/04	Olivecrona lopatka mozková; vydutá; 18+22 mm; 18,0 cm	Olivecrona brain spatula; concave; 18+22 mm; 18,0 cm	546
KS 233/01	Olivecrona lopatka mozková; vypouklá; 7+9 mm; 18,0 cm	Olivecrona brain spatula; convex; 7+9 mm; 18,0 cm	546
KS 233/02	Olivecrona lopatka mozková; vypouklá; 11+13 mm; 18,0 cm	Olivecrona brain spatula; convex; 11+13 mm; 18,0 cm	546
KS 233/03	Olivecrona lopatka mozková; vypouklá; 15+18 mm; 18,0 cm	Olivecrona brain spatula; convex; 15+18 mm; 18,0 cm	546
KS 233/04	Olivecrona lopatka mozková; vypouklá; 18+22 mm; 18,0 cm	Olivecrona brain spatula; convex; 18+22 mm; 18,0 cm	546
KS 236/01	Lopatka mozková; ohebná; 7+9 mm; 18,0 cm	Brain spatula; malleable; 7+9 mm; 18,0 cm	546
KS 236/02	Lopatka mozková; ohebná; 11+13 mm; 18,0 cm	Brain spatula; malleable; 11+13 mm; 18,0 cm	546
KS 236/03	Lopatka mozková; ohebná; 15+18 mm; 18,0 cm	Brain spatula; malleable; 15+18 mm; 18,0 cm	546
KS 236/04	Lopatka mozková; ohebná; 18+22 mm; 18,0 cm	Brain spatula; malleable; 18+22 mm; 18,0 cm	546
KS 237/12	Lopatka mozková; ohebná; 12 mm; 20,0 cm	Brain spatula; malleable; 12 mm; 20,0 cm	546
KS 237/17	Lopatka mozková; ohebná; 17 mm; 20,0 cm	Brain spatula; malleable; 17 mm; 20,0 cm	546
KS 627/01	Disektor na mozkovou plenu tupý; 3 mm; 18,5 cm	Dura dissector blunt; 3 mm; 18,5 cm	548
KS 627/02	Disektor na mozkovou plenu tupý; 3 mm; 21,5 cm	Dura dissector blunt; 3 mm; 21,5 cm	548
KS 627/03	Disektor na mozkovou plenu tupý; 23,0 cm	Dura dissector blunt; 23,0 cm	548
KS 628/24	Davis disektor na mozkovou plenu; 24,5 cm	Davis dura dissector; 24,5 cm	548
KS 629/01	Toennis disektor na mozkovou plenu; 24 cm	Toennis dura dissector; 24 cm	548
KS 629/02	Toennis disektor na mozkovou plenu; 24 cm	Toennis dura dissector; 24 cm	548
KS 631/21	Sachs disektor na mozkovou plenu; 21 cm	Sachs dura dissector; 21,0 cm	549
KS 632/21	Sachs disektor na mozkovou plenu; 21 cm	Sachs dura dissector; 21,0 cm	549
KS 633/01	Frazier disektor na mozkovou plenu; 15 cm	Frazier dura dissector; 15,0 cm	549
KS 633/02	Hoehn disektor na mozkovou plenu; 15 cm	Hoehn dura dissector; 15,0 cm	549
KS 633/03	Hoehn disektor na mozkovou plenu; 15 cm	Hoehn dura dissector; 15,0 cm	549
KS 634/18	Olivercrona disektor na mozkovou plenu; 18 cm	Olivercrona dura dissector; 18 cm	550
KS 634/24	Olivercrona disektor na mozkovou plenu; 24 cm	Olivercrona dura dissector; 24 cm	550
KS 635/20	Olivercrona disektor na mozkovou plenu; 19,5 cm	Olivercrona dura dissector; 19,5 cm	550
KS 635/24	Olivercrona disektor na mozkovou plenu; 24 cm	Olivercrona dura dissector; 24 cm	550
KS 636/21	Milligan disektor na mozkovou plenu; 21 cm	Milligan dura dissector; 15 cm	550
KS 637/22	Disektor na mozkovou plenu; 22 cm	Dura dissector; 22 cm	550
KS 638/01	Penfield disektor na mozkovou plenu fig.1; 17,5 cm	Penfield dura dissector fig.1; 17,5 cm	551
KS 638/02	Penfield disektor na mozkovou plenu fig.2; 19,5 cm	Penfield dura dissector fig.2; 19,5 cm	551
KS 638/03	Penfield disektor na mozkovou plenu fig.3; 19,5 cm	Penfield dura dissector fig.3; 19,5 cm	551
KS 638/04	Penfield disektor na mozkovou plenu fig.4; 20,5 cm	Penfield dura dissector fig.4; 20,5 cm	551
KS 638/05	Penfield disektor na mozkovou plenu fig.5; 29,0 cm	Penfield dura dissector fig.5; 29,0 cm	551
KS 820/01	Cushing-Landolt nástroj na hypofýzu; 70×15 mm	Cushing-Landolt specula for hypophys.; 70×15 mm	547
KS 820/02	Cushing-Landolt nástroj na hypofýzu 90×15 mm	Cushing-Landolt specula for hypophys.; 90×15 mm	547
KS 820/03	Cushing-Landolt nástroj na hypofýzu; 110×15 mm	Cushing-Landolt specula for hypophys.; 110×15 mm	547
KS 821/21	Landolt kleště na rozevírání zrcadla; 21,5 cm	Landolt spreader for specula for hypophysectomy; 21.5 cm	547
KS 822/04	Cottle dláto; 4 mm; 18,0 cm	Cottle osteotome; 4 mm; 18,0 cm	547
KS 830/18	Ray nástroj pituitární; 18,0 cm	Ray pituitary instrument; 18,0 cm	555
KS 831/18	Ray nástroj pituitární; 18,0 cm	Ray pituitary instrument; 18,0 cm	555
KS 832/04	Hardy nástroj pituitární; 26,0 cm	Hardy pituitary instrument; 26,0 cm	555
KS 832/06	Hardy nástroj pituitární; 26,0 cm	Hardy pituitary instrument; 26,0 cm	555
KS 834/01	Nicola nástroj pituitární; 21,5 cm	Nicola pituitary instrument; 21,5 cm	555
KS 834/02	Nicola nástroj pituitární; 21,5 cm	Nicola pituitary instrument; 21,5 cm	555
KS 835/22	Nicola nástroj pituitární; 21,5 cm	Nicola pituitary instrument; 21,5 cm	555
KS 836/22	Nicola nástroj pituitární; 21,5 cm	Nicola pituitary instrument; 21,5 cm	555
KS 837/01	Hardy nástroj pituitární; 24,5 cm	Hardy pituitary instrument; 24,5 cm	556
KS 837/02	Hardy nástroj pituitární; 24,5 cm	Hardy pituitary instrument; 24,5 cm	556
KS 837/03	Hardy nástroj pituitární; 24,5 cm	Hardy pituitary instrument; 24,5 cm	556
KS 837/04	Hardy nástroj pituitární; 24,5 cm	Hardy pituitary instrument; 24,5 cm	556
KS 838/25	Hardy nástroj pituitární; 24,5 cm	Hardy pituitary instrument; 24,5 cm	556
KS 839/01	Hardy-Fahlbusch nástroj pituitární; 24,5 cm	Hardy-Fahlbusch pituitary instrument; 24,5 cm	556
KS 839/02	Hardy-Fahlbusch nástroj pituitární; 24,5 cm	Hardy-Fahlbusch pituitary instrument; 24,5 cm	556
KS 840/01	Landolt nástroj pituitární; 26,0 cm	Landolt pituitary instrument; 26,0 cm	557
KS 840/02	Landolt nástroj pituitární; 26,0 cm	Landolt pituitary instrument; 26,0 cm	557
KS 841/26	Landolt nástroj pituitární; 26,0 cm	Landolt pituitary instrument; 26,0 cm	557
KS 842/26	Landolt nástroj pituitární; 26,0 cm	Landolt pituitary instrument; 26,0 cm	557
KS 843/26	Landolt nástroj pituitární; 26,0 cm	Landolt pituitary instrument; 26,0 cm	557
KS 844/26	Fahlbusch nástroj pituitární; 26,0 cm	Fahlbusch pituitary instrument; 26,0 cm	557
KS 845/26	Fahlbusch nástroj pituitární; 26,0 cm	Fahlbusch pituitary instrument; 26,0 cm	557
KS 846/26	Hosobuchi nástroj pituitární; 26,0 cm	Hosobuchi pituitary instrument; 26,0 cm	558
KS 847/22	Landolt-Reulen nástroj pituitární; 2,2 mm	Landolt-Reulen pituitary instrument; 2,2 mm	558
KS 847/32	Landolt-Reulen nástroj pituitární; 3,2 mm	Landolt-Reulen pituitary instrument; 3,2 mm	558
KS 848/25	Landolt-Reulen nástroj pituitární; 2,5 mm	Landolt-Reulen pituitary instrument; 2,5 mm	558
KS 849/17	Landolt-Reulen nástroj pituitární; 1,7 mm	Landolt-Reulen pituitary instrument; 1,7 mm	558
KS 850/20	Landolt-Reulen nástroj pituitární; 2,0 mm	Landolt-Reulen pituitary instrument; 2,0 mm	558



## A

Adaptér k optice	364
Adaptér ke světelnému zdroji	364
Adlerkreutz pinzeta chirurgická	81
Adson kanyla aspirační	334
Adson pinzeta anatomická	78, 93
Adson pinzeta chirurgická	78, 93
Adson rozvěrač	233, 237
Adson svorka na cévy	112
Adson-Brown pinzeta chirurgická	78
Agnew jehla paracentézní	365
Alexander kleště na biopsii	453
Allis kleště na střeva	197
Allis svorka chirurgická	100
Allison lopatka na plíce	253
Alm rozvěrač	231
Anderson-Adson rozvěrač	233
Anderson-Neivert dláto nosní	428
Andrew-Pynchon odsávačka	336, 432, 433, 434, 435
Aplikátor sací na hemoroidy	349
Asch kleště na rovnání přepážky	392
Aufricht (Walter) hák	394
Aufricht hák	394
Aufricht pilník nosní	420
Auvarad zrcadlo poševní	471

## B

Babcock svorka chirurgická	98
Babinsky kladívko	13
Baby-Adson svorka na cévy	112, 435
Baby-Crile-Wood jehelec	301, 435
Baby-Mikulicz svorka na pobřišnici	128
Baby-Mixer svorka preparační	117
Baby-Satinsky svorka cévní	167
Baby-Tischler kleště na biopsii	449
Backhaus svorka na papír	168
Backhaus svorka na prádlo	169, 432, 434
Backhaus svorka s kuličkou	168
Backhaus-Clip svorka na prádlo	169
Baginsky nůž hrtanový	370
Bainbridge svorka atraumatická	138
Bainbridge svorka na cévy	113
Bakeš pátradlo na žlučovod	322
Bakeš sada pátradel na žlučovod	322
Balfour rozvěrač břišní	242
Balfour-Baby rozvěrač břišní	242
Ballenger dláto nosní	425
Ballenger nůž na nosní přepážku	369, 433
Barbara háček	366
Barbara jehla	366, 367
Barnhill kyreta na mandle	416
Baron odsávačka	333
Barraquer jehelec mikro	308, 312
Barraquer nůžky na duhovku	51
Barrett kleště gynekologické	456
Bartl kleště na vytažení kostních prutů	191
Beacham amniotom	466
Beck svorka atraumatická	153, 159
Beckmann kyreta na mandle	415
Beckmann kyreta nosohltanová	415, 432
Beckmann rozvěrač	234
Beckmann-Eaton rozvěrač	234
Beer pinzeta na řasy	89
Beeson kleště na sádrové obvazy	189
Bellucci nástroj mikro	524
Bellucci nůžky ušní	373
Bengolea svorka na cévy	114
Bensaude anoskop s obturátorem	258

Berger kleště na biopsii	454
Berliner kladívko reflexní	14
Bernhard svorka na prádlo	168
Berry jehelec	306
Bethune kleště na žebra	182
Beyer kleště štípací na kosti	177
Biemer háček na nervy	532
Bier jehla na biopsii	330
Billeau smyčka drátěná	414
Blake kyreta děložní	487
Blascovics pinzeta na operaci šilhání	88
Blount hák na meniskusu	225
Blount páka kostní	266
Blumenthal kleště štípací na kosti	173
Böhler kleště štípací na kosti	176
Bonney pinzeta chirurgická	82, 93
Bowmann pátradlo oční	325
Boynton jehelec oční	296, 305
Bozemann jehelec	302, 434
Bozemann kleště tamponové	200
Braun cranioclast	464
Braun hák dekapilační	466
Braun-Stadler nůžky pro episiotomii	35, 443
Breisky zrcadlo poševní	471
Bridge svorka preparační	118
Brown pinzeta chirurgická	80
Bruenings balónek pro otoskop	403
Bruenings držák jazyka	400
Bruenings kleště na nosní přepážku	379, 432
Bruenings koncovka	384, 385
Bruenings lopatka na jazyk	400, 434
Bruenings nůž nosní	370
Bruenings otoskop	403
Bruenings skřípec na mandle	417, 434
Bruenings zrcátko ušní	403
Brunner hák na rány	217
Brunner jehla podvazovací	315
Brunner kleště na žebra	183
Bruns lžička kostní	277
Bruns nůžky na sádrové obvazy	56
Buck kladívko	13
Buck kyreta ušní	413
Buchwald lopatka na jazyk	400
Bumm kyreta děložní	487
Burke kleště na biopsii	448

## C

Caspar hák	538
Caspar kleště na ploténky	517
Caspar lopatka	536-539
Caspar nástroj mikro	533, 534
Caspar rozvěrač	539
Caspar rozvěrač krční	536, 538
Castroviejo jehelec	306, 307, 309
Castroviejo jehelec mikro	307, 309
Castroviejo nůžky na duhovku	52
Castroviejo nůžky oční	52
Castroviejo pinzeta na rohovku	89
Catlin nůž amputační	25
Cinelli dláto	427
Cleveland kleště štípací	181
Cleveland kleště štípací na kosti	173
Cleveland-Gardner kleště štípací	180
Cloward kleště	518
Cloward lžička	280
Cloward modif. rozvěrač	542
Cloward rozvěrač plotének	543, 544
Coakley kyreta nosní	414
Collin držátko skalpelových čepelek	19

Collin dynamometr	16	De Bakey-Carotis bulldog svorka	133
Collin kleště na jazyk	393	De Bakey-Mosquito svorka atraumatická	135
Collin kleště na výrustky	197	De Bakey-Pean svorka atraumatická	135
Collin kleště tamponové	200	De Bakey-Satinsky bulldog svorka	133
Collin kyreta děložní	487	De Lee kleště porodní	462
Collin nůž amputační	25	De Vilbiss kleště kraniální	523
Collin rozvěrač břišní	246	Deaver hák břišní	222, 223
Collin svorka šicí	317	Deaver nůžky chirurgické	34
Collin zrcadlo poševní	473	Déjerine kladívko	14
Collin-Baby rozvěrač břišní	246	Déjerine kladívko s jehlou	14
Collin-Duval pinzeta úchopná	81	Denhart rozvěrač úst	397
Cone rozvěrač	234	Dennis-Browne rozvěrač břišní	243
Converse dláto nosní	428	Derf jehelec	300
Converse nůž nosní	370	Derra svorka atraumatická	152
Converse pilník nosní	421	Deschamps jehla podvazovací	314, 435
Cooley svorka atraumatická	155–158, 161	Desjardines pátradlo na žlučovod	322
Cooley-Derra svorka atraumatická	159	Desjardins svorka na žlučovod	123
Cordes koncovka	385	Desmarres držátko víček	209
Coryllos kleště na žebra	182	Desmarres pinzeta na chalazia	88
Cottle dláto	547	Dieffenbach skalpel oční	23
Cottle dláto nosní	426	Dieffenbach svorka na cévy	99
Cottle drtič chrupavky	392, 433	Dieter kleště štípací mikro	375
Cottle háček	395	Diethrich jehelec mikro	307, 509
Cottle hák	395	Dietrich svorka atraumatická	151
Cottle Kazanjian kleště štípací	180	Dilatátor slzných bodů	325
Cottle nůž nosní	370	Dilatátor urologický	339
Cottle nůžky nosní	48	Disektor na mozkovou plenu	548, 550
Cottle páčidlo nosní	408, 409, 433	Dittel dilatátor urologický	340
Cottle pilník nosní	420, 423	Dláto na nosní plastiku	424, 433
Cottle-Neivert hák	395	Dláto nosní	424
Crafoord nůžky pro lobektomii	47	Dláto ortopedické	561
Crafoord svorka na cévy	115	Dláto žlábkové	292
Crafoord-Sellors svorka bronchiální	114	Douay kleště na biopsii	454
Craig kleště na nosní přepážku	379	Doyen nůžky břišní	35
Craig-Domnick kleště na nosní přepážku	379	Doyen svorka na prádlo	168
Crile jehelec	296, 304	Doyen škrabka na žebra	270
Crile svorka na cévy	106	Doyen šroub na myomy	490
Crile-Rankin svorka na cévy	106	Doyen zrcadlo poševní	470
Crile-Wood jehelec	301	Drátek pro výtěry	431
Crura-Nipper kleště ušní štípací	375	Držátko	323
Cusco zrcadlo poševní	472, 477	Držátko drátěných pilek	559
Cusco-suisse zrcadlo poševní	472	Držátko skalpelových čepelek	19, 433–435
Cusco-virgin zrcadlo poševní	472	Držátko zrcátek hrtanových	406
Cushing hák	208, 209	Dubois nůžky gynekologické	36, 444
Cushing kleště	516	Duckbill kleště ušní	390
Cushing pinzeta anatomická	79, 93	Durante pinzeta chirurgická	82
Cushing pinzeta chirurgická	79	Duval kleště na plíce okénkové	196
Cushing-Landolt nástroj na hypofýzu	547	Duval pinzeta chirurgická	82
Cushing-Taylor pinzeta	93		

## Č

Čepel k transplantačnímu noži Schink	28
Čepel náhradní k noži nosnímu Bruenings	370
Čepel náhradní pro La Force	371
Čepel pro nůž transplantační	28
Čepelka skalpelová	20

## D

Dahlgreen kleště kraniální	523
Dale svorka atraumatická	152
Dandy háček na nervy	531
Dandy svorka na cévy	101
Dardik svorka atraumatická	160
Darling rozvěrač	235
Dartigues kleště děložní	460
Daviel lžička oční s lopatkou	279
Davis disektor na mozkovou plenu	548
De Bakey bulldog svorka atraumatická	131
De Bakey jehelec	298
De Bakey nůžky	43, 65
De Bakey nůžky na cévy	45
De Bakey odsávačka	336
De Bakey pinzeta atraumatická	91, 93, 137, 139–143, 145, 149, 154, 165
De Bakey-Bahnsen svorka atraumatická	145

## E

Echlin kleště štípací	177
Eicken kanyla proplachovací	334
Eicken-Killian kanyla proplachovací	335
Elektrická pilka na sádrové obvazy	283
Elschnig pinzeta fixační	87
Emmet hák na fistuli	467
Engel pilka na sádrové obvazy	283
Engl. Modell svorka na prádlo	168
Eppendorf kleště na biopsii	454
Eppendorf koncovka	455
Esmarch nůžky na obvazy	56
Eufrate Pasque jehelec	299
Extraktor kovový	495

## F

Fahlbusch nástroj mikro	524
Fahlbusch nástroj pituitární	557
Farabeuf hák	227
Farabeuf kleště repoziční	194
Farabeuf škrabka	269
Farabeuf-Lambotte kleště repoziční	194
Farrion zrcátko ušní	402
Faulkner kyreta nosní	414
Faure kleště na biopsii	450

Faure svorka na pobřišnici	128
Favaloro nůžky na cévy	45
Fergusson kleště na držení kostí	191
Fergusson nůžky chirurgické	34
Fergusson odsávačka	333
Fergusson svorka	130
Ferris-Smith pinzeta chirurgická	81
Ferris-Smith štípek	519
Ferris-Smith-Kerrison štípek na laminektomii	514, 515
Finochietto jehelec	302
Finochietto rozvěrač hrudní	238
Finochietto rozvěrač žeber	239
Finochietto svorka na ledviny	122
Finochietto-Baby rozvěrač žeber	239
Finsen rozvěrač	231
Fisch disektor	407
Fisch háček na nervy	532
Foerster kleště tamponové	204
Foerster-Ballenger kleště tamponové	203, 424, 434, 435
Fomon háček	395
Fomon nůž nosní	370
Fomon nůžky nosní	48
Fomon nůžky preparační	40
Fomon pilník nosní	421, 423
Fraenkel kleště na polypy	387, 391
Fraenkel koncovka	385
Franz rám břišní	245
Frazier disektor na mozkovou plenu	549
Frazier kanyla aspirační	334
Frazier odsávačka	334
Freer dláto nosní	425
Freer háček	395
Freer nůž na nosní přepážku	369
Freer páčidlo na nosní přepážku	408, 434
Freer páčidlo nosní	408, 433, 435
Fréza pro ORL	429, 430
Friedman kleště štípací na kosti	173
Fritsch hák břišní	220

## G

Gallagher pilník nosní	420
Garrett sonda cévní	323
Garrett sonda tracheální	323
Gellhorn kleště na biopsii	450
Gelpi rozvěrač	235
Gemini svorka preparační	119
Gerald pinzeta anatomická	80
Giertz-Stille kleště na žebra	183
Gillies pinzeta chirurgická	82, 92
Gil-Vernet hák páteřní	211
Glover svorka atraumatická	132, 153
Gluck kleště na žebra	182
Goelet hák	228
Goldman-Fox nůžky na dáseň	57
Gomel nůžky mikro	54
Good nůžky na mandle	48
Gosset rozvěrač břišní	241
Gourdet lžice děložní	481
Graefe hák	208
Graefe hák na duhovku	210
Graefe hák na operaci šilhání	210
Graefe pinzeta fixační	87
Graefe pinzeta oční	86, 433
Grave special zrcadlo	476
Grave zrcadlo poševní	473, 475
Gray svorka na žlučovod	123
Green-Armytage kleště	462
Gregory svorka atraumatická	151
Gregory-Soft bulldog svorka	133
Groningen háček na nervy	531
Gross smyčka drátěná	414
Gross-Maier kleště tamponové	202
Gutsch pilka rámová	284
Guyon dilatátor	341
Guyon svorka na ledviny	121

## H

Háček	348
Háček na galeu	528
Háček na nervy	530
Hajek-Claus štípek sfenoidální	381
Hajek-Koffler štípek na ploténky	520
Hajek-Kofler štípek sfenoidální	380
Hák	207, 208
Hák břišní	220
Hák na křídlo nosní	395, 433
Hák na nervy	532
Hák na rány	207, 433
Hák oční	210, 433
Hák ohebný	207
Hák pro plastiku	225
Hák rádiusový	248, 249
Hák resekcí	394
Hák tracheální	396, 435
Halle nůžky nosní	48
Halle páčidlo nosní	409
Halsey jehelec	301
Halsted-Mosquito svorka na cévy	103
Hardy nástroj pituitární	555, 556
Hardy-Fahlbusch nástroj pituitární	556
Harken svorka atraumatická	146
Harken svorka na cévy	167
Harms rozvěrač plotének	544
Harrington hák břišní	224
Hartmann háček ušní	394
Hartmann kleště na ušní polypy	390
Hartmann kleště nosní na polypy	391, 432, 433
Hartmann kleště štípací nosní	377
Hartmann kleště ušní štípací	374
Hartmann ladička	362
Hartmann svorka	103
Hartmann štípek na mandle	382
Hartmann zrcátko nosní	405, 432, 433, 435
Hartmann zrcátko ušní	401
Hartmann-French ladička	362
Hartmann-Halle zrcátko nosní	405
Hartmann-Noyes kleště ušní	390
Hartmann-Wullstein kleště miskové	390
Hartmann-Wullstein kleště na polypy	390
Heaney jehelec	295
Heaney svorka na hysterektomii	125, 446
Heaney-Ballantine svorka na hysterektomii	126, 447
Heath nůžky pro ligaturu	53
Hegar dilatátor hrdla děložního	493
Hegemann-Diethrich nůžky	44
Hegenbarth pinzeta svorkovací	317
Hegenbarth pinzeta šicí	317
Heifetz lopatka mozková	546
Heiss svorka na cévy	115
Heister rozvěrač úst	397
Henke páčidlo na mandle	410, 434
Henley rozvěrač	232
Henning kleště na sádrové obvazy	189
Hercules kleště štípací na drát	186
Herrick svorka na ledviny	121
Hey lopatka	534
Hey rozvěrač pro disektomii	534
Heymann kleště na nosní přepážku	379
Heymann nůžky nosní	48, 433
Heymann-Knight kleště nosní na polypy	391
Heywood-Smith kleště tamponové	201, 433, 434
Hirschmann anoskop s obturátorem	258
Hlava sací se zvětšováním	403
Hoer disektor na mozkovou plenu	549
Hoer svorka na cévy	510
Hohmann páčidlo	261
Hohmann páka kostní	264, 265
Horsley háček na nervy	529
Hösel jehelec	305
Hosobuchi nástroj pituitární	558
Hough nůžky nosní	48

House kyreta ušní	412
House odsávačka vyplachovací	333
Howarth páčidlo nosní	409
Hrazda	248, 249
Huber držadlo univerzální	384
Humby nůž transplantační	28
Hurd škrabka na mandle	411, 434, 435
Hurd škrabka nosní	411

## CH

Chaput svorka na cévy	100
Chevalier-Jackson kleště hrtanové	383

## I

Inge rozvěrač plotének	545
Iowa kleště děložní	460
Iowa odsávačka	332
Iowa trubička	494
Israel hák na rány	214
Itersen hák na průdušnici	396, 435
Ives-Fansler anoskop s obturátorem	258

## J

Jacobs kleště gynekologické	459
Jacobson jehelec mikro	307, 309
Jacobson nástroj mikro	503
Jaeger destička na víčkové operace	254
Jaeger hák na operaci šilhání	210
Janet stříkačka	347
Jansen kleště ušní štípací	380
Jansen rozvěrač	231
Jansen-Middleton kleště štípací nosní	378
Javid svorka atraumatická	155
Jehelec	295, 296, 297, 304
Jehelec mikro	310, 311
Jehelec neurochirurgický	311
Jehelec pro plastiku	311
Jehelník	355
Jehla	367
Jehla epilační	20
Jehla na mandle	331
Jehla na nosní přepážku	331
Jehla preparační	27
Jehla šicí pitevní	318
Jehla zaváděcí	329
Jennings rozvěrač úst	397
Jeweler pinzeta	92
Johns-Hopkins svorka na cévy	99
Jones svorka na prádlo	168
Joseph hák	207
Joseph nůž na nosní plastiku	370
Joseph páčidlo nosní	409
Joseph pilka nosní	419
Joseph pilník nosní	418
Jurasz kleště na polypy	387

## K

Kabel světlovodný	364
Kabierske zaprašovač	361
Kantrowitz svorka preparační	119
Katetr kovový	342
Kelly hák břišní	221
Kelly kleště na polypy	201
Kelly nůžky na fistuli	35, 443
Kelly proktoskop s obturátorem	258
Kelly sphinkteroskop s obturátorem	258
Kelly svorka na cévy	106, 113
Kelly-Rankin svorka na cévy	106
Kepák kleště na cervix	458
Kerrison štípák	381
Kerrison štípák na ploténky	521
Kevorkian kleště na biopsii	453
Kevorkian koncovka	455

Kevorkian kyreta sací pro biopsii	489
Kevorkian-Pacific kleště na biopsii	448
Kielland kleště porodní	463
Kielland-Luikart kleště porodní	463
Kilian kleště nosní na polypy	391
Killian nůžky na septum	372, 433
Killian páčidlo nosní	409
Killian zrcátko nosní	404, 433
Killian-Claus dláto nosní	425
Kilner jehelec	300
Kilner nůžky preparační	41
Kirschner jehla podvazovací	315
Kirschner rozvěrač břišní	244
Kladívko chirurgické	290, 433
Kladívko pitevní	290
Kladivo ortopedické	291
Kleinert-Kutz kleště štípací na kosti	177
Kleště mikro laryngeální	393
Kleště mikro miskové	386
Kleště na bronchoskopii	386
Kleště na držení kostí	192
Kleště na hadici	170
Kleště na hemoroidy	197
Kleště na kostní úlomky	191
Kleště na meziobratlové ploténky	513
Kleště na žebra	182
Kleště repoziční	193
Kleště štípací	181
Kleště štípací na drát	184-186
Kleště tamponové	202
Kleště úchopné na drát	190
Kleště ušní mikro	375
Kleště ušní úchopné	388, 389
Kleště zaváděcí pro svorky	526
Klíč	283
Klíč pro rozvěrač Caspar	538
Klička na výtěry	27
Klinikum Berlin svorka na trubice	170
Klinkenbergh-Loth nůžky neurochirurgické	46
Knight kleště na nosní přepážku	379
Koerte hák na rány	213
Kogan endozrcadlo	478
Kocher hák břišní	221
Kocher hák na rány	212, 216
Kocher pátradlo na strumu	431
Kocher svorka na cévy	104, 105, 107
Kocher-Delicate svorka na cévy	101
Kolibri pinzeta na duhovku	89
Koncovky gumové pro kleště Young	393
König jehla podvazovací	316
König nůžky na nehty	58
Koos nástroj mikro	502
Koutný pinzeta na duhovku	88
Krabice na nástroje	353
Krabička	354, 355, 433, 434, 435
Krabička sterilizační	354
Kraus nástroj mikro	502
Krause koncovka	385
Krayenbuehl háček na nervy	532
Kressner kleště na přepážku	392
Kristeller zrcadlo poševní	468
Kroenig držák jazyka	400
Kuehne pinzeta pro mikroskopická sklíčka	73
Kuhnt pinzeta na čočkové pouzdro	88
Kyreta aspirační	488
Kyreta děložní	482, 483, 486

## L

La Force adenotom	371
Ladička hliníková	363
Lahey kleště úchopné	388
Lahey svorka na žlučovod	122
Lambert pinzeta na chalazia	88
Lambert-Kay svorka atraumatická	145
Lambotte dláto neurochirurgické	561
Lampa čelní pro světlovodný kabel	364

Landau zrcadlo poševní	471	Markham-Meyerding rozvěrač	235
Landolt kleště na rozevirání zrcadla	547	Markwalder kleště štípací	180
Landolt nástroj pituitární	522, 557	Marquard kleště štípací	176
Landolt-Reulen nástroj pituitární	558	Maršík pinzeta na mandle	85, 434
Lane pinzeta chirurgická	79	Martin háček na nervy	530
Lane svorka na prádlo	168	Martin pelvimetr	441
Lang lžička oční	279	Martin sonda děložní	491
Lange kleště na polypy	387	Masing dláto nosní	428
Lange koncovka	385	Masing nůž nosní	370
Lange-Hohmann páka kostní	265	Masing páčidlo nosní	409
Langenbeck hák na rány	215, 435	Masing pilník nosní	421
Langenbeck jehelec	305	Masson jehelec	302
Langenbeck kyreta ušní	413	Mathieu hák	228
Langenbeck nůž amputační	25	Mathieu jehelec	296, 303
Langenbeck páčidlo	261	Mathieu-Ryder jehelec	304
Langenbeck škrabka	269	Mayfield kleště štípací na kosti	176
Langenbeck-Delicate jehelec	305	Mayo držák jazyka	400, 433
Langenbeck-Ryder jehelec	305	Mayo nůžky	62
Lawrence svorka preparační	118	Mayo nůžky preparační	39, 59, 68
Lebsche nástroj na sternum	289	Mayo spona na nástroje	351
Lees svorka atraumatická	148	Mayo-Adams rozvěrač	236
Leland-Jones svorka atraumatická	138	Mayo-Hegar jehelec	295, 298, 433
Lempert kyreta	412	Mayo-Hegar-Delicate jehelec	295
Lempert páčka ušní	408	Mayo-Robson svorka na střeva	127
Lempert škrabka	411	Mayo-Stille nůžky	63, 68
Leriche svorka na cévy	104	Mayo-Stille nůžky preparační	39, 59, 433, 435
Lewis pilník nosní	420, 423	McGee háček	367
Lexer nůžky	67	McGee kleště ušní štípací	375
Lexer nůžky preparační	41	McIndoe nůžky na chrupavku	47
Lexer-Baby nůžky preparační	40	McIndoe pinzeta anatomická	78
List pilky	284	McIvor rozvěrač úst	398, 432, 434
List pilky pro tvrdou sádru	283	McKenty páčidlo nosní	409
Lister kleště tamponové	199	McKenzie kleště zaváděcí	527
Lister nůžky na obvazy	56, 67	McLean kleště porodní	463
Lister-Excentric nůžky na obvazy	56	Meeker svorka na cévy	112
Liston kleště štípací na kosti	179, 180	Menghini jehla na biopsii	330
Littauer nůžky pro ligaturu	53	Měřítka	16
Littauer-Liston kleště štípací	181	Metzenbaum jehelec	304
Löbker kleště na jazyk	393	Metzenbaum nůžky	63, 64, 68, 69
Lopatka břišní	253	Metzenbaum nůžky preparační	37, 60
Lopatka mozková	546	Metzenbaum-Delicate nůžky	65, 66, 69, 70
Lopatka na jazyk	400	Metzenbaum-Delicate nůžky preparační	38, 60
Lopatka na mast s výřezem	254	Metzenbaum-Nelson nůžky preparační	37, 60
Lopatka pro O'Sullivan-O'Connor	479	Meyhöfer lžička na chalazia	279
Lopez-Reinke páčidlo na mandle	410	Micro-Adson pinzeta anatomická	78
Lorenz nůžky na obvazy	55	Micro-Adson pinzeta chirurgická	78
Lorna svorka na prádlo	169	Micro-bulldog svorka na cévy	98
Love háček na nervy	530	Micro-Mosquito svorka na cévy	103
Love modif. háček na nervy	530	Microvascular jehelec	299
Love-Gruenwald kleště	516	Middeldorpf hák na rány	218
Lower svorka na ledviny	122	Michel pinzeta šicí	317
Lubet-Barbon kleště nosní na polypy	391	Michel svorka šicí	317
Luc kleště na nosní přepážku	379	Mikro nůžky	506
Lucae jehla paracentézní	365	Mikulicz hák břišní	224
Lucae ladička	362	Mikulicz svorka na pobřišnici	128
Lucae páčka ušní	407	Milan kyreta na biopsii	488
Lucae pátradlo háčkové	407	Miller-Colburn pilník nosní	422
Lucae pinzeta ušní anatomická	85	Millesi nůžky mikro	505
Luer kleště štípací na kosti	173–176	Milligan disektor na mozkovou plenu	550
Luer-Koerte lžička na žlučové kameny	278	Mini-Friedman kleště štípací na kosti	173
Luer-Lock kanyla sací a proplachovací	334	Mini-Hohmann páka kostní	263
Luer-Stille kleště štípací na kosti	176	Mini-Langenbeck hák	209, 435
Luethy-Beck jehelec	305	Mini-Townsend koncovka	455
Lukens hák na průdušnici	396	Miska	351, 432, 433, 434, 435
Lžíce pro zrcadlo Scherback	470	Miskimon rozvěrač	233
Lžička	275	Mixter svorka preparační	117
Lžička děložní	480	Mixter-O'Shaughnessy svorka preparační	117
Lžička na páteř	280	Mod. Bonn nůžky	34
Lžička ortopedická	280	Mod. Wien zrcátko nosní	405
Lžička trepanační	275	Moeltgen goniometr	16
		Mollison rozvěrač	233
		Molt rozvěrač úst	397
		Moritz-Schmidt držák jazyka	399
		Morris-De Bakey svorka atraumatická	150
		Mosquito-Halsted svorka na cévy	102, 433, 435
		Museux kleště gynekologické	459
		Myles kleště štípací nosní	377

## M

Magill kanyla aspirační	332
Magill kleště na zavádění endotracheálních rourek	190
Maltz pilník nosní	420
Manometer pro Schulzte salpingograph	441



## N

Nabatoff soubor na křečové žíly	323
Naběračka pro anatomii	15
Naegele kleště porodní	462
Naegele perforátor	465
Nagel nůžky mikro	504
Nálevka	351
Naražeč kostních štěpů	560
Nástroj mikro	511, 525, 552, 553
Nástroj na cizí tělesa v rohovce	23
Nástroj pituitární	522
Nástroj pro přenos IUD	465
Negus svorka na žlučovdu	123
Neivert dláto nosní	428
Nelson pinzeta úchopná	82
New Orleans jehelec	300
New port páka poševní	479
Nicola nástroj mikro	525
Nicola nástroj pituitární	555
Northbent nůžky pro ligaturu	53
Nott zrcadlo poševní	473
Notto kleště na polypy	200
Novak sací kyreta na biopsii	489
Noyes nůžky na duhovku	51
Nůž háčkový	348
Nůž klapův	24
Nůž na flegmonu	370
Nůž na meniskus	27
Nůž na varixy	24
Nůž pitevní	26
Nůž pro Otis uretrotom	343
Nůž reseční	22
Nůž trojúhelníkový	348
Nůžky anatomické	47
Nůžky chirurgické	32, 33, 59
Nůžky mikro	53, 54, 372, 504, 505
Nůžky na dáseň	57
Nůžky na duhovku	61, 67, 70
Nůžky na incisi	31
Nůžky na kosti pro anatomii	31
Nůžky na měkké obvazy	55
Nůžky na nehtovou kůžičku	58
Nůžky na nehty	58
Nůžky na sádrové obvazy	56
Nůžky na střeva	47
Nůžky na stříhání vlasů	55
Nůžky oční	49–51
Nůžky preparační	40–42, 433, 435

## O

O'Sullivan-O'Connor rozvěrač břišní	243
O'Sullivan-O'Connor rozvěrač	479
Oehler pinzeta chirurgická	92
Ochsner svorka atraumatická	151
Ochsner-Kocher svorka na cévy	109, 432, 434, 435
Okonek nástroj mikro	533
O-kroužek gumový k aplikátoru	349
Oldberg štípací na laminektomii	518
Olivecrona lopatka mozková	546
Olivecrona-Toennis kleště zaváděcí	527
Olivercrona disektor na mozkovou plenu	550
Olivercrona pilka drátěná	559
Ollier škrabka	270, 271
Olsen-Hegar jehelec/nůžky	295, 303
Otis uretrotom mod. Keitzer	343
Ouinke jehla na biopsii	330
Overholt svorka na cévy	111
Overholt svorka na lobektomii	110
Overholt-Geissendoerfer svorka na cévy	110
Overholt-Mixter svorka na cévy	114

## P

Páčidlo	261, 262
Páčidlo na nosní přepážku	408

Páčidlo prohnuté	262
Páčka ušní	407
Páka kostní	263
Páka na lebku	289
Parametrium nůžky	62
Parametrium svorka	129
Parker hák	227, 228
Parker-Langenbeck hák	228
Pátradlo děložní	492
Pátradlo nosní	431
Pátradlo paličkové	321
Pátradlo paličkové s dlátkem	321
Pátradlo ušní	431
Pátradlo žlábkové	321
Payr jehla podvazovací	316
Peau svorka na cévy	101, 104, 107
Peau-Delicate svorka na cévy	101
Pederson zrcadlo	477
Pederson zrcadlo poševní	473
Peers svorka na prádlo	169
Peet pinzeta na třísky	84
Pelkmann kleště tamponové	201
Penfield disektor na mozkovou plenu	551
Percy talíř amputační	250
Phaneuf svorka na hysterektomii	126, 447
Pilník	285
Pinzeta anatomická	74–76, 85, 92, 434, 435
Pinzeta bipolární	434, 435
Pinzeta cévní atraumatická	90
Pinzeta enukleační	87
Pinzeta epilační	73
Pinzeta chirurgická	74, 75, 77, 433, 435
Pinzeta mikro	507, 508
Pinzeta na columellu	433
Pinzeta na duhovku anatomická	87
Pinzeta na duhovku chirurgická	87
Pinzeta na keratoplastiku	89
Pinzeta na plastiku šicí	73
Pinzeta na rohovku	89
Pinzeta na řasy	89
Pinzeta na třísky	84, 433
Pinzeta pro výměnu lopatek	537
Pinzeta šicí	73, 83, 89, 508
Pinzeta technická	84
Piper kleště porodní	462
Plattfuss štípací na ploténky	521
Plester nůž ušní	368
Plester odsávačka	334
Plester rozvěrač	236
Politzer balonek profukovací	361
Politzer jehla paracentézní	365
Politzer nůž na furunkl	369
Politzer přechodka	361
Politzer špička	361
Politzer zrcátko ušní	401
Poole odsávačka	336
Potts svorka atraumatická	136
Potts-De Martel nůžky na cévy	45
Potts-Smith jehelec mikro	307
Potts-Smith nůžky	43, 65
Potts-Smith pinzeta anatomická	80
Potts-Smith pinzeta chirurgická	80
Pouzdro vodící	348
Pozzi kleště gynekologické	456
Pratt kleště gynekologické	457
Pratt svorka na hemeroidy	130
Pratt zrcadlo rektální	257
Pravaz jehla injekční	329
Presbyterian svorka na trubice	170
Prince nůžky na mandle	48, 432, 434
Providence-Hospital svorka na cévy	104
Přečechtěl škrabka nosní	411, 434
Putti rašple	285

## Q

Quinby nůžky na dáseň	57
-----------------------	----

## R

Rabiner kladívko	13
Raimondi svorka na cévy	510
Rám pro O'Sullivan-O'Connor	479
Ramathibodi hák	495
Ramathibodi manipulátor děložní	495
Rameno háku	248, 249
Rameno háku dlouhé	248, 249
Ramplé kleště tamponové	204
Randal kyreta sací pro biopsii	489
Randall kleště na ledvinové kameny	198
Ray nástroj pituitární	555
Recamier lžička děložní	480
Recamier/Sims kyreta	484
Rehn nůž transplantační	28
Reiner nůž na sádrové obvazy	25
Retraktor pro discektomii	535
Reverdin jehla	313
Reverdin lopatka břišní	253
Reynolds nůžky preparační	42, 61
Ricard rozvěrač břišní	247
Richardson hák na rány	219
Richardson-Eastman hák na rány	219
Richter nůžky chirurgické	31
Roberts svorka na cévy	115
Roeder svorka na prádlo	169
Rochester-Carmal svorka na cévy	113
Rochester-Ochsner svorka na cévy	105
Rochester-Pean svorka na cévy	108, 432–435
Rosen jehla	366, 367, 433
Rosen nůž ušní	368
Rosen odsávačka	332
Rosenberg koncovka	385
Roser-König rozvěrač úst	397
Roux hák	227
Rozvěrač	231, 542
Rozvěrač břišní	249
Rozvěrač břišní Rochard	249
Rozvěrač břišní řetězový	247
Rozvěrač břišní univerzální	248
Rozvěrač břišní žeberního oblouku	249
Rozvěrač pro laminektomii	240
Rozvěrač ran	237
Rozvěrač víček kojenecký	231
Rozvěrač víček mikro	231
Rubin dláto	427
Rumel svorka preparační	116
Ruskin kleště štípací	178
Ruskin kleště štípací na kosti	174
Russ. Modell pinzeta chirurgická	82
Ryder/French-Eye jehelec oční	299

## S

Saenger kleště děložní	460
Sachs disektor na mozkovou plenu	549
Sachs háček na nervy	529
Saigres kleště gynekologické	458
Samii nástroj mikro	554
Santulli bulldog svorka atraumatická	131
Sanvenero nůžky preparační	42
Sarot jehelec	302
Sarot svorka na cévy	115
Satinsky nůžky neurochirurgické	46
Satinsky svorka atraumatická	144
Satinsky svorka cévní	167
Sauerbruch kleště na žebra	182
Sauerbruch škrabka	271
Sauerbruch-Frey kleště na žebra	183
Saunders nástroj pro přenos IUD	492
Scoville háček na nervy	529
Scoville lopatka	540
Scoville-Haverfield rozvěrač	540
Scoville-Richter rozvěrač	541
Segond nůž na myomy	442
Seiffert koncovka	385

Selverstone kleště na ploténky	517
Semb uvolňovač	120
Semken pinzeta anatomická	78, 92
Semken pinzeta chirurgická	78
Semm rozvěrač břišní	244
Semm zrcadlo poševní	474
Senning (Swed. Mod) jehelec	300
Senn-Miller hák páteřní	211
Seutin nůžky na sádrové obvazy	56
Sewall kyreta nosní	414
Seyffert zrcadlo poševní	474
Shambaugh jehla	366
Shapleigh kyreta ušní	413
Shea kyreta ušní	412
Sheehan dláto	427
Schaedel svorka na prádlo	168
Schede lžička kostní	276
Scheinmann grid koncovka	385
Scheinmann koncovka misková	385
Scherback zrcadlo poševní	470
Schink nůž transplantační	28
Schlesinger kleště na ploténky	517
Schmeden kleště štípací nosní	377
Schmieden-Payr jehla podvazovací	316
Schmieden-Taylor nůžky neurochirurgické	45
Schmidt-Sawtell svorka na cévy	113
Schröder kleště	456, 457
Schröder kleště gynekologické	457
Schubert kleště na biopsii	450, 451
Schuknecht nůž ušní	368
Schultze set pro hystero-salpingografii	441
Schumacher kleště na biopsii	453
Schumacher koncovka	385
Schumacher-Van Doren kleště na biopsii	452
Schwartz aplikátor svorek micro-bulldog	98
Schwartzé háček ušní	394
Schwartzé jehla paracentézní	365
Siebolt nůžky děložní	36, 444
Siegle otoskop	403
Siegle zrcátko ušní	403
Silver dláto nosní	428
Simon hák na fistuli	467
Simon/Schröder lžice děložní	481
Simplex držák na tváře	399
Simpson kleště porodní	463
Simpson-Braun kleště porodní	463
Sims nůžky gynekologické	36, 444
Sims pátradlo děložní	492
Sims sonda děložní	491
Sims Swed. model sonda děložní	491
Sims zrcadlo poševní	469
Sims zrcadlo rektální	257
Sims/Recamier kyreta	485
Sims-Special sonda děložní	491
Singley-Tuttle pinzeta	82
Síto sterilizační	353
Skalpel s hranatým držadlem	21, 22, 442
Smellie hák dekapitační a porodnický	466
Smellie perforátor	465
Smith (mod. USA) nůžky na obvazy	55
Smith-Peterson kleště štípací	178
Smithwick háček na nervy	531
Smyčka drátěná	417, 434
Snellen smyčka drátěná	414
Somer kleště děložní	460
Sonda kovová	323
Sonda plastová	323
Sonda urologická s olivkami	324
Spencer nůžky pro ligaturu	53
Spojka kyrety aspirační	488
Spratt lžička kostní	277
Spurling kleště	516
St.Clair-Thompson kyreta na mandle	416
Standard držák jazyka	400
Stellbrink kleště štípací na kosti	173
Sternum jehelec	306
Stevens nůžky oční	50, 61, 70

Stieglitz pinzeta na třísky	84
Stille dláto	292
Stille kleště na sádrové obvazy	189
Stille svorka na ledviny	121
Stille-Barraya pinzeta chirurgická	81, 434
Stille-Ruskin kleště štípací	177
Strully nůžky neurochirurgické	45
Strümpel kleště na ušní polypy	374
Strümpel kleště ušní štípací	374
Struycken kleště štípací nosní	377, 378
Stříkačka	347
Subramanian svorka atraumatická	166
Subramanian-miniature svorka atraumatická	166
Svorka	526
Svorka atraumatická	134, 153, 162–164
Svorka na trubice	170
Svorka preparační	510
Svorka pro svorky bulldog	99

## Š

Škrabka exartikulační	271
Škrabka na operaci slzného vaku	272
Škrabka na rohovku	272
Škrabka	418

## T

Tabb nůž ušní	368
Tác	352, 432
Takahashi kleště štípací nosní	378
Tarnier basiotribe	464
Taylor kladívko reflexní	13
Taylor lopatka	540
Taylor páka kostní	266
Taylor pinzeta anatomická	79, 433
Taylor pinzeta chirurgická	79
Teale kleště gynekologické	459
Thoms-Gaylor kleště na biopsii	451
Thorek nůžky preparační	40
Tieck-Halle zrcátko nosní	405
Tischler držadlo	455
Tischler kleště na biopsii	449, 451
Tischler koncovka	455
Tischler-Kevorkian kleště na biopsii	448
Tischler-Morgan kleště na biopsii	449
Tobold držák jazyka	399
Toennis disektor na mozkovou plenu	548
Toennis nůžky neurochirurgické	45
Toennis svorka preparační	119
Toennis-Adson-Delicate nůžky	67
Tohoku-Japan svorka na prádlo	169
Toulec na kleště	350
Toulec na pinzety	350
Toynbee zrcátko ušní	401
Troeltsch pinzeta nosní	85, 432
Troeltsch pinzeta ušní	85
Troemner kladívko	14
Trousseau rozvěrač trachey	398
Trubička gumová s balónkem pro Siegle	403
Třmen háku	248, 249
Třmen spojovací	248, 249
Třmen základny	248, 249
Tuffier lopatka na ledviny	254
Tuffier svorka na cévy	100
Tuohy jehla na biopsii	330
Tyč spojovací	248, 249
Tyčinka retrakční atraumatická	494

## U

Ulrich kleště na polypy	199
Universal nůžky na drát	67
Universal nůžky na obvazy	55

## V

Valleix sonda děložní	491
Van Buren sonda urologická	341
Van Doren kleště na biopsii	452
Vannas nůžky mikro	505
Verbrugge kleště repoziční	195
Virchow nůž pitevní na mozek	26
Virchow nůž na chrupavku	26
Volkman hák na rány	212, 213
Volkman lžička	278
Volkman lžička kostní	276

## W

Wagener háček ušní	394
Wagner nůžky	34
Waldmann nůžky pro episiotomii	35, 443
Wallich lžice děložní	481
Walter dláto nosní	427
Walton nůžky	34
Walton rozvěrač ran páteřní	237
Walton-Liston kleště štípací	181
Wangensteen jehelec	302
Wangensteen pinzeta anatomická	81
Wangensteen pinzeta chirurgická	93
Weber svorka atraumatická	147
Webster jehelec	301
Weil-Blakesley kleště štípací nosní	376, 432, 433
Weingärtner kleště ušní	390
Weitlaner rozvěrač	232, 435
Wertheim nůžky břišní	35
Wertheim svorka na hysterektomii	124, 125, 445, 446
Wertheim-Cullen svorka na hysterektomii	126, 447
West dláto nosní	424, 425
Westcott nůžky na rohovku	52
Westmacott kleště nosní na polypy	391
Whitehead rozvěrač úst	397
Wieder držák na jazyk	399
Wiener pilník nosní	421
Wigmore pilka na sádrové obvazy	283
Williger páčidlo	261
Williger škrabka	269
Winter kleště potratové	461
Wittner kleště na biopsii	453
Wolff kleště na sádrové obvazy	189
Wrigley kleště porodní	462
Wullstein kleště úchopné ušní	388
Wullstein nůž ušní	368
Wullstein nůžky ušní	373
Wullstein rozvěrač	233

## Y

Yankauer odsávačka	336
Yasargil nástroj mikro	501, 503
Yasargil odsávačka	335
Yasargil pinzeta na nádory	83
Young hák na prostatu	226
Young kleště na jazyk	393

## Z

Základna rozvěrače	248, 249
Zatloukač úzký	560
Zaufal háček ušní	394
Zaufal-Jansen kleště štípací na kosti	177
Zavaděč drátěných pilek	559
Zavaděč	323
Zavaděč pouzdra vodičů	348
Závaží pro zrcadlo Scherback	470
Zenker svorka preparační	116
Zielke štípací meziobratlový	512
Zöllner s kanylou	332
Zrcadlo čelní	364
Zrcátko hrtnové	406



## A

Abdominal retractor	220, 249
Abdominal spatula	253
Adapter instrument side	364
Adapter projector side	364
Adlerkreutz tissue forceps	81
Adson artery forceps	112
Adson aspirating tube	334
Adson dressing forceps	78
Adson forceps	93
Adson retractor	233, 237
Adson tissue forceps	78
Adson-Brown tissue forceps	78
Agnew paracentesis needle	365
Alexander biopsy forceps	453
Allis intestinal forceps	197
Allis tissue forceps	100
Allison lung spatula	253
Alm retractor	231
Anatomical forceps	85
Anderson-Adson retractor	233
Anderson-Neivert chisel	428
Andrew-Pynchon suction tube	336, 432, 433, 434, 435
Applying forceps for clips	526
Artery forceps atraumatic jaws	134
Asch septumening forceps	392
Aspirating curette	488
Atrauma forceps	153, 162–164
Atraumatic retracting rod	494
Aufricht (Walter) hook	394
Aufricht hook	394
Aufricht nasal rasp	420
Aural probe	431
Auvarad vaginal speculum	471

## B

Babcock tissue seizing forceps	98
Babinsky percussion hammer	13
Baby-Adson artery forceps	112, 435
Baby-Crile-Wood needle holder	301, 435
Baby-Mikulicz peritoneal clamp-forceps	128
Baby-Mixer dissecting forceps	117
Baby-Satinsky vena-ceva forceps	167
Baby-Tischler biopsy forceps	449
Backhaus forceps	168
Backhaus paper forceps	168
Backhaus towel forceps	169, 432, 434
Backhaus-Clip towel forceps	169
Balfour abdominal retractor	242
Balginsky laryngeal knife	370
Bainbridge artery forceps	113
Bainbridge atrauma forceps	138
Bakeš gall duct probe	322
Balfour abdominal retractor	242
Balfour-Baby abdominal retractor	242
Ballenger knife for septum	369, 433
Ballenger nasal chisel	425
Barbara hooklet	366
Barbara needle	366, 367
Barnhill adenoid curette	416
Baron suction tube	333
Barraquer eye scissors	51
Barraquer micro needle holder	308, 312
Barrett gynaecological forceps	456
Bartl nail extraction forceps	191
Base clamp (tube-to-tube clamp)	248, 249
Beacham amniotome	466
Beck atrauma forceps	153, 159

Beckmann adenoid curette	415, 432
Beckmann retractor	234
Beckmann-Eaton retractor	234
Beer cilia forceps	89
Beeson plaster cast spreader	189
Bellucci micro instrument	524
Bellucci scissors	373
Bengolea artery forceps	114
Bensaude anoscope with obturator	258
Berger biopsy forceps	454
Berliner neurological reflex hammer	14
Bernhard towel forceps	168
Berry wire twisting forceps	306
Bethune rib forceps	182
Beyar bone rongeur	177
Biemer nerve hook	532
Bier biopsy needle	330
Billeau loop	414
Bipolar forceps	434, 435
Blade	246
Blade for retractor O'Sullivan-O'Connor	479
Blade for transplantation knife	28
Blade only for Scherback speculum	470
Blake uterine curette	487
Blascovics strabismus forceps	88
Blount bone elevator	266
Blount meniscus hook	225
Blumenthal bone rongeur	173
Böhler bone rongeur	176
Bone elevator	263
Bone file	285
Bone forceps	192
Bone graft driver	560
Bone rongeur	181
Bone scissors	31
Bonney tissue forceps	82, 93
Bowl	351, 432, 433, 434, 435
Bowmann eye probe	325
Box	354
Box for instruments	353
Box round	355, 433, 434, 435
Boynton eye needle holder	296, 305
Bozemann sponge holding forceps	200
Brain spatula	546
Braun cranioclast	464
Braun decapitation hook	466
Braun-Stadler episiotomy scissors	35, 443
Breisky vaginal speculum	471
Bridge dissecting forceps	118
Bronchoscopy forceps	386
Brown tissue forceps	80
Bruenings ear speculum	403
Bruenings knife	370
Bruenings otoscope	403
Bruenings rubber bulb only for otoscope	403
Bruenings septum forceps	379, 432
Bruenings tip	384, 385
Bruenings tongue spatula	400, 434
Bruenings tonsil snare	417, 434
Bruennings tongue depressor	400
Brunner ligature needle	315
Brunner retractor	217
Brunner rib forceps	183
Bruns bone curette	277
Bruns plaster-of-paris shears	56
Buck ear curette	413
Buck percussion hammer	13
Buchwald tongue spatula	400
Bumm uterine curette	487
Burke cervical biopsy forceps	448

# C

Cable flexible	323
Caspar blade	536, 537–539
Caspar cervical retractor	536, 538
Caspar hook	538
Caspar micro instrument	533, 553, 554
Caspar retractor	539
Caspar rongeur	517
Castroviejo corneal forceps	89
Castroviejo delicate eye scissors	52
Castroviejo iris scissors	52
Castroviejo micro-needle holder	307, 309
Castroviejo needle holder	306, 307
Catlin amputating knife	25
Chain abdominal retractor	247
Chaput artery forceps	100
Chevalier-Jackson laryngeal forceps	383
Cilia forceps	89
Cinelli osteotome	427
Cleveland bone rongeur	173, 181
Cleveland-Gardner bone rongeur	180
Clip	526
Cloward lamina spreader	543, 544
Cloward modif. retractor	542
Cloward rongeur	518
Cloward spoon	280
Cloward-modif. blade	542
Coakley nasal curette	414
Collin abdominal retractor	246
Collin amputating knife	25
Collin clip forceps	317
Collin dressing forceps	200
Collin dynamometer	16
Collin scalpel handle	19
Collin tongue holding forceps	393
Collin tumor forceps	197
Collin uterine curette	487
Collin vaginal speculum	473
Collin-Baby abdominal retractor	246
Collin-Duval grasping forceps	81
Columella forceps	433
Conductor for wire saws	559
Cone retractor	234
Connecting adaptor	488
Connecting clamp	248, 249
Connecting horizontal rod	248, 249
Converse chisel	428
Converse nasal knife	370
Converse nasal rasp	421
Cooley atrauma forceps	155–158, 161
Cooley-Derra atrauma forceps	159
Cordes tip	385
Corneal scarifier	272
Corneal suturing forceps	89
Coryllos rib forceps	182
Costal arch abdominal retractor	249
Cottle cartilage crucher	392, 433
Cottle hook	395
Cottle chisel	426
Cottle Kazanjian bone rongeur	180
Cottle knife	370
Cottle nasal elevator	408, 409, 433
Cottle nasal rasp	420, 423
Cottle nasal scissors	48
Cottle osteotome	426, 547
Cottle-Neivert hook	395
Crafoord artery forceps	115
Crafoord lobectomy scissors	47
Crafoord-Sellers bronchus forceps	114
Craig septum forceps	379
Craig-Domnick septum forceps	379
Crile artery forceps	106
Crile needle holder	296, 304
Crile-Rankin artery forceps	106
Crile-Wood needle holder	301
Crura-Nipper micro ear forceps	375

Cusco vaginal speculum	472, 477
Cusco-Suisse vaginal speculum	472
Cusco-Virgin vaginal speculum	472
Cushing delicate hook	208, 209
Cushing dressing forceps	79
Cushing forceps	93
Cushing rongeur	516
Cushing tissue forceps	79
Cushing-Landolt speculum for hypophysectomy	547
Cushing-Taylor forceps	93
Cuticle scissors	58

# D

Dahlgreen cranial rongeur forceps	523
Dale atrauma forceps	152
Dandy artery forceps	101
Dandy nerve hook	531
Dardik atrauma forceps	160
Darling retractor	235
Dartigues uterine elevating forceps	460
Daviel eye spoon with spatula	279
Davis dura dissector	548
De Bakey artery scissors	45
De Bakey atrauma bulldog clamp	131
De Bakey atrauma forceps	91, 93, 137, 139–143, 145, 149, 154, 165
De Bakey needle holder	298
De Bakey scissors	65
De Bakey suction tube	336
De Bakey vascular scissors	43
De Bakey-Bahnsen atrauma forceps	145
De Bakey-Carotis bulldog clamp	133
De Bakey-Mosquito atrauma forceps	135
De Bakey-Pean atrauma forceps	135
De Bakey-Rankin atrauma forceps	135
De Bakey-Satinsky bulldog clamp	133
De Lee obstetrical forceps	462
De Vilbiss cranial rongeur forceps	523
Deaver operating scissors	34
Deaver retractor	222, 223
Dejérine percussion hammer	14
Dejérine percussion hammer with needle	14
Delicate hook	207, 208, 433
Denhart mouth retractor	397
Dennis-Browne abdominal retractor	243
Depilation forceps	73
Depilation needle	20
Derf needle holder	300
Derra atrauma forceps	152
Deschamps ligature needle	314, 435
Desjardines gall duct probe	322
Desjardins gall duct clamp	123
Desmarres delicate hook	209
Desmarres chalazion forceps	88
Diamond bur	430
Diamond needle holder	311
Dieffenbach artery forceps	99
Dieffenbach bulldog clamps	99
Dieffenbach operating knife	23
Dieter micro ear forceps	375
Diethrich micro forceps	509
Diethrich micro-needle holder	307
Dietrich atrauma forceps	151
Dissectomy retractor	535
Dissecting forceps	510
Dissecting needle	27
Dissecting scissors	40–42, 47, 433, 435
Dissection micro scissors	54
Dittel bougie urethral	340
Dittel urethral sound	340
Douay biopsy forceps	454
Double foreign body instrument	23
Doyen abdominal scissors	35
Doyen myoma instrument	490
Doyen rib raspatory	270
Doyen towel forceps	168
Doyen vaginal speculum	470

Dressing forceps	74–76, 92, 434, 435
Dubois cephalotomy scissors	36, 444
Duckbill ear forceps	390
Dura dissector	548, 550
Durante tissue forceps	82
Duval lung grasping forceps	196
Duval tissue forceps	82

## E

Ear elevator	407
Ear forceps	388, 389
Echlin bone rongeur	177
Eicken wash tube	334
Eicken-Killian wash tube	335
Elevator	261, 262
Elevator wide	262
Elschnig fixation forceps	87
Emmet fistula hook	467
Endolaryngeal micro scissors	372
Engel plaster-of-paris saw	283
Engl. Modell towel forceps	168
Enterotomy scissors	47
Enucleation forceps	87
Eppendorf biopsy tip	455
Eppendorpf biopsy forceps	454
Esmarch bandage scissors	56
Eufrate Pasque needle holder	299
Extractor	495
Eye dilator	325
Eye hook	210, 433
Eye scissors	49, 50
Eye scissors for cornea	51

## F

Fahlbusch micro instrument	524
Fahlbusch pituitary instrument	557
Farabeuf raspatory	269
Farabeuf reposition forceps	194
Farabeuf retractor	227
Farabeuf-Lambotte reposition forceps	194
Farrior ear speculum	402
Faulkner nasal curette	414
Faure biopsy forceps	450
Faure peritoneal clamp-forceps	128
Favaloro artery scissors	45
Fergusson angiotribe clamp	130
Fergusson bone holding forceps	191
Fergusson operating scissors	34
Fergusson suction tube	333
Ferris-Smith laminectomy punch	519
Ferris-Smith rongeur	519
Ferris-Smith tissue forceps	81
Ferris-Smith-Kerrison laminectomy punch	514, 515
Finochietto kidney pedicle forceps	122
Finochietto needle holder	302
Finochietto pectoral retractor	238
Finochietto rib spreader	239
Finochietto-Baby rib spreader	239
Finsen retractor	231
Fisch dissector	407
Fisch nerve hook	532
Flat nose pliers	190
Foerster sponge holding forceps	204
Foerster-Ballenger forceps	203, 434, 435
Fomon delicate hook	395
Fomon dissecting scissors	40
Fomon knife	370
Fomon nasal rasp	421, 423
Fomon nasal scissors	48
Forceps for changing blades	537
Forceps micro	386
Forceps quiver	350
Fraenkel polypus forceps	387, 391
Fraenkel tip	385
Frame for retractor O'Sullivan-O'Connor	479

Franz abdominal retractor	245
Franz retractor	245
Frazier aspirating cannula	334
Frazier dura dissector	549
Frazier suction tube	334
Freer delicate hook	395
Freer nasal elevator	408, 433, 435
Freer nasal chisel	425
Freer septum elevator	408, 434
Freer septum knife	369
Friedman bone rongeur	173
Fritsch abdominal retractor	220
Fritsch retractor	220
Funnel	351

## G

Galea hook	528
Gallagher nasal rasp	420
Garrett tracheal dilatator	323
Garrett vascular dilatator	323
Geelhorn biopsy forceps	450
Gelpi retractor	235
Gemini dissecting and ligature forceps	119
Gerald dressing forceps	80
Gerald tissue forceps	80
Giertz-Stille forceps for ribs	183
Gillies tissue forceps	82, 92
Gil-Vernet spinal hook	211
Glover atrauma clamp	132
Glover atrauma forceps	153
Gluck pulling forceps for ribs	182
Goelet retractor	228
Goldman-Fox gum scissors	57
Gomel dissection micro scissors	54
Good tonsil scissors	48
Gosset abdominal retractor	241
Gouge	292, 561
Gourdet uterine scoop	481
Graefe delicate hook	208
Graefe eye forceps	86, 433
Graefe fixation forceps	87
Graefe iris hook	210
Graefe strabismus hook	210
Grave special vaginal speculum	476
Grave vaginal speculum	473, 475
Gray gall duct clamp	123
Green-Armytage forceps	462
Gregory atrauma forceps	151
Gregory-Soft bulldog clamp	133
Groningen nerve hook	531
Gross loop	414
Gross-Maier sponge holding forceps	202
Guide for sleeve	348
Guide needle	329
Guide sleeve	348
Gum O-ring for applicator	349
Gum scissors	57
Gutsch bone saw	284
Guyon dilating bougie	341
Guyon kidney pedicle clamp-forceps	121

## H

Haemorrhoids forceps	197
Haemorrhoidal ligator	349
Hair scissors	55
Hajek-Claus sphenoid punch	381
Hajek-Kofler laminectomy punches	520
Hajek-Kofler punches	520
Hajek-Kofler sphenoid punch	380
Halle nasal elevator	409
Halle nasal scissors	48
Halsey needle holder	301
Halsted-Mosquito artery forceps	103
Handle for laryngeal mirrors	406
Handle only	323

Handle only for Scherback speculum	470
Hardy pituitary instrument	555, 556
Hardy-Fahlbusch pituitary instrument	556
Harken atrauma forceps	146
Harken vena-ceva forceps	167
Harms lamina spreader	544
Harrington retractor	224
Hartmann ear forceps	374
Hartmann ear hook	394
Hartmann ear polypus forceps	390
Hartmann ear speculum	401
Hartmann forceps	103
Hartmann nasal cutting forceps	377
Hartmann nasal polypus forceps	391, 432, 433
Hartmann nasal speculum	405, 432, 433, 435
Hartmann polypus forceps	390
Hartmann tonsil punch	382
Hartmann tuning fork	362
Hartmann-French tuning fork	362
Hartmann-Halle nasal speculum	405
Hartmann-Noyes ear forceps	390
Hartmann-Wullstein polypus forceps	390
Head mirror	364
Headlamp fiber optic	364
Heaney hysterectomy clamp-forceps	125, 446
Heaney needle holder	295
Heaney-Ballantine clamp-forceps	126, 447
Heath ligature scissors	53
Hegar uterine dilator	493
Hegemann-Diethrich vascular scissors	44
Hegenbarth forceps for clips	317
Hegenbarth suture forceps	317
Heifetz brain spatula	546
Heiss artery forceps	115
Heister mouth retractor	397
Hemorrhoidal applicator	349
Henke dissector	410, 434
Henley exchangeable blade	232
Henley retractor	232
Henning plaster cast spreader	189
Hercules wire cutting forceps	186
Herrick kidney pedicle clamp-forceps	121
Hey blade	534
Hey dissection retractor	534
Hey vertebra pins	534
Heymann nasal scissors	48, 433
Heymann septum forceps	379
Heymann-Knight nasal polypus forceps	391
Heywood-Smith forceps	201, 433, 434
Hirschmann anoscope with obturator	258
Hoehn artery forceps	510
Hoehn dura dissector	549
Hoesel needle holder	305
Hohmann bone elevator	264
Hohmann elevator	261
Hook	248, 249, 348
Hook arm	248, 249
Hook clamp	248, 249
Hook handle (couple)	559
Horizontal bar	248, 249
Horsley nerve root retractor	529
Hosobuchi pituitary instrument	558
Hough nasal scissors	48
House ear curette	412
House suction irrigation tube	333
Howarth nasal elevator	409
HTT fiber optic cable	364
Huber universal handle	384
Humby transplantation knife	28
Hurd nasal raspatory	411
Hurd tonsil raspatory	411, 434, 435

<b>I</b>	
Incision scissors	31
Inge lamina spreader	545
Instrument for removal of I.U.D.	465

Iowa suction tube	332
Iowa tenaculum forceps	460
Iowa tube	494
Iris forceps	87
Iris scissors	61, 67, 70
Israel retractor	214
Iverson trachea retractor	396, 435
Ives-Fansler anoscope with obturator	258

## J

Jacobs gynaecological forceps	459
Jacobson micro instrument	503
Jacobson micro-needle holder	307, 309
Jaeger eye lid plate	254
Jaeger strabismus hook	210
Janet syringe	347
Jansen mastoid forceps	380
Jansen retractor	231
Jansen-Middleton nasal cutting forceps	378
Javid atrauma forceps	155
Jennings mouth retractor	397
Jeweler forceps	92
Johns-Hopkins bulldog clamp	99
Jones towel forceps	168
Joseph delicate hook	207
Joseph knife for nose plastic surgery	370
Joseph nasal elevator	409
Joseph nasal rasp	418
Joseph nasal saw	419
Jurasz polypus forceps	387

## K

Kabierske cannula	361
Kabierske powder blower	361
Kabierske spare bottle	361
Kabierske valve rubber bulb	361
Kantrowitz dissecting and ligature forceps	119
Kelly artery forceps	106, 113
Kelly fistula scissors	35, 443
Kelly polypus forceps	201
Kelly proctoscope with obturator	258
Kelly retractor	221
Kelly sphincteroscope with obturator	258
Kelly-Rankin artery forceps	106
Kepák gynaecological forceps	458
Keratoplastic forceps	89
Kerrison laminectomy punch	521
Kerrison punch	381
Kerrison sphenoid punch	381
Kevorkian biopsy forceps	453
Kevorkian biopsy tip	455
Kevorkian suction biopsy curette	489
Kevrokan-Pacific biopsy forceps	448
Key for Caspar retractor	538
Kielland forceps	463
Kielland-Luikart forceps	463
Kilian nasal polypus forceps	391
Killian nasal elevator	409
Killian nasal speculum	404, 433
Killian septum scissors	372, 433
Killian-Claus nasal chisel	425
Kilner dissecting scissors	41
Kilner needle holder	300
Kirschner abdominal retractor	244
Kirschner ligature needle	315
Kirschner retractor	244
Clapp knife	24
Kleinert-Kutz bone rongeur	177
Klinikum Berlin tubing clamp	170
Klinkenbergh-Loth artery scissors	46
Knife	348
Knife for varices	24
Knight septum forceps	379
Koerte retractor	213
Kogan endospeculum	478

Kocher abdominal retractor	216, 221
Kocher artery forceps	104, 105, 107
Kocher goitre probe	431
Kocher retractor	212, 216, 221
Kocher-Delicate artery forceps	101
Kolibri iris forceps	89
Kolibri iris micro forceps	89
König ligature needle	316
König nail splitting scissors	58
Koos micro instrument	502
Koutný iris forceps	88
Kraus micro instrument	502
Krause tip	385
Krayenbühl nerve hook	532
Kressner septum forceps	392
Kristeller vaginal speculum	468
Kroenig tongue depressor	400
Kuehne clamp for microscopic slides	73
Kuhnt capsule forceps	88

<b>L</b>	
La Force adenotom	371
La Force spare blades	371
Lahey ear forceps	388
Lahey gall duct clamp	122
Lachrymal sac raspator	272
Lambert chalazion forceps rounded	88
Lambert-Kay atrauma forceps	145
Lambotte neurosurgical osteotome	561
Laminectomy retractor	240
Laminectomy rongeur	513
Landau vaginal speculum	471
Landolt pituitary instrument	522, 557
Landolt spreader for specula for hypophysectomy	547
Landolt-Reulen pituitary instrument	558
Lane tissue forceps	79
Lane towel forceps	168
Lang eye spoon	279
Lange polypus forceps	387
Lange tip	385
Lange-Hohmann bone elevator	265
Langenbeck amputating knife	25
Langenbeck ear curette	413
Langenbeck elevator	261
Langenbeck needle holder	305
Langenbeck raspator	269
Langenbeck retractor	215, 435
Langenbeck-Delicate needle holder	305
Langenbeck-Ryder needle holder	305
Laryngeal micro forceps	393
Laryngeal mirror	406
Lawrence dissecting forceps	118
Lebsche sternum chisel	289
Lees atrauma forceps	148
Leland-Jones atrauma forceps	138
Lempert curette	412
Lempert ear elevator	408
Lempert raspator	411
Leriche artery forceps	104
Lewis nasal rasp	420, 423
Lexer dissecting scissors	41
Lexer scissors	67
Lexer-Baby dissecting scissors	40
Lid retractor	231
Lid retractor micro	231
List of saw	284
Lister bandage scissors	56, 67
Lister sinus forceps	199
Lister-Excentric scissors	56
Liston bone rongeur	179, 180
Littauer ligature scissors	53
Littauer-Liston bone rongeur	181
Löbker tongue holding forceps	393
Lopez-Reinke dissector	410
Lorenz bandage scissors	55
Lorna towel forceps	169

Love modif. nerve root retractor	530
Love nerve root retractor	530
Love-Gruenwald rongeur	516
Lower kidney pedicle forceps	122
Lubet-Barbon nasal polypus forceps	391
Luc septum forceps	379
Lucae ear anatomical forceps	85
Lucae ear elevator	407
Lucae hooklet	407
Lucae paracentesis needle	365
Lucae tuning fork	362
Luer bone rongeur	173–176
Luer-Koerte gall stone scoop	278
Luer-Lock suction and irrigating tube	334
Luer-Stille bone rongeur	176
Luethy-Beck needle holder	305
Lukens trachea hook	396

## M

Magill aspirating tube	332
Magill catheter introducing forceps	190
Mallet metallic	290, 433
Mallet ortopaedical	291
Maltz nasal rasp	420
Manometer only for Schulzte Salpingograph	441
Markham-Meyerding retractor	235
Markwalder bone rongeur	180
Marquard bone rongeur	176
Maršik tonsil forceps	85, 434
Martin nerve root retractor	530
Martin pelvimeter	441
Martin uterine sound	491
Masing chisel	428
Masing knife	370
Masing nasal elevator	409
Masing nasal rasp	421
Masing osteotome	428
Masson needle holder	302
Mathieu needle holder	296, 303
Mathieu retractor	228
Mathieu-Ryder needle holder	304
Mayfield bone rongeur	176
Mayo dissecting scissors	39, 59, 62, 68
Mayo safety pins	351
Mayo tongue depressor	400, 433
Mayo-Adams retractor	236
Mayo-Hegar needle holder	295, 298, 433
Mayo-Hegar-Delicate needle holder	295
Mayo-Robson intestinal forceps	127
Mayo-Stille dissecting scissors	39, 59, 433, 435
Mayo-Stille scissors	63, 68
McGee hooklet	367
McGee micro ear forceps	375
McIndoe cartilage scissors	47
McIndoe dressing forceps	78
McIvor mouth retractor	398, 432, 434
McKenty nasal elevator	409
McKenzie brain clip applying forceps	527
McClean obstetrical forceps	463
Measuring instrument	16
Medicine spoon	15
Meeker artery forceps	112
Menghini biopsy needle	330
Meniscus knife	27
Metal catheter	342
Metzenbaum dissecting scissors	37, 60
Metzenbaum needle holder	304
Metzenbaum scissors	63, 64, 68, 69
Metzenbaum-Delicate dissecting scissors	38, 60
Metzenbaum-Delicate scissors	38, 65, 66, 69, 70
Metzenbaum-Nelson dissecting scissors	37, 60
Meyhöfer chalazion spoon	279
Micro ear forceps	375
Micro forceps	507, 508
Micro instrument	525, 552, 553
Micro scissors	53, 504–506



Micro-Adson dressing forceps	78
Micro-Adson tissue forceps	78
Micro-bulldog artery forceps	98
Micro-instrument	511
Micro-Mosquito artery forceps	103
Micro-needle holder	310
Microvascular needle holder	299
Middeldorpf retractor	218
Michel clip forceps	317
Michel clips	317
Michel suture forceps	317
Mikulicz abdominal retractor	224
Mikulicz peritoneal clamp-forceps	128
Mikulicz retractor	224
Milan biopsy curette	488
Miller-Colburn nasal rasp	422
Millesi micro scissors	505
Milligan dura dissector	550
Mini-Friedman bone rongeur	173
Mini-Hohmann bone elevator	263
Mini-Langenbeck retractor	209, 435
Mini-Townsend biopsy tip	455
Miskimon retractor	233
Mixter dissecting forceps	117
Mixter-O'Shaughnessy dissecting forceps	117
Mod. Bonn extra delicate scissors	34
Mod. Wien nasal speculum	405
Moeltgen goniometer	16
Mollison retractor	233
Molt mouth retractor	397
Moritz-Schmidt tongue depressor	399
Morris-De Bakey atrauma forceps	150
Mosquito-Halsted artery forceps	102, 433, 435
Museux gynaecological forceps	459
Myles nasal cutting forceps	377

## N

Nabatoff varicose vein probe	323
Naegele perforator	462, 465
Nagel micro scissors	504
Nail scissors	58
Narrow punch	560
Nasal alar hook	395, 433
Nasal gouge	424
Nasal plastic chisel	424, 433
Nasal probe	431
Needle	367
Needle case	355
Needle holder	295-297, 302, 304, 434
Needle holder for plastic surgery	311
Negus gall duct clamp	123
Neivert chisel	428
Nelson grasping forceps	82
Nerve hook	532
Nerve root retractor	530
Neurosurgical needle holder	311
New Orleans needle holder	300
New port vaginal retractor	479
Nicola micro instrument	525
Nicola pituitary instrument	555
Non-traumatic forceps	90
Northbent ligature scissors	53
Nott vaginal speculum	473
Notto polypus forceps	200
Novak aspiration curette	489
Noyes iris scissors	51

## O

O'Sullivan-O'Connor abdominal retractor	243
O'Sullivan-O'Connor retractor	479
Oehler tissue forceps	92
Ochsner atrauma forceps	151
Ochsner-Kocher artery forceps	109, 432, 434, 435
Okonek micro instrument	533
Oldberg rongeur forceps	518

Olive	323
Olivecrona brain spatula	546
Olivecrona-Toennis applying forceps	527
Olivercrona dura dissector	550
Olivercrona wire saw	559
Ollier raspatory	270, 271
Olsen-Hegar needle holder/scissors	295, 303
Operating knife	21, 22
Operating knife for gynaecology	442
Oscillating plaster-saw	283
Otis urethrotome, mod. Keitzer	343
Ouinke biopsy needle	330
Overholt artery forceps	111
Overholt lobectomy forceps	110
Overholt-Geissendoerfer forceps	110
Overholt-Mixter artery forceps	114

## P

Parametrium clamp	129
Parametrium scissors	62
Parker retractor	227, 228
Parker-Langenbeck retractor	228
Payr ligature needle	316
Pean artery forceps	101, 104, 107
Pean-Delicate artery forceps	101
Pederson vaginal speculum	473, 477
Peers towel forceps	169
Peet splinter forceps	84
Pelkmann dressing forceps	201
Penfield dura dissector	551
Percy amputation shield	250
Phaneuf hysterectomy forceps	126, 447
Phlegmon knife	370
Piper obstetrical forceps	462
Pituitary instrument	522
Plaster scissors	55
Plaster-of-paris shears	56
Plastic hook	225
Plattfuss laminectomy punches	521
Plester knife	368
Plester retractor	236
Plester suction tube	334
Politzer air bag	361
Politzer connecting nozzle	361
Politzer ear speculum	401
Politzer furuncle knife	369
Politzer paracentesis needle	365
Politzer point	361
Poole suction tube	336
Post mortem hammer with hook	290
Post mortem knife	26
Post mortem suturing needle	318
Potts atrauma forceps	136
Potts-De Martel artery scissors	45
Potts-Smith dressing forceps	80
Potts-Smith micro-needle holder	307
Potts-Smith scissors	65
Potts-Smith tissue forceps	80
Potts-Smith vascular forceps	43
Pozzi gynaecological forceps	456
Pratt gynaecological forceps	457
Pratt haemorrhoidal forceps	130
Pratt rectal speculum	257
Pravaz injection needle	329
Presbyterian tubing clamp	170
Prince tonsil scissors	48, 432, 434
Probe	321
Probe olive	321
Probe olive with chisel	321
Probe tip only metal	323
Probe tip plastic material	323
Providence-Hospital artery forceps	104
Přecechtěl nasal raspatory	411, 434
Putti rasp	285

## Q

Quinby gum scissors	57
Quiver	350
Quiver for forceps	350
Quiver for tweezers	350

## R

Rabiner percussion hammer	13
Raimondi artery forceps	510
Ramathibodi tubual hook	495
Ramathibodi uterine manipulator	495
Rampley sponge holding forceps	204
Randal suction biopsy curette	489
Randall kidney stone forceps	198
Rasp	418
Raspatory	271
Ray pituitary instrument	555
Recamier uterine spoon	480
Recamier/Sims uterine curette	484
Rehn transplantation knife	28
Reiner plaster knife	25
Reposition forceps	193
Resection hook	394
Resection knife	22
Retractor	207, 231, 237, 542
Retractor base	248, 249
Reverdin abdominal spatula	253
Reverdin needle	313
Reynolds dissecting scissors	42, 61
Rib Forceps	182
Ricard abdominal retractor	247
Richardson retractor	219
Richardson-Eastman retractor	219
Richter operating scissors	31
Roberts artery forceps	115
Roeder towel forceps	169
Rochard abdominal retractor	249
Rochester-Carmalt artery forceps	113
Rochester-Ochsner artery forceps	105
Rochester-Pean artery forceps	108, 432–435
Rosen bur	429
Rosen knife	368
Rosen needle	366, 367, 433
Rosen suction tube	332
Rosenberg tip	385
Roser-König mouth retractor	397
Roux retractor	227
Rubber end-pieces only for Young forceps	393
Rubber tube and bulb only for Siegle speculum	403
Rubin osteotome	427
Rumel dissecting forceps	116
Ruskin bone rongeur	174, 178
Russ. Modell tissue forceps	82
Ryder/French-Eye needle holder	299

## S

Saenger ovum forceps	460
Sachs dura dissector	549
Sachs nerve root retractor	529
Saigres gynaecological forceps	458
Samii micro instrument	554
Santulli atrauma bulldog clamp	131
Sanvenero dissecting scissors	42
Sarot artery forceps	115
Sarot needle holder	302
Satinsky atrauma forceps	144
Satinsky neurosurgical scissors	46
Satinsky vena-cava forceps	167
Sauerbruch raspatory	271
Sauerbruch rib forceps	182
Sauerbruch-Frey forceps for ribs	183
Saunders instrument for removal I.U.D.	492
Saw blade for hard plaster	283
Scalpel blades	20

Scalpel handle	19, 433–435
Scoville blade	540
Scoville nerve root retractor	529
Scoville-Haverfield retractor	540
Scoville-Richter retractor	541
Segond myom knife	442
Seiffert tip	385
Selverstone rongeur	517
Semb dissecting forceps	120
Semken dissecting forceps	92
Semken dressing forceps	78
Semken tissue forceps	78
Semm abdominal retractor	244
Semm vaginal speculum	474
Senning (Swed. Mod) needle holder	300
Senn-Miller spinal hook	211
Septum nasal elevator	408
Septum needle	331
Sequestrum forceps	191
Set of jaws for forceps Hercules	186
Set of rubber jaws for forceps Hercules	186
Setting forceps for bulldog clamps	99
Seutin plaster-of-paris shears	56
Sewall nasal curette	414
Seyffert vaginal speculum	474
Shambaugh needle	366
Shapleigh ear curette	413
Shea ear curette	412
Sheehan osteotome	427
Schaedel towel forceps	168
Schede bone curette	276
Scheinmann grid tip	385
Scheinmann tip	385
Scherback vaginal speculum	470
Schink transplantation knife	28
Schlesinger rongeur	517
Schmeden nasal cutting forceps	377
Schmieden-Payr ligature needle	316
Schmieden-Taylor dura scissors	45
Schmidt-Sawtell artery forceps	113
Schröder gynaecological forceps	456, 457
Schubert biopsy forceps	450, 451
Schuknecht knife	368
Schultze set for hystero-salpingography	441
Schumacher biopsy forceps	453
Schumacher tip	385
Schumacher-Van Doren biopsy forceps	452
Schwartz micro-bulldog forceps	98
Schwartz ear hook	394
Schwartz paracentesis needle	365
Siebolt uterine scissors	36, 444
Siegle ear speculum	403
Siegle otoscope set	403
Silver chisel	428
Simon fistula hook	467
Simon/Schröder uterine scoop	481
Simplex cheek retractor	399
Simpson obstetrical forceps	463
Simpson-Braun obstetrical forceps	463
Sims gynaecological scissors	36, 444
Sims rectal speculum	257
Sims Swed. model uterine sound	491
Sims uterine probe	492
Sims uterine sound	491
Sims vaginal speculum	469
Sims/Recamier uterine curette	485
Sims-Special uterine sound	491
Singley-Tuttle forceps	82
Skull breaker	289
Smellie decapitation hook	466
Smellie perforator	465
Smith (mod. USA) bandage scissors	55
Smith-Peterson bone rongeur	178
Smithwick nerve hook	531
Snellen loop	414
Somer uterine elevating forceps	460
Spanner	283

Spare blade for 112 91 0264	370
Spare blade for La Force	371
Spencer ligature scissors	53
Spinal spoon	280
Splinter forceps	84, 433
Sponge holding forceps	202
Spoon	275
Spoon orthopaedic	280
Spratt bone curette	277
Spurling rongeur	516
Spurling rongeur	516
St.Clair-Thompson adenoid curette	416
Standard dressing forceps	74
Standard operating scissors	32, 33, 59
Standard tissue forceps	74
Standard tongue depressor	400
Stellbrink bone rongeur	173
Sterilization box	354
Sterilization sieve	353
Sternum needle holder	306
Stevens tenotomy scissors	50, 61, 70
Stieglitz splinter forceps	84
Stille chisel	292
Stille kidney pedicle clamp-forceps	121
Stille plaster of paris shears	189
Stille-Barraya tissue forceps	81, 434
Stille-Ruskin bone rongeur	177
Strully neurosurgical scissors	45
Strümpel ear forceps	374
Strümpel ear polypus forceps	374
Struycken nasal cutting forceps	377, 378
Subramanian atrauma forceps	166
Subramanian-miniature atrauma forceps	166
Suction head with magnification	403
Suture forceps	508
Suture tying forceps	83
Suturing forceps	73, 89
Swab wire	431
Syringe	347

## T

Tabb knife	368
Takahashi nasal cutting forceps	378
Tarnier basiotribe	464
Taylor blade	540
Taylor bone elevator	266
Taylor dressing forceps with dissector	79, 433
Taylor neurological reflex hammer	13
Taylor tissue forceps with dissector	79
Teale gynaecological forceps	459
Technical forceps	84
Thoms-Gaylor biopsy forceps	451
Thorek dissecting scissors	40
Tieck-Halle nasal speculum	405
Tischler biopsy forceps	449, 451
Tischler handle	455
Tischler tip	455
Tischler-Kevorkian biopsy forceps	448
Tischler-Morgan biopsy forceps	449
Tissue forceps	74, 75, 77, 433, 435
Tobold tongue depressor	399
Toennis dissecting forceps	119
Toennis dissecting scissors	45
Toennis dura dissector	548
Toennis-Adson-Delicate scissors delicate	67
Tohoku-Japan towel forceps	169
Tongue spatula	400
Tonsil needle	331
Toynbee ear speculum	401
Tracheal hook	396, 435
Tray	352, 432
Troeltsch ear forceps	85
Troeltsch nasal forceps	85, 432
Troemner percussion hammer	14
Trousseau retractor	398
Tubing clamp	170

Tubing clamp with clip	170
Tubing forceps	170
Tuffier artery forceps	100
Tuffier kidney spatula	254
Tuning fork aluminium	363
Tuohy biopsy needle	330
Tweezer quiver	350

## U

Ulrich polypus forceps	199
Unguent spatula	254
Universal abdominal retractor	248
Universal bandage scissors	55
Universal wire shears	67
Urological dilator	339
Urological probe with olives	324
Uterine curette	482, 483, 486
Uterine probe	492
Uterine spoon	480

## V

Valleix uterine sound	491
Van Buren dilator	341
Van Buren urethral sound	341
Van Doren biopsy forceps	452
Vannas micro scissors	505
Verbrugge reposition forceps	195
Virchow brain knife	26
Virchow cartilage knife	26
Volkman bone curette	276
Volkman retractor	212, 213
Volkman spoon	278

## W

Wagener ear hook	394
Wagner fine scissors	34
Waldmann episiotomy scissors	35, 443
Wallich uterine scoop	481
Walter chisel	427
Walter osteotome	427
Walton fine scissors	34
Walton retractor	237
Walton-Liston bone rongeur	181
Wangensteen dressing forceps	81
Wangensteen needle holder	302
Wangensteen tissue forceps	93
Weber atrauma forceps	147
Webster needle holder	301
Weight only for Scherback speculum	470
Weil-Blakesley nasal cutting forceps	376, 432, 433
Weingärtner ear forceps	390
Weitlaner retractor	232, 435
Wertheim hysterectomy clamp-forceps	124, 125, 445, 446
Wertheim operating scissors	35
Wertheim-Cullen clamp-forceps	126, 447
West nasal chisel	424, 425
Westcott tenotomy scissors	52
Westmacott nasal polypus forceps	391
Whitehead mouth retractor	397
Wieder tongue depressor	399
Wiener nasal rasp	421
Wigmore plaster-of-paris saw	283
Williger elevator	261
Williger raspatory	269
Winter abortion forceps	461
Wire cutting forceps	184-186
Wire forceps	184
Wire grasping forceps	190
Wire loop for microscopy	27
Wire loop for tonsil	417, 434
Wittner biopsy forceps	453
Wolff plaster cast forceps	189
Wrigley obstetrical forceps	462
Wullstein ear forceps	388

























Wullstein ear-scissors .....	373
Wullstein knife .....	368
Wullstein retractor .....	233

## Y

Yankauer suction connector .....	336
Yankauer suction head .....	336
Yankauer suction tube .....	336
Yasargil micro instrument .....	501, 503
Yasargil suction tube .....	335
Yasargil tumor forceps .....	83
Young retractor for prostate .....	226
Young tongue forceps .....	393

## Z

Zaufal ear hook .....	394
Zaufal-Jansen bone rongeur .....	177
Zenker dissecting forceps .....	116
Zielke laminectomy rongeur .....	512
Zöllner complete with 1 slip-on cannula .....	332

	použit do	use by
	datum výroby	date of manufacture
	výrobce	manufacturer
	nepoužívat opětovně	do not reuse
	neprovádět opětovnou sterilizaci	do not resterilize
	nepoužívat, jestliže je balení poškozeno	do not use if package is damaged
	otevřené balení nebude nahrazeno	opened packages are not replaced
	set, souprava	assortment
	seznamte se s návodem k použití	consult instructions for use
	seznamte se s návodem k použití kvůli důležitým varovným informacím	caution, consult accompanying documents
	nesterilní	non sterile
 xxx-xxx min <sup>-1</sup>	doporučené otáčky za minutu, doporučená frekvence otáčení	recommended rotation speed
	kód dávky	batch code
	katalogové číslo	catalogue number
	množství	quantity
	označuje kontrolní materiál	control
	sterilní	sterile
	sterilizováno ozářením	sterilization using irradiation
	sterilizováno ethylenoxidem	sterilization using ethylene oxide
	sterilizováno aseptickou technologií	sterile by aseptic techniques
	diagnostický zdravotnický prostředek in vitro	in vitro diagnostic medical device
	globální nomenklatura zdravotnických prostředků	global medical device nomenclature code

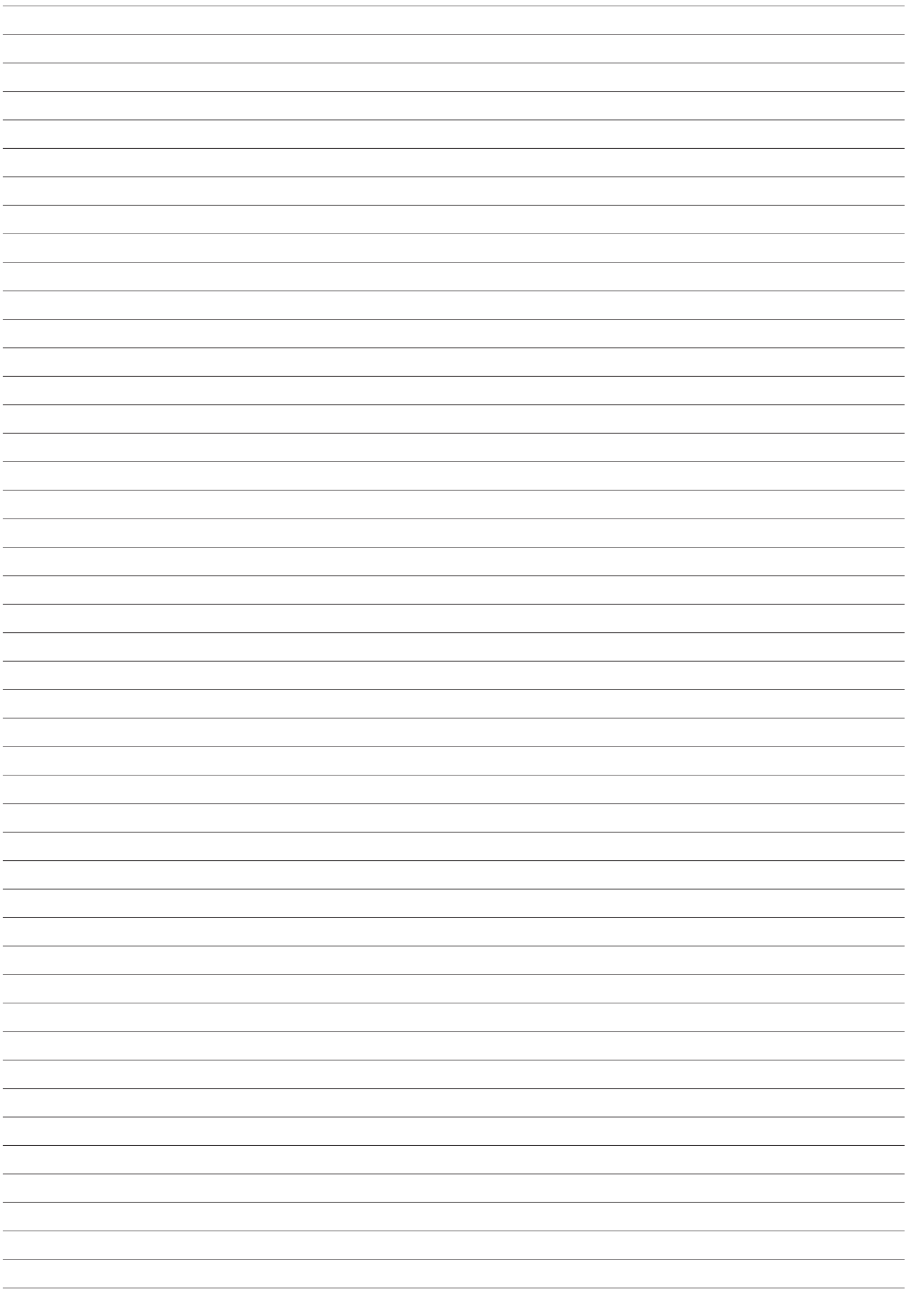

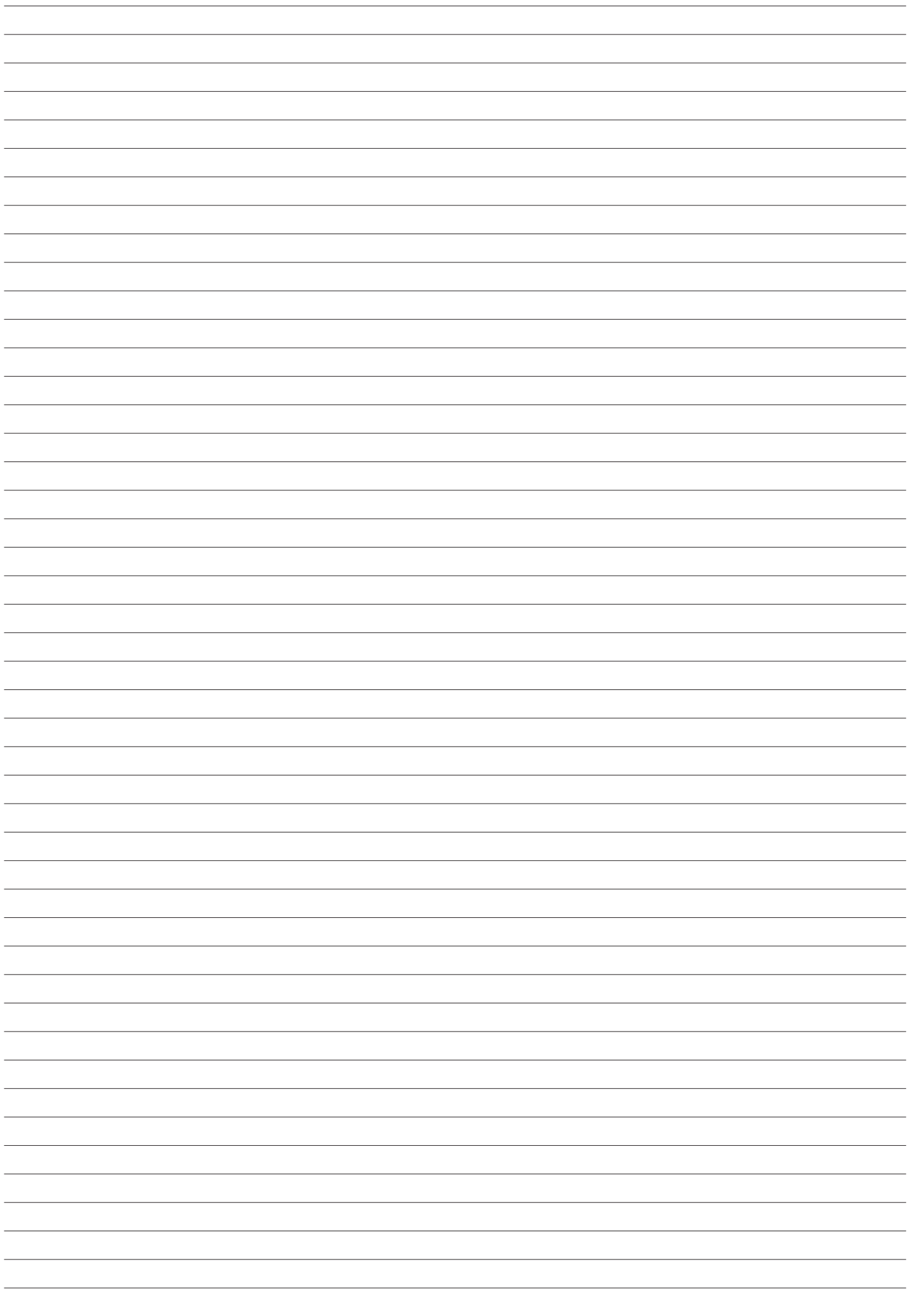

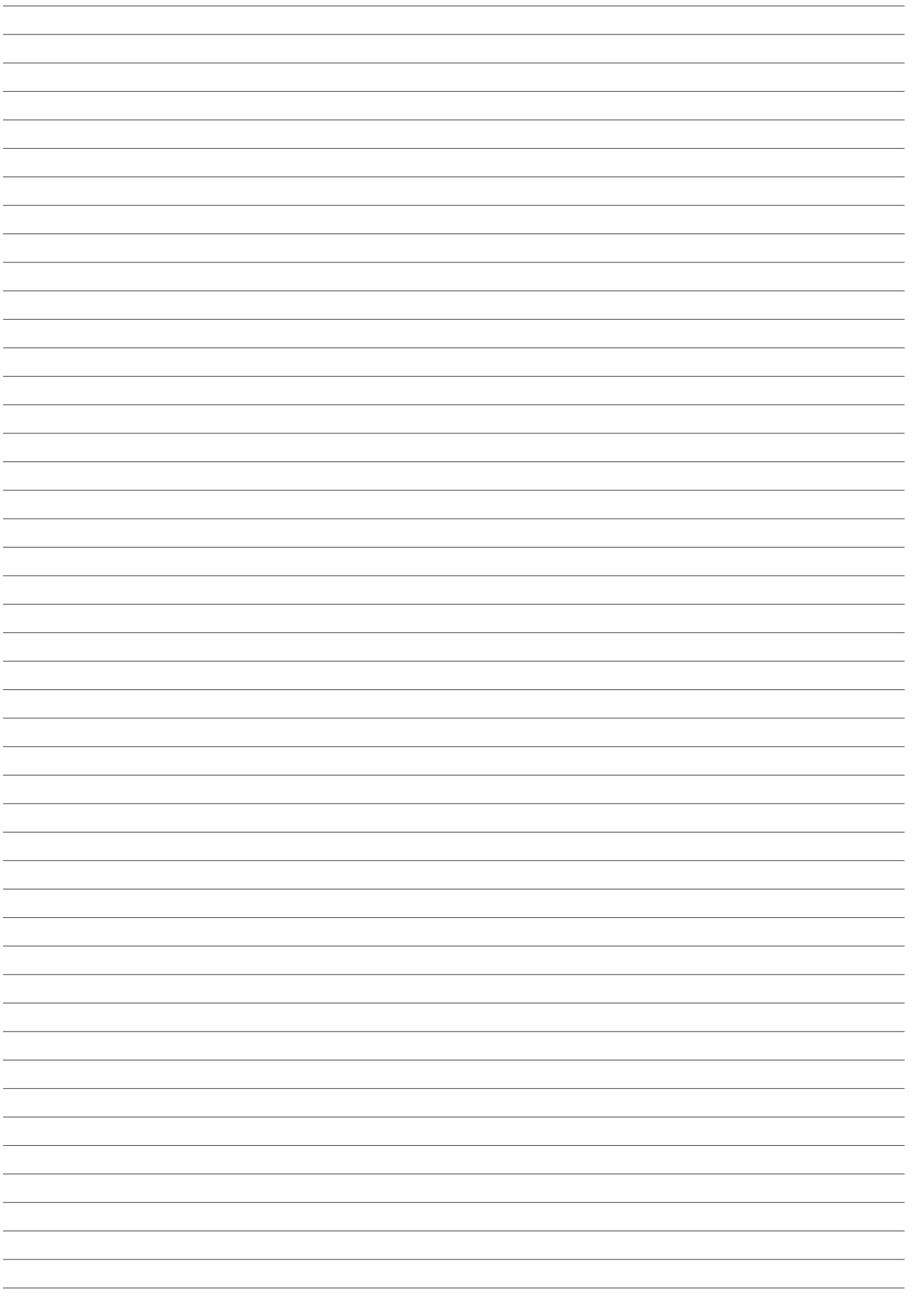



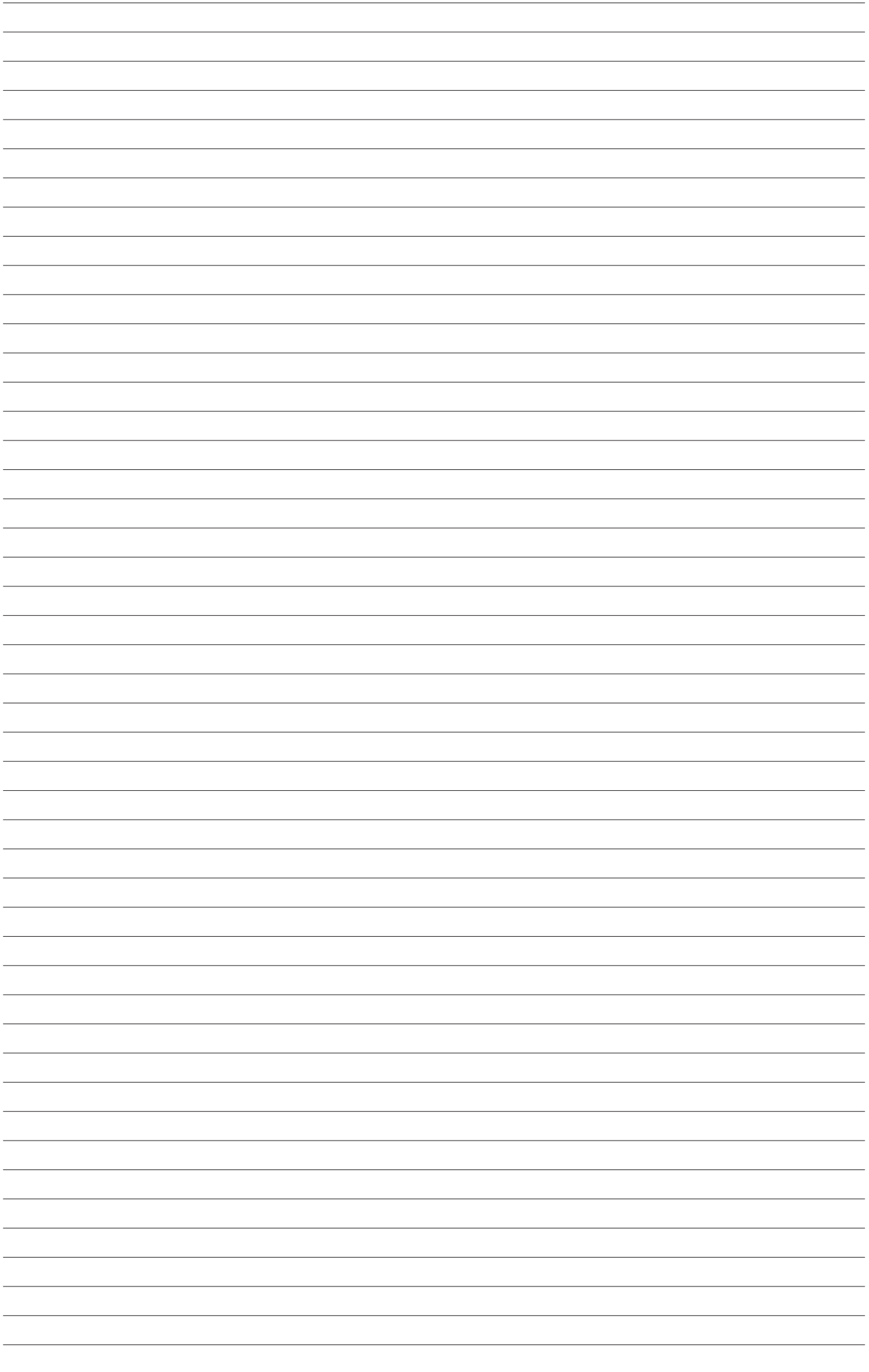

# VÁŠ SPECIALISTA NA RENOVACE LÉKAŘSKÝCH NÁSTROJŮ

## JSME PRO VÁS TOU NEJLEPŠÍ VOLBOU

- ▶ zabýváme se vývojem, výrobou a servisem lékařských nástrojů již více než šedesát let
- ▶ dlouholetá tradice firmy je zárukou naší kompetentnosti nabízet servisní služby a renovace
- ▶ používáme pouze kvalitní materiály
- ▶ zakázku vyřídíme do 10 dnů
- ▶ po domluvě možnost expresního vyhotovení zakázky
- ▶ máme příznivou cenovou politiku

## VÝHODY SERVISNÍCH SLUŽEB

- ▶ prevence vzniku nežádoucích nehod při práci s nástroji
- ▶ kontrola správného stavu, parametrů a funkcí nástrojů
- ▶ finanční úspora nákladů



NÁSTROJ  
PŘED  
RENOVACÍ



NÁSTROJ  
PO  
RENOVACI



Kontaktujte svého obchodního zástupce

[www.medin.cz](http://www.medin.cz)



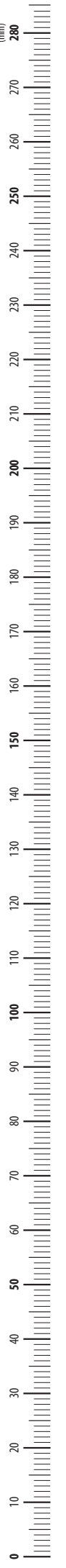



MEDIN, a.s.  
Vlachovická 619  
Nové Město na Moravě  
CZ 592 31  
Czech Republic  
IČO 43378030  
DIČ CZ43378030

**[www.medin.cz](http://www.medin.cz)**  
**[www.medin.eu](http://www.medin.eu)**

PRODEJ ČESKÁ REPUBLIKA  
tel.: 566 684 327  
fax: 566 684 384  
e-mail: [prodej@medin.cz](mailto:prodej@medin.cz)

EXPORT  
phone: +420 566 684 250  
fax: +420 566 684 385  
e-mail: [export@medin.cz](mailto:export@medin.cz)

