

HNO / plastische chirurgie

ENT / plastic surgery

ORL / cirugía plástica

ORL / chirurgie plastique

ORL / chirurgia plastica



Dies ist unser Katalog Plastische Chirurgie, er bleibt unser ausschließliches Eigentum. Es gelten unsere allgemeinen Lieferbedingungen.  
Sie finden diese auf unserer Internetseite: [www.nopa-instruments.com](http://www.nopa-instruments.com).

This is our Plastic Surgery Catalogue. It remains our exclusive property.  
Please find our "General Terms of Sale" on our corporate website:  
[www.nopa-instruments.com](http://www.nopa-instruments.com).

Esto es nuestro catálogo cirugía plástica y queda nuestra propiedad.  
Nuestras condiciones generales de venta se encuentran en nuestra página web: [www.nopa-instruments.com](http://www.nopa-instruments.com).

Voilà notre catalogue chirurgie plastique et il demeure notre propriété.  
Veuillez consulter nos conditions générales de vente sur notre page Internet : [www.nopa-instruments.com](http://www.nopa-instruments.com).

Questo è nostro catalogo chirurgia plastica e rimane nostra proprietà.  
Trovano applicazione le nostre condizioni generali di fornitura, che sono disponibili sul nostro sito: [www.nopa-instruments.com](http://www.nopa-instruments.com).

## corporate video



Scan QR-Code or visit  
[www.nopa.de](http://www.nopa.de)

Modelländerungen vorbehalten. Nachdruck, auch auszugsweise, verboten.  
Change of design and pattern reserved. Re-printing, even in extracts, not permitted.  
Nos reservamos el derecho de modificaciones sin aviso previo. Reimpresión, también parcialmente, esta prohibido.  
Tous droits réservés aux changements de modèle. Réimprimer, également partiellement, est interdit.  
Noi riserviamo il diritto di effettuare delle modificazioni. Ristampa di divieto anche parziale.

Printed in Germany 190902





**Bitte fordern Sie unsere  
entsprechenden Kataloge an.**

---

**Please request for our  
appropriate catalogues.**

---

**Por favor pida por nuestros  
catálogos apropiados.**

---

**Veillez demander nos  
catalogues appropriés.**

---

**Chieda prego i nostri  
cataloghi adatti.**

---

**>> Unser Lieferprogramm**

Allgemeinchirurgie und Gynäkologie  
Plastische Chirurgie und HNO  
Thorax, Herz und Gefäßschirurgie  
Neurochirurgie  
Ophthalmologie  
Endoskopie  
Container und Sterilisation  
Dental und Oral

**>> Our product range**

General Surgery and Gynecology  
Plastic Surgery and ENT  
Thoracic and cardiovascular surgery  
Neurosurgery  
Ophthalmology  
Endoscopy  
Container and Sterilization  
Dental and Oral

**>> Nuestro gama  
de productos**

Cirugía general y ginecología  
Cirugía plástica y ORL  
Cirugía torácica y cardiovascular  
Neurocirugía  
Oftalmología  
Endoscopia  
Contenedor y esterilización  
Odontología y oral

**>> Notre gamme**

Chirurgie générale et Gynecologie  
Chirurgie plastique et ORL  
Chirurgie thoracique et cardiovasculaire  
Neurochirurgie  
Ophtalmologie  
Endoscopie  
Conteneur et stérilisation  
Dental et Oral

**>> Nostro programma  
di produzione**

Chirurgia generale e Ginecologia  
Chirurgia plastica ed ORL  
Chirurgia toracica e cardiovascolare  
Neurochirurgia  
Oftalmologia  
Endoscopia  
Contentitore e sterilizzazione  
Odontoiatria e Orale







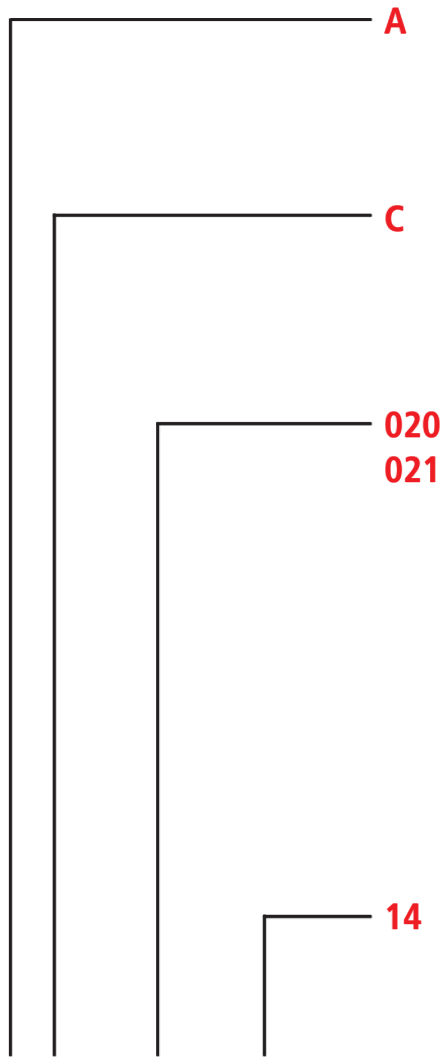

Artikelcode **AC 020/14**

#### Allgemeines Instrumentarium

General Instruments  
Instrumental Général  
Instruments Générales  
Strumenti generali

#### Scheren

Scissors  
Tijeras  
Ciseaux  
Forbici

#### Fortlaufende Nummern

Gerade Ziffer = gerades Instrument  
Ungerade Ziffer = gebogenes Instrument

#### Continuous number

Even number = straight instrument  
Odd number = curved instrument

#### Número de orden

números pares = instrumento derecho  
números impares = instrumento curvado

#### Numéros d'ordre

numéro pair = instrument droit  
numéro impair = instrument courbe

#### Numeri progressivamente

numero pari = strumento retto  
numero dispari = strumento curvo

#### Länge oder Figur

Length or Figure  
Longitud o figura  
Longueur ou figure  
Lunghezza o figura

HNO / plastische Chirurgie

ENT / plastic surgery

ORL / cirugía plástica

ORL / chirurgie plastique

ORL / chirurgia plastica

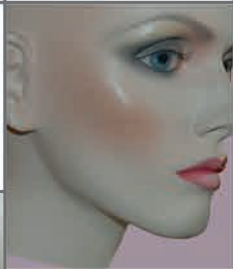
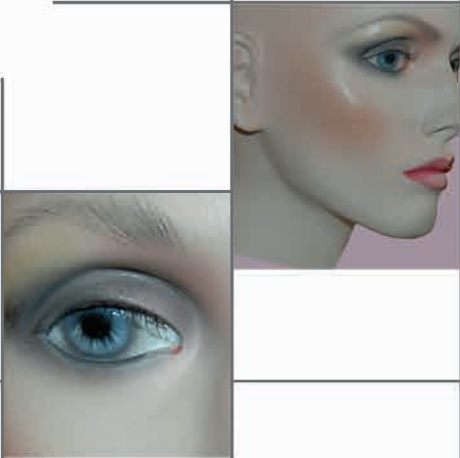

nopa<sup>®</sup> instruments





Wir weisen ausdrücklich darauf hin, dass die gezeigten/ genannten Produkte nur von ausgebildetem Fachpersonal mit entsprechender Qualifikation und unter der Voraussetzung des sachgemäßen, zweckbestimmten und bestimmungsgemäßen Gebrauchs, laut Angaben der Bedienungsanleitung verwendet und eingesetzt werden dürfen.

Unsachgemäße und die nicht bestimmungsmäßige Verwendung der Produkte, kann zu schwerwiegenden und unerwünschten Folgen, sowie Komplikationen führen.

We expressly point out that the products shown/mentioned may only be used and operated by trained specialist personnel with the appropriate qualifications, and for the proper, intended and prescribed purpose as specified in the operating instructions.

Improper and/or non-prescribed use of the products may lead to serious and undesirable consequences as well as complications.

>> Klemmen >> Hemostats >> Pinzas hemostáticas >> Pincas hémostatiques >> Pinze emostatiche	15-32	AA
>> Pinzetten >> Forceps >> Pinzas >> Pincas >> Pinze	33-58	AB
>> Scheren >> Scissors >> Tijeras >> Ciseaux >> Forbici	59-94	AC
>> Skalpelle >> Scalpels >> Bisturíes >> Bistouris >> Bisturi	95-100	AD
>> Naht >> Suture >> Sutura >> Suture >> Sutura	101-128	AE
>> Tupferzangen >> Sponge Forceps >> Pinzas para pólipos >> Pincas à pansements >> Pinze per polipi	129-134	AF
>> Wundhaken >> Retractors >> Separadores >> Ecarteurs >> Divaricatori	135-152	AK
>> Sonden >> Probes >> Sondas >> Sondes >> Sonde	153-155	AL
>> Punktion/Kanülen >> Puncture/Special Needles >> Punción/Agujas especiales >> Ponction/Aiguilles spéciales >> Puntura/Aghi speciali	156-162	AO
>> Narkose >> Anaesthesia >> Anestesia >> Anesthésie >> Anestesia	163-180	AP
>> Diagnostik >> Diagnostics >> Diagnóstico >> Diagnostic >> Diagnostica	181-194	AR
>> Orthopädie >> Orthopaedic >> Ortopedia >> Orthopédie >> Ortopedia	195-228	KA
>> Mund/Zunge/Tonsillen >> Oral Instruments/Tonsils >> Boca/Lengua/Amígdalas >> Bouche/Langue/Amygdales >> Bocca/Lingua/Tonsille	229-276	KL
>> Otologie >> Otology >> Otología >> Otologie >> Otologia	277-308	KM
>> Rhinologie >> Rhinology >> Rinología >> Rhinologie >> Rinologia	309-358	KO
>> Verschiedenes >> Various items >> Diversos Articulos >> Articles divers >> Articoli diversi	359-364	KU
>> Container System >> Container System >> Sistema de contenedor >> Système de conteneur >> Sistema del contenitore	365-388	KYE
>> Endoskopie >> Endoscopy >> Endoscopia >> Endoscopie >> Endoscopia	389-414	X



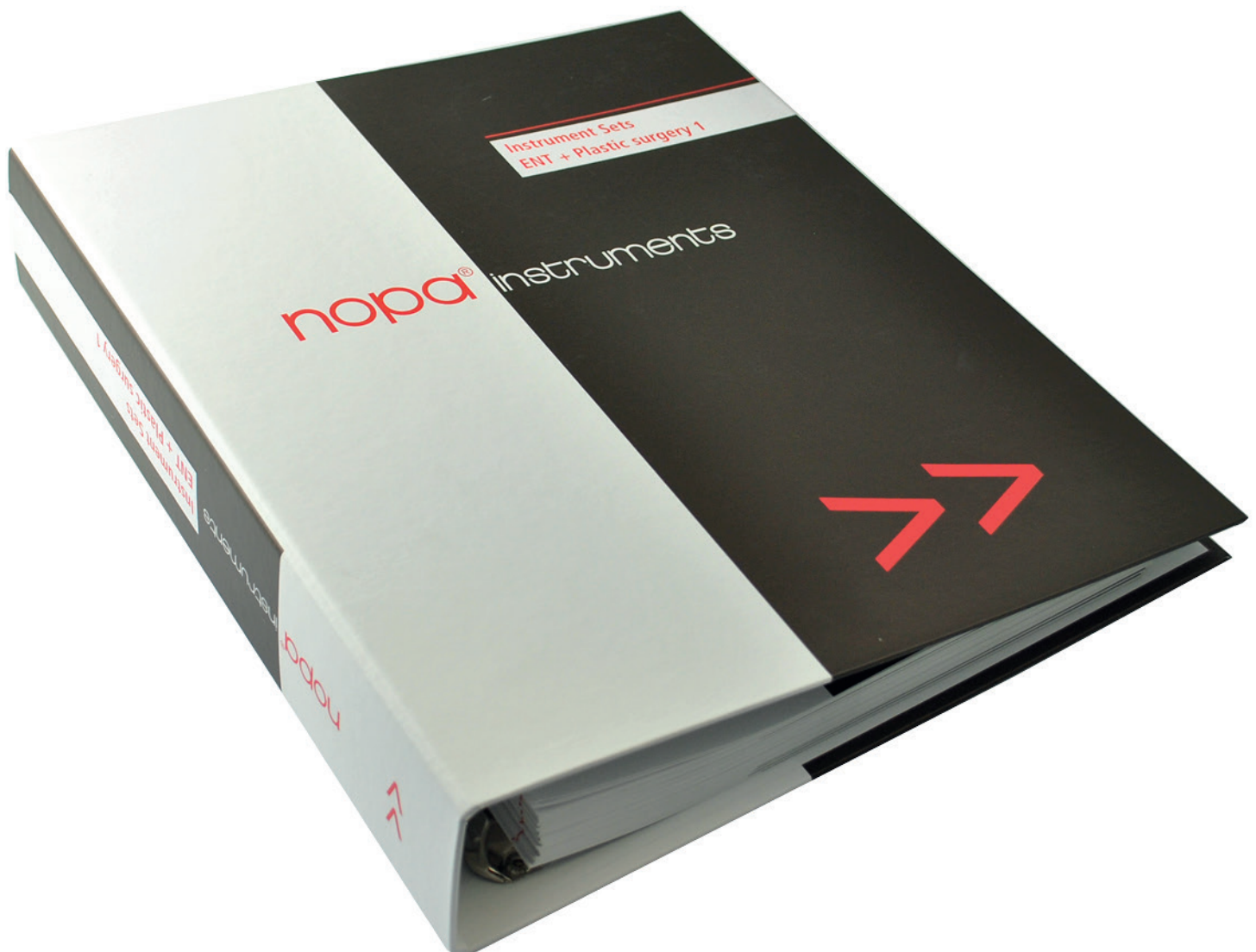

- >> Bitte fordern Sie unseren Set-Katalog mit mehr als 50 HNO Instrumenten Sieben an.
- >> Please ask for our instruments set catalogue including more than 50 ENT instruments sets.
- >> Por favor solicite nuestro catálogo de cajas incluyendo más de 50 cajas de instrumentos ORL.
- >> N'hésitez pas à faire la demande de notre catalogue de boîtes comprenant plus de 50 boîtes d'instruments ORL.
- >> La preghiamo di richiedere il nostro catalogo di set includendo più di 50 set di strumenti ORL.

**SET**

ZS 345/00

Siebvorschlag - Suggested instrument set

EXCERPT FROM  
INSTRUMENT SET CATALOGUE**ENDOSKOPISCHES FACELIFT SET****ENDOSCOPIC FACELIFT SET****SET ESTIRAMIENTO FACIAL ENDOSCÓPICO****BOÎTE LIFTING FACIAL ENDOSCOPIQUE****SET LIFTING FACIALE ENDOSCOPICO**

Content:		Qty
AK 456/01	OPTICAL DISSECTOR FOR PLAST. ENDOSCOPES 4.0 MM 30° TYP1	1
KA 690/08	LANGENBECK PERIOST-ELEV. 8 MM 19.5 CM	1
KA 709/01	MIDFACE FASCIA DISSECTOR, 23.0 CM	1
KA 709/02	TEMPORAL „T“ DISSECTOR, 25.0 CM	1
KA 709/03	SUPRAORBITAL DISSECTOR, 26.0 CM	1
KA 709/04	ARCUS MARGINALIS DISSECTOR, 25.3 CM	1
KA 709/05	FLAP DISSECTOR, 25.0 CM	1
KA 709/06	FRONTOTEMPORAL DISSECTOR, STRAIGHT, 24.0 CM	1
KA 709/07	FRONTOTEMPORAL DISSECTOR, CURVED, 24.0 CM	1
KA 709/08	ORBITAL RIM DISSECTOR, HALF CURVED, 23.5 CM	1
KA 709/09	FACELIFT DISSECTOR, STRAIGHT, 21.0 CM	1
KA 709/10	FACELIFT DISSECTOR, CURVED, 23.5 CM	1
KA 709/11	NERVE DISSECTOR, HALF CURVED, 23.5 CM	1
KA 709/30	ZYGOMATIC ARCH ELEVATOR, 22.0 CM	1
KA 709/31	PARIETAL PERIOSTAL ELEVATOR, 26.0 CM	1
KA 709/32	FACELIFT ELEVATOR, 1/4 CURVED, 23.5 CM	1
KA 709/33	FACELIFT ELEVATOR, FULL CURVED, 23.5 CM	1
KA 709/34	FACELIFT ELEVATOR, HALF CURVED, 23.5 CM	1
SK 305/06	WIRE BASKET, 485X255X60 MM	1
SU 515/29	ENDOSCOPY WIRE BASKET 290X80X52 MM	1
SX 432/02	SILICON MAT 225X225 MM	2
XM 010/00	HANDLE, INSULATED, ROTATABLE	1
XM 014/00	HANDLE W/RATCHET, ROTATABLE WITH STOP	1
XM 020/18	SHAFT, 18.0 CM, Ø 5.0 MM	1
XM 139/18	METZENBAUM, SCISSORS, CURVED, 18.0 CM, Ø 5.0 MM	1
XM 170/18	DOLPHIN, GRASPING FORCEPS, 18.0 CM, Ø 5.0 MM	1
XM 295/18	METZENBAUM, SCISSORS, CURV. JAWS, CURV., HORIZ., 18.0 CM, Ø 3.0 MM	1
XM 296/18	DOLPHIN, GRASPING FORCEPS, SHAFT CURVED, HORIZ., 18.0 CM, Ø 3.0 MM	1
XP 701/43	OPTIC F. ARTHROSCOPY/SINUSCOPY 4.0 MM 30°	1

Basic instruments for FACELIFT: Set Rhytidectomy ZS 346/00

See catalogue „Container and Sterilization“, if required.



EXCERPT FROM  
INSTRUMENT SET CATALOGUE



**OPTICAL DISSECTOR FOR ENDOSCOPES**  
**AK 456/01**  
 175 mm, Ø 4,0 mm  $\alpha = 30^\circ$

**KA 690/08**  
 19,5 cm/7<sup>3</sup>/<sub>4</sub>"



EXCERPT FROM  
INSTRUMENT SET CATALOGUE

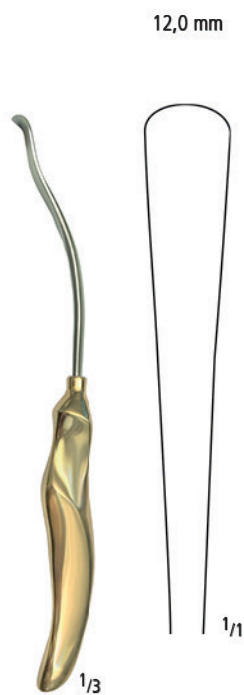

**KA 709/01**  
23,0 cm/9<sup>1</sup>/<sub>8</sub>"

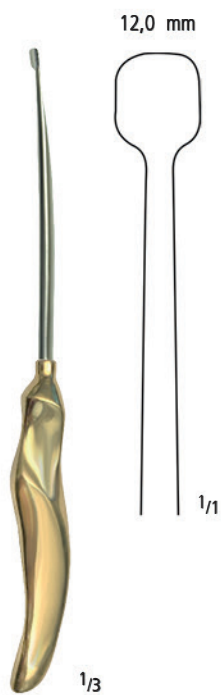

**KA 709/02**  
25,0 cm/9<sup>3</sup>/<sub>4</sub>"

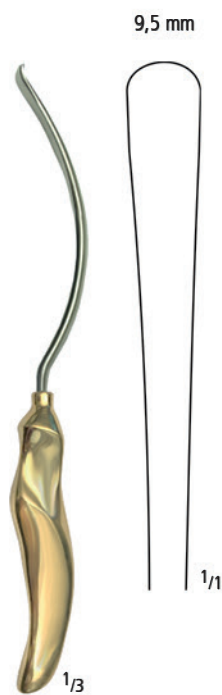

**KA 709/03**  
26,0 cm/10<sup>1</sup>/<sub>4</sub>"

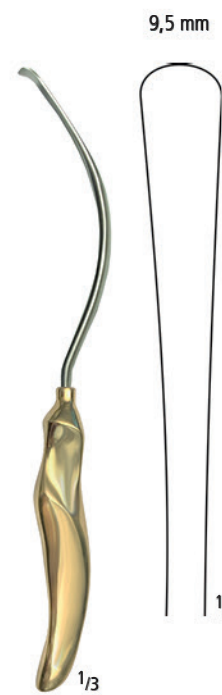

**KA 709/04**  
25,3 cm/10"

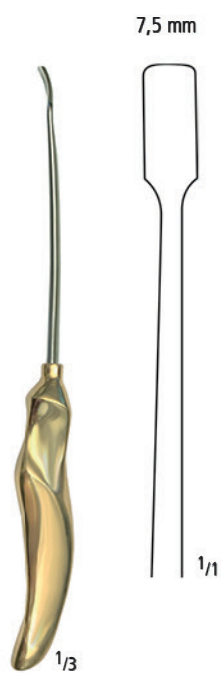

**KA 709/05**  
25,0 cm/9<sup>3</sup>/<sub>4</sub>"



**KA 709/06**  
24,0 cm/9<sup>1</sup>/<sub>2</sub>"



**KA 709/07**  
24,0 cm/9<sup>1</sup>/<sub>2</sub>"

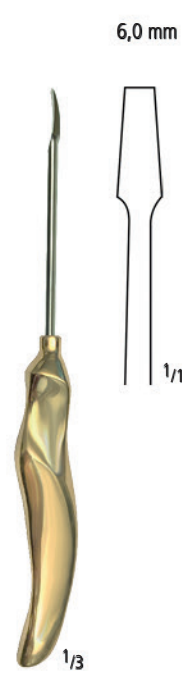

**KA 709/30**  
22,0 cm/8<sup>3</sup>/<sub>4</sub>"

neck lift

rhino basic

rhino advanced

otoplasty

facelift

facelift endoscopy

blepharoplasty

hairtransplantation

EXCERPT FROM  
INSTRUMENT SET CATALOGUE

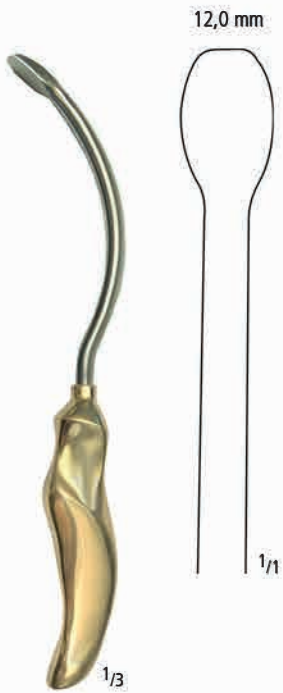

**KA 709/31**  
25,0 cm/9<sup>3</sup>/<sub>4</sub>"



**KA 709/32**  
24,0 cm/9<sup>1</sup>/<sub>2</sub>"



**KA 709/33**  
24,0 cm/9<sup>1</sup>/<sub>2</sub>"



**KA 709/34**  
23,5 cm/9<sup>1</sup>/<sub>4</sub>"



**KA 709/37**  
23,5 cm/9<sup>1</sup>/<sub>4</sub>"



**KA 709/38**  
21,0 cm/8<sup>1</sup>/<sub>4</sub>"



**KA 709/39**  
23,5 cm/9<sup>1</sup>/<sub>4</sub>"



**KA 709/40**  
23,5 cm/9<sup>1</sup>/<sub>4</sub>"

EXCERPT FROM  
INSTRUMENT SET CATALOGUE

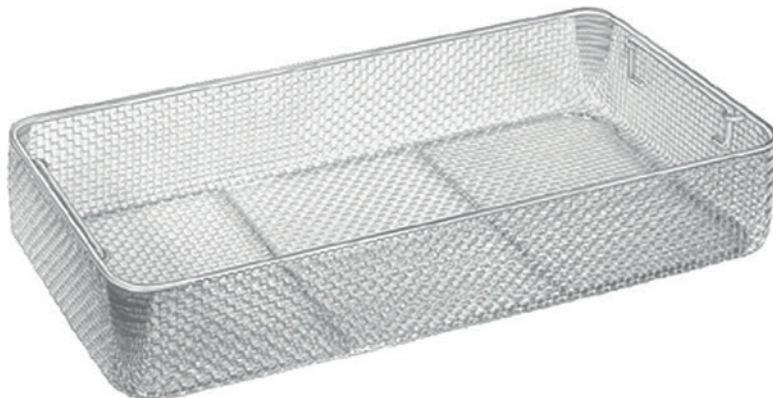

L(mm)	B(mm)	H(mm)	
485	255	60	<b>SK 305/06</b>



L(mm)	B(mm)	H(mm)	for 1 Telescope
290	80	52	<b>SU 515/29</b>

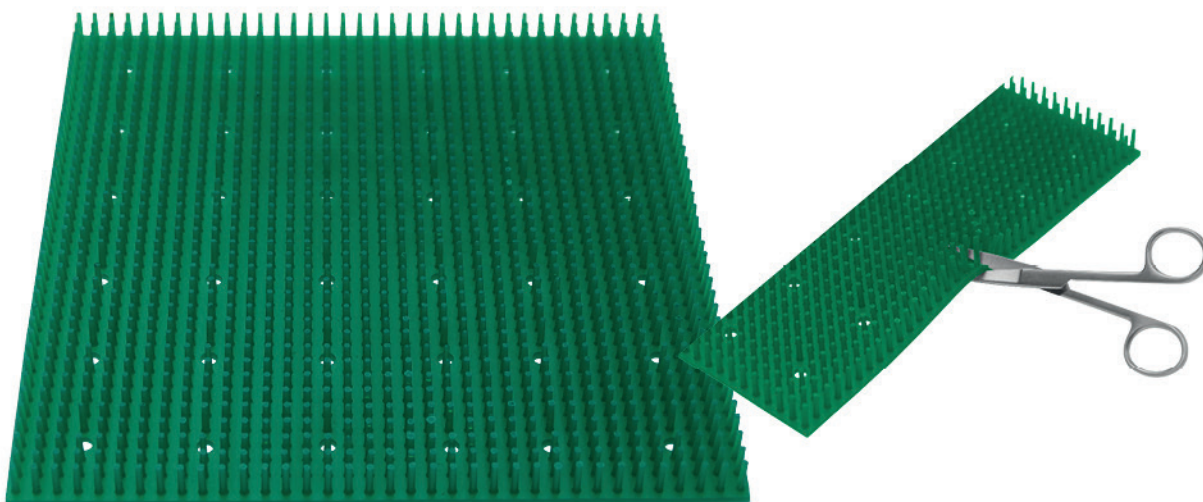

L(mm)	B(mm)	
225	225	<b>SX 432/02</b>

neck lift

rhino basic

rhino advanced

otoplasty

facelift

facelift endoscopy

blepharoplasty

hairtransplantation

EXCERPT FROM  
INSTRUMENT SET CATALOGUE



**XM 010/00**



**XM 014/00**



15 mm



Ø 5,0 mm      L      18,0 cm/7"      **XM 020/18**

maximum precision and quality standards

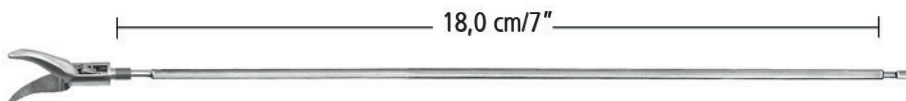

Ordering information: Please order handle, tube and working tip.



EXCERPT FROM  
INSTRUMENT SET CATALOGUE

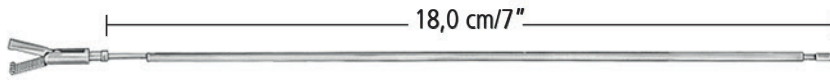

**METZENBAUM SCISSORS CURVED**

Ø 5,0 mm

**XM 139/18**



**DOLPHIN**

Ø 5,0 mm

**XM 170/18**

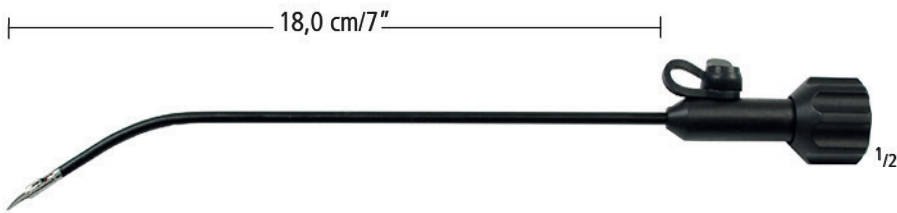

**METZENBAUM SCISSORS CURVED**

Ø 3,0 mm

**XM 295/18**



**DOLPHIN GRASPING FORCEPS**

Ø 3,0 mm

**XM 296/18**



**autoclavable**

**with adaptors for**

**Storz  
Wolf  
ACMI**



**ARTHROSCOPE**

Wide angle

Ø 4,0 mm

α = 30°

**XP 701/43**

neck lift

rhino basic

rhino advanced

otoplasty

facelift

facelift endoscopy

blepharoplasty

hairtransplantation





KLEMMEN  
HEMOSTATS  
PINZAS HEMOSTATICAS  
PINCES HEMOSTATIQUES  
PINZE EMOSTATICHE

AA

nopa<sup>®</sup> instruments

Weitere Klemmen finden Sie in unserem Katalog „Allgemeines Instrumentarium“ in Gruppe AA.

For further hemostats kindly refer to our catalogue „General Instruments“, section AA.

Para pinzas hemostaticas adicionales, por favor consulte nuestro catálogo de „Instrumental de uso general“, grupo AA.

Pour des pinces hemostatiques supplémentaires, consultez notre catalogue „Instrumentation Generale“, section AA.

Per gli altri pinze emostatiche, consultare il nostro catalogo „Strumentazione Generale“, gruppo AA.



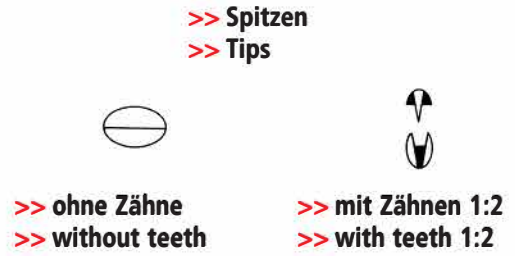
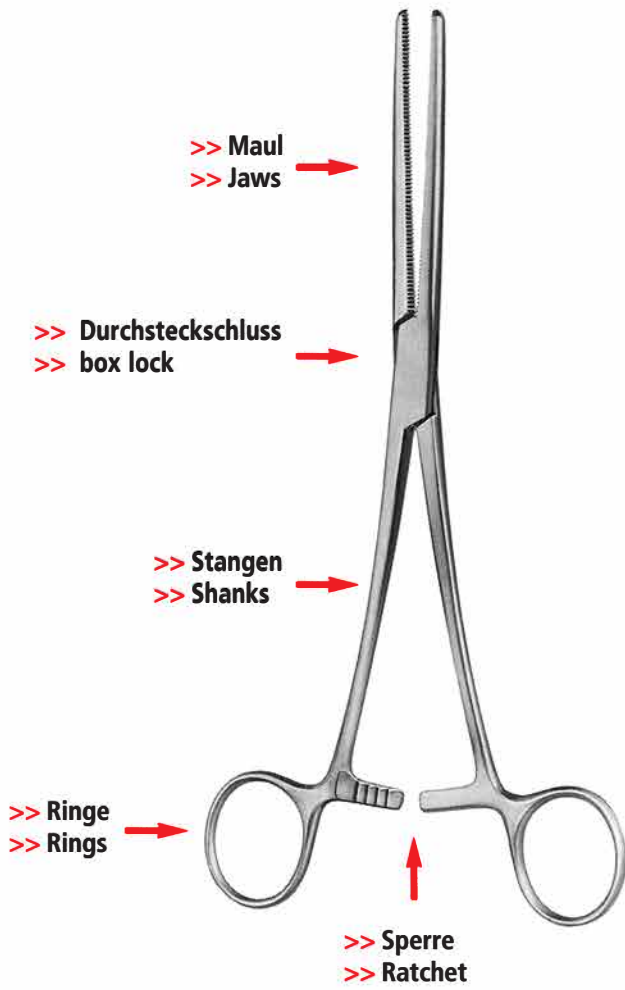

>> Maulbiegung  
>> jaw curvature

>> Riefung  
>> serrations

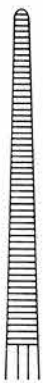

>> gerade  
>> straight

>> gebogen  
>> curved

>> quer  
>> horizontal

>> längs  
>> longitudinal

>> kreuz  
>> cross

Gewebefasszängchen  
Tissue Seizing Forceps  
Pinzas para coger tejidos  
Pinces pour saisir le tissu  
Pinze per afferrare tessuto

AA

AB

AC

AD

AE

AF

AK

AL

AO

AP

AR

KA

KL

KM

KO

KU

KYE

X



**ALLIS 4:5**  
**KD 054/15**  
15,0 cm/6"



**ALLIS 5:6**  
15,0 cm/6"  
19,0 cm/7 1/2"  
25,0 cm/10"  
**KD 055/15**  
**KD 055/19**  
**KD 055/25**



**BABCOCK**



**KD 111/16**  
16,0 cm/6 1/4"



**KD 111/18**  
18,0 cm/7"

Bulldogklemmen  
Bulldog Clamps  
Clamps Bulldog  
Clamps Bulldog  
Pinze Bulldog

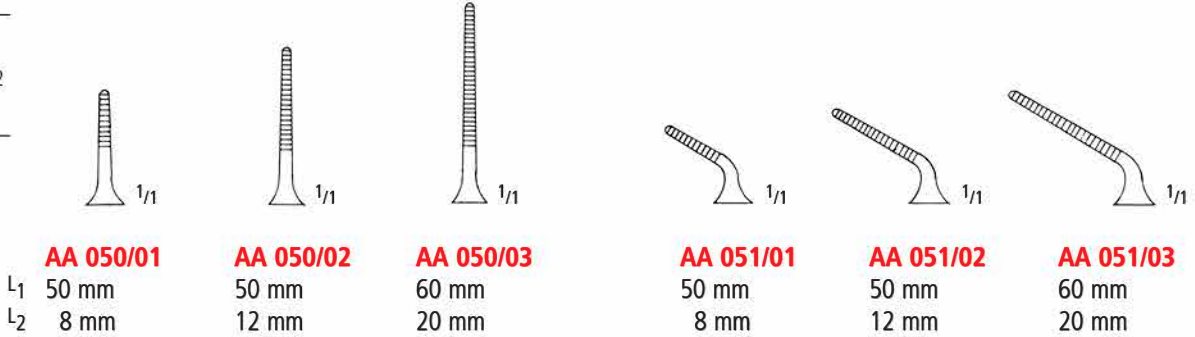
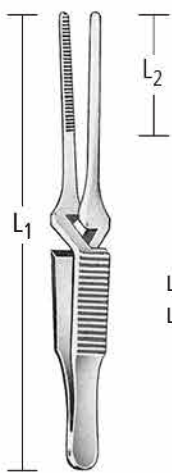

3 gr. Gewicht  
50 gr. Druck  
Gewicht Pressure  
Weight Pressure  
Peso Presión  
Poids Pression  
Peso Pressione

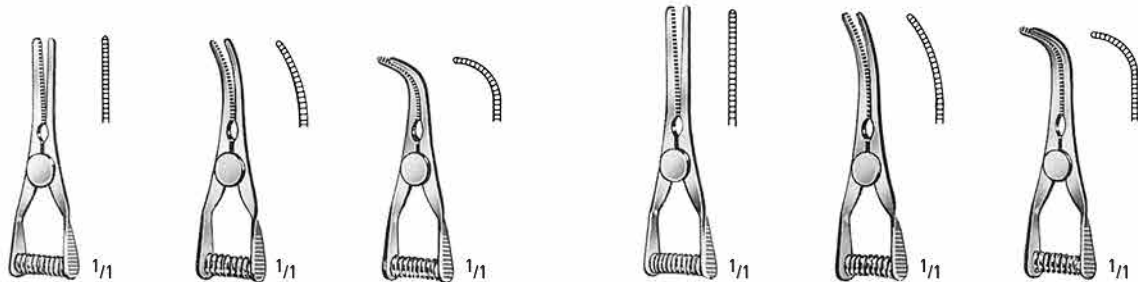

<b>VENA ARTERIA</b>	<b>AA 052/01</b>	<b>TITAN 30 mm</b>			<b>AA 052/03</b>	<b>AA 054/01</b> <b>AA 055/01</b>	<b>TITAN 35 mm</b>		<b>AA 054/03</b>
	<b>AA 053/01</b>	<b>AA 052/02</b>	<b>AA 053/02</b>	<b>AA 053/03</b>	<b>AA 054/02</b>		<b>AA 055/02</b>	<b>AA 054/03</b>	<b>AA 055/03</b>

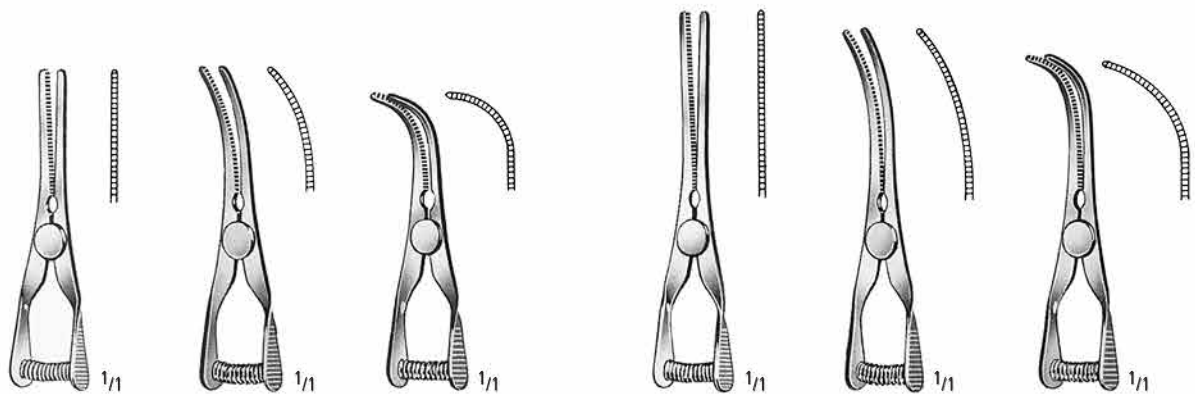

<b>VENA ARTERIA</b>	<b>AA 056/01</b>	<b>TITAN 40 mm</b>			<b>AA 056/03</b>	<b>AA 058/01</b> <b>AA 059/01</b>	<b>TITAN 50 mm</b>		<b>AA 058/03</b>
	<b>AA 057/01</b>	<b>AA 056/02</b>	<b>AA 057/02</b>	<b>AA 057/03</b>	<b>AA 058/02</b>		<b>AA 059/02</b>	<b>AA 058/03</b>	<b>AA 059/03</b>



Bulldogklemmen, Anlegezange  
 Bulldog Clamps, Setting Forceps  
 Clamps Bulldog, Pinza para poner  
 Clamps Bulldog, Pince à poser  
 Pinze Bulldog, Pinza per posizionare

AA  
 AB  
 AC  
 AD  
 AE  
 AF  
 AK  
 AL  
 AO  
 AP  
 AR  
 KA  
 KL  
 KM  
 KO  
 KU  
 KYE  
 X



**DIEFFENBACH**

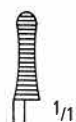

**AA 060/03**  
 3,5 cm/1 1/2"



**AA 060/05**  
 5,0 cm/2"



**AA 060/06**  
 6,0 cm/2 1/2"



**AA 061/03**  
 3,5 cm/1 1/2"

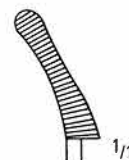

**AA 061/05**  
 5,0 cm/2"



**AA 061/06**  
 6,0 cm/2 1/2"



**JOHNS-HOPKINS**  
**AA 069/24**  
 24,5 cm/9 3/4"



**JOHNS-HOPKINS**

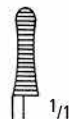

**AA 070/04**  
 4,0 cm/1 1/2"



**AA 070/05**  
 5,0 cm/2"



**AA 070/06**  
 6,5 cm/2 1/2"

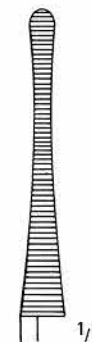

**AA 070/07**  
 7,5 cm/3"



**AA 070/09**  
 9,0 cm/3 1/2"



**AA 071/04**  
 4,0 cm/1 1/2"



**AA 071/05**  
 5,0 cm/2"



**AA 071/06**  
 6,5 cm/2 1/2"

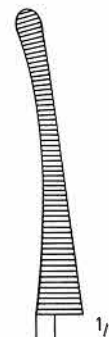

**AA 071/07**  
 7,5 cm/3"

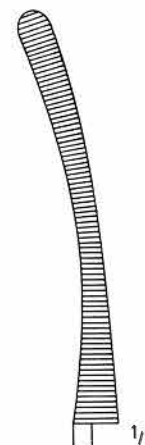

**AA 071/09**  
 9,0 cm/3 1/2"

Fasszangen  
Seizing Forceps  
Pinzas para coger  
Pinces à saisir  
Pinze per afferrare



**CHAPUT**  
**AA 072/02**  
13,0 cm/5"



**TUFFIER**  
**AA 072/04**  
13,0 cm/5"

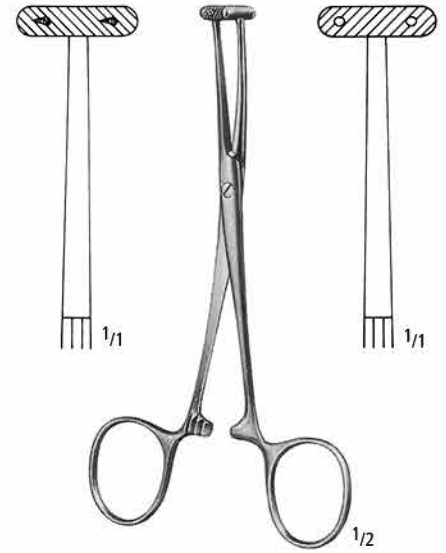

**MARTEL**  
**AA 078/14**  
14,0 cm/5½"



**PEAN**  
14,0 cm/5½" **AA 080/14**  
16,0 cm/6¼" **AA 080/16**



**AA 080/14**



**AA 080/16**

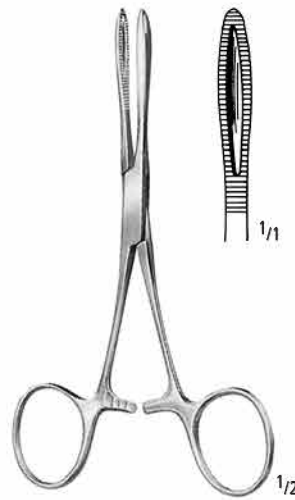

**KROENLEIN**  
**AA 082/13**  
13,0 cm/5"



**PENNINGTON**  
**AA 084/15**  
15,5 cm/6"



**AA 084/15**

Arterienklemmen  
 Artery Forceps  
 Pinzas hemostáticas  
 Pincas hémostatiques  
 Pinze emostatiche

AA

AB

AC

AD

AE

AF

AK

AL

AO

AP

AR

KA

KL

KM

KO

KU

KYE

X



**SPENCER-WELLS**

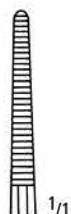

**AA 110/13**  
13,0 cm/5"

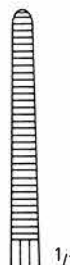

**AA 110/14**  
14,0 cm/5½"

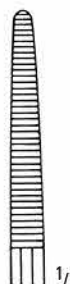

**AA 110/15**  
15,5 cm/6"

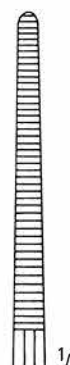

**AA 110/18**  
18,0 cm/7"

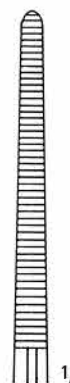

**AA 110/20**  
20,0 cm/8"



**AA 111/13**  
13,0 cm/5"

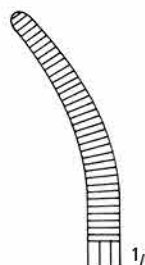

**AA 111/14**  
14,0 cm/5½"

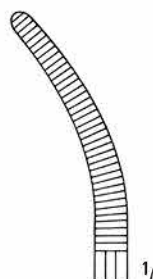

**AA 111/15**  
15,5 cm/6"



**AA 111/18**  
18,0 cm/7"



**AA 111/20**  
20,0 cm/8"



**HARTMANN**  
**AA 114/10**  
10,0 cm/4"

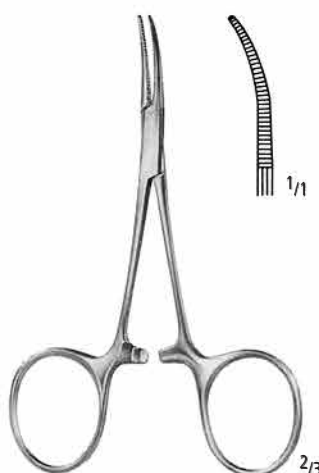

**HARTMANN**  
**AA 115/10**  
10,0 cm/4"

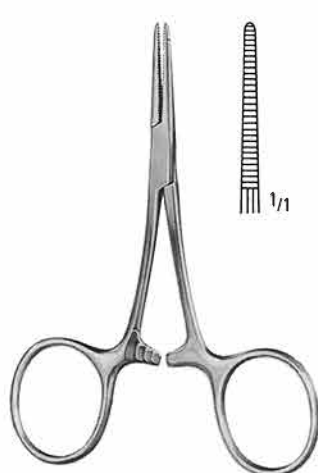

**CARREL**  
**AA 116/08**  
8,5 cm/3½"

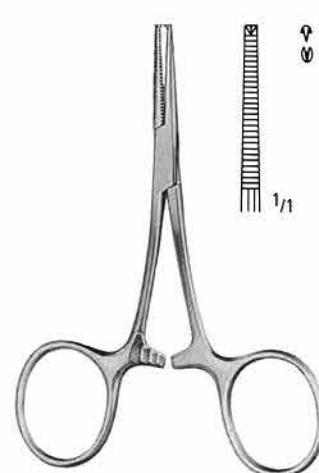

**TERRIER 1:2**  
**AA 118/08**  
8,5 cm/3½"

Feine Arterienklemmen  
 Fine Artery Forceps  
 Pinzas hemostáticas finas  
 Pincés hémostatiques fines  
 Pinze emostatiche fine

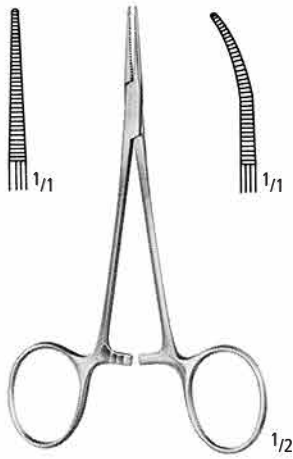

**MICRO-MOSQUITO**

AA 130/10    AA 131/10  
 AA 130/12    AA 131/12

10,0 cm/4"  
 12,0 cm/4<sup>3</sup>/<sub>4</sub>"

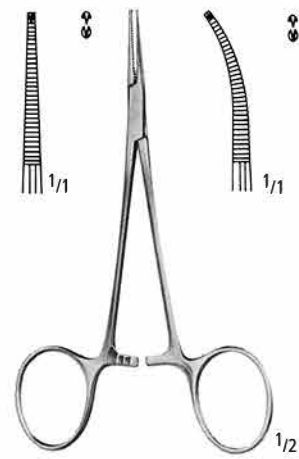

**MICRO-MOSQUITO 1:2**

AA 132/10    AA 133/10  
 AA 132/12    AA 133/12

**WILLIAM STEWART HALSTED**

was professor of surgery in the Johns Hopkins University. In 1890 he had bronze casts made of his own hands. On these casts the first surgical rubber gloves were moulded.

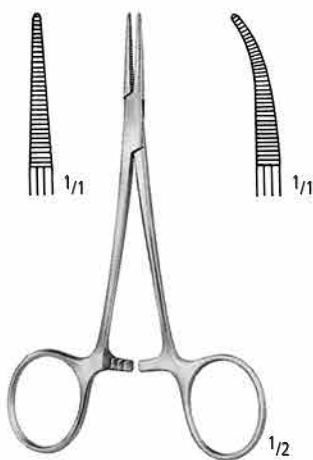

**HALSTED-MOSQUITO**

AA 150/12    AA 151/12  
 AA 150/14    AA 151/14

12,5 cm/5"  
 14,0 cm/5<sup>1</sup>/<sub>2</sub>"

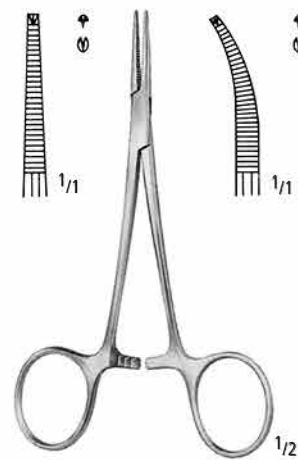

**HALSTED-MOSQUITO 1:2**

AA 152/12    AA 153/12  
 AA 152/14    AA 153/14

Arterienklemmen  
 Artery Forceps  
 Pinzas hemostáticas  
 Pincas hémostatiques  
 Pinze emostatiche

AA  
 AB  
 AC  
 AD  
 AE  
 AF  
 AK  
 AL  
 AO  
 AP  
 AR  
 KA  
 KL  
 KM  
 KO  
 KU  
 KYE  
 X

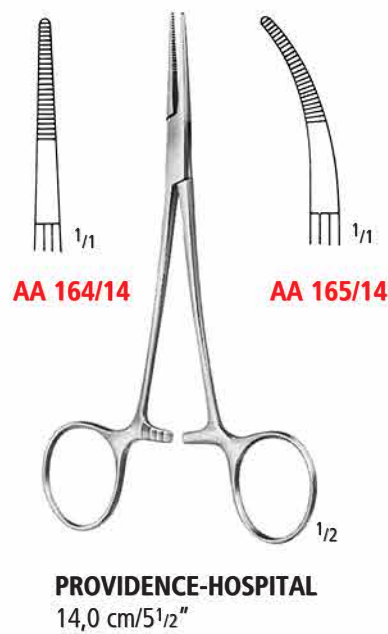
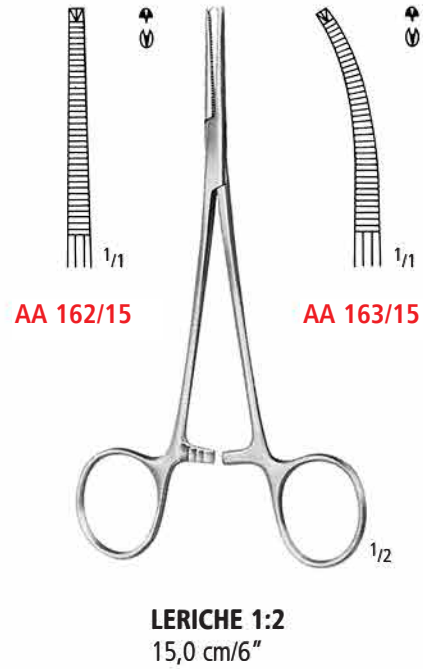
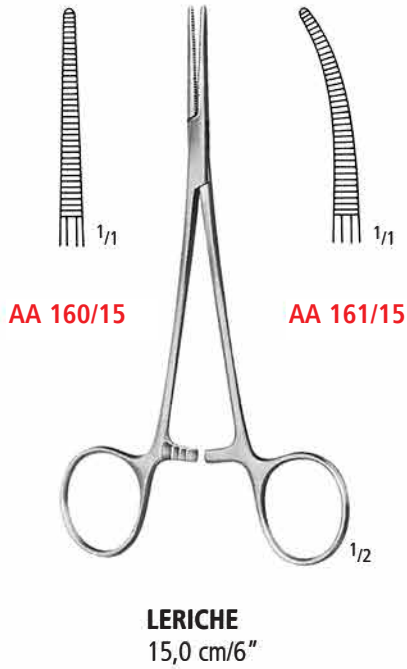



Arterienklemmen  
 Artery Forceps  
 Pinzas hemostáticas  
 Pincas hémostatiques  
 Pinze emostatiche

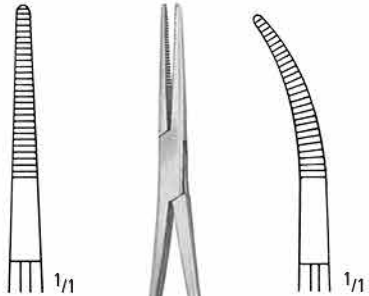

**AA 170/14**

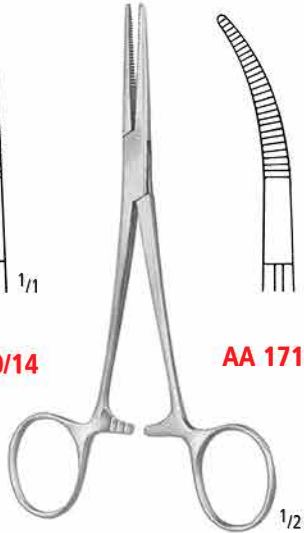

**KELLY**  
 14,0 cm/5 1/2"

**AA 171/14**

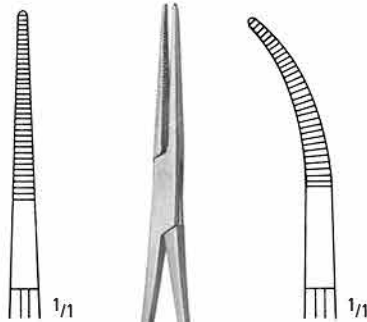

**AA 172/16**

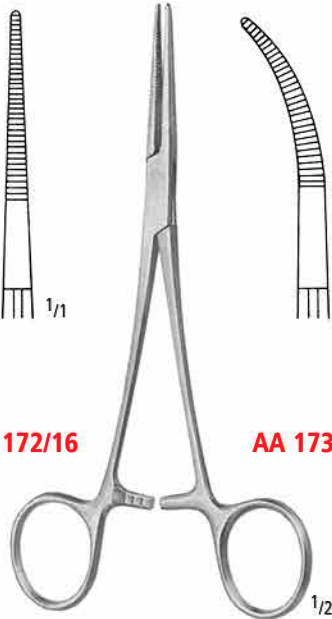

**KELLY-RANKIN**  
 16,0 cm/6 1/4"

**AA 173/16**

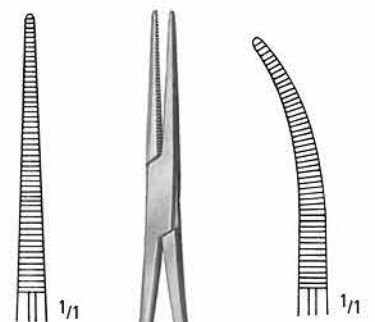

**AA 176/16**

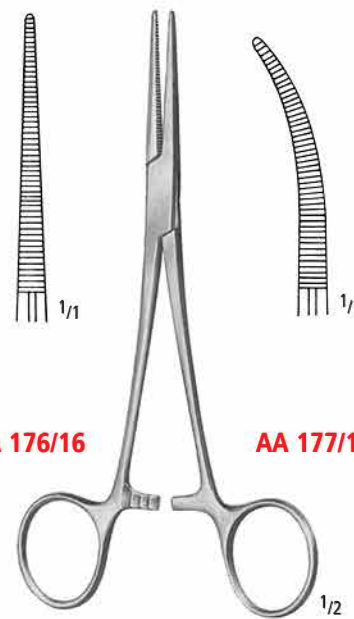

**COLLER**

**AA 176/14** 14,0 cm/5 1/2" **AA 177/14**  
**AA 176/16** 16,0 cm/6 1/4" **AA 177/16**

**AA 177/16**

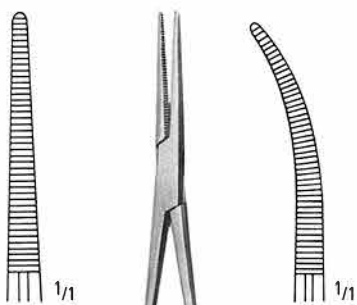

**AA 180/14**

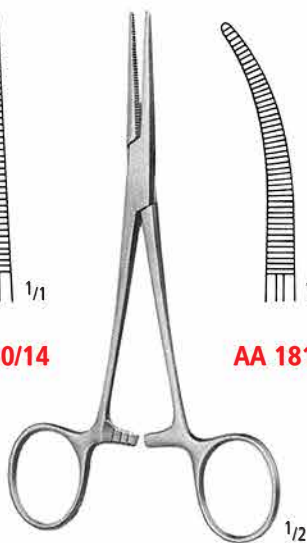

**CRILE**  
 14,0 cm/5 1/2"

**AA 181/14**

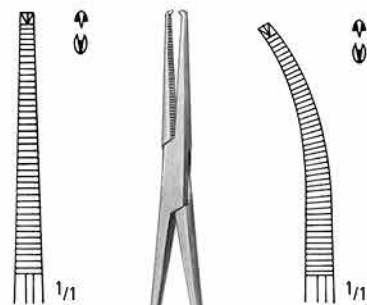

**AA 182/14**

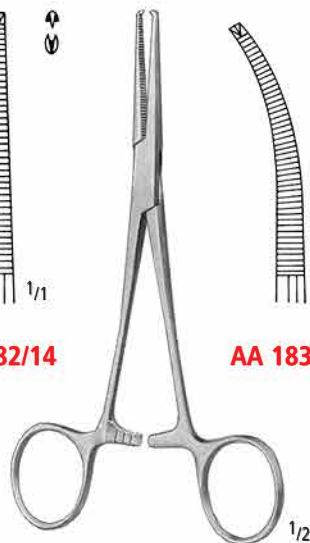

**CRILE 1:2**  
 14,0 cm/5 1/2"

**AA 183/14**

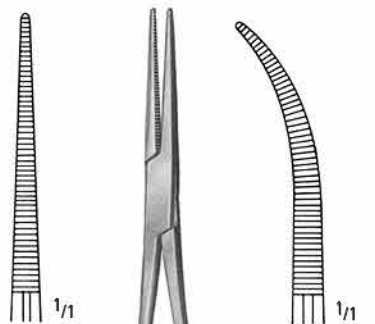

**AA 184/16**

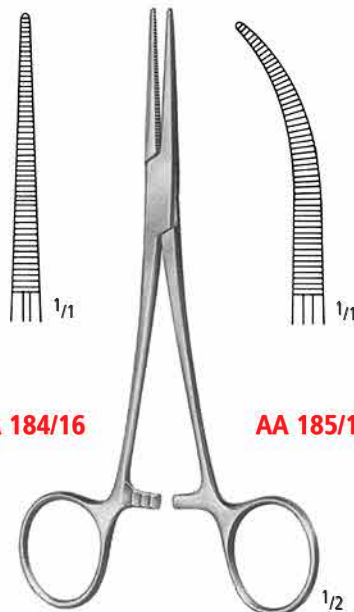

**CRILE-RANKIN**  
 16,0 cm/6 1/4"

**AA 185/16**

Arterienklemmen  
 Artery Forceps  
 Pinzas hemostáticas  
 Pincés hémostatiques  
 Pinze emostatiche

AA

AB

AC

AD

AE

AF

AK

AL

AO

AP

AR

KA

KL

KM

KO

KU

KYE

X



ROCHESTER-PEAN

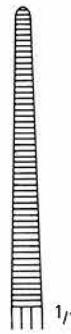

**AA 200/14**  
 14,0 cm/5 1/2"

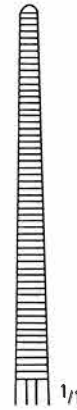

**AA 200/16**  
 16,0 cm/6 1/4"

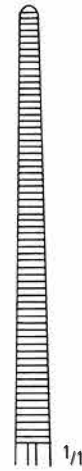

**AA 200/18**  
 18,0 cm/7"

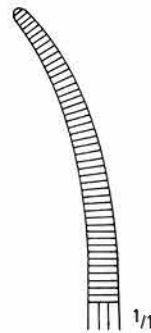

**AA 201/14**  
 14,0 cm/5 1/2"

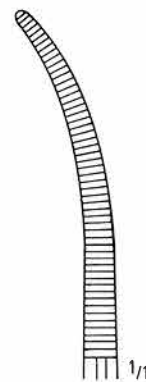

**AA 201/16**  
 16,0 cm/6 1/4"

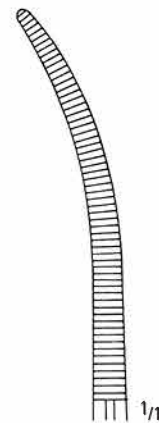

**AA 201/18**  
 18,0 cm/7"

Arterienklemmen  
 Artery Forceps  
 Pinzas hemostáticas  
 Pincas hémostatiques  
 Pinze emostatiche



OCHSNER-KOCHER 1:2

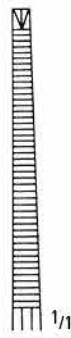

**AA 210/14**  
 14,0 cm/5 1/2"

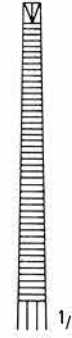

**AA 210/16**  
 16,0 cm/6 1/4"

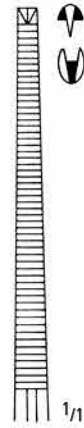

**AA 210/18**  
 18,0 cm/7"

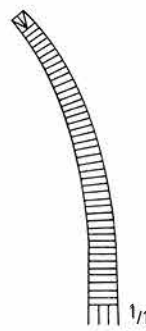

**AA 211/14**  
 14,0 cm/5 1/2"

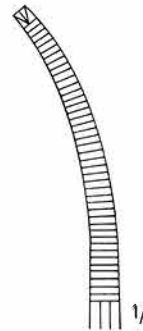

**AA 211/16**  
 16,0 cm/6 1/4"

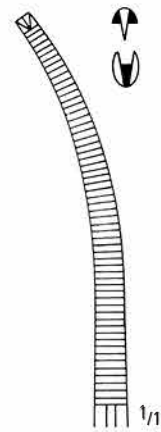

**AA 211/18**  
 18,0 cm/7"

Grazile Arterienklemmen  
 Delicate Artery Forceps  
 Pinzas hemostáticas delgadas  
 Pincés hémostatiques grâciles  
 Pinze emostatiche delicate

AA

AB

AC

AD

AE

AF

AK

AL

AO

AP

AR

KA

KL

KM

KO

KU

KYE

X

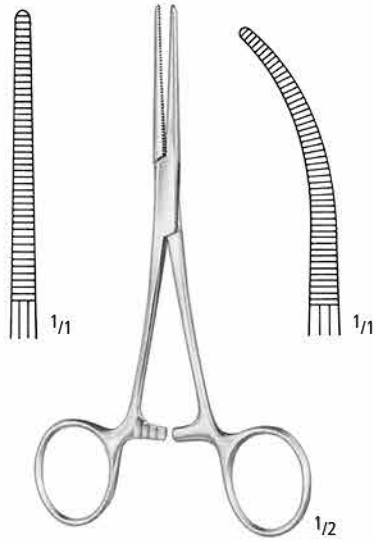

**PEAN - DELICATE**

- |                  |                  |
|------------------|------------------|
| <b>AA 214/13</b> | <b>AA 215/13</b> |
| <b>AA 214/14</b> | <b>AA 215/14</b> |
| <b>AA 214/16</b> | <b>AA 215/16</b> |

- 13,0 cm/5"  
 14,0 cm/5<sup>1</sup>/<sub>2</sub>"  
 16,0 cm/6<sup>1</sup>/<sub>4</sub>"

**JULES PEAN**, born 1830, died 1898, was the most important French gynecological surgeon of his time. He studied at Paris 1860. 1864 Pean was the first surgeon in Paris to perform an ovariectomy. By the use of Pean pins he introduced forceps pressure for control of hemorrhage, thus he invented the most used surgical instrument, next to the scalpel.

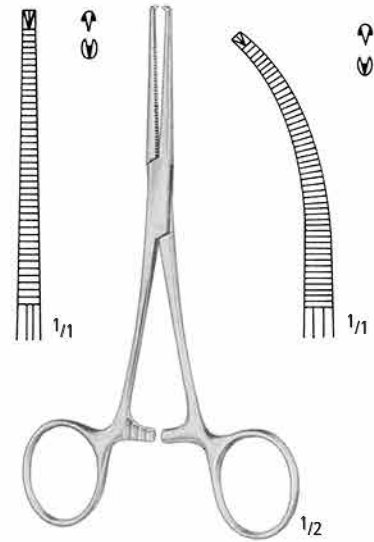

**KOCHER 1:2 - DELICATE**

- |                  |                  |
|------------------|------------------|
| <b>AA 216/13</b> | <b>AA 217/13</b> |
| <b>AA 216/14</b> | <b>AA 217/14</b> |
| <b>AA 216/16</b> | <b>AA 217/16</b> |

**ALBERT J. OCHSNER**, born 1858, died 1925. He devoted much time to attending and participating in medical discussions and was member of all leading societies in his fields.

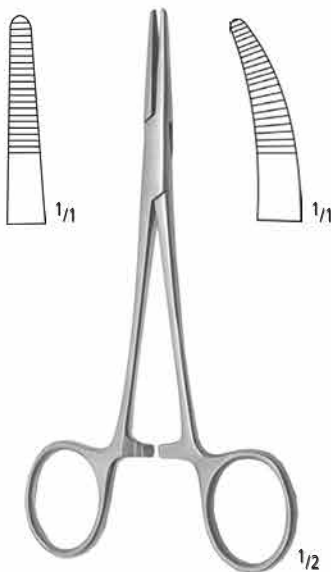

**CAIRNS**

- |                  |            |                  |
|------------------|------------|------------------|
| <b>AA 218/15</b> | 15,0 cm/6" | <b>AA 219/15</b> |
|------------------|------------|------------------|

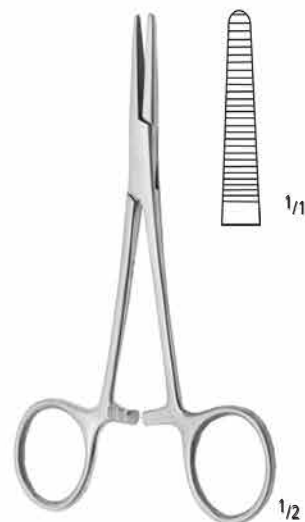

**DUNHILL**

- |                  |
|------------------|
| <b>AA 220/13</b> |
| 13,0 cm/5"       |

Arterienklemmen, Kopfhautklemmen  
 Artery Forceps, Scalp Flap Forceps  
 Pinzas hemostáticas, Pinzas hemostáticas para pericráneo  
 Pincés hémostatiques, Pincés hémostatiques pour le cuir chevelu  
 Pinze emostatiche, Pinze emostatiche per il cuoio capelluto

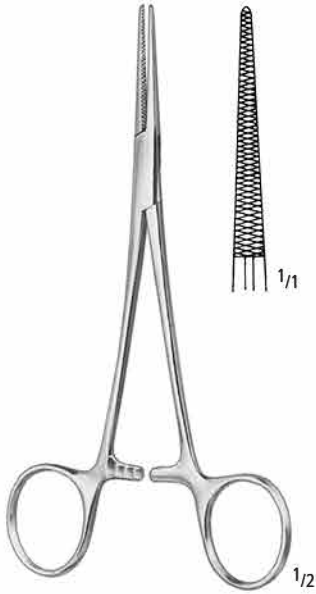

**DIXON-LOVELACE**  
**AA 286/15**  
 15,5 cm/6"



**DIXON-LOVELACE 1:2**  
**AA 288/15**  
 15,5 cm/6"

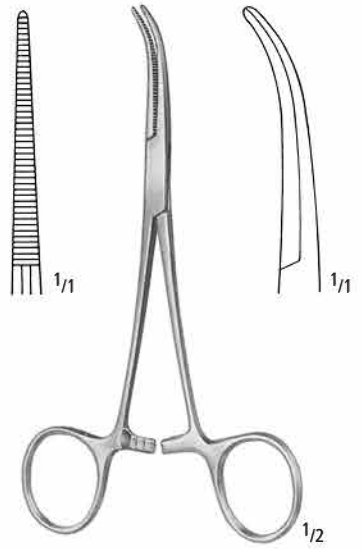

**DANDY**  
**AA 291/14**  
 14,0 cm/5 1/2"

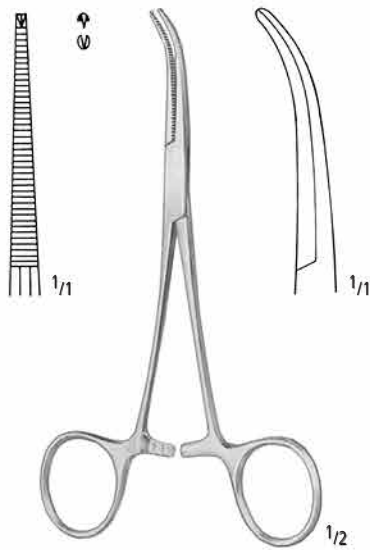

**DANDY 1:2**  
**AA 293/14**  
 14,0 cm/5 1/2"

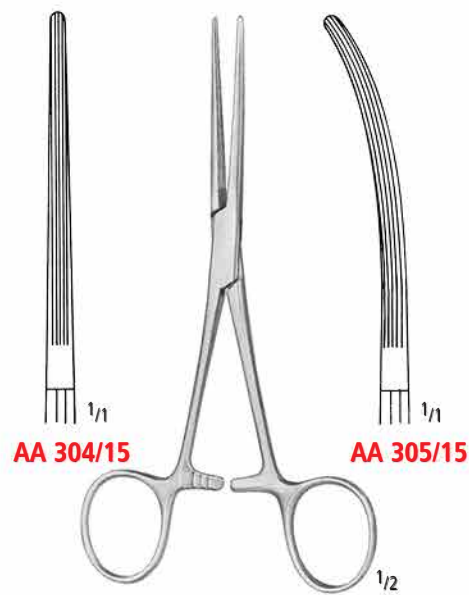

**AA 304/15**  
**AA 304/18**

**BAINBRIDGE**  
 15,0 cm/6"  
 18,5 cm/7 1/3"

**AA 305/15**  
**AA 305/18**



Präparier- und Ligaturklemmen  
 Dissecting and Ligature Forceps  
 Pinzas para preparaciones y ligaduras  
 Pincas à dissection et à ligatures  
 Pinze per preparazioni e legature

AA

AB

AC

AD

AE

AF

AK

AL

AO

AP

AR

KA

KL

KM

KO

KU

KYE

X

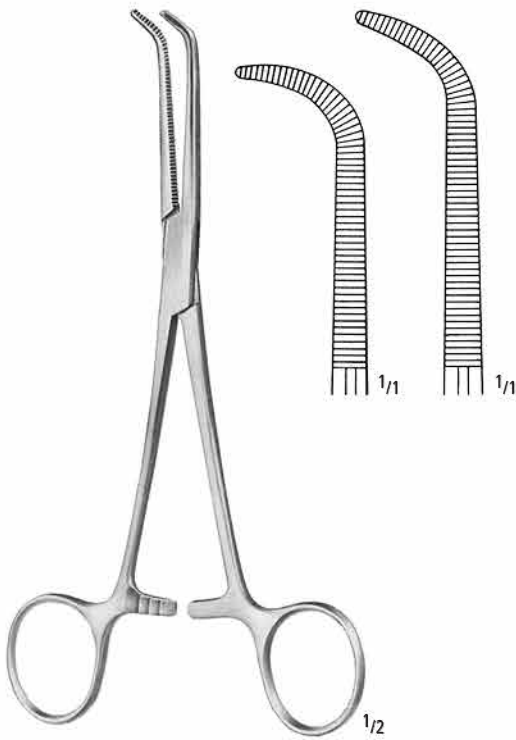

**MIXTER**  
 15,5 cm/6"  
 19,0 cm/7 1/2"  
**AA 345/15**  
**AA 345/19**

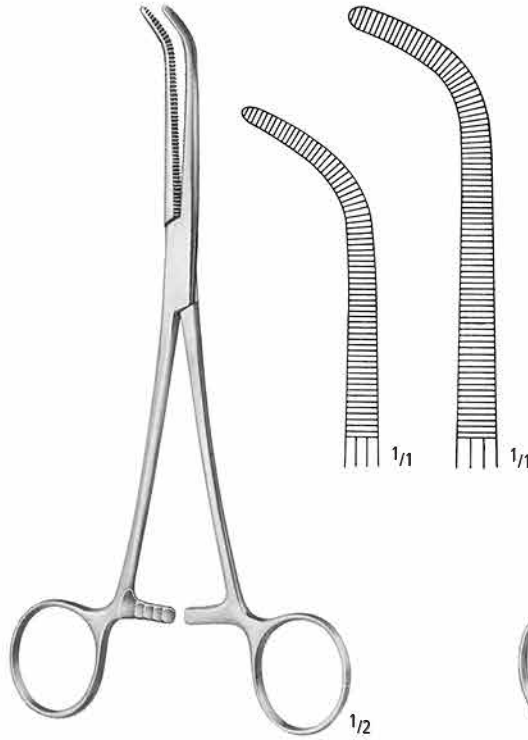

**MIXTER-O'SHAUGNESSY**  
 15,5 cm/6"  
 19,0 cm/7 1/2"  
**AA 347/15**  
**AA 347/19**

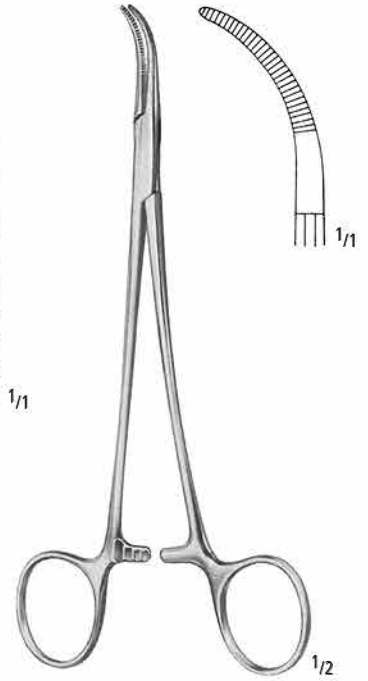

**BABY-MIXTER**  
**AA 348/18**  
 18,0 cm/7"

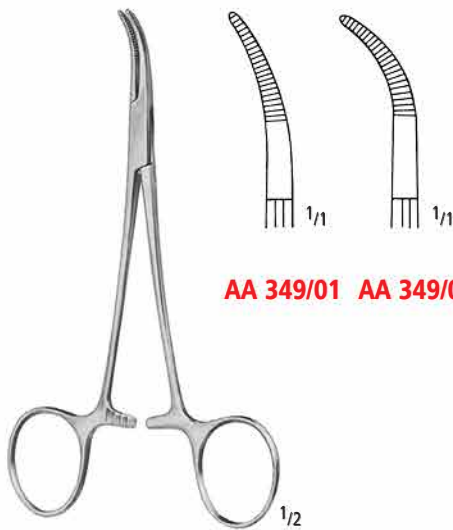

**AA 349/01 AA 349/02**

**BABY-MIXTER**  
 14,0 cm/5 1/2"

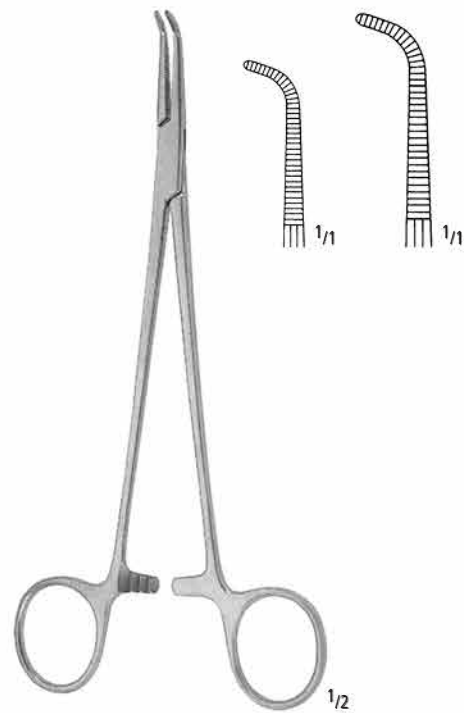

**GEMINI**  
 14,0 cm/5 1/2"  
 18,0 cm/7"  
**AA 365/14**  
**AA 365/18**

Tuchklemmen  
Towel Forceps  
Pinzas de campo  
Pinces à champs  
Pinze per fissare le compresse (Fissatele)



**SCHAEDEL**  
**AA 710/09**  
9,0 cm/3 1/2"



**JONES**  
5,0 cm/2"  
9,0 cm/3 1/2" **AA 711/05**  
**AA 711/09**



**ENGL. MODELL**  
**AA 717/09**  
9,0 cm/3 1/2"



**DOYEN**  
**AA 721/18**  
18,0 cm/7"



**BERNHARD**  
**AA 726/16**  
16,5 cm/6 1/2"



**LANE**  
15,0 cm/6"  
18,0 cm/7"  
20,0 cm/8" **AA 730/15**  
**AA 730/18**  
**AA 730/20**

Tuchklemmen  
Towel Forceps  
Pinzas para compresas, Pinzas de campo  
Pinces à champs, Pinces à compresses  
Pinze per fissare le compresse (Fissatele)

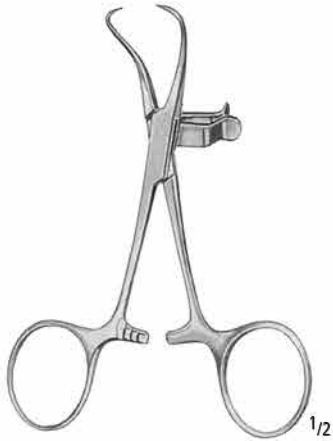

**AA 749/11**

11,0 cm/4<sup>1</sup>/<sub>3</sub>"

- mit Schlauch- oder Kabelhalter
- with clip for tubing or cable
- con porta-tubo o porta-cable
- avec clamp porte-tube ou porte-corton d'alimentation
- con porta tubo o porta cavo

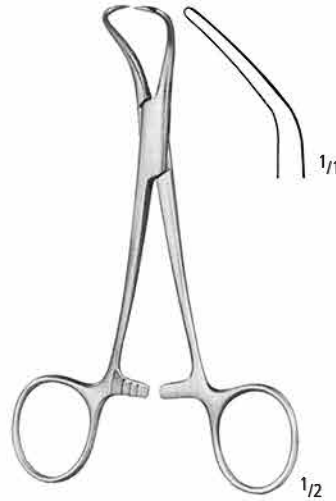

**BACKHAUS**

8,0 cm/3"

11,0 cm/4<sup>1</sup>/<sub>3</sub>"

13,0 cm/5"

15,0 cm/6"

**AA 751/08**

**AA 751/11**

**AA 751/13**

**AA 751/15**

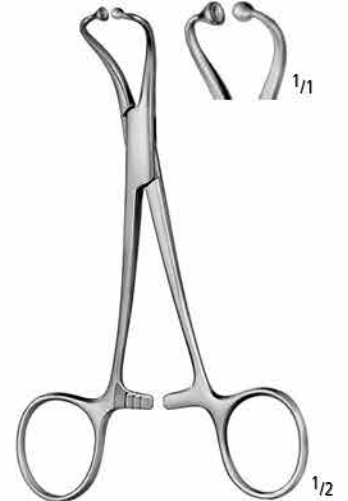

**BALL & SOCKET**

11,0 cm/4<sup>1</sup>/<sub>3</sub>"

13,0 cm/5"

**AA 753/11**

**AA 753/13**

für Papiertücher  
for paper tissues  
para servilletas de papel  
pour serviettes en papier  
per tessuti di carta



**ROEDER**

13,0 cm/5"

**AA 761/13**

15,0 cm/6"

**AA 761/15**

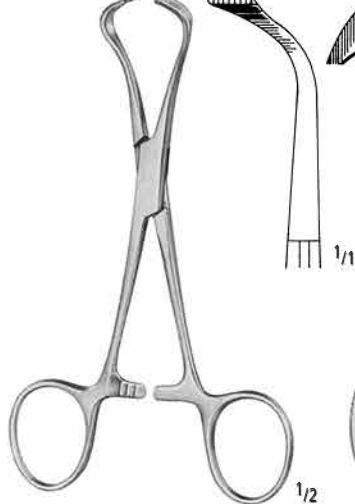

**LORNA**

10,0 cm/4"

**AA 763/10**

13,0 cm/5"

**AA 763/13**

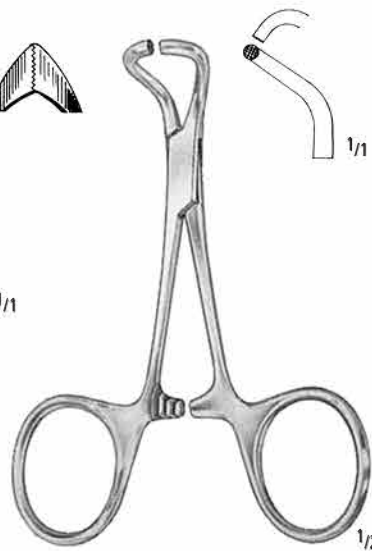

**TOHOKU-JAPAN**

10,0 cm/4"

**AA 764/10**

13,0 cm/5"

**AA 764/13**

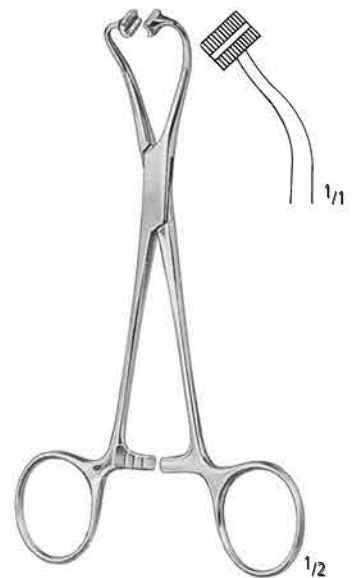

**PEERS**

**AA 765/14**

14,5 cm/5<sup>3</sup>/<sub>4</sub>"

AA  
AB  
AC  
AD  
AE  
AF  
AG  
AH  
AI  
AJ  
AK  
AL  
AM  
AN  
AO  
AP  
AQ  
AR  
AS  
AT  
AU  
AV  
AW  
AX  
AY  
AZ

Schlauchklemmen  
Tubing Clamps  
Pinzas para tubos  
Presses-tube  
Pinze serratubi

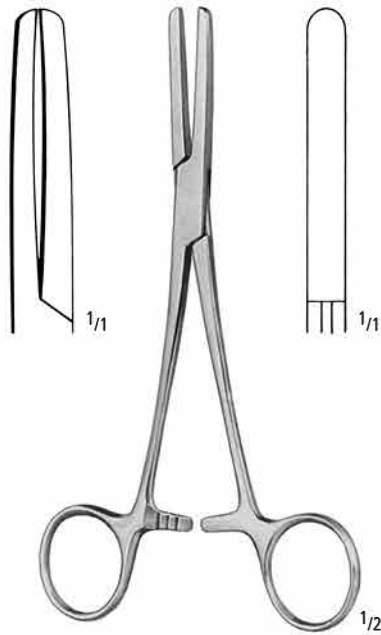

**PRESBYTERIAN**  
16,5 cm/6<sup>1</sup>/<sub>2</sub>" **AA 790/16**  
18,0 cm/7" **AA 790/18**

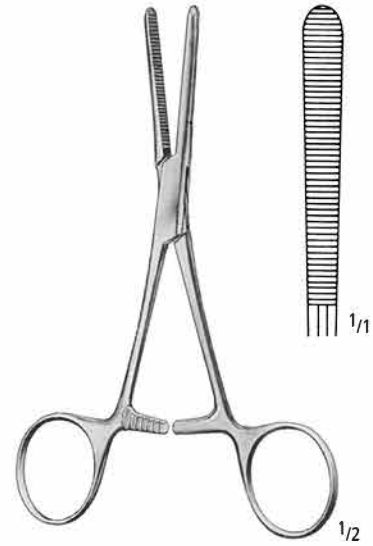

**KLINIKUM BERLIN**  
**AA 792/14**  
14,5 cm/5<sup>3</sup>/<sub>4</sub>"  
mit langer Sperre  
with long ratchet  
con cremallera larga  
à crémaillère extra longue  
con cremagliera extra lunga

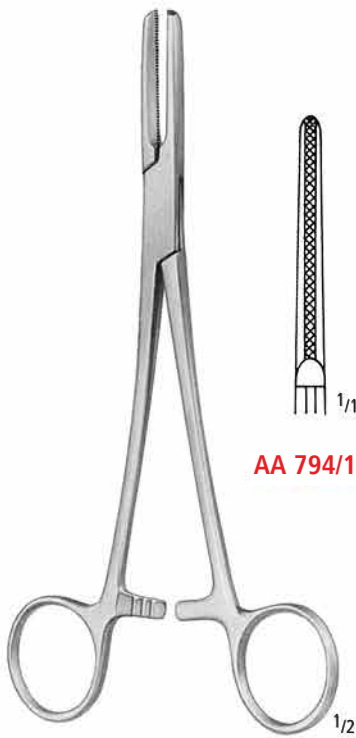

**AA 794/15**

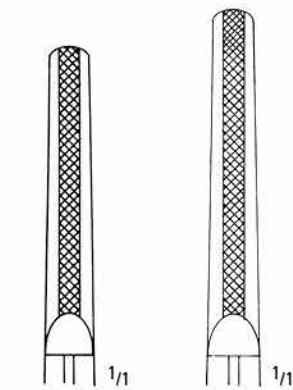

**AA 794/18**

**AA 794/20**

**AA 794/15**  
**AA 794/18**  
**AA 794/20**

15,5 cm/6"  
18,0 cm/7"  
20,0 cm/8"

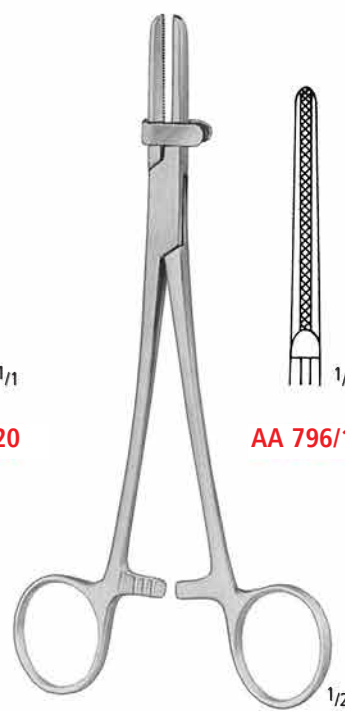

**AA 796/15**

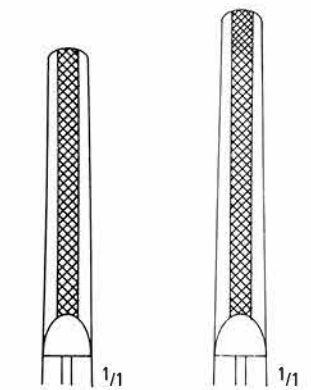

**AA 796/18**

**AA 796/20**

**AA 796/15**  
**AA 796/18**  
**AA 796/20**

PINZETTEN

FORCEPS

PINZAS

PINCES

PINZE

AB

nopa<sup>®</sup> instruments

Weitere Pinzetten finden Sie in unserem Katalog „Allgemeines Instrumentarium“ in Gruppe AB.

For further forceps kindly refer to our catalogue „General Instruments“, section AB.

Para pinzas adicionales, por favor consulte nuestro catálogo de „Instrumental de uso general“, grupo AB.

Pour des pinces supplémentaires, consultez notre catalogue „Instrumentation Generale“, section AB.

Per gli altri pinze, consultare il nostro catalogo „Strumentazione Generale“, gruppo AB.





**AB** PINZETTEN FORCEPS PINZAS PINCES PINZE

Anatomische Pinzetten, Chirurgische Pinzetten  
 Dressing Forceps, Tissue Forceps  
 Pinzas de disección, Pinzas de disección con dientes  
 Pincés à dissection, Pincés à griffes  
 Pinze anatomiche per dissezione, Pinze chirurgiche a denti di topo



**STANDARD**

	2,2 mm	2,8 mm	3,0 mm	3,2 mm	3,4 mm	3,6 mm	3,6 mm
	<b>AB 050/10</b>	<b>AB 050/11</b>	<b>AB 050/13</b>	<b>AB 050/14</b>	<b>AB 050/16</b>	<b>AB 050/18</b>	<b>AB 050/20</b>
				10,5 cm/4 <sup>1</sup> / <sub>4</sub> "	<b>AB 050/10</b>		
				11,5 cm/4 <sup>1</sup> / <sub>2</sub> "	<b>AB 050/11</b>		
				13,0 cm/5"	<b>AB 050/13</b>		
				14,5 cm/5 <sup>3</sup> / <sub>4</sub> "	<b>AB 050/14</b>		
				16,0 cm/6 <sup>1</sup> / <sub>4</sub> "	<b>AB 050/16</b>		
				18,0 cm/7"	<b>AB 050/18</b>		
				20,0 cm/8"	<b>AB 050/20</b>		



**1:2 STANDARD**

	2,4 mm	2,5 mm	2,6 mm	2,8 mm	3,4 mm	3,4 mm	3,6 mm
	<b>AB 060/10</b>	<b>AB 060/11</b>	<b>AB 060/13</b>	<b>AB 060/14</b>	<b>AB 060/16</b>	<b>AB 060/18</b>	<b>AB 060/20</b>
				10,5 cm/4 <sup>1</sup> / <sub>4</sub> "	<b>AB 060/10</b>		
				11,5 cm/4 <sup>1</sup> / <sub>2</sub> "	<b>AB 060/11</b>		
				13,0 cm/5"	<b>AB 060/13</b>		
				14,5 cm/5 <sup>3</sup> / <sub>4</sub> "	<b>AB 060/14</b>		
				16,0 cm/6 <sup>1</sup> / <sub>4</sub> "	<b>AB 060/16</b>		
				18,0 cm/7"	<b>AB 060/18</b>		
				20,0 cm/8"	<b>AB 060/20</b>		

PINZETTEN FORCEPS PINZAS PINCES PINZE

Anatomische Pinzetten, Chirurgische Pinzetten  
 Dressing Forceps, Tissue Forceps  
 Pinzas de disección, Pinzas de disección con dientes  
 Pincers à dissection, Pincers à griffes  
 Pinze anatomiche per dissezione, Pinze chirurgiche a denti di topo

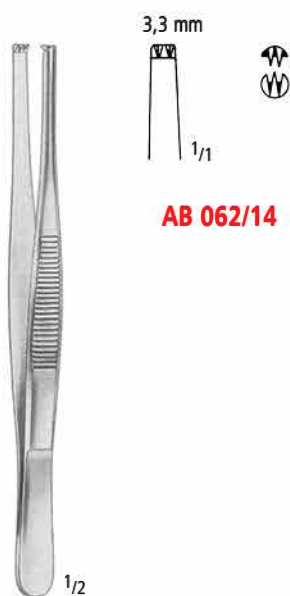

**AB 062/14**

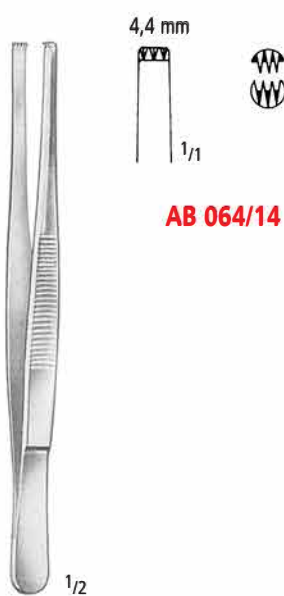

**AB 064/14**

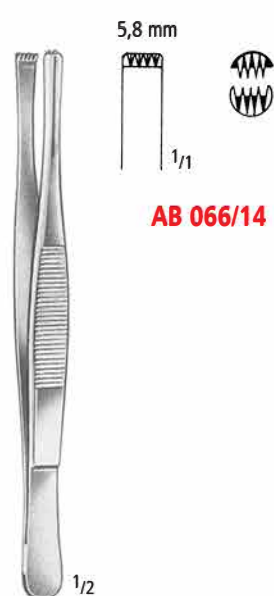

**AB 066/14**

**2:3**

**3:4**

**4:5**

- 13,0 cm/5" **AB 062/13**
- 14,5 cm/5<sup>3</sup>/<sub>4</sub>" **AB 062/14**
- 16,0 cm/6<sup>1</sup>/<sub>4</sub>" **AB 062/16**
- 18,0 cm/7" **AB 062/18**
- 20,0 cm/8" **AB 062/20**

- AB 064/13**
- AB 064/14**
- AB 064/16**

- AB 066/13**
- AB 066/14**
- AB 066/16**

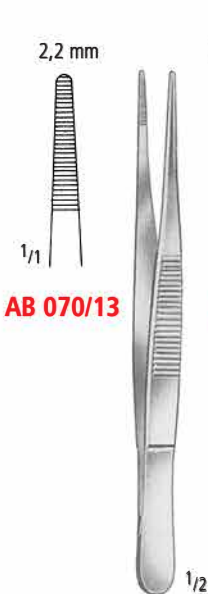

**AB 070/13**

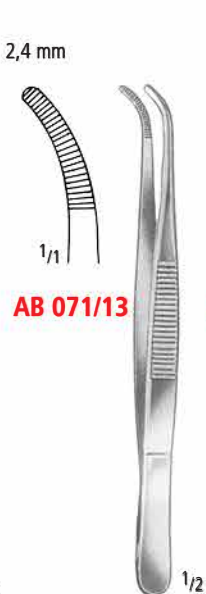

**AB 071/13**

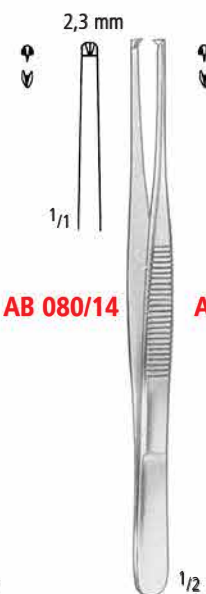

**AB 080/14**



**AB 081/14**

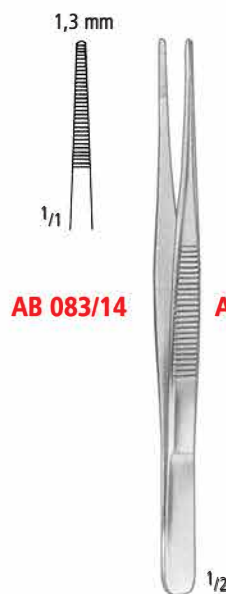

**AB 083/14**

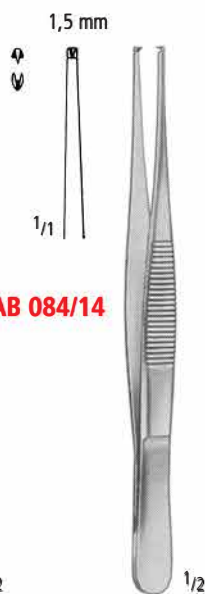

**AB 084/14**

**1:2**

**1:2**

**1:2**

schmal - narrow - estrechas - étroites - strette

fein - delicate - finas - fines - fine

- 10,5 cm/4<sup>1</sup>/<sub>4</sub>" **AB 070/10**
- 11,5 cm/4<sup>1</sup>/<sub>2</sub>" **AB 070/11**
- 13,0 cm/5" **AB 070/13**
- 14,5 cm/5<sup>3</sup>/<sub>4</sub>" **AB 070/14**
- 16,0 cm/6<sup>1</sup>/<sub>4</sub>" **AB 070/16**
- 18,0 cm/7" **AB 070/18**
- 20,0 cm/8" **AB 070/20**

- AB 071/10**
- AB 071/11**
- AB 071/13**
- AB 071/14**
- AB 071/16**
- AB 071/18**
- AB 071/20**

- AB 080/10**
- AB 080/11**
- AB 080/13**
- AB 080/14**
- AB 080/16**
- AB 080/18**
- AB 080/20**

- AB 081/10**
- AB 081/11**
- AB 081/13**
- AB 081/14**
- AB 081/16**
- AB 081/18**
- AB 081/20**

- AB 083/13**
- AB 083/14**

- AB 084/13**
- AB 084/14**

**AB** PINZETTEN FORCEPS PINZAS PINCES PINZE

Anatomische Pinzetten, Chirurgische Pinzetten  
 Dressing Forceps, Tissue Forceps  
 Pinzas de disección, Pinzas de disección con dientes  
 Pincés à dissection, Pincés à griffes  
 Pinze anatomiche per dissezione, Pinze chirurgiche a denti di topo

**MODELL USA**

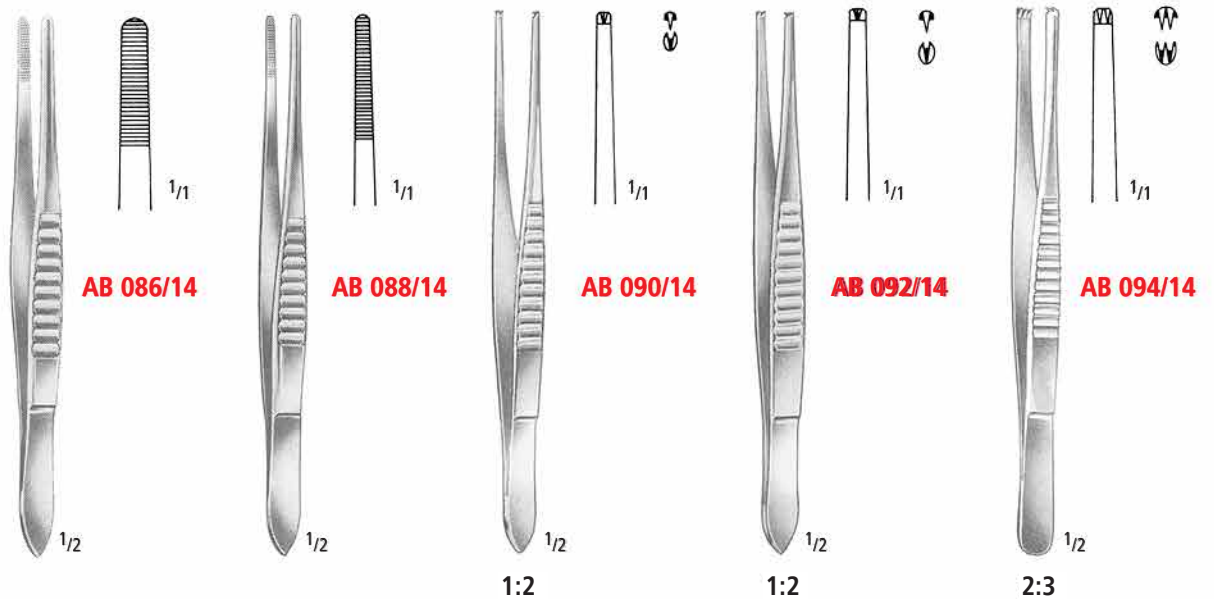

schmal - narrow - estrechas - étroites - strette

12,0 cm/4 <sup>3</sup> / <sub>4</sub> "	<b>AB 086/12</b>	<b>AB 088/12</b>		<b>AB 092/12</b>	<b>AB 094/12</b>
13,0 cm/5"	<b>AB 086/13</b>	<b>AB 088/13</b>	<b>AB 090/13</b>	<b>AB 092/13</b>	<b>AB 094/13</b>
14,5 cm/5 <sup>3</sup> / <sub>4</sub> "	<b>AB 086/14</b>	<b>AB 088/14</b>	<b>AB 090/14</b>	<b>AB 092/14</b>	<b>AB 094/14</b>
15,5 cm/6"	<b>AB 086/15</b>	<b>AB 088/15</b>	<b>AB 090/15</b>	<b>AB 092/15</b>	<b>AB 094/15</b>
18,0 cm/7"	<b>AB 086/18</b>			<b>AB 092/18</b>	<b>AB 094/18</b>

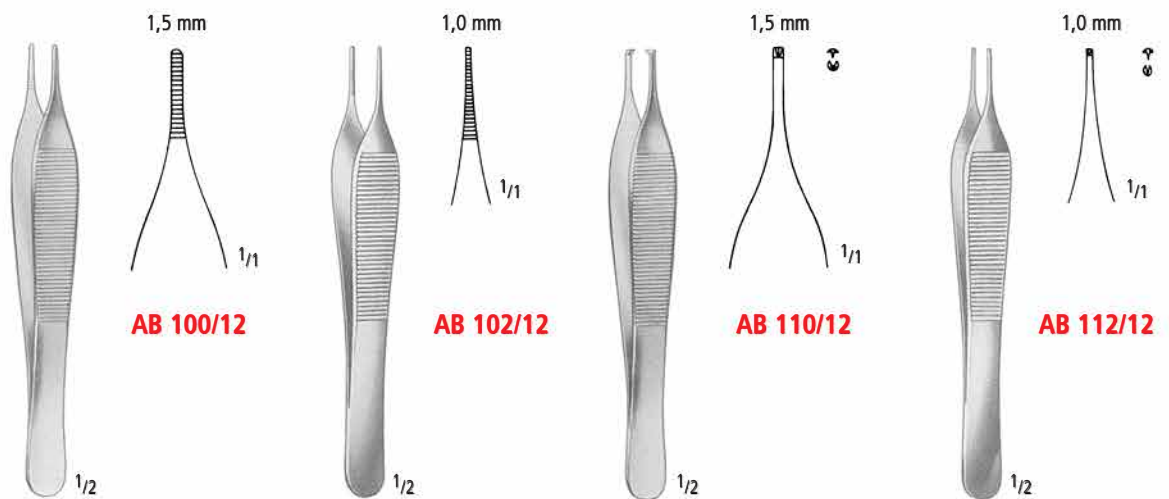

12,0 cm/4 <sup>3</sup> / <sub>4</sub> "	<b>ADSON</b>	<b>MICRO-ADSON</b>	<b>ADSON 1:2</b>	<b>MICRO-ADSON 1:2</b>
15,0 cm/6"	<b>AB 100/12</b>	<b>AB 102/12</b>	<b>AB 110/12</b>	<b>AB 112/12</b>
	<b>AB 100/15</b>	<b>AB 102/15</b>	<b>AB 110/15</b>	<b>AB 112/15</b>

PINZETTES FORCEPS PINZAS PINCES PINZE

Anatomische Pinzetten, Chirurgische Pinzetten  
 Dressing Forceps, Tissue Forceps  
 Pinzas de disección, Pinzas de disección con dientes  
 Pincers à dissection, Pincers à griffes  
 Pinze anatomiche per dissezione, Pinze chirurgiche a denti di topo

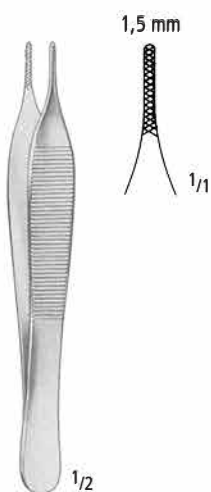

**ADSON**  
**AB 114/12**  
 12,0 cm/4<sup>3</sup>/<sub>4</sub>"

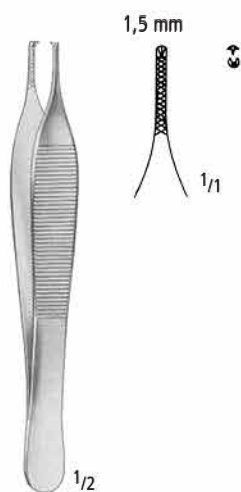

**ADSON 1:2**  
**AB 115/12**  
 12,0 cm/4<sup>3</sup>/<sub>4</sub>"



**ADSON-BROWN**  
 12,0 cm/4<sup>3</sup>/<sub>4</sub>"

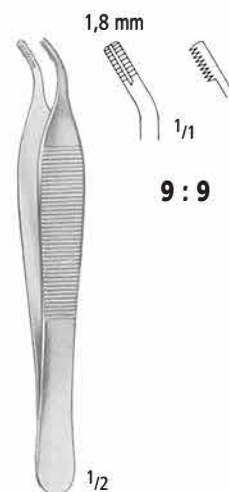

**ADSON-BROWN**  
**AB 117/09**  
 12,0 cm/4<sup>3</sup>/<sub>4</sub>"

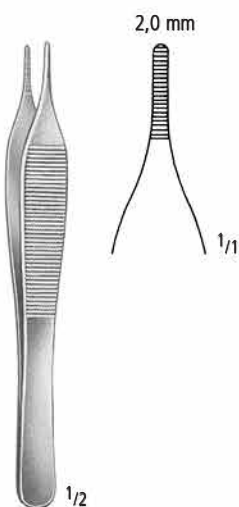

**EWALD**  
**AB 118/01**  
 12,0 cm/4<sup>3</sup>/<sub>4</sub>"

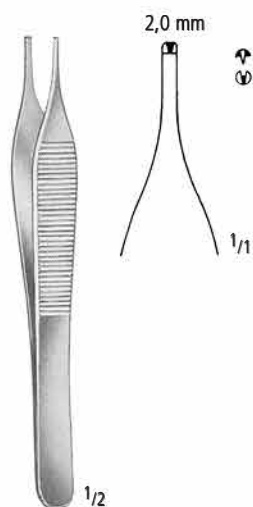

**EWALD 1:2**  
**AB 118/02**  
 12,0 cm/4<sup>3</sup>/<sub>4</sub>"

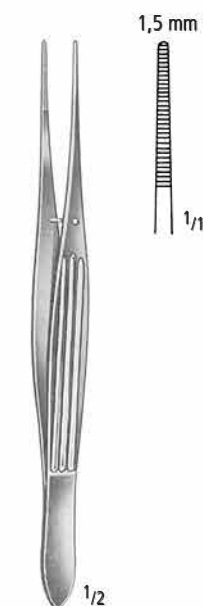

**McINDOE**  
**AB 119/15**  
 15,0 cm/6"



**AB 120/12**  
**AB 120/15**



**SEMKEN**  
 12,5 cm/5"  
**AB 121/12**  
 15,5 cm/6"  
**AB 121/15**

AA  
 AB  
 AC  
 AD  
 AE  
 AF  
 AG  
 AH  
 AI  
 AJ  
 AK  
 AL  
 AM  
 AN  
 AO  
 AP  
 AQ  
 AR  
 AS  
 AT  
 AU  
 AV  
 AW  
 AX



**AB** PINZETTEN FORCEPS PINZAS PINCES PINZE

Anatomische Pinzetten, Chirurgische Pinzetten  
 Dressing Forceps, Tissue Forceps  
 Pinzas de disección, Pinzas de disección con dientes  
 Pincers à dissection, Pincers à griffes  
 Pinze anatomiche per dissezione, Pinze chirurgiche a denti di topo

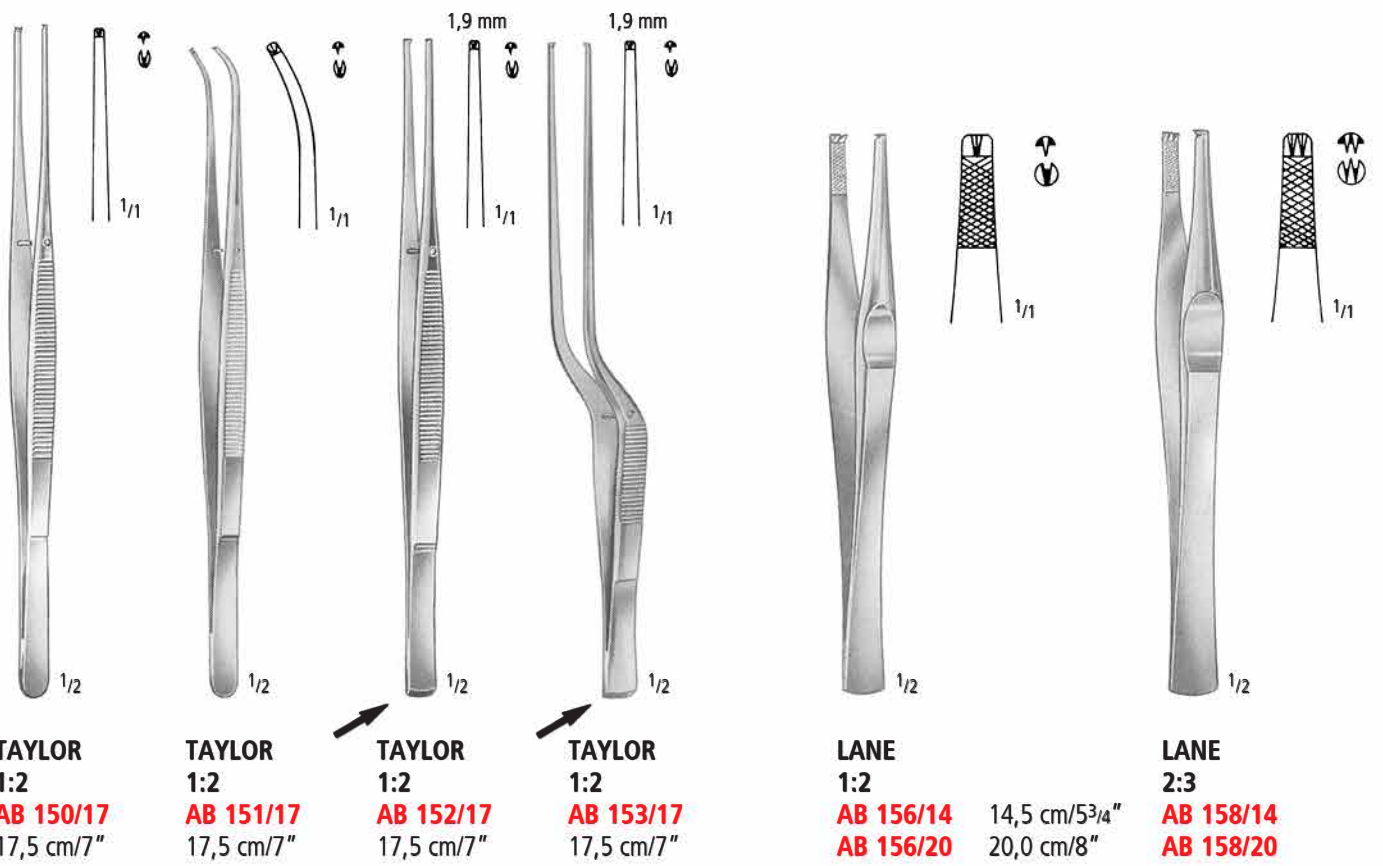
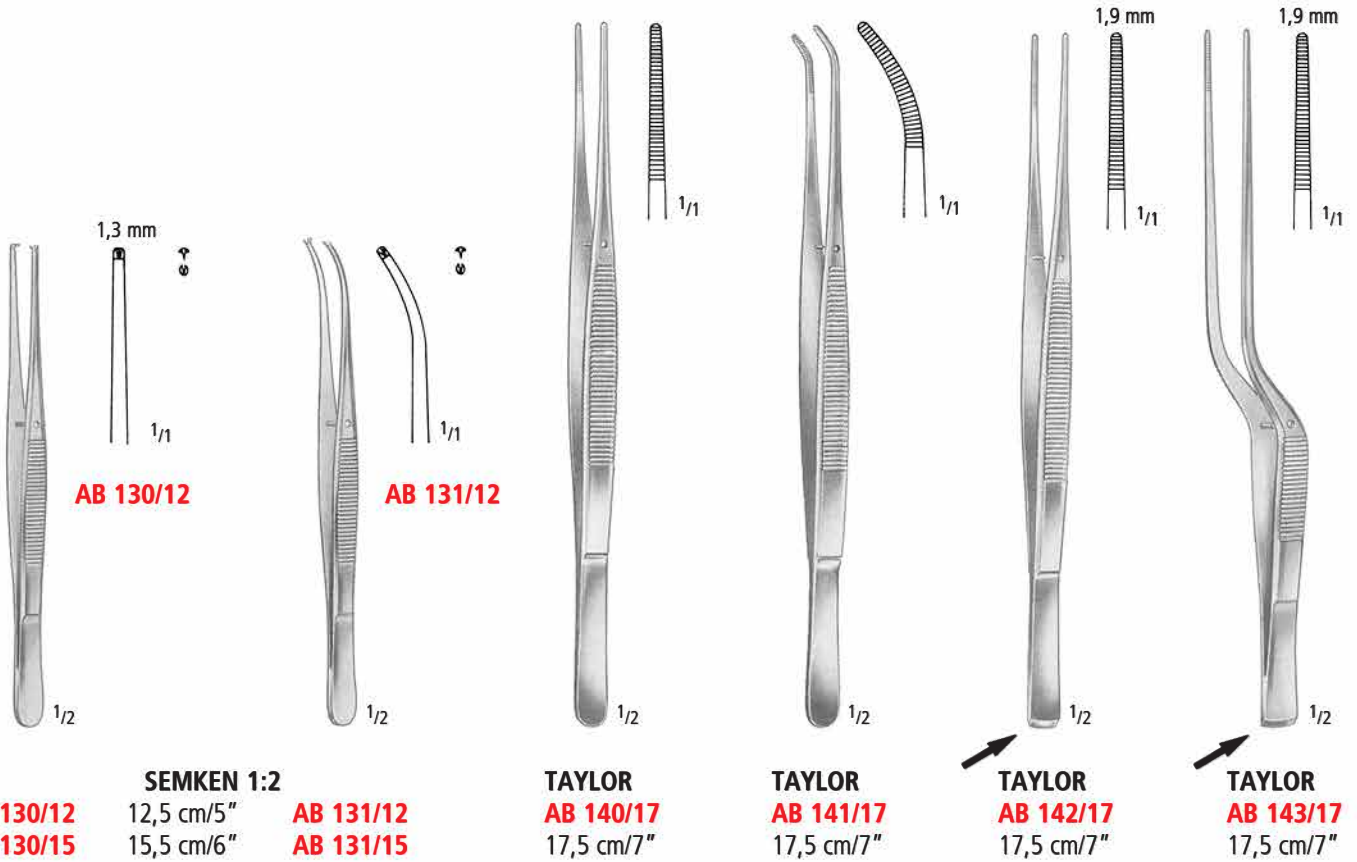



PINZETTEN FORCEPS PINZAS PINCES PINZE

Anatomische Pinzetten, Chirurgische Pinzetten  
 Dressing Forceps, Tissue Forceps  
 Pinzas de disección, Pinzas de disección con dientes  
 Pincers à dissection, Pincers à griffes  
 Pinze anatomiche per dissezione, Pinze chirurgiche a denti di topo

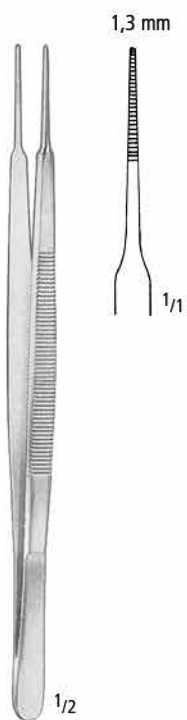

**GERALD**  
**AB 160/18**

18,0 cm/7"

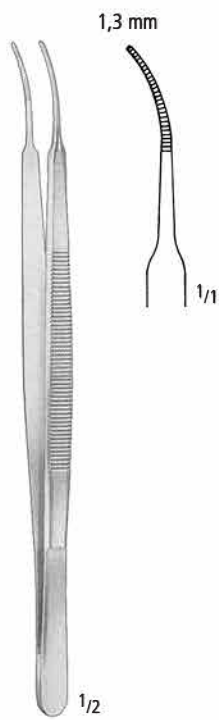

**GERALD**  
**AB 161/18**

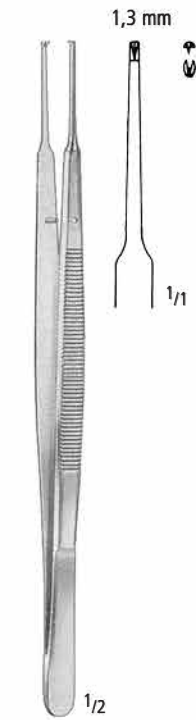

**GERALD 1:2**  
**AB 170/18**

18,0 cm/7"



**GERALD 1:2**  
**AB 171/18**

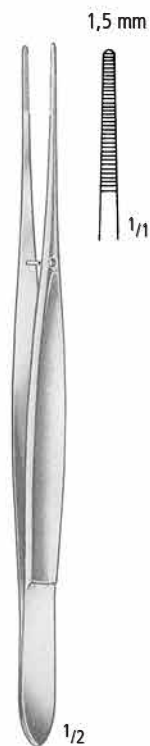

**CUSHING**  
**AB 180/17**

17,5 cm/7"



**CUSHING**  
**AB 181/17**



**CUSHING 1:2**  
**AB 190/17**

17,5 cm/7"



**CUSHING 1:2**  
**AB 191/17**

AA  
 AB  
 AC  
 AD  
 AE  
 AF  
 AG  
 AH  
 AI  
 AJ  
 AK  
 AL  
 AM  
 AN  
 AO  
 AP  
 AQ  
 AR  
 AS  
 AT  
 AU  
 AV  
 AW  
 AX

**AB** PINZETTEN FORCEPS PINZAS PINCES PINZE

Anatomische Pinzetten, Chirurgische Pinzetten  
 Dressing Forceps, Tissue Forceps  
 Pinzas de disección, Pinzas de disección con dientes  
 Pincers à dissection, Pincers à griffes  
 Pinze anatomiche per dissezione, Pinze chirurgiche a denti di topo

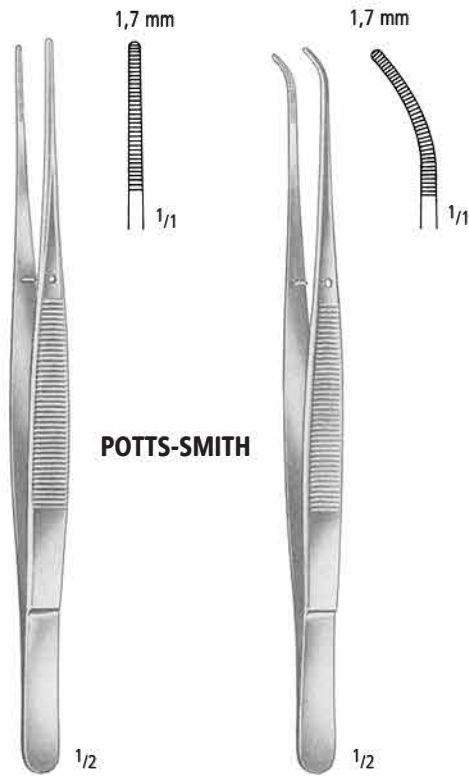

**POTTS-SMITH**

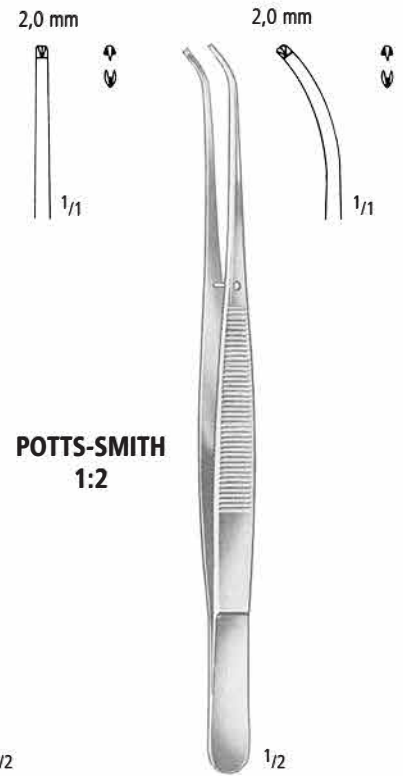

**POTTS-SMITH  
1:2**

18,0 cm/7"

**AB 200/18**

**AB 201/18**

**AB 210/18**

**AB 211/18**

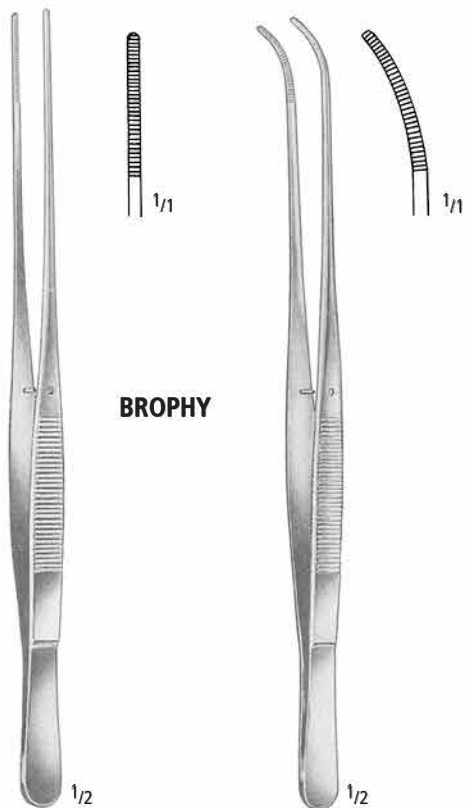

**BROPHY**

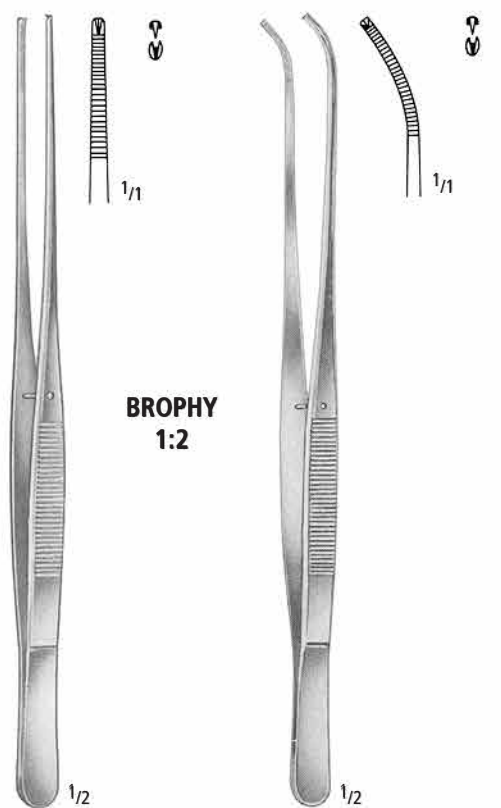

**BROPHY  
1:2**

20,0 cm/8"

**AB 250/20**

**AB 251/20**

**AB 260/20**

**AB 261/20**

PINZETTEN FORCEPS PINZAS PINCES PINZE

Anatomische Pinzetten, Chirurgische Pinzetten  
 Dressing Forceps, Tissue Forceps  
 Pinzas de disección, Pinzas de disección con dientes  
 Pincés à dissection, Pincés à griffes  
 Pinze anatomiche per dissezione, Pinze chirurgiche a denti di topo

AA  
 AB  
 AC  
 AD  
 AE  
 AF  
 AK  
 AL  
 AO  
 AP  
 AR  
 KA  
 KL  
 KM  
 KO  
 KU  
 KYE  
 X

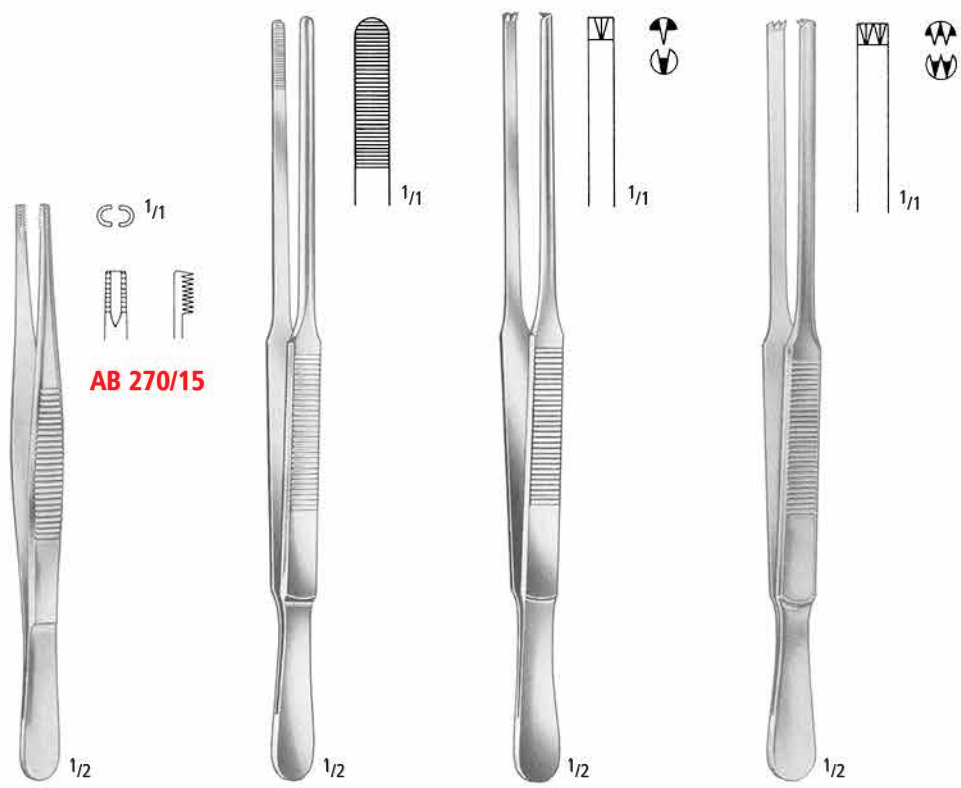

	<b>BROWN</b>	<b>DUEHRSSSEN</b>	<b>DUEHRSSSEN 1:2</b>	<b>DUEHRSSSEN 2:3</b>
15,0 cm/6"	<b>AB 270/15</b>	<b>AB 290/20</b>	<b>AB 292/20</b>	<b>AB 294/20</b>
20,0 cm/8"	<b>AB 270/20</b>			

**AB** PINZETTEN FORCEPS PINZAS PINCES PINZE

Anatomische Pinzetten, Chirurgische Pinzetten  
 Dressing Forceps, Tissue Forceps  
 Pinzas de disección, Pinzas de disección con dientes  
 Pincers à dissection, Pincers à griffes  
 Pinze anatomiche per dissezione, Pinze chirurgiche a denti di topo



**AB 316/20**

**STILLE-BARRAYA 3:4**  
 18,0 cm/7" **AB 316/18**  
 20,0 cm/8" **AB 316/20**

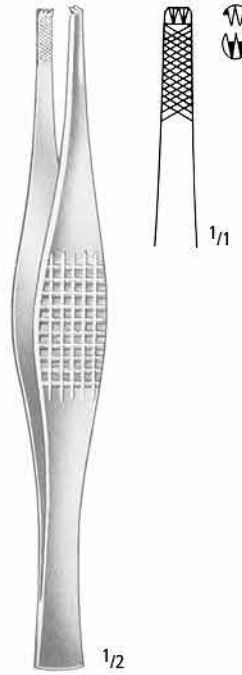

**FERRIS-SMITH 2:3**  
**AB 320/18**  
 18,0 cm/7"

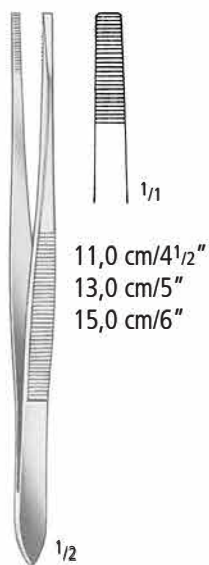

11,0 cm/4 1/2"  
 13,0 cm/5"  
 15,0 cm/6"

**STILLE**  
**AB 370/11**  
**AB 370/13**  
**AB 370/15**



**STILLE 1:2**  
**AB 380/15**  
 15,0 cm/6"



**STILLE 2:3**  
**AB 382/15**  
 15,0 cm/6"

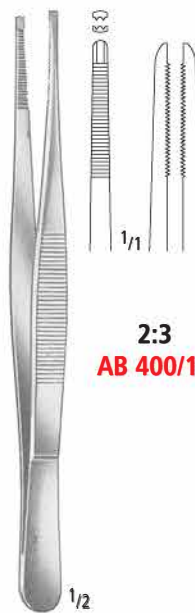

**2:3**  
**AB 400/15**

15,0 cm/6"  
 20,0 cm/8" **AB 400/20**



**4:5**  
**AB 404/15**

**ADLERKREUTZ**  
**AB 404/15**  
**AB 404/20**

PINZETTEN FORCEPS PINZAS PINCES PINZE

Chirurgische Pinzetten, Fasspinzetten  
 Tissue Forceps, Grasping Forceps  
 Pinzas de disección con dientes, Pinzas para coger  
 Pincers à griffes, Pincers pour saisir les tissus  
 Pinze chirurgiche a denti di topo, Pinze per afferrare tessuti

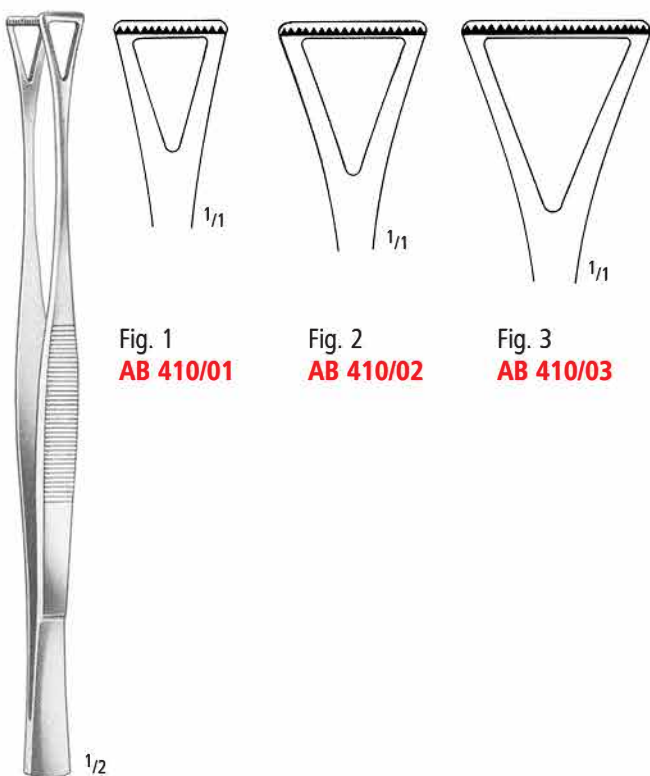
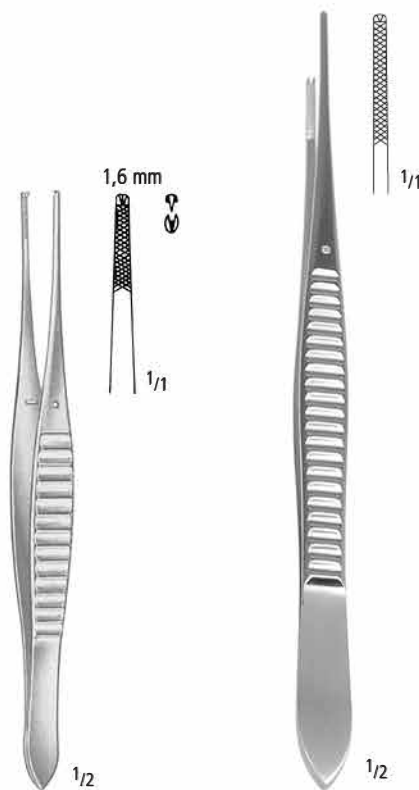

Fig. 1  
**AB 410/01**

Fig. 2  
**AB 410/02**

Fig. 3  
**AB 410/03**



**GILLIES 1:2**  
**AB 430/15**  
 15,0 cm/6"

**WAUGH 1:2**  
**AB 434/20**  
 20,5 cm/8"

**COLLIN-DUVAL**  
 20,0 cm/8"

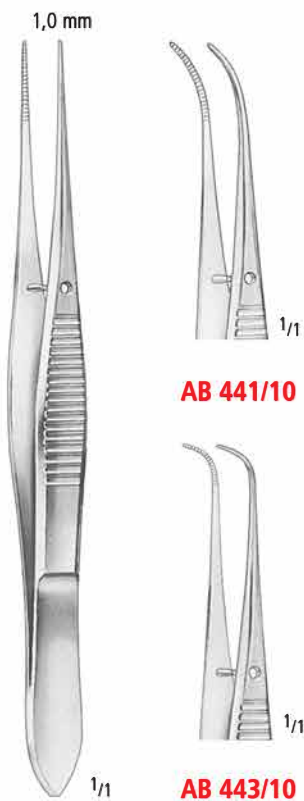

**AB 441/10**

**AB 443/10**

**AB 440/10**  
 10,5 cm/4 1/4"

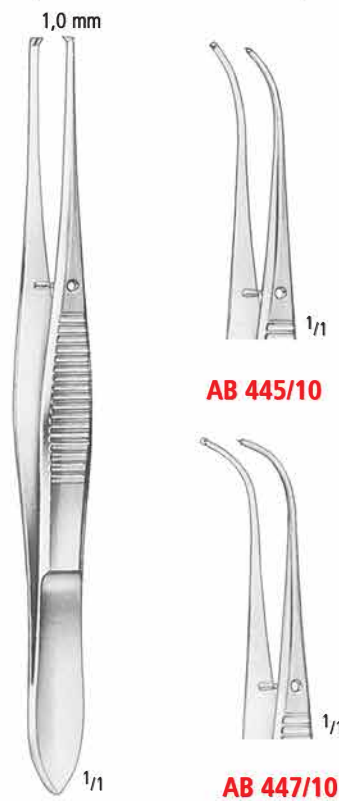

**1:2**  
**AB 444/10**  
 10,5 cm/4 1/4"

**AB 445/10**

**AB 447/10**

AA  
**AB**  
 AC  
 AD  
 AE  
 AF  
 AK  
 AL  
 AO  
 AP  
 AR  
 KA  
 KL  
 KM  
 KO  
 KU  
 KYE  
 X



**AB** PINZETTEN FORCEPS PINZAS PINCES PINZE

Chirurgische Pinzetten, Fasspinzetten  
 Tissue Forceps, Grasping Forceps  
 Pinzas de disección con dientes, Pinzas para coger  
 Pincès à griffes, Pincès pour saisir les tissus  
 Pinze chirurgiche a denti di topo, Pinze per afferare tessuti

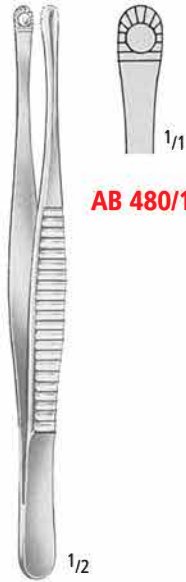

**AB 480/15**

**RUSS. MODELL**

15,0 cm/6" **AB 480/15**  
 20,0 cm/8" **AB 480/20**

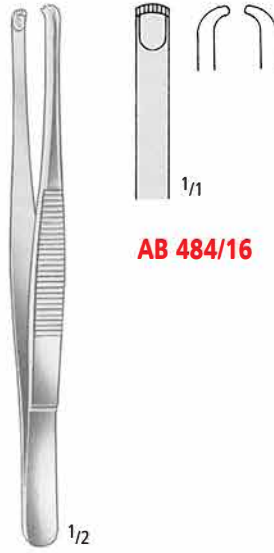

**AB 484/16**

**DURANTE**

14,5 cm/5<sup>3</sup>/<sub>4</sub>" **AB 484/14**  
 16,0 cm/6<sup>1</sup>/<sub>4</sub>" **AB 484/16**  
 20,0 cm/8" **AB 484/20**

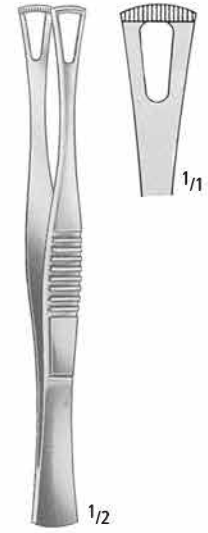

**DUVAL**

**AB 486/14**  
 14,5 cm/5<sup>3</sup>/<sub>4</sub>"

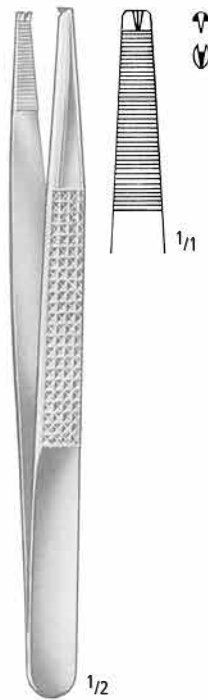



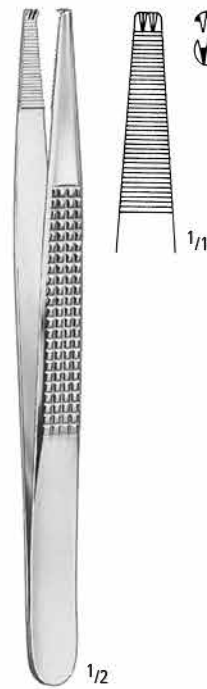





**BONNEY 1:2**  
**AB 490/18**  
 18,0 cm/7"



**BONNEY 2:3**  
**AB 492/18**  
 18,0 cm/7"

PINZETTEN FORCEPS PINZAS PINCES PINZE

Uhrmacherpinzetten  
 Jeweler's Forceps  
 Pinzas de relojero  
 Pincas d'horloger  
 Pinze da orologiaio

	1/1	No. 1	<b>AB 501/01</b> 12,0 cm/4 <sup>3</sup> / <sub>4</sub> "
	1/1	No. 2	<b>AB 501/02</b> 12,0 cm/4 <sup>3</sup> / <sub>4</sub> "
	1/1	No. 3	<b>AB 501/03</b> 12,0 cm/4 <sup>3</sup> / <sub>4</sub> "
	1/1	No. 4	<b>AB 501/04</b> 11,0 cm/4 <sup>1</sup> / <sub>3</sub> "
	1/1	No. 5	<b>AB 501/05</b> 11,0 cm/4 <sup>1</sup> / <sub>3</sub> "
	1/1	No. 5a	<b>AB 501/15</b> 11,0 cm/4 <sup>1</sup> / <sub>3</sub> "
	1/1	No. 5/45°	<b>AB 501/45</b> 10,5 cm/4 <sup>1</sup> / <sub>4</sub> "
	1/1	No. 5/90°	<b>AB 501/90</b> 10,5 cm/4 <sup>1</sup> / <sub>4</sub> "
	1/1	No. 7	<b>AB 502/07</b> 11,5 cm/4 <sup>1</sup> / <sub>2</sub> "

AA

AB

AC

AD

AE

AF

AK

AL

AO

AP

AR

KA

KL

KM

KO

KU

KYE

X

**AB** PINZETTEN FORCEPS PINZAS PINCES PINZE

Mikro-Pinzetten, Knüpfpinzetten mit Plateau  
 Micro Forceps, Suture Tying Forceps with platform  
 Micro-Pinzas, Pinzas de ligadura con plataforma  
 Micro-Pinces, Pinces à ligature avec plate-forme  
 Micro-Pinze, Pinze per ligature con piattaforma

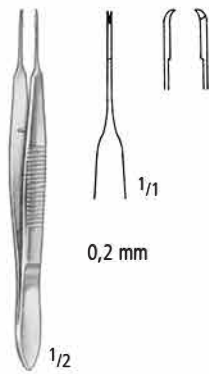

**1:2**  
**AB 530/09**  
 9,5 cm/3<sup>3</sup>/<sub>4</sub>"

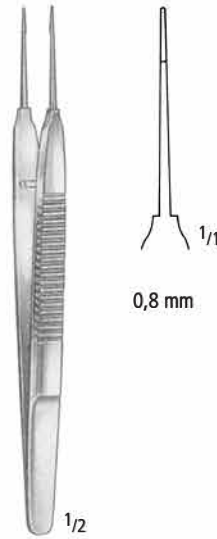

**AUSTIN**  
**AB 532/14**  
 14,0 cm/5<sup>1</sup>/<sub>2</sub>"

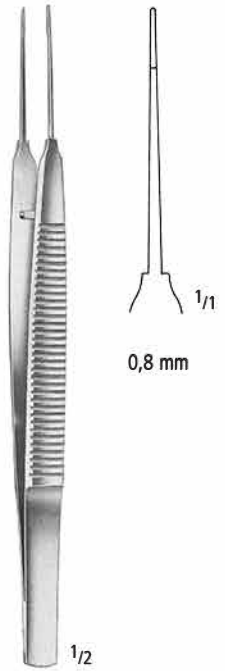

**AUSTIN**  
**AB 532/18**  
 18,0 cm/7"

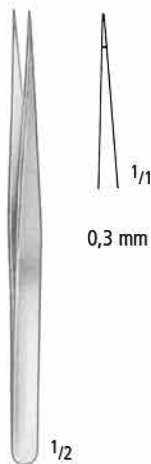

**AB 534/12**  
 12,0 cm/4<sup>3</sup>/<sub>4</sub>"



**VISE**  
**AB 534/13**  
 13,5 cm/5<sup>1</sup>/<sub>4</sub>"

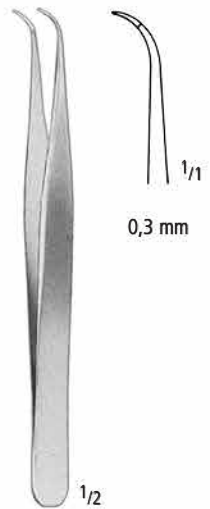

**VISE**  
**AB 535/13**  
 13,5 cm/5<sup>1</sup>/<sub>4</sub>"

PINZETTEN FORCEPS PINZAS PINCES PINZE

Mikro-Pinzetten, Knüpfpinzetten mit Plateau, Gefäßdilator  
 Micro Forceps, Suture Tying Forceps with platform, Vessel Dilator  
 Micro-Pinzas, Pinzas de ligadura con plataforma, Dilatador para vasos  
 Micro-Pinces, Pinces à ligature avec plate-forme, Dilatateur pour vaisseaux  
 Micro-Pinze, Pinze per ligature con piattaforma, Dilatatore per vasi



**AB 536/14**  
 14,0 cm/5 1/2"



**1:2**  
**AB 538/14**  
 14,0 cm/5 1/2"

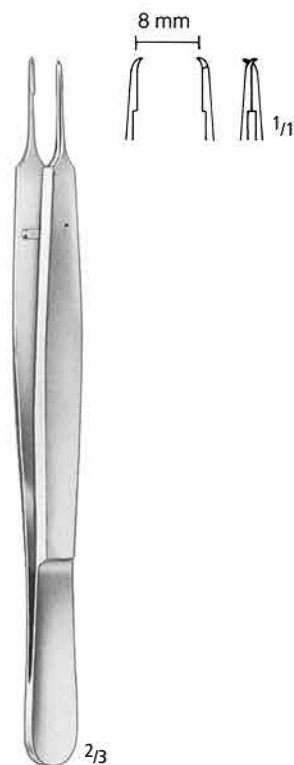

**1:2**  
**AB 540/14**  
 14,0 cm/5 1/2"

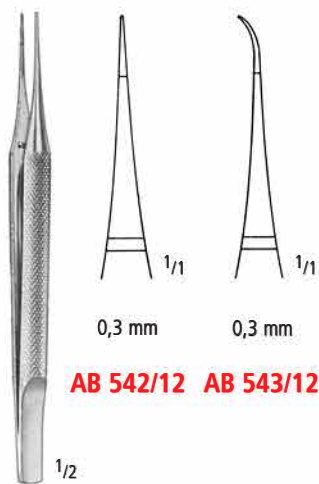

12,0 cm/4 3/4"  
 15,0 cm/6"

**AB 542/12 AB 543/12**  
**AB 542/15 AB 543/15**

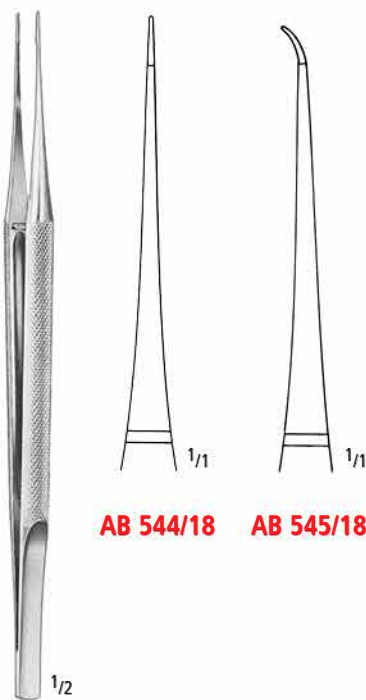

18,0 cm/7"

**AB 544/18 AB 545/18**

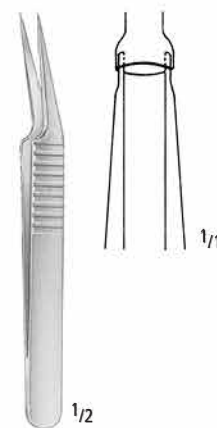

**AB 546/11**  
 11,0 cm/4 1/3"

AA  
 AB  
 AC  
 AD  
 AE  
 AF  
 AK  
 AL  
 AO  
 AP  
 AR  
 KA  
 KL  
 KM  
 KO  
 KU  
 KYE  
 X

Splitter-Pinzetten  
 Splinter Forceps  
 Pinzas para espinas  
 Pincas à échardes  
 Pinze per schegge



**AB 550/11**

1/1

**FEILCHENFELD**

- 7,5 cm/3" **AB 550/07**
- 9,0 cm/3 1/2" **AB 550/09**
- 11,5 cm/4 1/2" **AB 550/11**



**HUNTER**

- AB 552/10**
- 10,5 cm/4 1/4"

1/1



**HUNTER**

- AB 553/10**
- 10,5 cm/4 1/4"

1/1



PINZETTEN FORCEPS PINZAS PINCES PINZE

Splitter-Pinzetten  
 Splinter Forceps  
 Pinzas para espinas  
 Pincas à écharde  
 Pinze per schegge

ohne Führungsstift  
 without guide pin  
 sin espiga de guía  
 sans repères  
 senza perno da guida

8,0 cm/3"  
 9,0 cm/3½"  
 10,5 cm/4¼"  
 11,5 cm/4⅓"  
 12,5 cm/5"  
 14,5 cm/5¾"



**AB 562/10**

**AB 562/08**  
**AB 562/09**  
**AB 562/10**  
**AB 562/11**  
**AB 562/12**  
**AB 562/14**

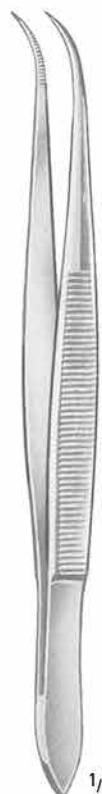

**AB 563/10**

**AB 563/08**  
**AB 563/09**  
**AB 563/10**  
**AB 563/11**  
**AB 563/12**  
**AB 563/14**

mit Führungsstift  
 with guide pin  
 con espiga de guía  
 avec repères  
 con perno da guida

10,5 cm/4¼"  
 11,5 cm/4½"  
 12,5 cm/5"  
 14,5 cm/5¾"

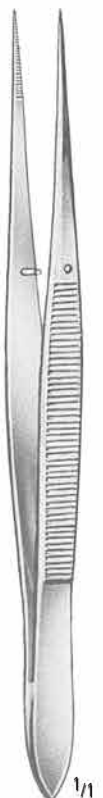

**AB 566/10**

**AB 566/10**  
**AB 566/11**  
**AB 566/12**  
**AB 566/14**



**AB 567/10**

**AB 567/10**  
**AB 567/11**  
**AB 567/12**  
**AB 567/14**

AA

**AB**

AC

AD

AE

AF

AG

AH

AI

AJ

AK

AL

AM

AN

AO

AP

AQ

AR

AS

**AB** PINZETTEN FORCEPS PINZAS PINCES PINZE

Splitter-Pinzetten  
 Splinter Forceps  
 Pinzas para espinas  
 Pincers à échardes  
 Pinze per schegge

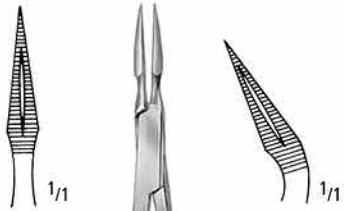

**AB 570/13**

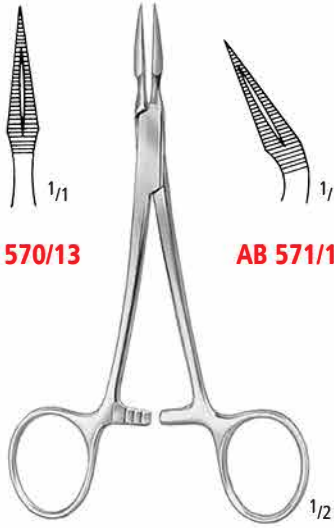

**STIEGLITZ**  
 13,5 cm/5<sup>1</sup>/<sub>4</sub>"

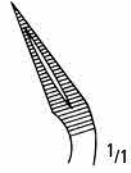

**AB 571/13**



**STIEGLITZ**  
**AB 571/90**  
 13,5 cm/5<sup>1</sup>/<sub>4</sub>"

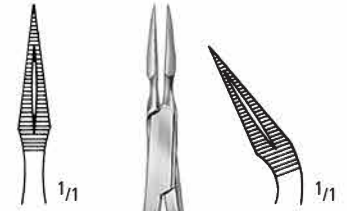

**AB 572/13**

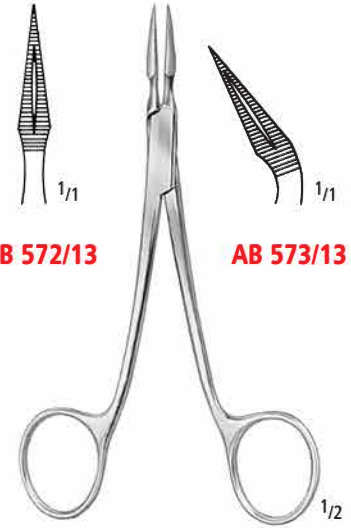

**STIEGLITZ**  
 13,5 cm/5<sup>1</sup>/<sub>4</sub>"

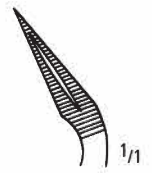

**AB 573/13**

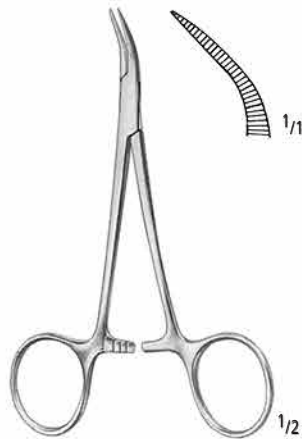

**PEET**  
**AB 580/11**  
 11,5 cm/4<sup>1</sup>/<sub>2</sub>"

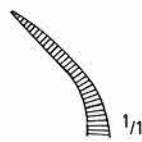

**AB 582/15**

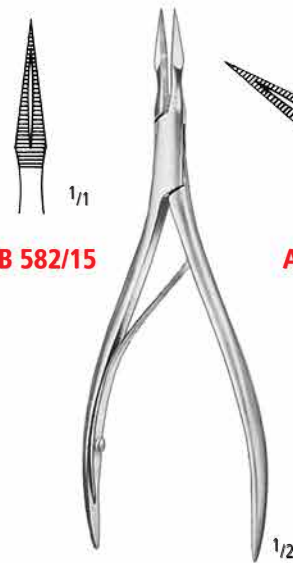

**RALK**  
 15,0 cm/6"



**AB 583/15**

PINZETTEN FORCEPS PINZAS PINCES PINZE

Cilienpinzetten  
Cilia Forceps  
Pinzas depilatorias  
Pincas à épiler les cils  
Pinze depilatorie



**LITTAUER**  
**AB 620/08**  
8,5 cm/3<sup>1</sup>/<sub>3</sub>"



**AB 621/09**  
9,0 cm/3<sup>1</sup>/<sub>2</sub>"



**DOUGLAS**  
**AB 624/09**  
9,0 cm/3<sup>1</sup>/<sub>2</sub>"

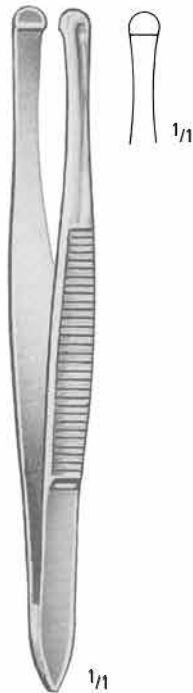

**BEER**  
**AB 626/09**  
9,0 cm/3<sup>1</sup>/<sub>2</sub>"

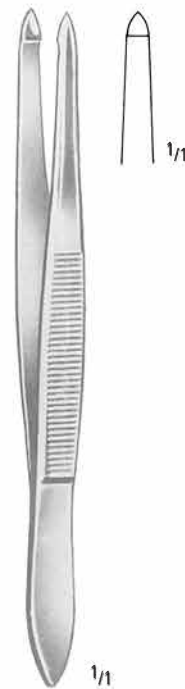

**ZIEGLER**  
**AB 628/09**  
9,0 cm/3<sup>1</sup>/<sub>2</sub>"

AA  
AB  
AC  
AD  
AE  
AF  
AK  
AL  
AO  
AP  
AR  
KA  
KL  
KM  
KO  
KU  
KYE  
X

**AB** PINZETTEN FORCEPS PINZAS PINCES PINZE

Ohr- und Nasenpinzetten  
 Ear and Nose Dressing Forceps  
 Pinzas auriculares y nasales  
 Pincas auriculaires et nasales  
 Pinze auricolare e nasale



**AB 650/11**

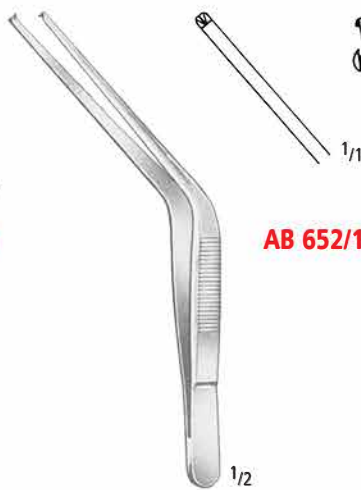

**AB 652/12**

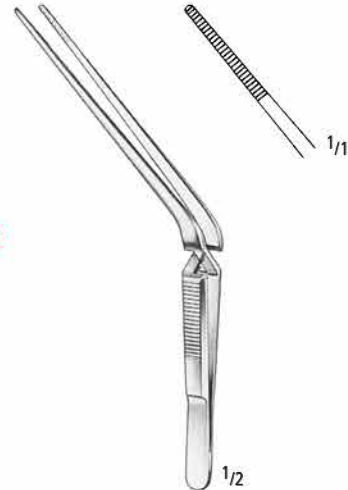

**TROELTSCH (WILDE)**

Mod. Jalasvirta

**AB 654/11**

**AB 654/13**

11,0 cm/4<sup>1</sup>/<sub>3</sub>"

13,0 cm/5"

11,0 cm/4<sup>1</sup>/<sub>3</sub>"

12,0 cm/4<sup>3</sup>/<sub>4</sub>"

15,0 cm/6"

18,0 cm/7"

**TROELTSCH (WILDE)**

**AB 650/11**

**AB 650/12**

**AB 650/15**

**AB 650/18**

**TROELTSCH (WILDE) 1:2**

**AB 652/12**

**AB 652/15**

**AB 652/18**



**LUCAE**

**AB 656/14**

14,0 cm/5<sup>1</sup>/<sub>2</sub>"

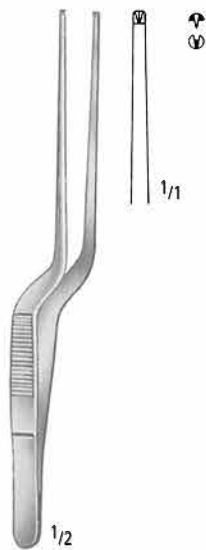

**LUCAE 1:2**

**AB 658/14**

14,0 cm/5<sup>1</sup>/<sub>2</sub>"



**AB 660/18**

**JANSEN**

16,0 cm/6<sup>1</sup>/<sub>4</sub>"

18,0 cm/7"

20,0 cm/8"

**AB 660/16**

**AB 660/18**

**AB 660/20**

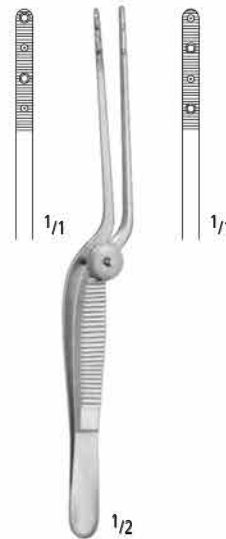

**COTTLE**

**AB 665/14**

14,0 cm/5<sup>1</sup>/<sub>2</sub>"



**GRUENWALD (JANSEN)**

**AB 690/20**

20,0 cm/8"

PINZETTEN FORCEPS PINZAS PINCES PINZE

Fixierpinzetten, Nahtpinzetten  
 Fixation Forceps, Suture Forceps  
 Pinzas de fijación, Pinzas para sutura  
 Pincas à fixer, Pincas pour sutures  
 Pinze fissatrice, Pinze per sutura



**ST. MARTIN 1:2**  
**AB 812/07**  
 7,0 cm/2<sup>3</sup>/<sub>4</sub>"



0,12 mm  
 0,30 mm  
 0,50 mm  
 1,00 mm  
 1,50 mm

**CASTROVIEJO 1:2**  
 10,0 cm/4"



**AB 816/01**

**AB 816/01**  
**AB 816/03**  
**AB 816/05**  
**AB 816/10**  
**AB 816/15**



**AB 817/01**

**AB 817/01**  
**AB 817/03**  
**AB 817/05**  
**AB 817/10**  
**AB 817/15**



**AB 819/01**



**McPHERSON**  
 10,0 cm/4"



**AB 819/02**



**KELMAN-McPHERSON 1:2**  
**AB 820/10**  
 10,0 cm/4"

AA  
 AB  
 AC  
 AD  
 AE  
 AF  
 AG  
 AH  
 AI  
 AJ  
 AK  
 AL  
 AM  
 AN  
 AO  
 AP  
 AQ  
 AR  
 AS  
 AT  
 AU  
 AV  
 AW  
 AX



**AB** PINZETTEN FORCEPS PINZAS PINCES PINZE

Nahtpinzetten  
Suture Forceps  
Pinzas para sutura  
Pinces pour sutures  
Pinze per sutura



**BONACCOLTO**  
**AB 824/01**  
10,0 cm/4"



**BONACCOLTO**  
**AB 824/02**  
10,0 cm/4"



10 x  
0,12 mm

**AB 825/01**



**AB 825/02**



**MOD. BONN**  
10,0 cm/4"

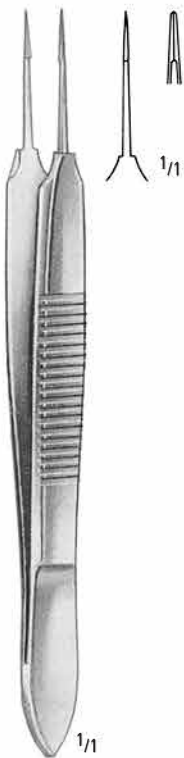

**MOD. TÜBINGEN**  
**AB 826/10**  
10,0 cm/4"



**PAUFIQUE 1:2**  
**AB 828/10**  
10,0 cm/4"



**HARMS**  
**AB 829/01**  
10,0 cm/4"

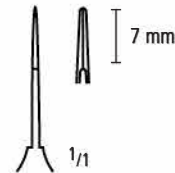

**HARMS**  
**AB 829/02**  
10,0 cm/4"

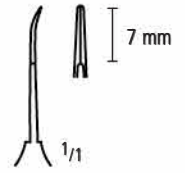

PINZETTEN FORCEPS PINZAS PINCES PINZE

Atraumatische Pinzetten  
 Non-traumatic Vascular Tissue Forceps  
 Pinzas Atrauma  
 Pincas Atrauma  
 Pinze Atrauma



**AB 860/16** = 16,0 cm/6 1/4"  
**AB 860/20** = 20,0 cm/8"

DE BAKAY

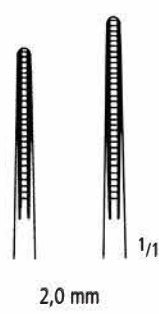

**AB 862/16** = 16,0 cm/6 1/4"  
**AB 862/20** = 20,0 cm/8"

DE BAKAY

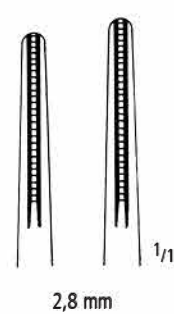

**AB 864/16** = 16,0 cm/6 1/4"  
**AB 864/20** = 20,0 cm/8"

DE BAKAY

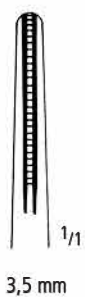

**AB 866/20** = 20,0 cm/8"

DE BAKAY



**AB 869/16** = 16,0 cm/6 1/4"  
**AB 869/20** = 20,0 cm/8"



DE BAKAY

AA  
**AB**  
 AC  
 AD  
 AE  
 AF  
 AK  
 AL  
 AO  
 AP  
 AR  
 KA  
 KL  
 KM  
 KO  
 KU  
 KYE  
 X

**AB** PINZETTEN FORCEPS PINZAS PINCES PINZE





Pinzetten mit Hartmetalleinsätzen  
 Dissecting Forceps with Tungsten Carbide Inserts  
 Pinzas de disección con bocas de carburo de tungsteno  
 Pincés à dissection avec mors en carbure de tungstène  
 Pinze per dissezione con punte di carburo di tungsteno



-   $1/1$   
**AB 880/15**  
15,0 cm/6"
-   $1/1$   
**AB 880/18**  
18,0 cm/7"
-   $1/1$   
**AB 880/20**  
20,0 cm/8"

**POTTS-SMITH**



-   $1/1$   
**AB 882/14**  
14,0 cm/5 $\frac{1}{2}$ "
-   $1/1$   
**AB 882/16**  
16,0 cm/6 $\frac{1}{4}$ "
-   $1/1$   
**AB 882/18**  
18,0 cm/7"
-   $1/1$   
**AB 882/20**  
20,0 cm/8"

**OEHLER 1:2**



-   $1/1$   
**AB 890/12**

- SEMKEN**
- AB 890/12** 12,5 cm/5"
- AB 890/15** 15,5 cm/6"



-   $1/1$

- GILLIES 1:2**
- AB 900/15** 15,0 cm/6"



-   $1/1$

- JEWELER**
- AB 902/15** 15,0 cm/6"

PINZETTEN FORCEPS PINZAS PINCES PINZE

Pinzetten mit Hartmetalleinsätzen  
 Dissecting Forceps with Tungsten Carbide Inserts  
 Pinzas de disección con bocas de carburo de tungsteno  
 Pincès à dissection avec mors en carbure de tungstène  
 Pinze per dissezione con punte di carburo di tungsteno



**ADSON**

**AB 930/12**  
12,0 cm/4<sup>3</sup>/<sub>4</sub>"



**AB 932/12**  
12,0 cm/4<sup>3</sup>/<sub>4</sub>"



**AB 930/15**  
15,0 cm/6"



**AB 932/15**  
15,0 cm/6"



**CUSHING**  
17,5 cm/7"

**AB 940/17**



**AB 941/18**

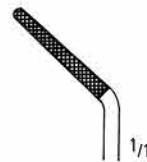

mit Dissektor-Ende  
 with dissector end  
 con cabo disecador  
 avec bout dissecteur  
 con dissettore



**CUSHING-TAYLOR**  
**AB 943/18**  
18,0 cm/7"



AA  
 AB  
 AC  
 AD  
 AE  
 AF  
 AG  
 AH  
 AI  
 AJ  
 AK  
 AL  
 AO  
 AP  
 AR  
 AS  
 AT  
 AU  
 AV  
 AW  
 AX

Pinzetten mit Hartmetalleinsätzen  
 Dissecting Forceps with Tungsten Carbide Inserts  
 Pinzas de disección con bocas de carburo de tungsteno  
 Pincas à dissection avec mors en carbure de tungstène  
 Pinze per dissezione con punte di carburo di tungsteno

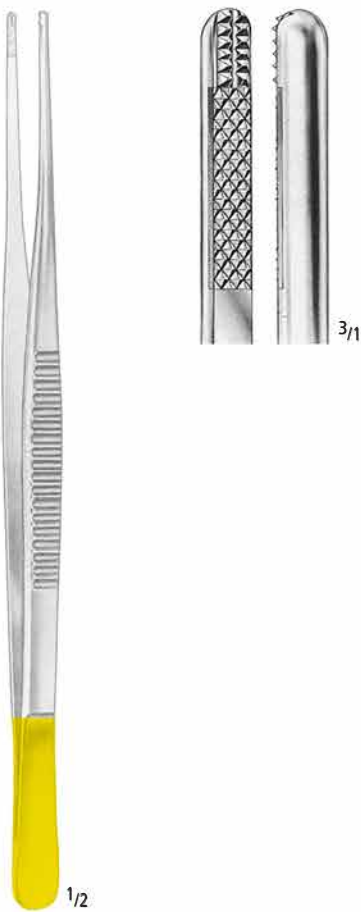

**DE BAKEY**  
 16,0 cm/6<sup>1</sup>/<sub>4</sub>"  
 20,0 cm/8"

1,5 mm	2,0 mm
<b>AB 944/16</b>	<b>AB 946/16</b>
<b>AB 944/20</b>	<b>AB 946/20</b>



**BONNEY 1:2**  
 AB 948/18  
 18,0 cm/7"



**WANGENSTEEN**  
 AB 950/15  
 15,0 cm/6"



SCHEREN  
SCISSORS  
TIJERAS  
CISEAUX  
FORBICI

AC

nopa<sup>®</sup> instruments

Weitere Scheren finden Sie in unserem Katalog „Allgemeines Instrumentarium“ in Gruppe AC.

For further scissors kindly refer to our catalogue „General Instruments“, section AC.

Para tijeras adicionales, por favor consulte nuestro catálogo de „Instrumental de uso general“, grupo AC.

Pour des ciseaux supplémentaires, consultez notre catalogue „Instrumentation Generale“, section AC.

Per gli altri forbici, consultare il nostro catalogo „Strumentazione Generale“, gruppo AC.





**nopa<sup>®</sup> SC**  
**SUPER CUT**



**Besonderheit:**

**nopa Super Cut** Scheren haben eine rasierklingscharfe Schneide, kombiniert mit einer mikrogezahnten Schneide.

>> Diese Scheren sind durch einen glänzenden und einen sandgestrahlten Ring gekennzeichnet.

**Features:**

**nopa Super Cut** scissors have a razor-like edge combined with one micro serrated blade.

>> these scissors are characterized by a shiny and a matt finish ring.

**Verfügbare Modelle / Available Patterns**

Im Katalog durch \* markiert. / Marked in the catalog with \* .

AC 010/14 SC	Standard Operating Scissors, straight, blunt/blunt, 14.5 cm SC
AC 011/14 SC	Standard Operating Scissors, curved, blunt/blunt, 14.5 cm SC
AC 020/14 SC	Standard Operating Scissors, straight, sharp/blunt, 14.5 cm SC
AC 021/14 SC	Standard Operating Scissors, curved, sharp/blunt, 14.5 cm SC
AC 030/14 SC	Standard Operating Scissors, straight, sharp/sharp, 14.5 cm SC
AC 031/14 SC	Standard Operating Scissors, curved, sharp/sharp, 14.5 cm SC
AC 070/14 SC	MAYO Operating Scissors, straight, blunt/blunt, 14.5 cm SC
AC 070/17 SC	MAYO Operating Scissors, straight, blunt/blunt, 17.0 cm SC
AC 071/14 SC	MAYO Operating Scissors, curved, blunt/blunt, 14.5 cm SC
AC 071/17 SC	MAYO Operating Scissors, curved, blunt/blunt, 17.0 cm SC
AC 072/17 SC	MAYO-STILLE Operating Scissors, straight, blunt/blunt, 17.0 cm SC
AC 073/17 SC	MAYO-STILLE Operating Scissors, curved, blunt/blunt, 17.0 cm SC
AC 100/14 SC	METZENBAUM Scissors, straight, blunt/blunt, 14.0 cm SC
AC 101/14 SC	METZENBAUM Scissors, curved, blunt/blunt, 14.0 cm SC
AC 110/18 SC	METZENBAUM-NELSON Scissors, blunt/blunt, 18.0 cm SC
AC 110/20 SC	METZENBAUM-NELSON Scissors, straight, blunt/blunt 20.0 cm SC
AC 111/18 SC	METZENBAUM-NELSON Scissors, curved, 18.0 cm SC
AC 111/20 SC	METZENBAUM-NELSON Scissors, curved, 20.0 cm SC
AC 140/14 SC	METZENBAUM-DELICATE Scissors, straight, blunt/blunt, 14.5 cm SC
AC 141/14 SC	METZENBAUM-DELICATE Scissors, curved, blunt/blunt, 14.5 cm SC
AC 150/18 SC	METZENBAUM-DELICATE Scissors, straight, blunt/blunt, 18.0 cm SC
AC 151/18 SC	METZENBAUM-DELICATE Scissors, curved, blunt/blunt, 18.0 cm SC
AC 166/20 SC	GORNEY Dissecting Scissors, straight, toothed, 19.5 cm SC
AC 167/20 SC	GORNEY Dissecting Scissors, curved, toothed, 19.5 cm SC
AC 170/16 SC	LEXER Dissecting Scissors, straight, 16.0 cm SC
AC 171/16 SC	LEXER Dissecting Scissors, curved, 16.0 cm SC
AC 204/14 SC	JOSEPH plastic surgery scissors, straight, 14.0 cm SC
AC 205/14 SC	JOSEPH plastic surgery scissors, curved, 14.0 cm SC
AC 208/12 SC	KILNER plastic surgery scissors, straight, 12.0 cm SC
AC 210/12 SC	KILNER plastic surgery scissors, curved, 12.0 cm SC
AC 214/15 SC	REYNOLDS Dissecting Scissors, straight, sharp, 15.0 cm SC
AC 214/18 SC	REYNOLDS Dissecting Scissors, straight, sharp, 18.0 cm SC
AC 215/15 SC	REYNOLDS Dissecting Scissors, curved, sharp, 15.0 cm SC
AC 215/18 SC	REYNOLDS Dissecting Scissors, curved, sharp, 18.0 cm SC
AC 408/11 SC	Fine Operating Scissors, straight, sharp/sharp, 11.0 cm SC
AC 409/11 SC	Fine Operating Scissors, curved, sharp/sharp, 11.0 cm SC
AC 450/11 SC	Iris Scissors, straight, sharp/sharp, 11.5 cm SC
AC 451/11 SC	Iris Scissors, curved, sharp/sharp, 11.5 cm SC
AC 476/11 SC	STEVENS Tenotomy Scissors, straight, blunt, 11.5 cm SC
AC 477/11 SC	STEVENS Tenotomy Scissors, curved, blunt, 11.5 cm SC

AA  
AB  
AC  
AD  
AE  
AF  
AK  
AL  
AO  
AP  
AR  
KA  
KL  
KM  
KO  
KU  
KYE  
X

**AC** SCHEREN SCISSORS TIJERAS CISEAUX FORBICI

Chirurgische Scheren  
Operating Scissors  
Tijeras para cirugía  
Ciseaux à chirurgie  
Forbici per chirurgia



Original 13,0 cm

**STANDARD**

Fig.1  
gerade  
straight  
rectas  
droits  
rette

- AC 010/10 10,5 cm/4<sup>1</sup>/<sub>4</sub>"
- AC 010/11 11,5 cm/4<sup>1</sup>/<sub>2</sub>"
- AC 010/13 13,0 cm/5"
- AC 010/14\* 14,5 cm/5<sup>3</sup>/<sub>4</sub>"
- AC 010/15 15,5 cm/6"
- AC 010/16 16,5 cm/6<sup>1</sup>/<sub>2</sub>"
- AC 010/17 17,5 cm/7"
- AC 010/18 18,5 cm/7<sup>1</sup>/<sub>3</sub>"
- AC 010/20 20,0 cm/8"

**STANDARD**

Fig.1  
gebogen  
curved  
curvas  
courbes  
curve

- AC 011/10 10,5 cm/4<sup>1</sup>/<sub>4</sub>"
- AC 011/11 11,5 cm/4<sup>1</sup>/<sub>2</sub>"
- AC 011/13 13,0 cm/5"
- AC 011/14\* 14,5 cm/5<sup>3</sup>/<sub>4</sub>"
- AC 011/15 15,5 cm/6"
- AC 011/16 16,5 cm/6<sup>1</sup>/<sub>2</sub>"
- AC 011/17 17,5 cm/7"
- AC 011/18 18,5 cm/7<sup>1</sup>/<sub>3</sub>"
- AC 011/20 20,0 cm/8"



Original 13,0 cm

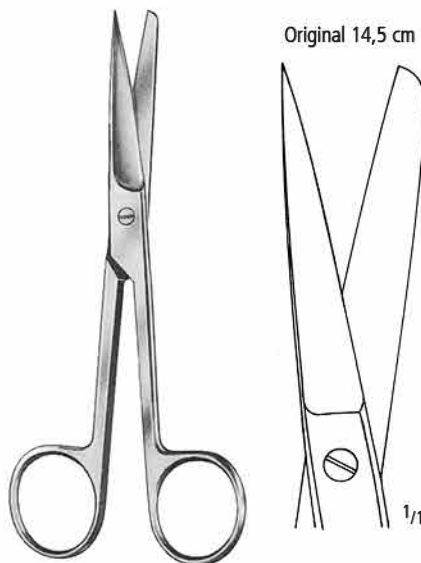

Original 14,5 cm

**STANDARD**

Fig.2  
gerade  
straight  
rectas  
droits  
rette

- AC 020/10 10,5 cm/4<sup>1</sup>/<sub>4</sub>"
- AC 020/11 11,5 cm/4<sup>1</sup>/<sub>2</sub>"
- AC 020/13 13,0 cm/5"
- AC 020/14\* 14,5 cm/5<sup>3</sup>/<sub>4</sub>"
- AC 020/15 15,5 cm/6"
- AC 020/16 16,5 cm/6<sup>1</sup>/<sub>2</sub>"
- AC 020/17 17,5 cm/7"
- AC 020/18 18,5 cm/7<sup>1</sup>/<sub>3</sub>"
- AC 020/20 20,0 cm/8"

**STANDARD**

Fig.2  
gebogen  
curved  
curvas  
courbes  
curve

- AC 021/10 10,5 cm/4<sup>1</sup>/<sub>4</sub>"
- AC 021/11 11,5 cm/4<sup>1</sup>/<sub>2</sub>"
- AC 021/13 13,0 cm/5"
- AC 021/14\* 14,5 cm/5<sup>3</sup>/<sub>4</sub>"
- AC 021/15 15,5 cm/6"
- AC 021/16 16,5 cm/6<sup>1</sup>/<sub>2</sub>"
- AC 021/17 17,5 cm/7"
- AC 021/18 18,5 cm/7<sup>1</sup>/<sub>3</sub>"
- AC 021/20 20,0 cm/8"



Original 14,5 cm

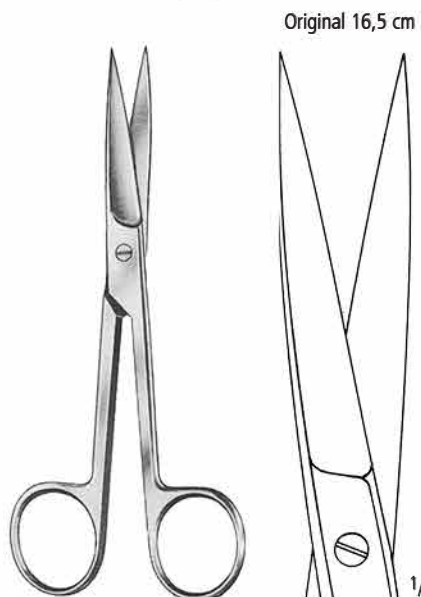

Original 16,5 cm

**STANDARD**

Fig.3  
gerade  
straight  
rectas  
droits  
rette

- AC 030/10 10,5 cm/4<sup>1</sup>/<sub>4</sub>"
- AC 030/11 11,5 cm/4<sup>1</sup>/<sub>2</sub>"
- AC 030/13 13,0 cm/5"
- AC 030/14\* 14,5 cm/5<sup>3</sup>/<sub>4</sub>"
- AC 030/15 15,5 cm/6"
- AC 030/16 16,5 cm/6<sup>1</sup>/<sub>2</sub>"
- AC 030/17 17,5 cm/7"
- AC 030/18 18,5 cm/7<sup>1</sup>/<sub>3</sub>"
- AC 030/20 20,0 cm/8"

**STANDARD**

Fig.3  
gebogen  
curved  
curvas  
courbes  
curve

- AC 031/10 10,5 cm/4<sup>1</sup>/<sub>4</sub>"
- AC 031/11 11,5 cm/4<sup>1</sup>/<sub>2</sub>"
- AC 031/13 13,0 cm/5"
- AC 031/14\* 14,5 cm/5<sup>3</sup>/<sub>4</sub>"
- AC 031/15 15,5 cm/6"
- AC 031/16 16,5 cm/6<sup>1</sup>/<sub>2</sub>"
- AC 031/17 17,5 cm/7"
- AC 031/18 18,5 cm/7<sup>1</sup>/<sub>3</sub>"
- AC 031/20 20,0 cm/8"

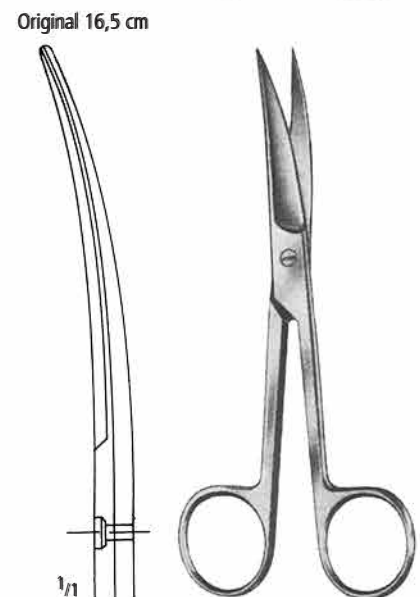

Original 16,5 cm

SCHEREN SCISSORS TIJERAS CISEAUX FORBICI

Chirurgische Scheren  
Operating Scissors  
Tijeras para cirugía  
Ciseaux à chirurgie  
Forbici per chirurgia



Original 13,0 cm

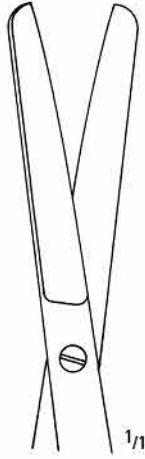

**GRAZIL**

Fig.1  
gerade  
straight  
rectas  
droits  
rette

**AC 040/13**  
**AC 040/14**

13,0 cm/5"  
14,5 cm/5<sup>3</sup>/<sub>16</sub>"

Original 13,0 cm



**GRAZIL**

Fig. 1  
gebogen  
curved  
curvas  
courbes  
curve

**AC 041/13**  
**AC 041/14**



Original 14,5 cm

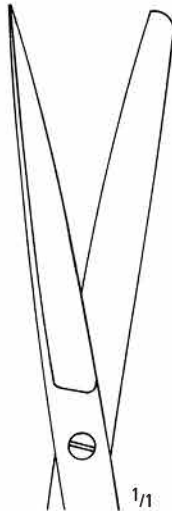

**GRAZIL**

Fig.2  
gerade  
straight  
rectas  
droits  
rette

**AC 042/13**  
**AC 042/14**

13,0 cm/5"  
14,5 cm/5<sup>3</sup>/<sub>16</sub>"

Original 14,5 cm



**GRAZIL**

Fig. 2  
gebogen  
curved  
curvas  
courbes  
curve

**AC 043/13**  
**AC 043/14**



Original 14,5 cm

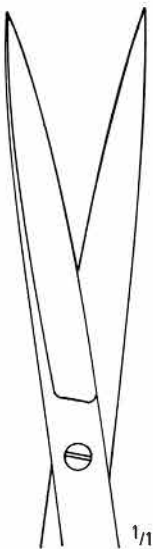

**GRAZIL**

Fig.3  
gerade  
straight  
rectas  
droits  
rette

**AC 046/13**  
**AC 046/14**

13,0 cm/5"  
14,5 cm/5<sup>3</sup>/<sub>16</sub>"

Original 14,5 cm



**GRAZIL**

Fig. 3  
gebogen  
curved  
curvas  
courbes  
curve

**AC 047/13**  
**AC 047/14**



AA  
AB  
**AC**  
AD  
AE  
AF  
AK  
AL  
AO  
AP  
AR  
KA  
KL  
KM  
KO  
KU  
KYE  
X



**AC** SCHEREN SCISSORS TIJERAS CISEAUX FORBICI

Chirurgische Scheren  
 Operating Scissors  
 Tijeras para cirugía  
 Ciseaux à chirurgie  
 Forbici per chirurgia

Inzisionsscheren  
 Incision Scissors  
 Tijeras para incision  
 Ciseaux à incision  
 Forbici per incisioni

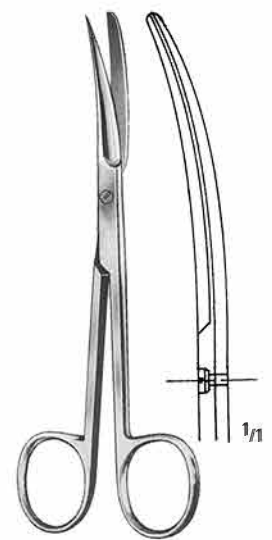

**AC 052/13** = 13,0 cm/5"  
**AC 052/14** = 14,5 cm/5<sup>3</sup>/<sub>4</sub>"

**AC 054/15**  
 15,5 cm/6"

**RICHTER**  
**AC 056/14**  
 14,5 cm/5<sup>3</sup>/<sub>4</sub>"

**AC 060/14**      **DEAVER**  
 14,0 cm/5<sup>1</sup>/<sub>2</sub>"

**AC 061/14**

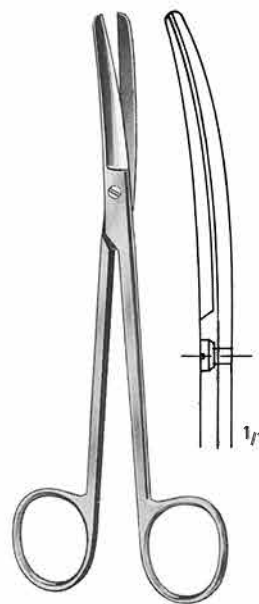

**AC 062/15**      **MIXTER**  
 15,5 cm/6"

**AC 063/15**

SCHEREN SCISSORS TIJERAS CISEAUX FORBICI

Chirurgische Scheren, Präparierscheren  
 Operating Scissors, Dissecting Scissors  
 Tijeras para cirugía, Tijeras para preparaciones  
 Ciseaux à chirurgie, Ciseaux à dissection  
 Forbici per chirurgia, Forbici per preparazioni

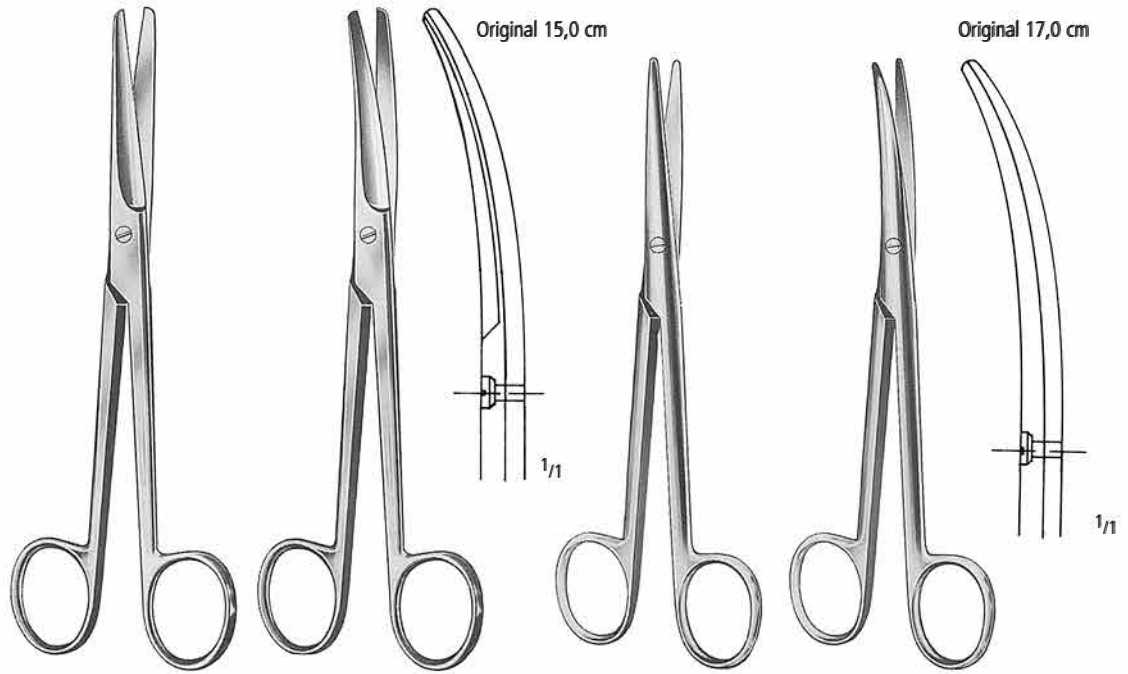

MAYO

MAYO-STILLE

14,5 cm/5 <sup>3</sup> / <sub>4</sub> "	<b>AC 070/14*</b>	<b>AC 071/14*</b>		
15,0 cm/6"			<b>AC 072/15</b>	<b>AC 073/15</b>
17,0 cm/6 <sup>3</sup> / <sub>4</sub> "	<b>AC 070/17*</b>	<b>AC 071/17*</b>	<b>AC 072/17*</b>	<b>AC 073/17*</b>
19,5 cm/7 <sup>3</sup> / <sub>4</sub> "			<b>AC 072/19</b>	<b>AC 073/19</b>

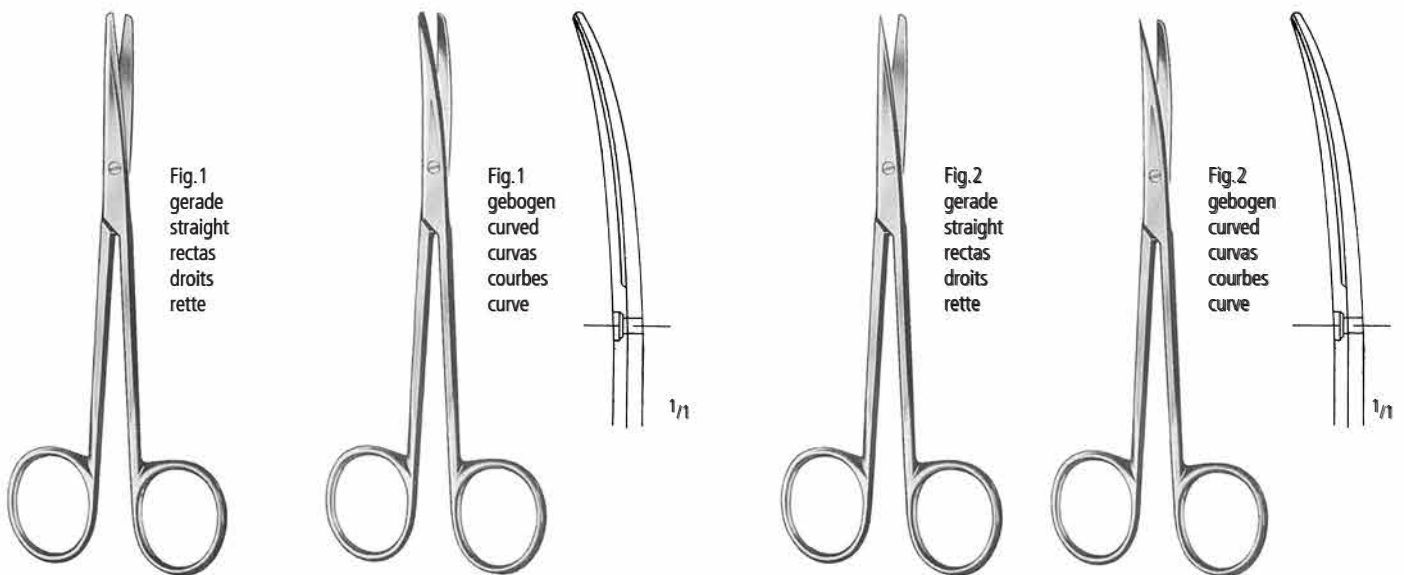

METZENBAUM

METZENBAUM

**AC 100/14\***  
14,5 cm/5<sup>3</sup>/<sub>4</sub>"

**AC 101/14\***  
14,5 cm/5<sup>3</sup>/<sub>4</sub>"

**AC 102/14**  
14,5 cm/5<sup>3</sup>/<sub>4</sub>"

**AC 103/14**  
14,5 cm/5<sup>3</sup>/<sub>4</sub>"

Präparierscheren  
 Dissecting Scissors  
 Tijeras para preparaciones  
 Ciseaux à dissection  
 Forbici per preparazioni



Fig.3  
 gerade  
 straight  
 rectas  
 droits  
 rette

**AC 104/14**  
 14,5 cm/5<sup>3</sup>/<sub>4</sub>"

**METZENBAUM**

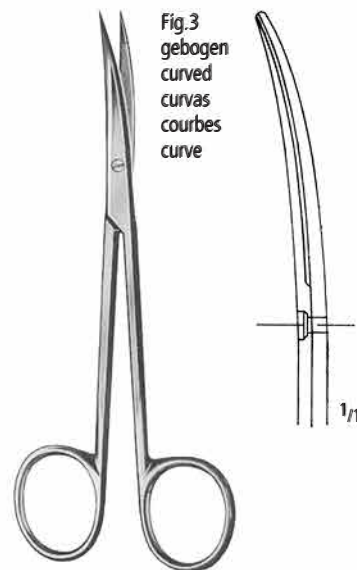

Fig.3  
 gebogen  
 curved  
 curvas  
 courbes  
 curve

**AC 105/14**  
 14,5 cm/5<sup>3</sup>/<sub>4</sub>"



gerade  
 straight  
 rectas  
 droits  
 rette

**AC 108/11**  
 11,5 cm/4<sup>1</sup>/<sub>2</sub>"

**METZENBAUM-BABY**

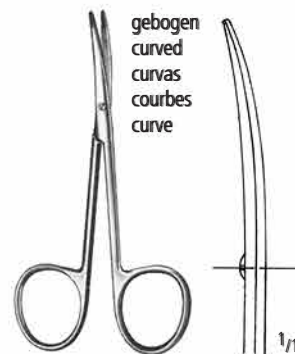

gebogen  
 curved  
 curvas  
 courbes  
 curve

**AC 109/11**  
 11,5 cm/4<sup>1</sup>/<sub>2</sub>"

SCHEREN SCISSORS TIJERAS CISEAUX FORBICI

Präparierscheren  
Dissecting Scissors  
Tijeras para preparaciones  
Ciseaux à dissection  
Forbici per preparazioni

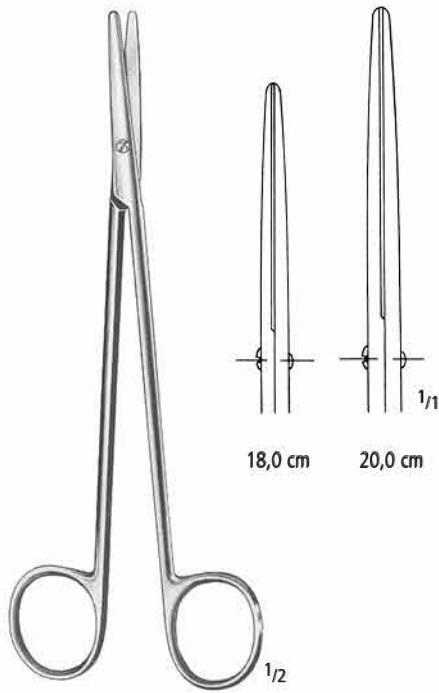

**METZENBAUM-NELSON**

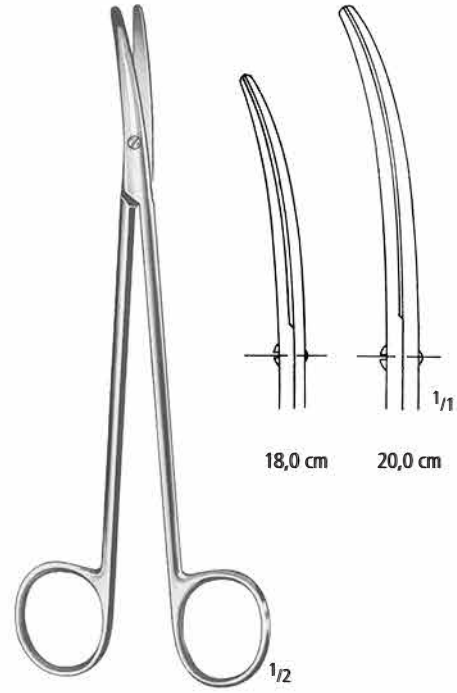

**METZENBAUM-NELSON**



Fig. 1

Fig. 2

Fig. 3

18,0 cm/7"	<b>AC 110/18*</b>	<b>AC 111/18*</b>	<b>AC 120/18</b>	<b>AC 121/18</b>	<b>AC 130/18</b>	<b>AC 131/18</b>
20,0 cm/8"	<b>AC 110/20*</b>	<b>AC 111/20*</b>	<b>AC 120/20</b>	<b>AC 121/20</b>	<b>AC 130/20</b>	<b>AC 131/20</b>

AA  
AB  
**AC**  
AD  
AE  
AF  
AK  
AL  
AO  
AP  
AR  
KA  
KL  
KM  
KO  
KU  
KYE  
X

Präparierscheren, DELICATE  
 Dissecting Scissors, DELICATE  
 Tijeras para preparaciones, DELICATE  
 Ciseaux à dissection, DELICATE  
 Forbici per preparazioni, DELICATE

**METZENBAUM-DELICATE**

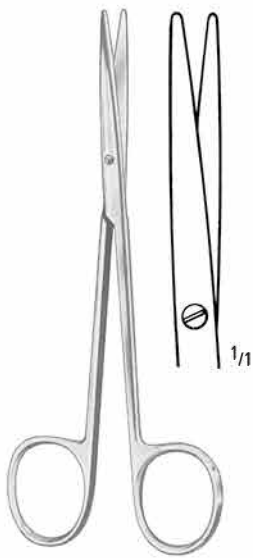

Fig. 1  
**AC 140/14\***  
 14,5 cm/5<sup>3</sup>/<sub>4</sub>"

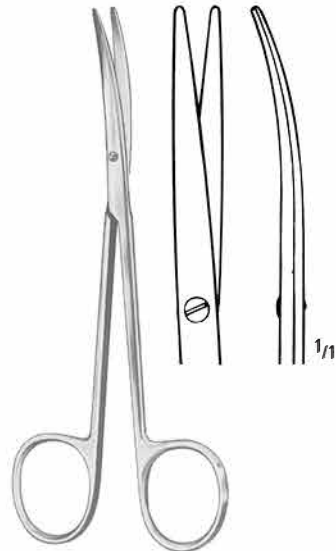

Fig. 1  
**AC 141/14\***  
 14,5 cm/5<sup>3</sup>/<sub>4</sub>"

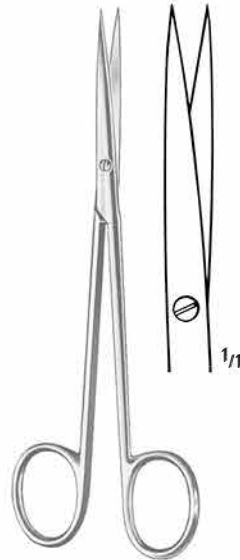

Fig. 3  
**AC 142/14**  
 14,5 cm/5<sup>3</sup>/<sub>4</sub>"

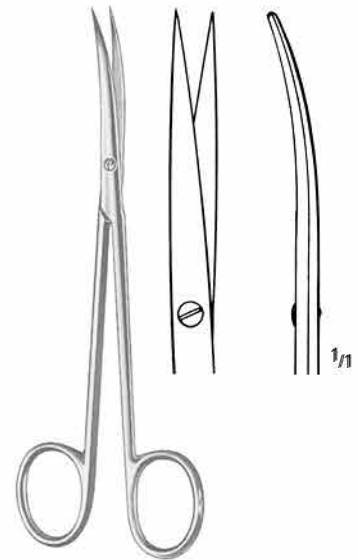

Fig. 3  
**AC 143/14**  
 14,5 cm/5<sup>3</sup>/<sub>4</sub>"

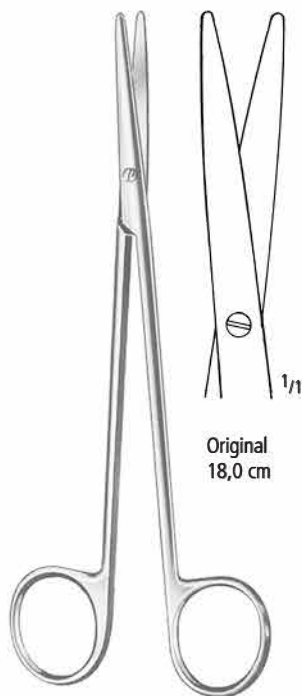

Fig. 1

18,0 cm/7"  
 20,0 cm/8"

**AC 150/18\***  
**AC 150/20**

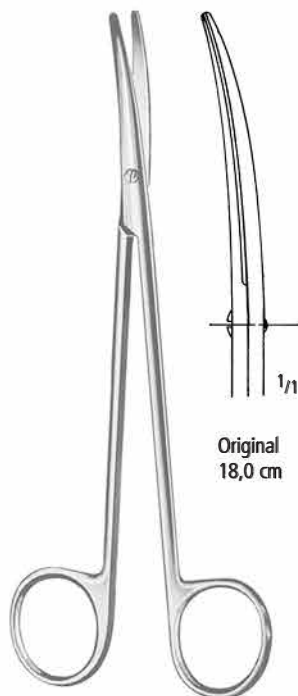

Fig. 1

**AC 151/18\***  
**AC 151/20**

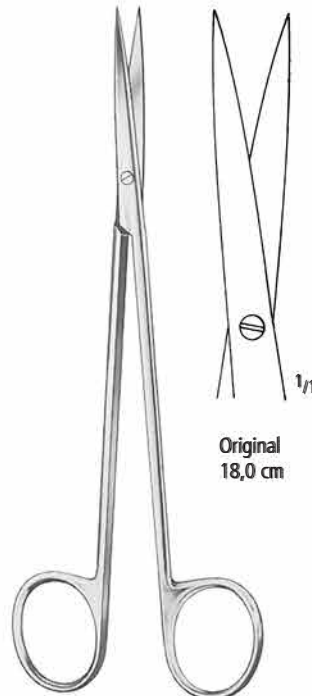

Fig. 3

**AC 152/18**  
**AC 152/20**

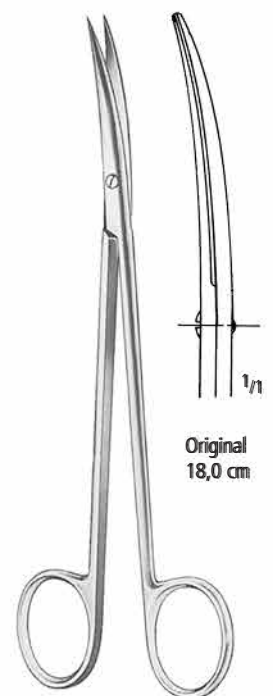

Fig. 3

**AC 153/18**  
**AC 153/20**



SCHEREN SCISSORS TIJERAS CISEAUX FORBICI

Face-Lift Scheren  
 Face-Lift Scissors  
 Tijeras para Face-Lift  
 Ciseaux à Face-Lift  
 Forbici per Face-Lift



**TREPSAT**  
 18,0 cm/7"



**AC 160/05**  
 5,0 mm



**AC 160/08**  
 8,0 mm



**AC 160/15**  
 15,0 mm

Original 19,0 cm

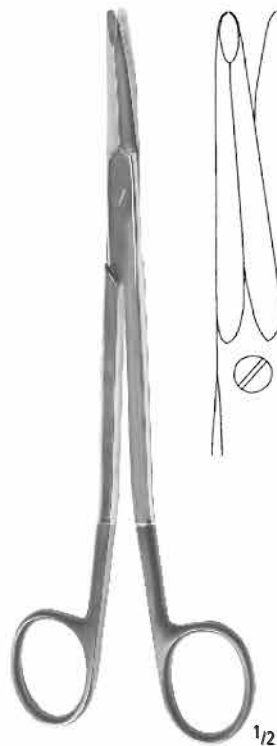

**FREEMAN-GORNEY**

gebogen  
 curved  
 curvas  
 courbes  
 curve

- AC 163/17** 17,0 cm/6<sup>3</sup>/<sub>4</sub>"
- AC 163/19** 19,0 cm/7<sup>1</sup>/<sub>2</sub>"
- AC 163/23** 23,0 cm/9"

AA  
 AB  
**AC**  
 AD  
 AE  
 AF  
 AK  
 AL  
 AO  
 AP  
 AR  
 KA  
 KL  
 KM  
 KO  
 KU  
 KYE  
 X

**AC** SCHEREN SCISSORS TIJERAS CISEAUX FORBICI

Präparierscheren  
Dissecting Scissors  
Tijeras para preparaciones  
Ciseaux à dissection  
Forbici per preparazioni

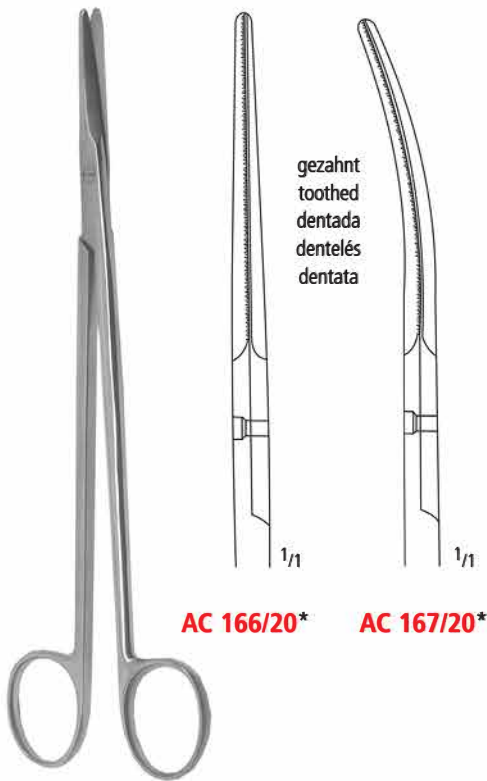

**AC 166/20\***      **AC 167/20\***

**GORNEY**  
19,5 cm/7<sup>3</sup>/<sub>4</sub>"

gezahnt  
toothed  
dentada  
dentelés  
dentata

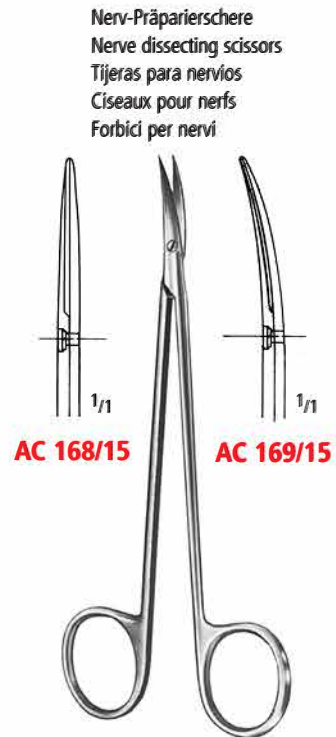

**AC 168/15**      **AC 169/15**

15,0 cm/6"

Nerv-Präparierschere  
Nerve dissecting scissors  
Tijeras para nervios  
Ciseaux pour nerfs  
Forbici per nervi



**LEXER**  
**AC 170/16\***  
16,0 cm/6<sup>1</sup>/<sub>4</sub>"

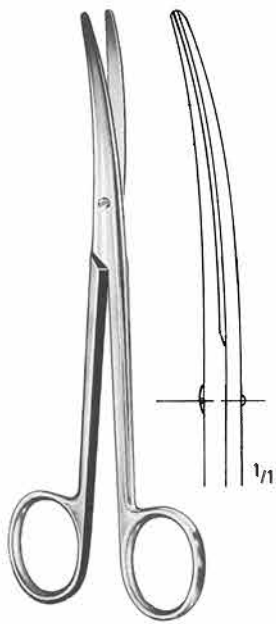

**LEXER**  
**AC 171/16\***  
16,0 cm/6<sup>1</sup>/<sub>4</sub>"

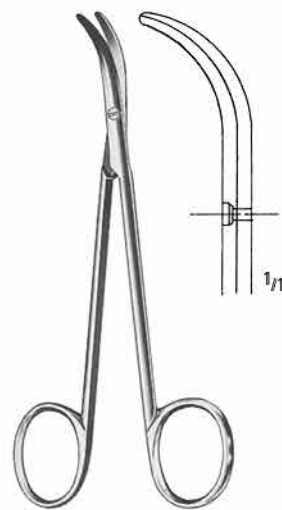

**FOMON**  
**AC 173/13**  
13,5 cm/5<sup>1</sup>/<sub>4</sub>"

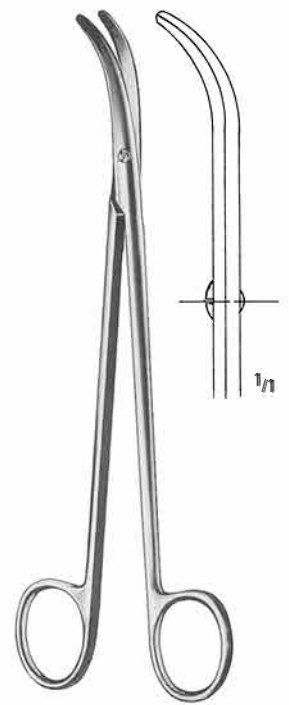

**THOREK**  
**AC 175/19**  
19,0 cm/7<sup>1</sup>/<sub>2</sub>"

SCHEREN SCISSORS TIJERAS CISEAUX FORBICI

Präparierscheren  
Dissecting Scissors  
Tijeras para preparaciones  
Ciseaux à dissection  
Forbici per preparazioni



**LEXER-BABY**  
**AC 176/10**  
10,0 cm/4"

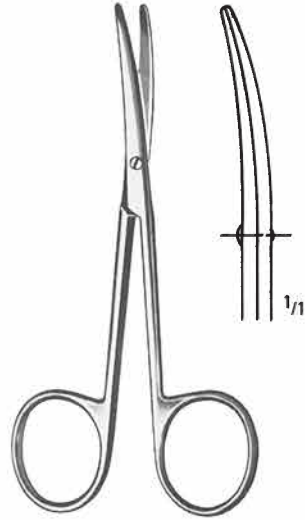

**LEXER-BABY**  
**AC 177/10**  
10,0 cm/4"



**AC 200/14**  
14,0 cm/5½"

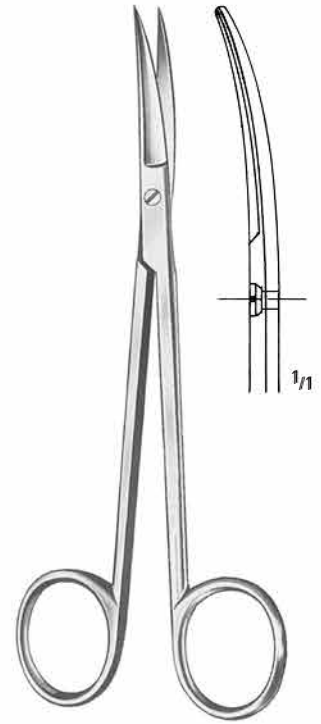

**SANVENERO**

**AC 201/14**  
14,0 cm/5½"



**AC 204/14\***  
14,0 cm/5½"

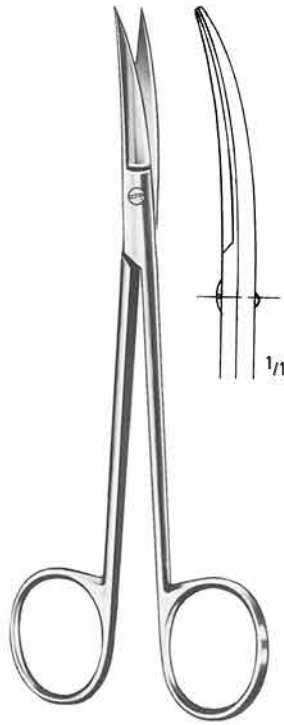

**JOSEPH**

**AC 205/14\***  
14,0 cm/5½"



**AC 208/12\***  
**AC 208/15**  
**AC 208/18**  
**AC 208/20**

**KILNER (RAGNELL)**

12,0 cm/4¾"  
15,0 cm/6"  
18,0 cm/7"  
20,0 cm/8"

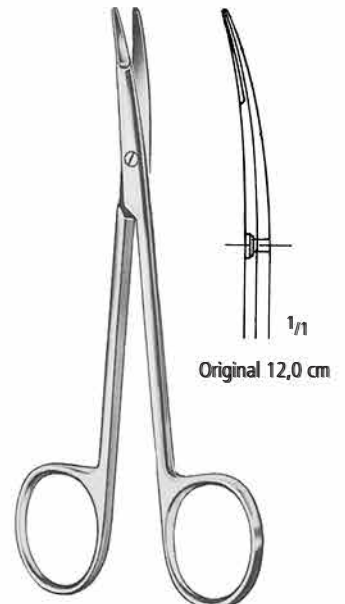

**AC 210/12\***  
**AC 210/15**  
**AC 210/18**  
**AC 210/20**

Original 12,0 cm

AA  
AB  
AC  
AD  
AE  
AF  
AK  
AL  
AO  
AP  
AR  
KA  
KL  
KM  
KO  
KU  
KYE  
X

**AC** SCHEREN SCISSORS TIJERAS CISEAUX FORBICI

Präparierscheren, Tonsillenscheren  
 Dissecting Scissors, Tonsil Scissors  
 Tijeras para preparaciones, Tijeras para amígdalas  
 Ciseaux à dissection, Ciseaux pour les amygdales  
 Forbici per preparazioni, Forbici per tonsille

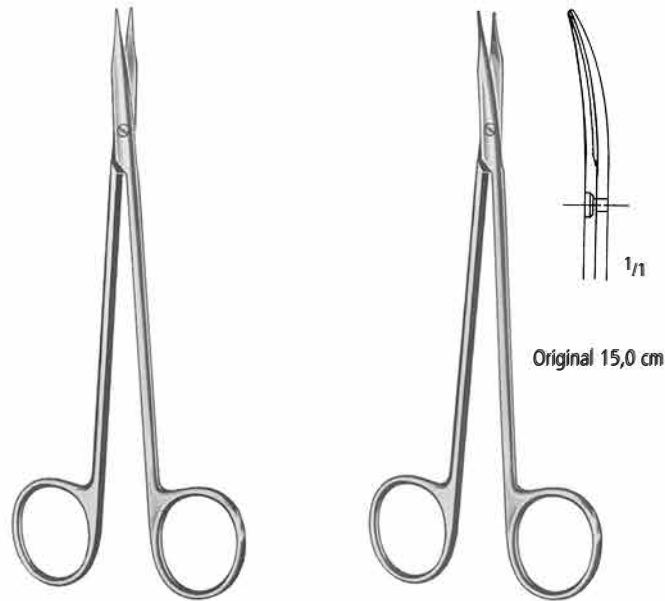

**REYNOLDS**  
**AC 214/15\*** 15,0 cm/6"  
**AC 214/18\*** 18,0 cm/7"  
**AC 215/15\***  
**AC 215/18\***



**PRINCE**  
**AC 301/17**  
 17,5 cm/7"

**BÖTTCHER**  
**AC 302/18**  
 18,0 cm/7"

**GOOD**  
**AC 303/19**  
 19,0 cm/7½"

**GOOD-SCHWECKENDICK**  
**AC 304/19**  
 19,0 cm/7½"

gezahnt  
 saw edge  
 dentadas  
 dentelés  
 dentata

SCHEREN SCISSORS TIJERAS CISEAUX FORBICI

Nasenscheren, Kropfschere  
 Nasal Scissors, Goitre Enucleation Scissors  
 Tijeras nasales, Tijeras para bocio  
 Ciseaux nasaux, Ciseaux à goître  
 Forbici nasali, Forbici per gozzo

**AC 306/22**

gerade  
 straight  
 rectas  
 droits  
 rette

**AC 307/22**

gebogen  
 curved  
 curvas  
 courbes  
 curve



**SCHOEMAKER**  
**AC 305/15**  
 15,0 cm/6"

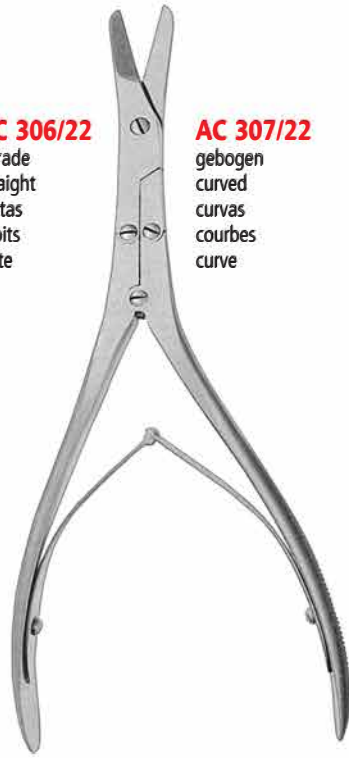

**CAPLAN**  
 22,0 cm/9"

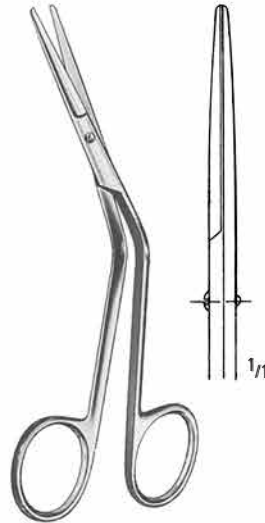

**FOMON**  
**AC 309/13**  
 13,5 cm/5<sup>1</sup>/<sub>4</sub>"

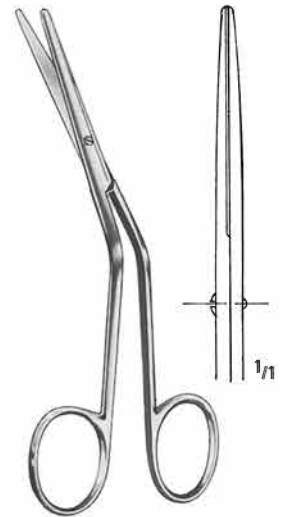

**FOMON**  
**AC 310/13**  
 13,5 cm/5<sup>1</sup>/<sub>4</sub>"

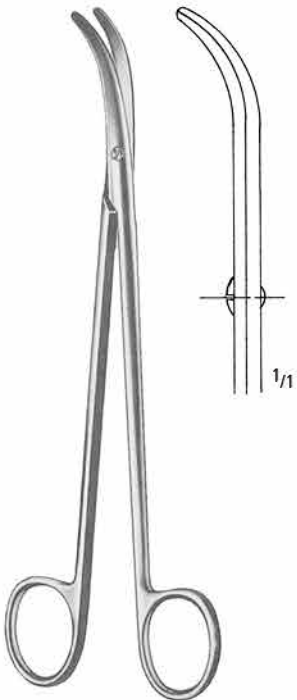

**HALLE**  
**AC 313/19**  
 19,0 cm/7<sup>1</sup>/<sub>2</sub>"

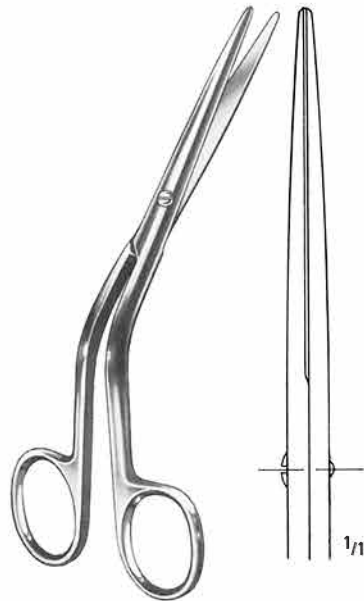

**COTTLE**  
**AC 315/16**  
 16,0 cm/6<sup>1</sup>/<sub>4</sub>"



**HEYMANN**  
**AC 317/18**  
 18,0 cm/7"

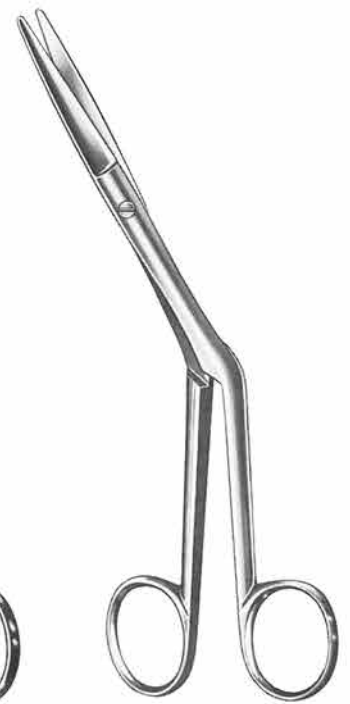

**HEYMANN**  
**AC 318/19**  
 19,5 cm/7<sup>3</sup>/<sub>4</sub>"

AA  
 AB  
**AC**  
 AD  
 AE  
 AF  
 AG  
 AH  
 AI  
 AJ  
 AK  
 AL  
 AM  
 AN  
 AO  
 AP  
 AQ  
 AR  
 AS  
 AT  
 AU  
 AV  
 AW  
 AX



**AC** SCHEREN SCISSORS TIJERAS CISEAUX FORBICI

Feine chirurgische Scheren  
 Fine Operating Scissors  
 Tijeras finas para cirugía  
 Ciseaux fins à chirurgie  
 Forbici fini per chirurgia

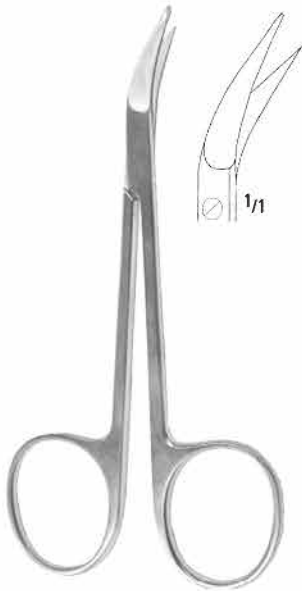

**PERWITZSCHKY**  
**AC 403/11**  
 11,0 cm/4 1/2"

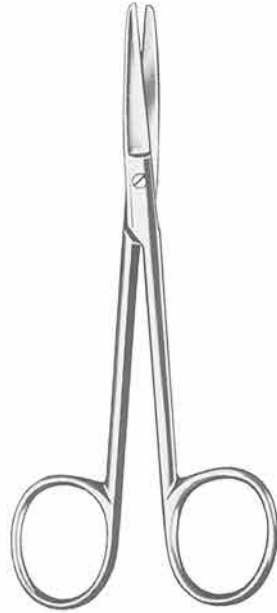

**WAGNER**  
 12,0 cm/4 3/4"

gerade  
 straight  
 rectas  
 droits  
 rette



**Fig. 1**  
**AC 404/01**



**Fig. 2**  
**AC 404/02**



**Fig. 3**  
**AC 404/03**

gebogen  
 curved  
 curvas  
 courbes  
 curve



**Fig. 1**  
**AC 405/01**



**Fig. 2**  
**AC 405/02**



**Fig. 3**  
**AC 405/03**



**AC 408/11\***  
 11,0 cm/4 1/3"



**AC 409/11\***  
 11,0 cm/4 1/3"

SCHEREN SCISSORS TIJERAS CISEAUX FORBICI

Feine Scheren  
 Fine Scissors  
 Tijeras finas  
 Ciseaux fins  
 Forbici fini

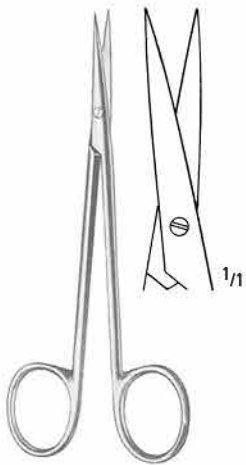

**AC 410/11**  
 11,5 cm/4 1/2"

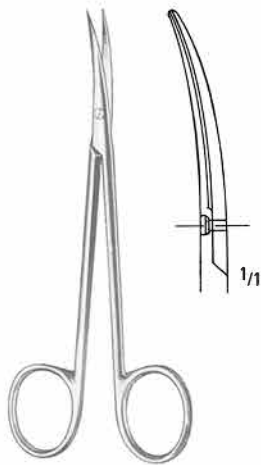

**AC 411/11**  
 11,5 cm/4 1/2"

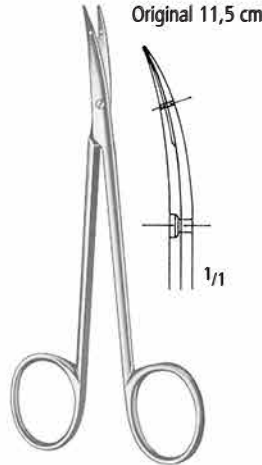

**LITTLER**  
**AC 412/11** 11,5 cm/4 1/2"  
**AC 412/14** 14,0 cm/5 1/2"

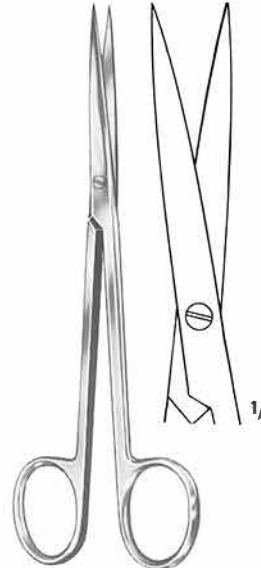

**BROPHY (SULLIVAN)**  
**AC 414/14**  
 14,5 cm/5 3/4"

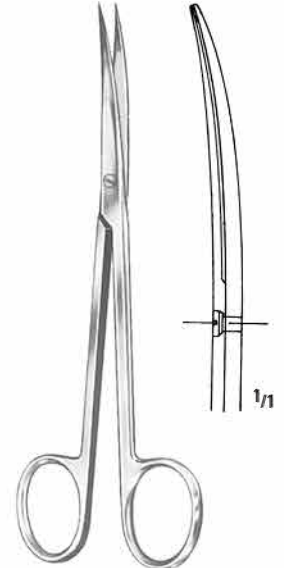

**AC 415/14**  
 14,5 cm/5 3/4"

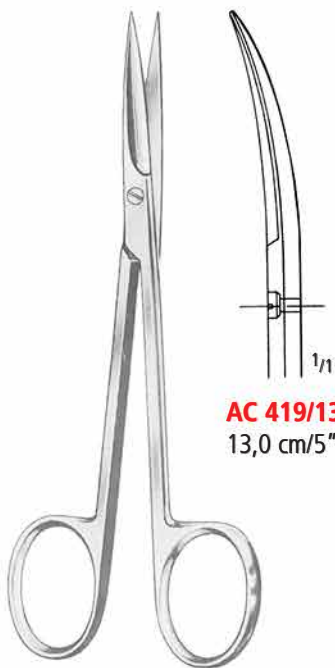

**AC 419/13**  
 13,0 cm/5"



**AC 422/10** 10,5 cm/4 1/4"  
**AC 422/11** 11,5 cm/4 1/2"

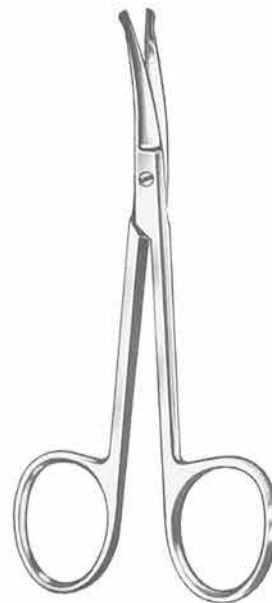

**AC 423/10**  
**AC 423/11**



**AC 424/11**  
 11,5 cm/4 1/2"

AA  
 AB  
**AC**  
 AD  
 AE  
 AF  
 AG  
 AH  
 AI  
 AJ  
 AK  
 AL  
 AM  
 AN  
 AO  
 AP  
 AQ  
 AR  
 AS  
 AT  
 AU  
 AV  
 AW  
 AX

**AC** SCHEREN SCISSORS TIJERAS CISEAUX FORBICI

Feine Scheren  
 Fine Scissors  
 Tijeras finas  
 Ciseaux fins  
 Forbici fini

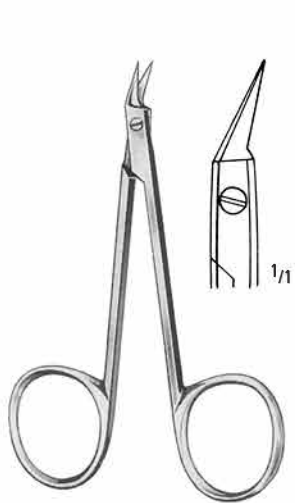

**O'BRIEN**  
**AC 427/09**  
 9,0 cm/3 1/2"

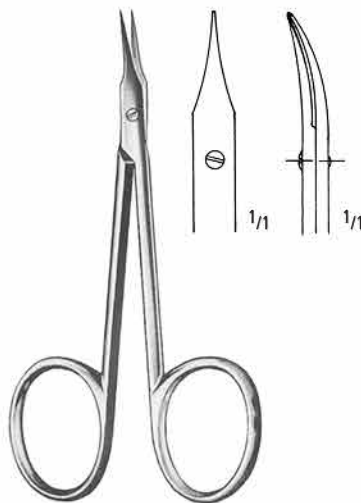

**WALTON**  
**AC 429/10**  
 10,0 cm/4"

sehr fein  
 extra delicate  
 muy finas  
 très fin  
 molto sottile

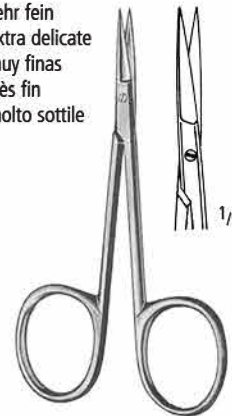

**MOD. BONN**  
**AC 430/08**  
 8,0 cm/3"

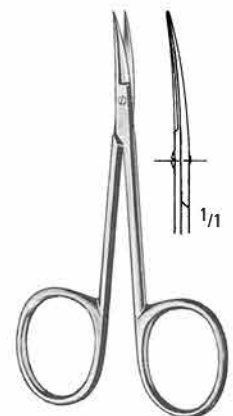

**AC 431/08**  
 8,0 cm/3"

Irisscheren  
 Iris Scissors  
 Tijeras para iridectomía  
 Ciseaux à iridectomie  
 Forbici per iridectomia

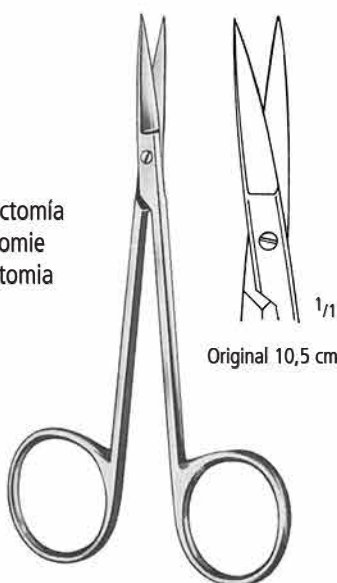

Original 10,5 cm

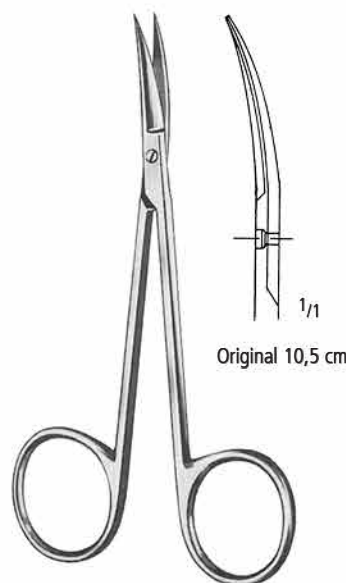

Original 10,5 cm



**WILMER**  
**AC 471/10**  
 10,0 cm/4"

9,0 cm/3 1/2"	<b>AC 450/09</b>	<b>AC 451/09</b>
10,5 cm/4 1/4"	<b>AC 450/10</b>	<b>AC 451/10</b>
11,5 cm/4 1/2"	<b>AC 450/11*</b>	<b>AC 451/11*</b>

SCHEREN SCISSORS TIJERAS CISEAUX FORBICI

Feine Scheren, Ligaturscheren  
 Fine Scissors, Ligature Scissors  
 Tijeras finas, Tijeras para ligaduras  
 Ciseaux fins, Ciseaux à ligatures  
 Forbici fini, Forbici per legatura

AA  
AB  
AC  
AD  
AE  
AF  
AG  
AH  
AI  
AJ  
AK  
AL  
AM  
AN  
AO  
AP  
AQ  
AR  
AS  
AT  
AU  
AV  
AW  
AX

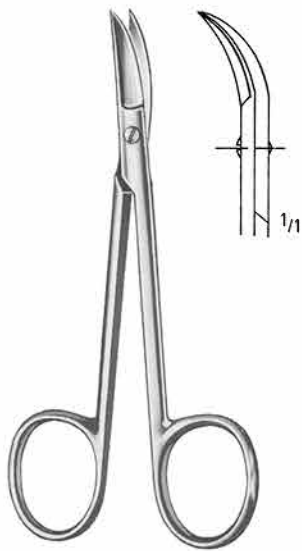

**CHADWICK**  
**AC 473/11**  
 11,0 cm/4<sup>1</sup>/<sub>3</sub>"



**STEVENS**  
 10,5 cm/4<sup>1</sup>/<sub>4</sub>"  
 11,5 cm/4<sup>1</sup>/<sub>2</sub>"

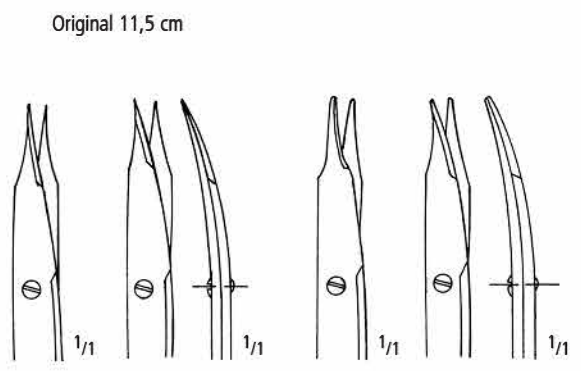

spitz pointed agudas pointues acuta	gebogen curved curvas courbes curve	stumpf blunt romas mousses smussa	gebogen curved curvas courbes curve
gerade straight rectas droits rette		gerade straight rectas droits rette	

**AC 474/10**   **AC 475/10**   **AC 476/10**   **AC 477/10**  
**AC 474/11**   **AC 475/11**   **AC 476/11\***   **AC 477/11\***



**SPENCER**  
 9,0 cm/3<sup>1</sup>/<sub>2</sub>"   **AC 500/09**  
 10,5 cm/4<sup>1</sup>/<sub>4</sub>"   **AC 500/10**  
 12,5 cm/5"   **AC 500/13**



**SPENCER-DELICATE**  
**AC 501/11**  
 11,0 cm/4<sup>1</sup>/<sub>3</sub>"



**LITTAUER**  
**AC 502/14**  
 14,0 cm/5<sup>1</sup>/<sub>2</sub>"



**AC 503/16**  
 16,0 cm/6<sup>1</sup>/<sub>4</sub>"

\* Auch erhältlich als SC   \* Also available as SC

Ligaturscheren  
Ligature Scissors  
Tijeras para ligaduras  
Ciseaux à ligatures  
Forbici per legatura



**SHORTBENT**  
**AC 513/09**  
9,0 cm/3 1/2"



**NORTHBENT**  
**AC 514/12**  
12,5 cm/5"

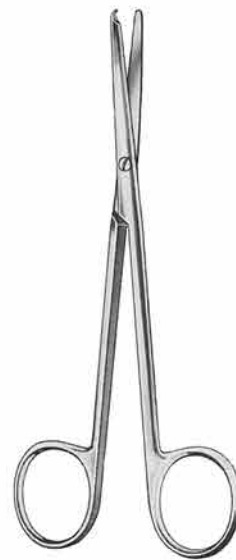

**BUCK**  
14,5 cm/5 3/4" **AC 516/14**  
18,0 cm/7" **AC 516/18**



SCHEREN SCISSORS TIJERAS CISEAUX FORBICI

Mikroscheren  
Micro Scissors  
Micro Tijeras  
Micro Ciseaux  
Micro Forbici

- >> Alle unsere Mikroscheren werden von Fachkräften mit jahrelanger Erfahrung hergestellt. Die Endkontrolle findet unter dem Mikroskop statt. Um Ihnen ein ermüdungsfreies Arbeiten zu ermöglichen, wird dem Federdruck größte Aufmerksamkeit gewidmet.
- >> Bitte wählen Sie unter Rund- oder Flachgriffscheren.

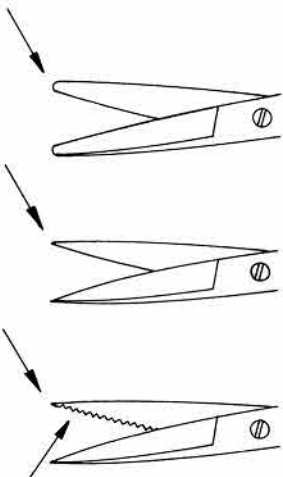

**Dissection:** **Gebogene Blätter, abgerundete Spitzen** ermöglichen eine gute und sichere Dissektion, ohne Nerven und Blutgefäße zu beschädigen.

**Adventitia:** **Gerade Blätter, sehr scharfe Spitzen** gewährleisten präzises Anfrischen von Gefäßenden.

**Nerve:** Ein Blatt ist **fein gezahnt**, um ein Herausgleiten des Nervs zu vermeiden.

- >> All our Micro Scissors are manufactured by skilled craftsmen with many years of experience. Final inspection is carried out under a microscope. Careful attention is paid to the closing pressure of the spring handle, to ensure precise work during surgeries, without fatigue.
- >> Round or flat handle scissors according to your preference.

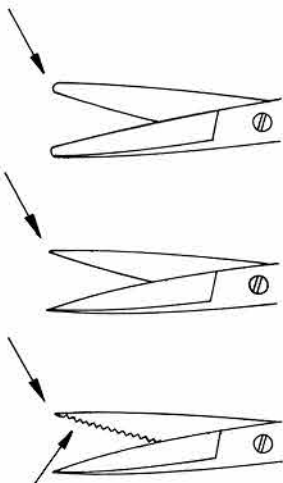

**Dissection:** **Curved blades, slightly rounded tips** ensure safe dissection without damage to nerves and vessels.

**Adventitia:** **Straight blades, very sharp tips** for finest trimming of vessel ends.

**Nerve:** One blade is **fine-toothed** to avoid slipping of the nerve.

AA  
AB  
AC  
AD  
AE  
AF  
AK  
AL  
AO  
AP  
AR  
KA  
KL  
KM  
KO  
KU  
KYE  
X

Mikroscheren  
Micro Scissors  
Micro Tijeras  
Micro Ciseaux  
Micro Forbici



14,5 cm/5¾"



**Dissection  
AC 801/15**

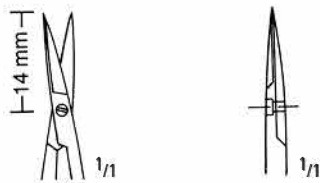

**Adventitia  
AC 803/15**



18,0 cm/7"



**Dissection  
AC 801/18**

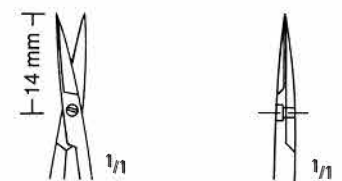

**Adventitia  
AC 803/18**

SCHEREN SCISSORS TIJERAS CISEAUX FORBICI

Mikroscheren  
Micro Scissors  
Micro Tijeras  
Micro Ciseaux  
Micro Forbici



**AC 807/14**  
14,5 cm/5<sup>3</sup>/<sub>4</sub>"



**AC 812/18**  
18,0 cm/7"



**AC 817/18**  
18,0 cm/7"

AA  
AB  
**AC**  
AD  
AE  
AF  
AK  
AL  
AO  
AP  
AR  
KA  
KL  
KM  
KO  
KU  
KYE  
X

**AC** SCHEREN SCISSORS TIJERAS CISEAUX FORBICI

Mikroscheren  
Micro Scissors  
Micro Tijeras  
Micro Ciseaux  
Micro Forbici



11,0 cm/4 1/3"

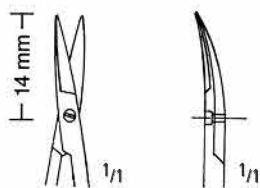

**Dissection  
AC 821/11**

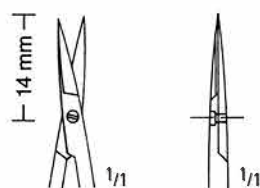

**Adventitia  
AC 830/11**

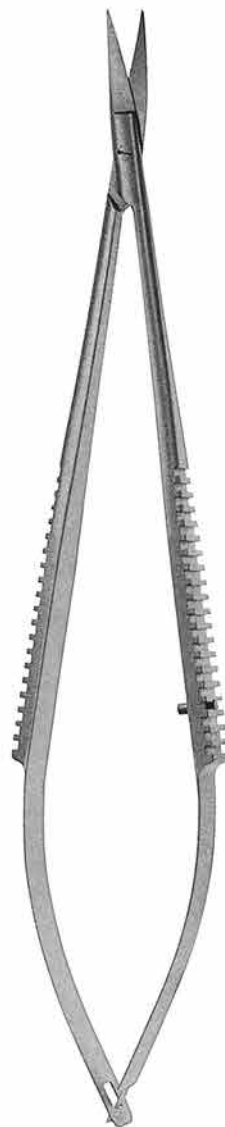

15,0 cm/6"

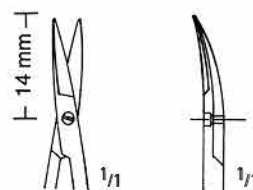

**Dissection  
AC 823/15**

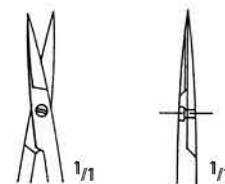

**Adventitia  
AC 832/15**

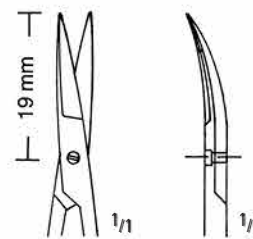

**Dissection  
AC 825/15**

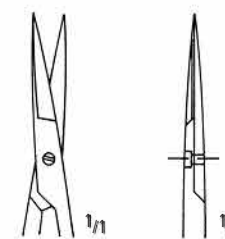

**Adventitia  
AC 834/15**

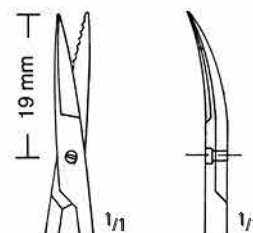

**Dissection  
AC 827/15**

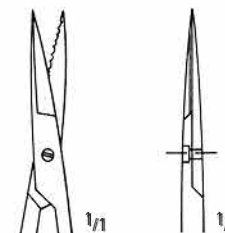

**Adventitia  
AC 836/15**

>> Nerve >>

SCHEREN SCISSORS TIJERAS CISEAUX FORBICI

Mikroscheren  
Micro Scissors  
Micro Tijeras  
Micro Ciseaux  
Micro Forbici

AA  
AB  
AC  
AD  
AE  
AF  
AK  
AL  
AO  
AP  
AR  
KA  
KL  
KM  
KO  
KU  
KYE  
X



18,5 cm/7<sup>1</sup>/<sub>3</sub>"

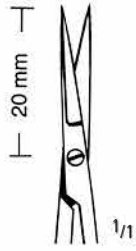

AC 850/19



AC 851/19



16,0 cm/6<sup>1</sup>/<sub>4</sub>"  
20,0 cm/8"



AC 860/16  
AC 860/20



AC 861/16  
AC 861/20



AC 862/16  
AC 862/20



AC 863/16  
AC 863/20



AC 864/16  
AC 864/20



AC 865/16  
AC 865/20



**AC** SCHEREN SCISSORS TIJERAS CISEAUX FORBICI

Mikroscheren  
Micro Scissors  
Micro Tijeras  
Micro Ciseaux  
Micro Forbici



18,0 cm/7"



**AC 870/01**  
25°



**AC 870/02**  
45°



**AC 870/03**  
60°

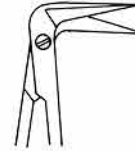

**AC 870/04**  
90°

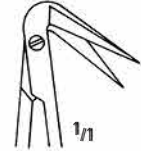

**AC 870/05**  
125°



18,0 cm/7"



**AC 871/01**  
25°



**AC 871/02**  
45°

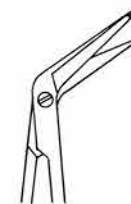

**AC 871/03**  
60°



**AC 871/04**  
90°

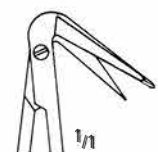

**AC 871/05**  
125°

# nopa® TUC® SC Super Cut

**SUPER CUT TUC**



## Besonderheit:

Nutzen Sie die Vorteile von Hartmetalleinsätzen.

**nopa TUC Super Cut** Scheren haben eine rasierklingenscharfe Schneide, kombiniert mit einer mikrogezahnten Schneide.

>> Diese Scheren sind durch einen glänzenden und einen vergoldeten Ring gekennzeichnet.

## Features:

Use the advantages of Tungsten Carbide.

**nopa TUC Super Cut** scissors have a razor-like edge combined with one micro serrated blade.

>> these scissors are characterized by a shiny and a gold ring.

## Verfügbare Modelle / Available Patterns

Im Katalog durch \* markiert. / Marked in the catalog with \* .

AC 910/14 SC	MAYO Dissecting Scissors, TUC, straight, blunt/blunt, 14.5 cm SC
AC 910/17 SC	MAYO Dissecting Scissors, TUC, straight, blunt/blunt, 17.0 cm SC
AC 911/14 SC	MAYO Dissecting Scissors, TUC, curved, blunt/ blunt, 14.5 cm SC
AC 911/17 SC	MAYO Dissecting Scissors, TUC, curved, blunt/blunt, 17.0 cm SC
AC 916/15 SC	MAYO-STILLE Scissors, TUC, straight, blunt/blunt, 15.0 cm SC
AC 917/15 SC	MAYO-STILLE Scissors, TUC, curved, blunt/blunt, 15.0 cm SC
AC 930/14 SC	METZENBAUM Scissors, TUC, straight, blunt/blunt, 14.5 cm SC
AC 931/14 SC	METZENBAUM Scissors, TUC, curved, blunt/blunt, 14.5 cm SC
AC 940/18 SC	METZENBAUM Scissors, TUC, straight, blunt/blunt, 18.0 cm SC
AC 940/20 SC	METZENBAUM Scissors, TUC, straight, blunt/blunt, 20.0 cm SC
AC 941/18 SC	METZENBAUM Scissors, TUC, curved, blunt/blunt, 18.0 cm SC
AC 941/20 SC	METZENBAUM Scissors, TUC, curved, 20.0 cm SC
AC 960/14 SC	METZENBAUM-DELIC. Scissors, TUC, straight, blunt/blunt, 14.5 cm SC
AC 961/14 SC	METZENBAUM-DELIC. Scissors, TUC, curved, blunt/blunt, 14.5 cm SC
AC 970/18 SC	METZENBAUM-DELIC. Scissors, TUC, straight, blunt 18.0 cm SC
AC 970/20 SC	METZENBAUM-DELIC. Scissors, TUC, straight, blunt, 20.0 cm SC
AC 971/18 SC	METZENBAUM-DELIC. Scissors, TUC, curved, blunt, 18.0 cm SC
AC 971/20 SC	METZENBAUM-DELIC. Scissors, TUC, curved, blunt, 20.0 cm SC
AC 974/11 SC	STEVENS Tenotomy Scissors, TUC, straight, pointed, 11.5 cm SC
AC 975/11 SC	STEVENS Tenotomy Scissors, TUC, curved, pointed, 11.5 cm SC
AC 984/11 SC	Iris Scissors, TUC, straight, sharp, 11.5 cm SC
AC 985/11 SC	Iris Scissors, TUC, curved, sharp, 11.5 cm SC

**AC** SCHEREN SCISSORS TIJERAS CISEAUX FORBICI

Scheren mit Hartmetalleinlagen  
 Scissors with Tungsten Carbide Inserts  
 Tijeras con filos de carburo de tungsteno  
 Ciseaux avec plaquettes en carbure de tungstène  
 Forbici con taglio al carburo di tungsteno

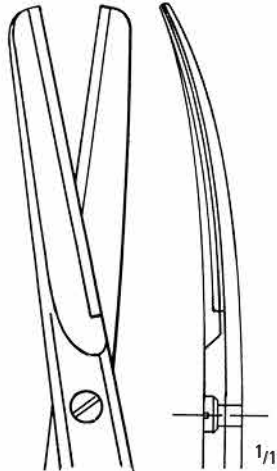

**STANDARD**  
 Fig. 1

straight: 14,5 cm/5<sup>3</sup>/<sub>4</sub>"  
**AC 900/14**  
 curved: **AC 901/14**

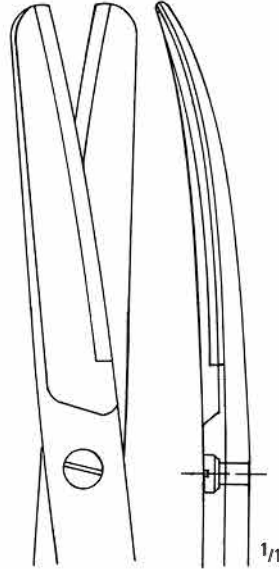

16,5 cm/6<sup>1</sup>/<sub>2</sub>"  
**AC 900/16**  
**AC 901/16**

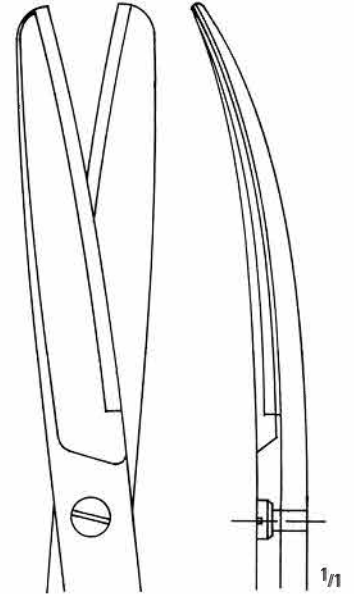

18,5 cm/7<sup>1</sup>/<sub>3</sub>"  
**AC 900/18**  
**AC 901/18**

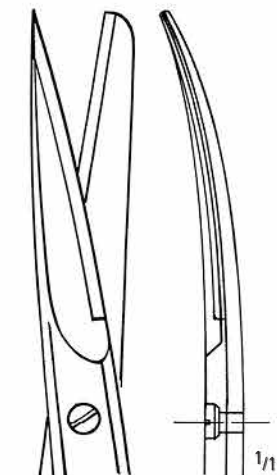

**STANDARD**  
 Fig. 2

straight: 14,5 cm/5<sup>3</sup>/<sub>4</sub>"  
**AC 902/14**  
 curved: **AC 903/14**

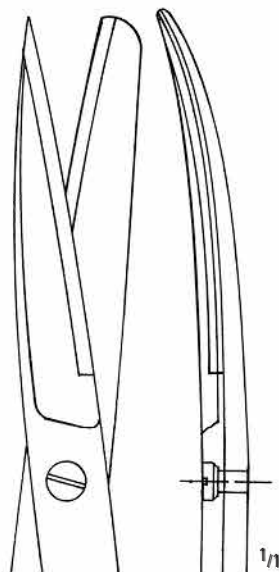

16,5 cm/6<sup>1</sup>/<sub>2</sub>"  
**AC 902/16**  
**AC 903/16**

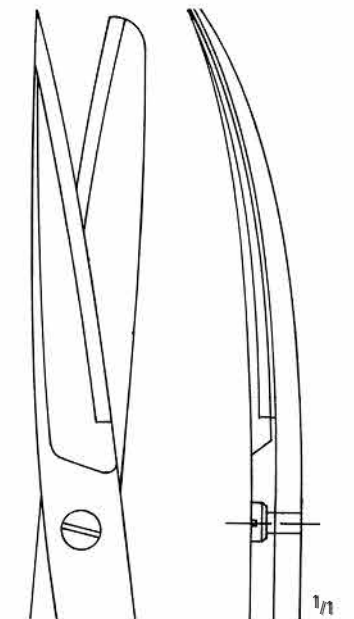

18,5 cm/7<sup>1</sup>/<sub>3</sub>"  
**AC 902/18**  
**AC 903/18**

SCHEREN SCISSORS TIJERAS CISEAUX FORBICI

Scheren mit Hartmetalleinlagen  
 Scissors with Tungsten Carbide Inserts  
 Tijeras con filos de carburo de tungsteno  
 Ciseaux avec plaquettes en carbure de tungstène  
 Forbici con taglio al carburo di tungsteno

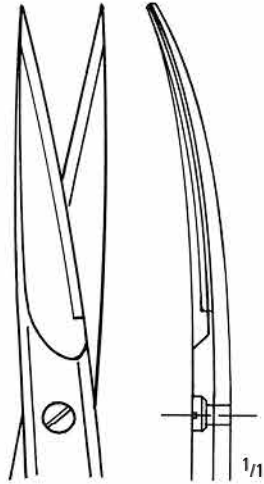
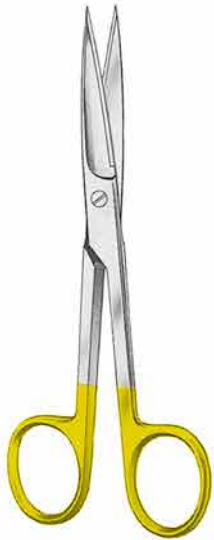

**STANDARD**  
 Fig. 3

straight: 14,5 cm/5<sup>3</sup>/<sub>4</sub>"  
**AC 904/14**  
 curved: **AC 905/14**

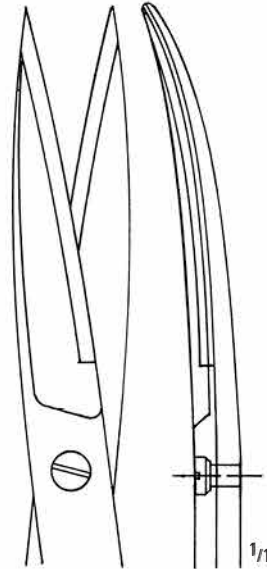

16,5 cm/6<sup>1</sup>/<sub>2</sub>"  
**AC 904/16**  
**AC 905/16**

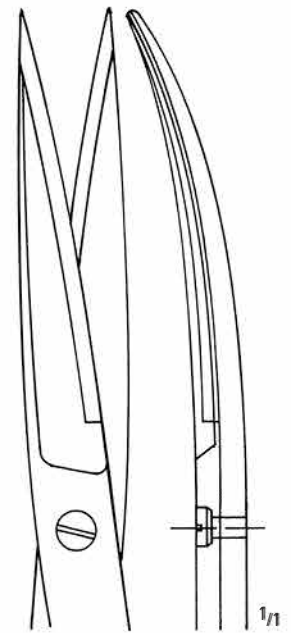

18,5 cm/7<sup>1</sup>/<sub>3</sub>"  
**AC 904/18**  
**AC 905/18**

nopa<sup>®</sup>  
**TUE**

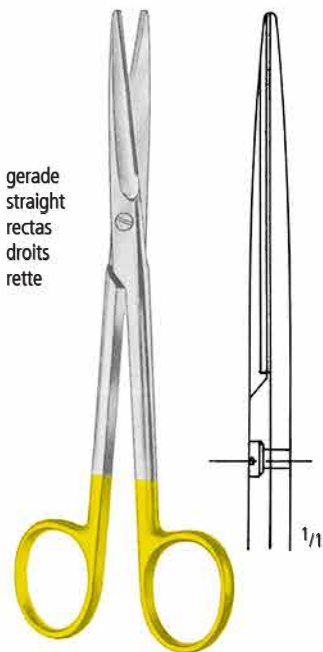

gerade  
 straight  
 rectas  
 droits  
 rette

**MAYO**  
**AC 910/14\***  
**AC 910/17\***

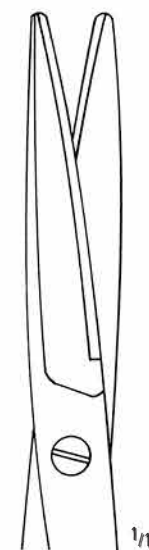

Original 17,0 cm

14,5 cm/5<sup>1</sup>/<sub>2</sub>"  
 17,0 cm/6<sup>3</sup>/<sub>4</sub>"

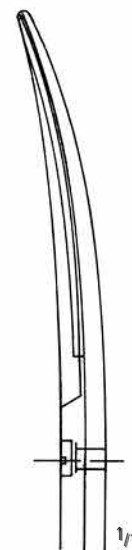

gebogen  
 curved  
 curvas  
 courbes  
 curve

**MAYO**  
**AC 911/14\***  
**AC 911/17\***

AA  
 AB  
**AC**  
 AD  
 AE  
 AF  
 AG  
 AH  
 AI  
 AJ  
 AK  
 AL  
 AM  
 AN  
 AO  
 AP  
 AQ  
 AR  
 AS  
 AT  
 AU  
 AV  
 AW  
 AX



**AC** SCHEREN SCISSORS TIJERAS CISEAUX FORBICI

Scheren mit Hartmetalleinlagen  
 Scissors with Tungsten Carbide Inserts  
 Tijeras con filos de carburo de tungsteno  
 Ciseaux avec plaquettes en carbure de tungstène  
 Forbici con taglio al carburo di tungsteno



**MAYO-STILLE**  
**AC 916/15\***  
**AC 916/17**

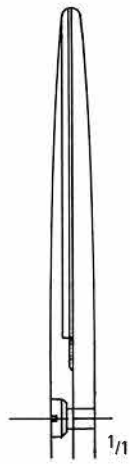

Original 17,0 cm

15,0 cm/6"  
 17,0 cm/6<sup>3</sup>/<sub>4</sub>"

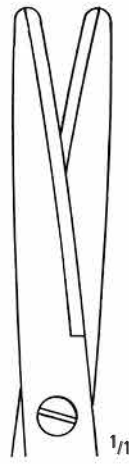

**MAYO-STILLE**  
**AC 917/15\***  
**AC 917/17**

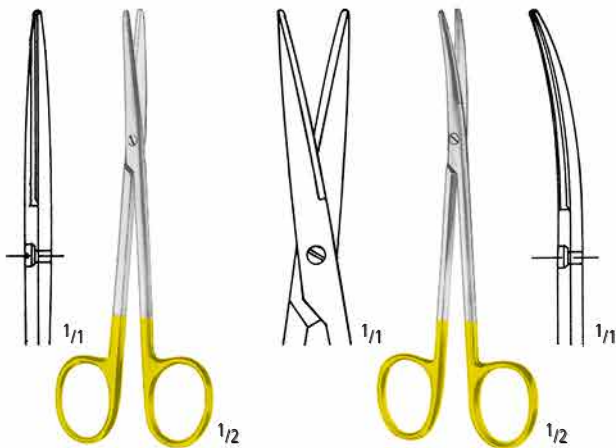

**AC 922/11**  
 11,5 cm/4<sup>1</sup>/<sub>2</sub>"

**METZENBAUM**

**AC 923/11**  
 11,5 cm/4<sup>1</sup>/<sub>2</sub>"

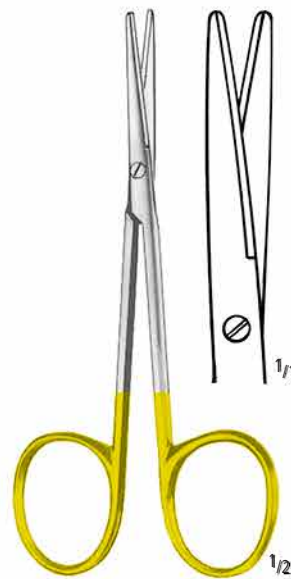

**AC 930/14\***  
 14,5 cm/5<sup>3</sup>/<sub>4</sub>"

**METZENBAUM**

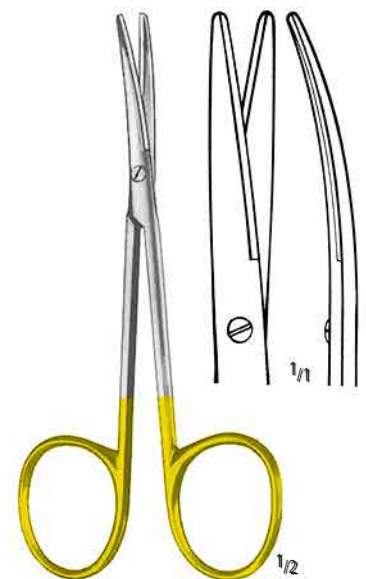

**AC 931/14\***  
 14,5 cm/5<sup>3</sup>/<sub>4</sub>"



SCHEREN SCISSORS TIJERAS CISEAUX FORBICI

Scheren mit Hartmetalleinlagen  
 Scissors with Tungsten Carbide Inserts  
 Tijeras con filos de carburo de tungsteno  
 Ciseaux avec plaquettes en carbure de tungstène  
 Forbici con taglio al carburo di tungsteno

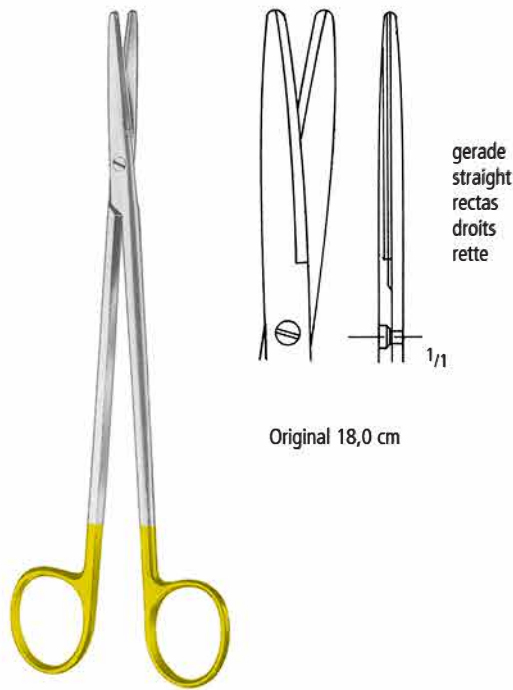

Original 18,0 cm

**METZENBAUM**

18,0 cm/7"

**AC 940/18\***

20,0 cm/8"

**AC 940/20\***

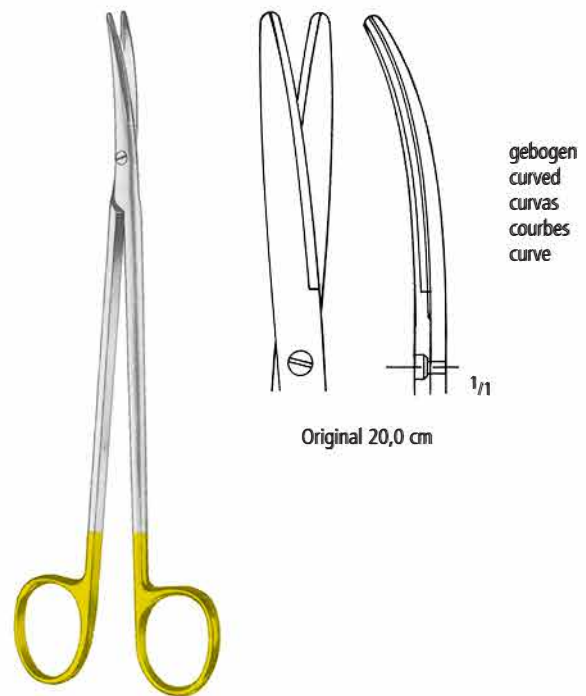

Original 20,0 cm

**METZENBAUM**

18,0 cm/7"

**AC 941/18\***

20,0 cm/8"

**AC 941/20\***

AA  
AB  
AC  
AD  
AE  
AF  
AK  
AL  
AO  
AP  
AR  
KA  
KL  
KM  
KO  
KU  
KYE  
X

Scheren mit Hartmetalleinlagen  
 Scissors with Tungsten Carbide Inserts  
 Tijeras con filos de carburo de tungsteno  
 Ciseaux avec plaquettes en carbure de tungstène  
 Forbici con taglio al carburo di tungsteno

nopa<sup>®</sup>  
**TUC**

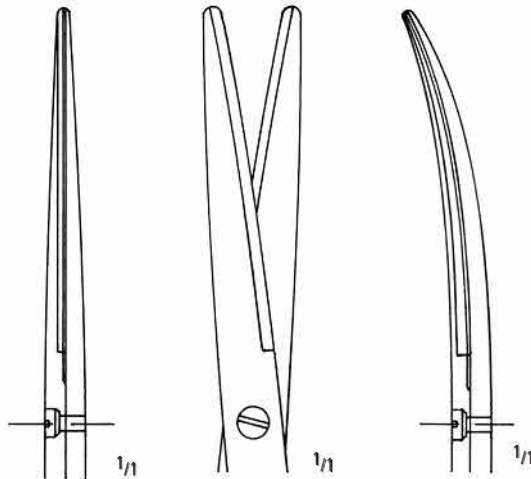

**LEXER**  
**AC 952/16**  
 16,0 cm/6<sup>1</sup>/<sub>4</sub>"



**LEXER**  
**AC 953/16**  
 16,0 cm/6<sup>1</sup>/<sub>4</sub>"

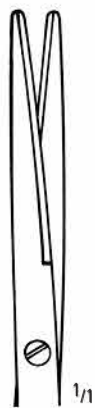
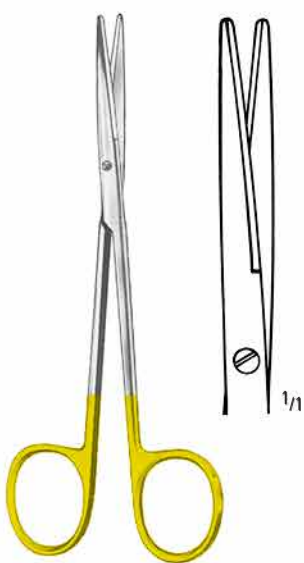

**AC 960/14\***  
 14,5 cm/5<sup>3</sup>/<sub>4</sub>"

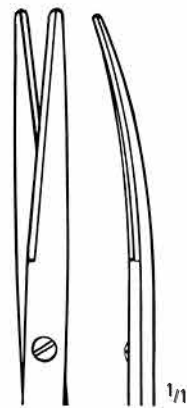
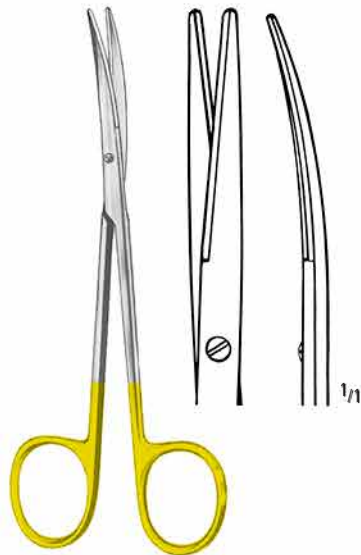

**AC 961/14\***  
 14,5 cm/5<sup>3</sup>/<sub>4</sub>"

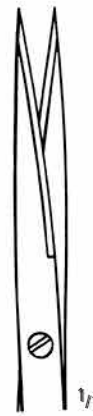
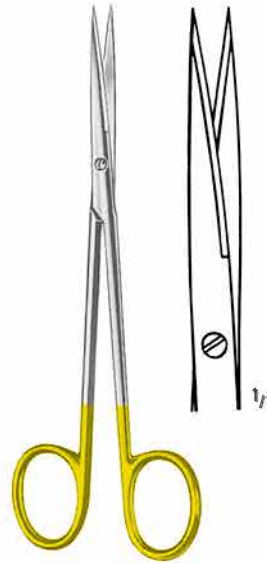

**AC 962/14**  
 14,5 cm/5<sup>3</sup>/<sub>4</sub>"

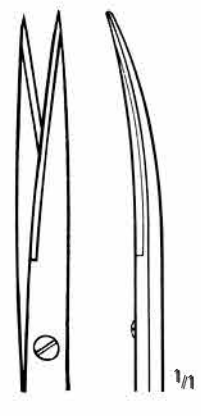
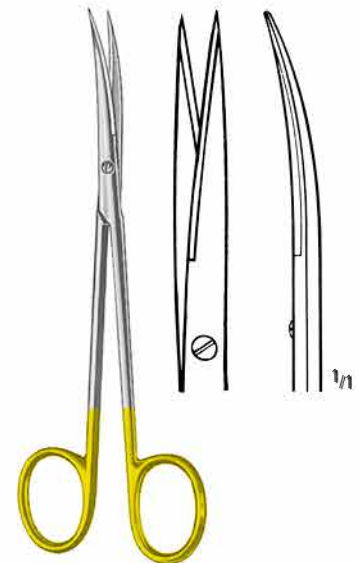

**AC 963/14**  
 14,5 cm/5<sup>3</sup>/<sub>4</sub>"

**METZENBAUM-DELICATE**

SCHEREN SCISSORS TIJERAS CISEAUX FORBICI

Scheren mit Hartmetalleinlagen  
 Scissors with Tungsten Carbide Inserts  
 Tijeras con filos de carburo de tungsteno  
 Ciseaux avec plaquettes en carbure de tungstène  
 Forbici con taglio al carburo di tungsteno

nopa<sup>®</sup>  
**TUC**

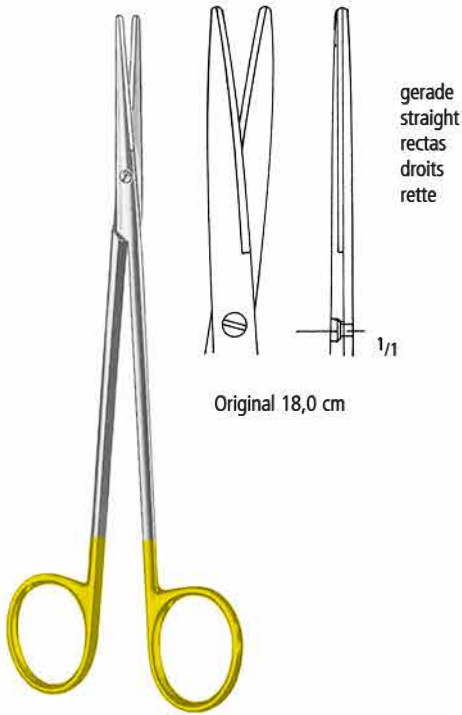

Original 18,0 cm

**METZENBAUM-DELICATE**  
 18,0 cm/7" **AC 970/18\***  
 20,0 cm/8" **AC 970/20\***

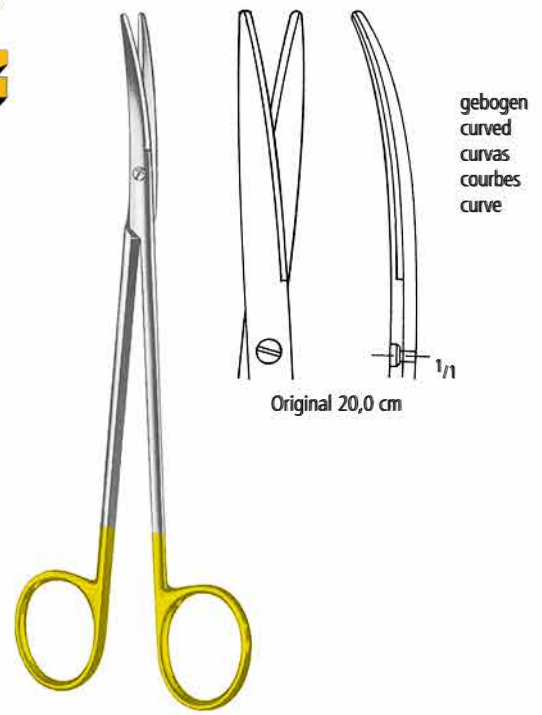

Original 20,0 cm

**METZENBAUM-DELICATE**  
 18,0 cm/7" **AC 971/18\***  
 20,0 cm/8" **AC 971/20\***

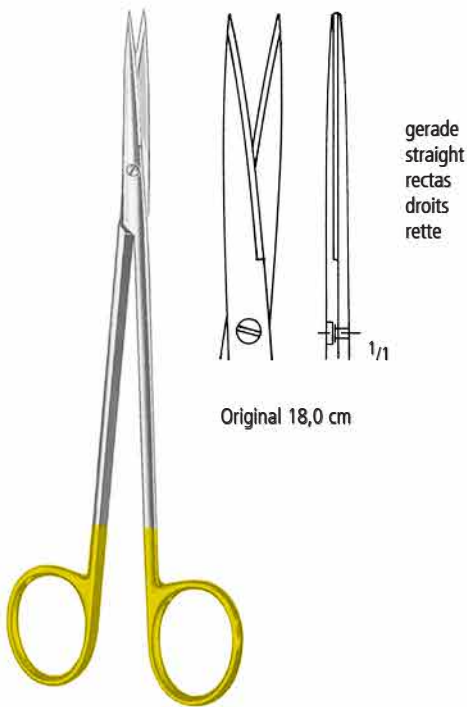

Original 18,0 cm

**METZENBAUM-DELICATE**  
 18,0 cm/7" **AC 972/18**  
 20,0 cm/8" **AC 972/20**

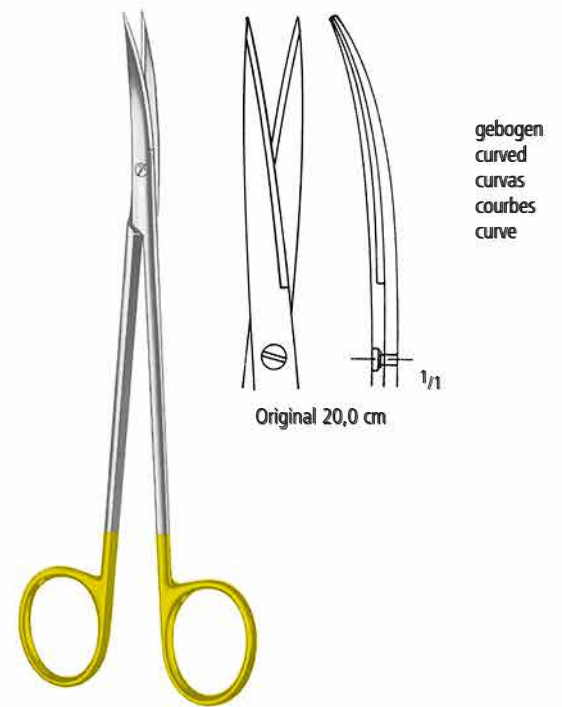

Original 20,0 cm

**METZENBAUM-DELICATE**  
 18,0 cm/7" **AC 973/18**  
 20,0 cm/8" **AC 973/20**

AA  
 AB  
**AC**  
 AD  
 AE  
 AF  
 AG  
 AH  
 AI  
 AJ  
 AK  
 AL  
 AM  
 AN  
 AO  
 AP  
 AQ  
 AR  
 AS  
 AT  
 AU  
 AV  
 AW  
 AX

Scheren mit Hartmetalleinlagen  
 Scissors with Tungsten Carbide Inserts  
 Tijeras con filos de carburo de tungsteno  
 Ciseaux avec plaquettes en carbure de tungstène  
 Forbici con taglio al carburo di tungsteno



Original 11,5 cm

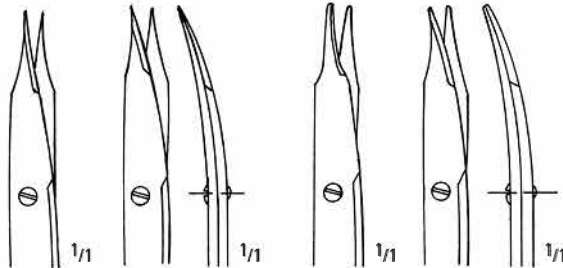

	spitz pointed agudas pointues acuta		stumpf blunt romas mousses smussa
gerade straight rectas droits rette	gebogen curved curvas courbes curve	gerade straight rectas droits rette	gebogen curved curvas courbes curve

**STEVENS**

10,5 cm/4<sup>1</sup>/<sub>4</sub>"  
 11,5 cm/4<sup>1</sup>/<sub>2</sub>"

**AC 974/10**    **AC 975/10**    **AC 976/10**    **AC 977/10**  
**AC 974/11\***    **AC 975/11\***    **AC 976/11**    **AC 977/11**

SCHEREN SCISSORS TIJERAS CISEAUX FORBICI

Scheren mit Hartmetalleinlagen  
 Scissors with Tungsten Carbide Inserts  
 Tijeras con filos de carburo de tungsteno  
 Ciseaux avec plaquettes en carbure de tungstène  
 Forbici con taglio al carburo di tungsteno

nopa®  
**TUC**

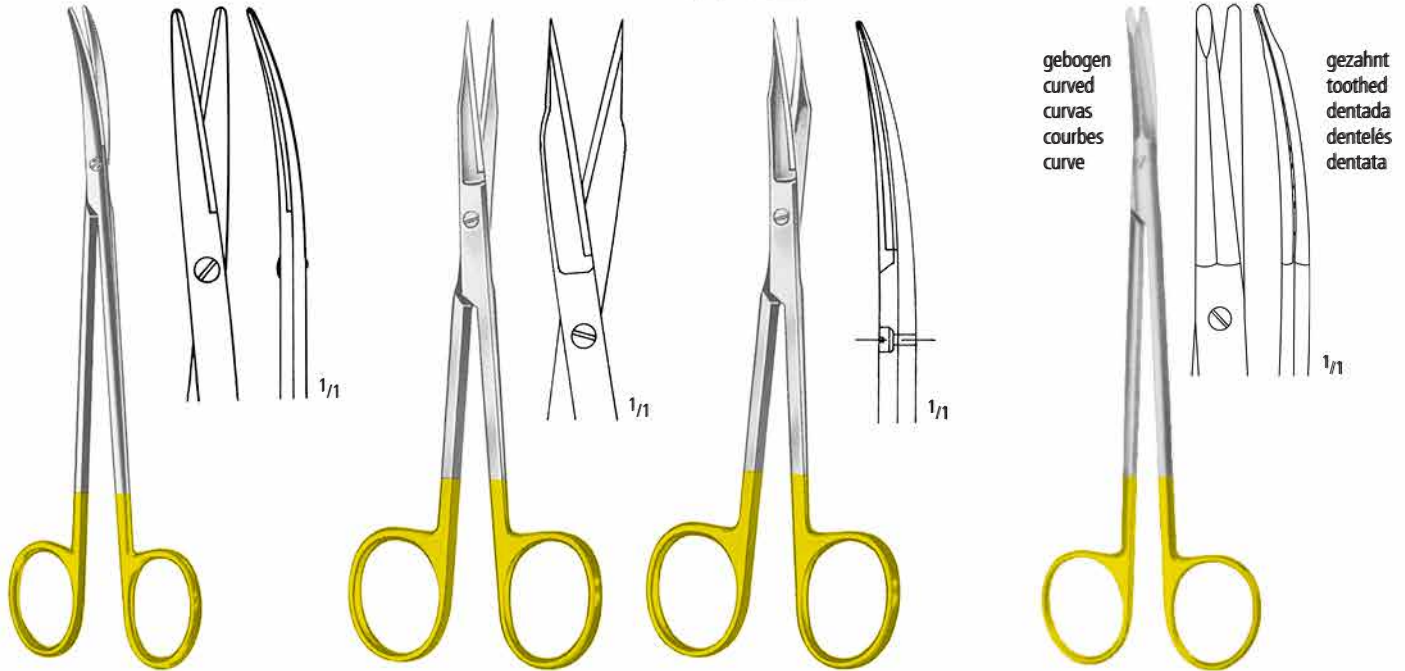

**TOENNIS-ADSON-DELICATE**  
**AC 977/17**  
 17,5 cm/7"

**GOLDMAN-FOX**  
**AC 980/13**  
 13,0 cm/5"

**AC 981/13**  
 13,0 cm/5"

**KAYE**  
**AC 983/15**  
 15,0 cm/6"

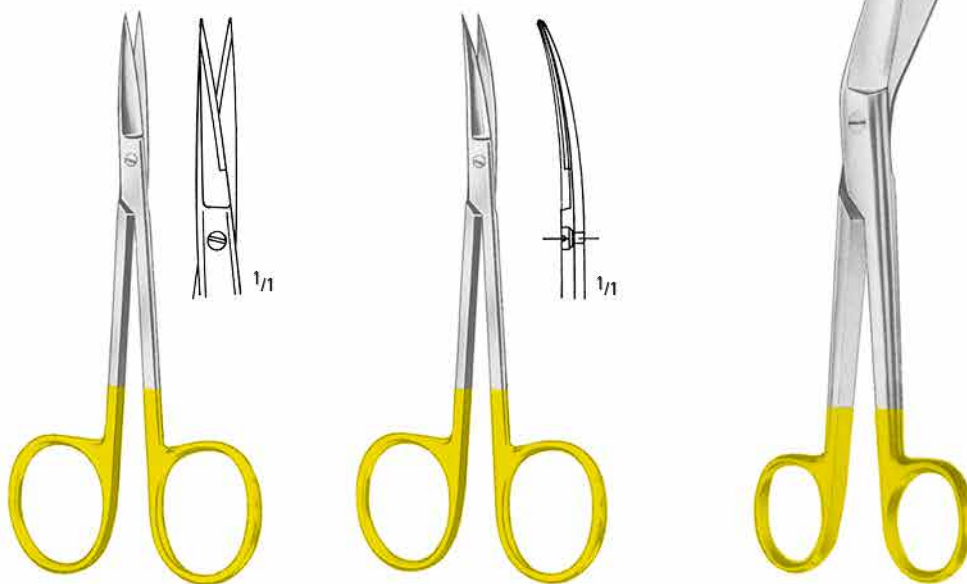

**AC 984/11\***  
 11,5 cm/4½"

**AC 985/11\***  
 11,5 cm/4½"

**LISTER**  
**AC 999/18**  
 18,0 cm/7"

gebogen  
 curved  
 curvas  
 courbes  
 curve

gezahnt  
 toothed  
 dentada  
 dentelés  
 dentata

AA  
 AB  
**AC**  
 AD  
 AE  
 AF  
 AG  
 AH  
 AI  
 AJ  
 AK  
 AL  
 AM  
 AN  
 AO  
 AP  
 AQ  
 AR  
 AS  
 AT  
 AU  
 AV  
 AW  
 AX





SKALPELLE  
SCALPELS  
BISTURIES  
BISTOURIS  
BISTURI

AD

nopa<sup>®</sup> instruments

Weitere Skalpelle finden Sie in unserem Katalog „Allgemeines Instrumentarium“ in Gruppe AD.

For further scalpels kindly refer to our catalogue „General Instruments“, section AD.

Para bisturías adicionales, por favor consulte nuestro catálogo de „Instrumental de uso general“, grupo AD.

Pour des bistouris supplémentaires, consultez notre catalogue „Instrumentation Generale“, section AD.

Per gli altri bisturi, consultare il nostro catalogo „Strumentazione Generale“, gruppo AD.



**AD** SKALPELLE SCALPELS BISTURIES BISTOURIS BISTURI

Skalpellgriffe  
 Scalpel Handles  
 Mangos de bisturías  
 Manches pour bistouris  
 Manici per bisturi



**AD 009/03**  
No. 3

**AD 010/03**  
No. 3

**AD 010/04**  
No. 4

**AD 010/05**  
No. 5K

**AD 025/07**  
No. 7

**AD 027/07**  
No. 7K

SKALPELLE SCALPELS BISTURIES BISTOURIS BISTURI

Skalpgriffe  
 Scalpel Handles  
 Mangos de bisturías  
 Manches pour bistouris  
 Manici per bisturi

AA  
 AB  
 AC  
 AD  
 AE  
 AF  
 AK  
 AL  
 AO  
 AP  
 AR  
 KA  
 KL  
 KM  
 KO  
 KU  
 KYE  
 X



**AD 030/16**



**AD 031/16**  
 No. 3



**AD 031/21**



**COLLIN**  
**AD 040/08**  
 No. 8

hohl  
 hollow  
 hueco  
 creux  
 vuoto



**COLLIN**  
**AD 042/09**  
 No. 9

Skalpelli  
Scalpel Handles  
Mangos de bisturías  
Manches pour bistouris  
Manici per bisturi

## MINI

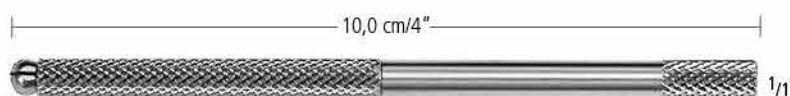

**AD 065/10**

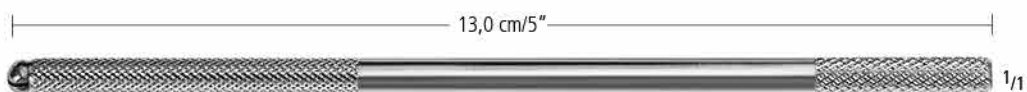

**AD 065/13**

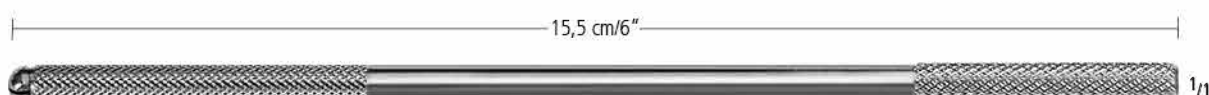

**AD 065/15**



SKALPELLE SCALPELS BISTURIES BISTOURIS BISTURI

Dermatome  
Dermatomes  
Dermatomos  
Dermatomos  
Dermatomi

AA

AB

AC

AD

AE

AF

AK

AL

AO

AP

AR

KA

KL

KM

KO

KU

KYE

X

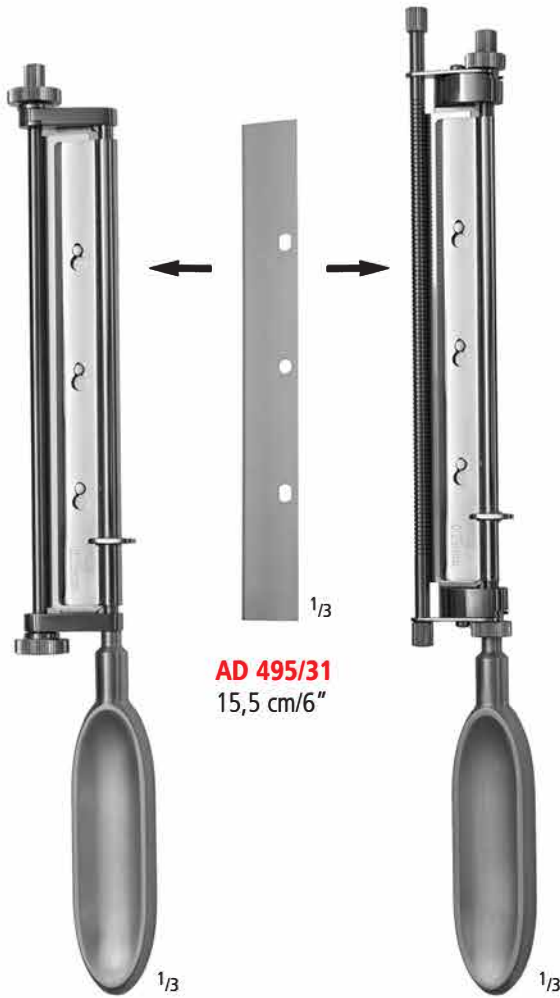

**AD 495/31**  
15,5 cm/6"

**WATSON**  
**AD 495/30**  
30,5 cm/12"  
0,1 - 2,0 mm

**HUMBY**  
**AD 495/32**  
32,0 cm/12<sup>3</sup>/<sub>4</sub>"  
0,1 - 1,2 mm



**SCHINK**  
**AD 500/00**  
30,0 cm/12"



**AD 510/01**

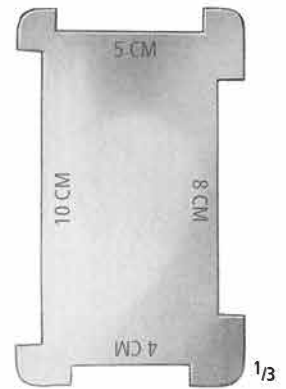

**AD 510/02**

**AD** SKALPELLE SCALPELS BISTURIES BISTOURIS BISTURI

Dermatome, Rasierklingen, Klängenbrecher  
 Dermatomes, Razor Blades, Blade Breakers  
 Dermatomo, Hojas de afeitár, Pinzas para romper hojas  
 Dermatomes, Lames de rasoir, Pincettes pour casser les lames  
 Dermatomi, Lamette da barba, Pinze per rompere la lamette

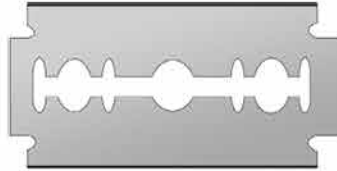

**AD 540/00**

RASIERKLINGEN, VERPACKUNGSEINHEIT 10 STCK  
 RAZOR BLADES, PACKING UNIT 10 PIECES  
 HOJAS DE AFEITAR, UNIDAD DE VENTA 10 PZ  
 LAMES DE RASOIR, UNITÉ À 10 PIÈCES  
 LAMETTE DA BARBA, UNITÀ DI VENDITA 10 PZ

**SILVER**  
**AD 515/19**  
 19,0 cm/7<sup>1</sup>/<sub>2</sub>



**TROUTMAN-CHRIS**  
**AD 550/09**  
 Ø 5,5 mm  
 9,0 cm/3<sup>1</sup>/<sub>2</sub>"



**TROUTMAN-CHRIS**  
**AD 551/09**  
 Ø 5,5 mm  
 9,0 cm/3<sup>1</sup>/<sub>2</sub>"



**AD 552/11**  
 11,0 cm/4<sup>1</sup>/<sub>3</sub>"



**CASTROVIEJO**  
**AD 554/13**  
 Ø 8 mm  
 13,0 cm/5"

NAHT  
SUTURE  
SUTURA  
SUTURE  
SUTURA

AE

nopa<sup>®</sup> instruments

Weitere Naht-Instrumente finden Sie in unserem Katalog „Allgemeines Instrumentarium“ in Gruppe AE.

For further suture instruments kindly refer to our catalogue „General Instruments“, section AE.

Para instrumentos de sutura adicionales, por favor consulte nuestro catálogo de „Instrumental de uso general“, grupo AE.

Pour des instruments de suture supplémentaires, consultez notre catalogue „Instrumentation Generale“, section AE.

Per gli altri accessori di sutura, consultare il nostro catalogo „Strumentazione Generale“, gruppo AE.



**AE** NAHT SUTURE SUTURA SUTURE SUTURA

Nadelhalter  
 Needle Holders  
 Porta-agujas  
 Porte-aiguilles  
 Portaghi



**BOYNTON**  
**AE 036/12**  
 12,0 cm/4<sup>3</sup>/<sub>4</sub>"

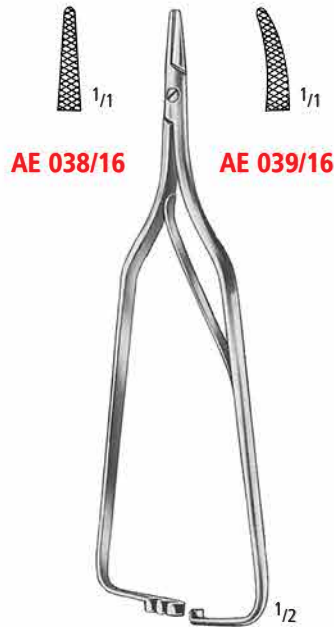

**AE 038/16**      **AE 039/16**

**ARRUGA**  
 16,0 cm/6<sup>1</sup>/<sub>4</sub>"

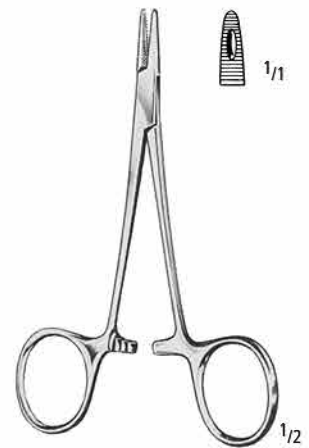

**DERF**  
**AE 050/12**  
 12,0 cm/4<sup>3</sup>/<sub>4</sub>"

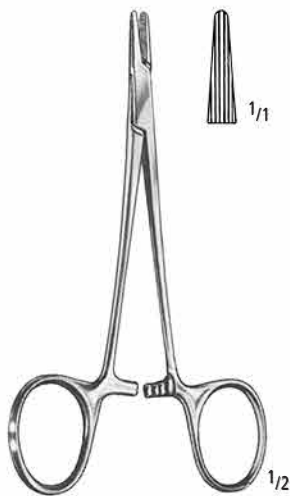

**DERF-CONVERSE**  
**AE 052/12**  
 12,5 cm/5"

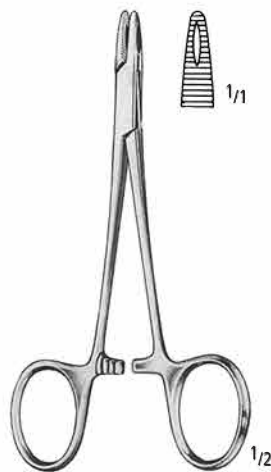

**COLLIER**  
**AE 056/12**  
 12,5 cm/5"

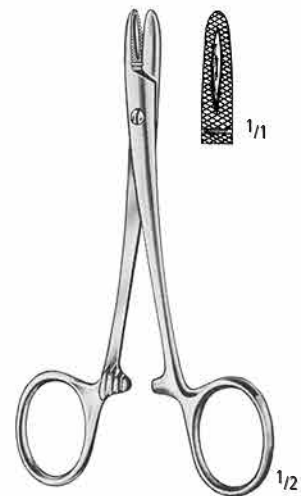

**DOYEN**  
**AE 058/12**  
 12,5 cm/5"

NAHT SUTURE SUTURA SUTURE SUTURA

Nadelhalter  
 Needle Holders  
 Porta-agujas  
 Porte-aiguilles  
 Portaghi

AA  
 AB  
 AC  
 AD  
 AE  
 AF  
 AK  
 AL  
 AO  
 AP  
 AR  
 KA  
 KL  
 KM  
 KO  
 KU  
 KYE  
 X

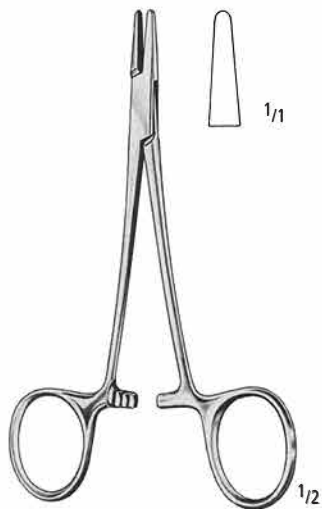

**WEBSTER**  
**AE 060/13**  
 13,0cm/5"

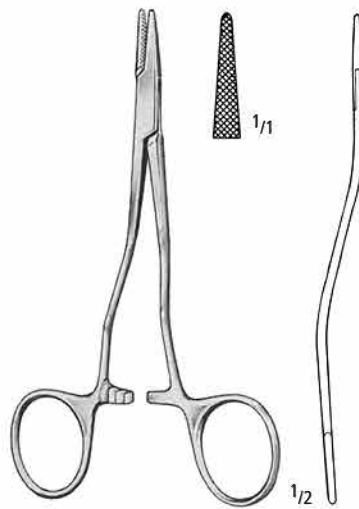

**KILNER**  
**AE 063/13**  
 13,0 cm/5"

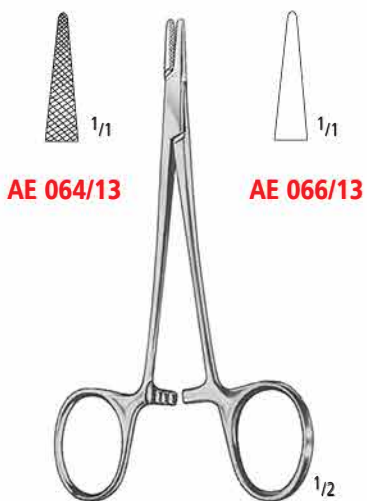

**HALSEY**  
 13,0cm/5"

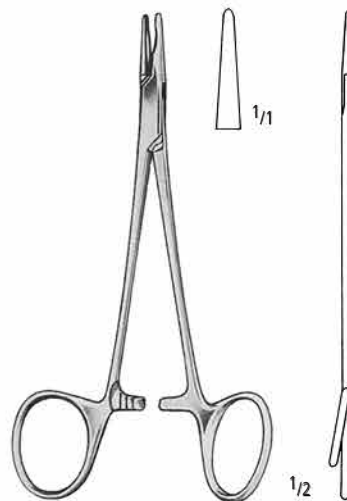

**NEIVERT**  
**AE 068/13**  
 13,0cm/5"



**AE** NAHT SUTURE SUTURA SUTURE SUTURA

Nadelhalter  
 Needle Holders  
 Porta-agujas  
 Porte-aiguilles  
 Portaghi



**CRILE-WOOD**

15,0 cm/6" **AE 070/15**  
 18,0 cm/7" **AE 070/18**

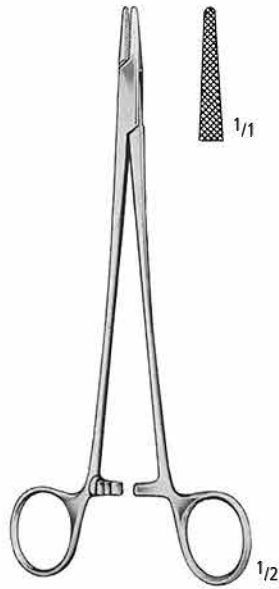

**BABY-CRILE-WOOD**

**AE 072/15**  
 15,0 cm/6"



**CARROLL**

**AE 074/15**  
 15,0 cm/6"



**CRILE-MURRAY**

**AE 076/15**  
 15,0 cm/6"

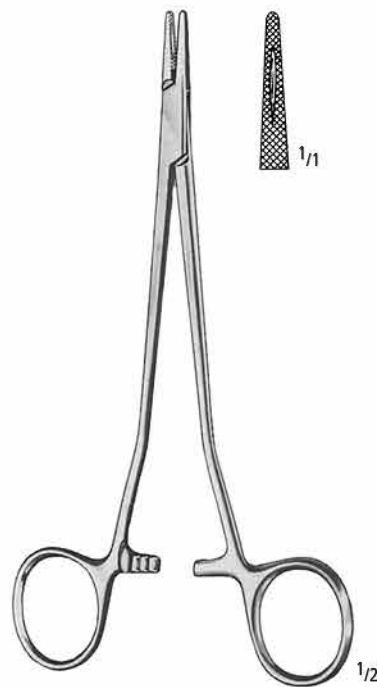

**SAROT**

**AE 080/18**  
 18,0 cm/7"

NAHT SUTURE SUTURA SUTURE SUTURA

Nadelhalter  
Needle Holders  
Porta-agujas  
Porte-aiguilles  
Portaghi

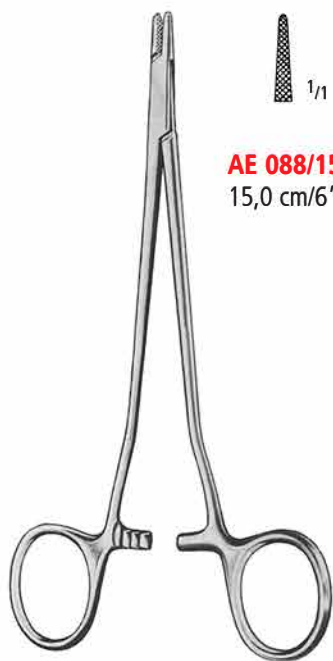

**AE 088/15**  
15,0 cm/6"



**AE 088/17**  
17,0 cm/6¾"

1/2

**SENNING**  
(Schwed. Modell)

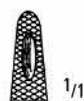
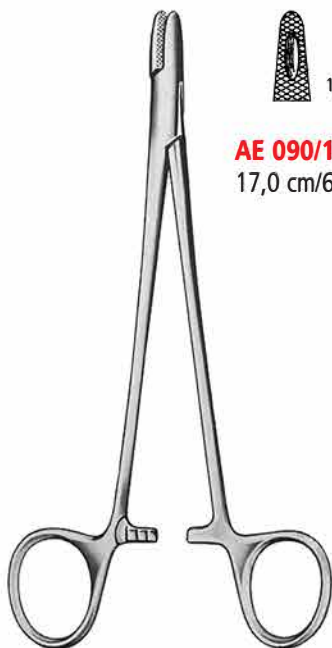

**AE 090/17**  
17,0 cm/6¾"

1/2

**M.G.H.**  
(Mass.-General-Hospital)



**ADSON**  
**AE 094/18**  
18,0 cm/7"

1/2



**AE 100/14**  
14,0 cm/5½"



**AE 100/16**  
16,0 cm/6¼"



**AE 100/18**  
18,0 cm/7"



**AE 100/20**  
20,0 cm/8"

1/2

**MAYO-HEGAR**

**MAYO-HEGAR-DELICATE**



**AE 110/16**  
16,0 cm/6¼"



**AE 110/18**  
18,0 cm/7"



**AE 110/20**  
20,0 cm/8"

1/1

1/1

1/1



**BAUMGARTNER**  
**AE 112/14**  
14,0 cm/5½"

1/2

AA  
AB  
AC  
AD  
AE  
AF  
AK  
AL  
AO  
AP  
AR  
KA  
KL  
KM  
KO  
KU  
KYE  
X

**AE** NAHT SUTURE SUTURA SUTURE SUTURA

Nadelhalter  
Needle Holders  
Porta-agujas  
Porte-aiguilles  
Portaghi

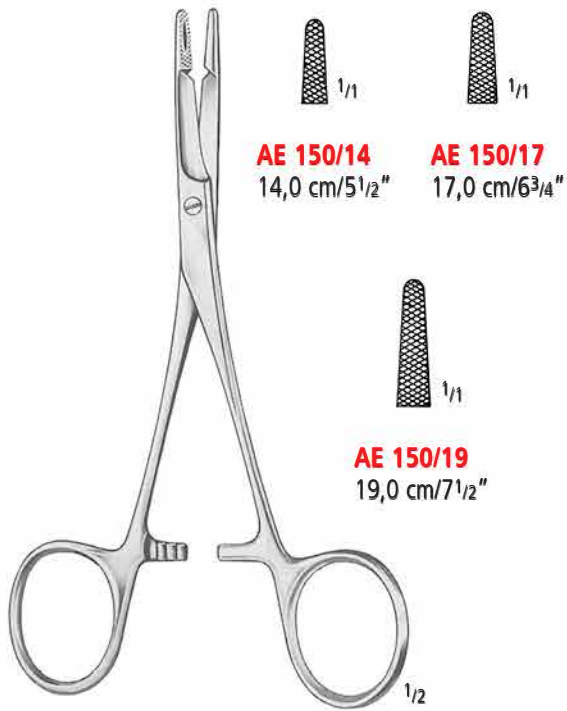

**AE 150/14**  
14,0 cm/5½"

**AE 150/17**  
17,0 cm/6¾"

**AE 150/19**  
19,0 cm/7½"

**OLSEN-HEGAR**

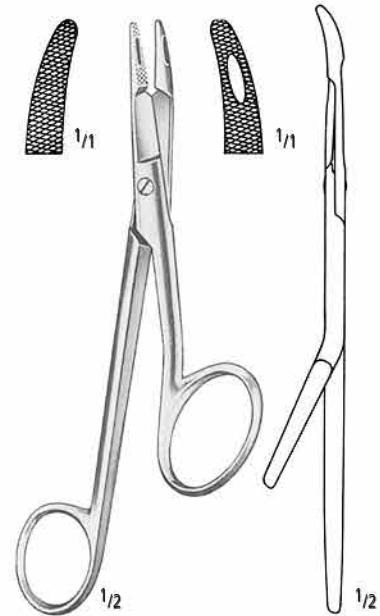

**GILLIES**  
**AE 155/16**  
16,0 cm/6¼"

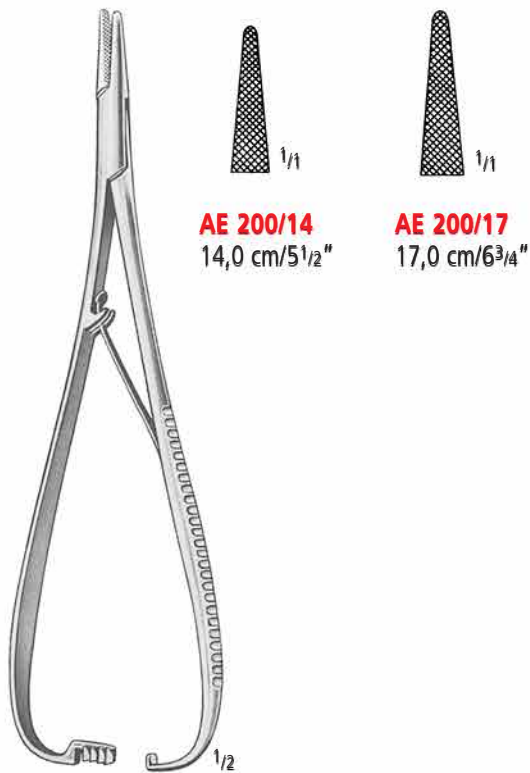

**AE 200/14**  
14,0 cm/5½"

**AE 200/17**  
17,0 cm/6¾"

**MATHIEU**

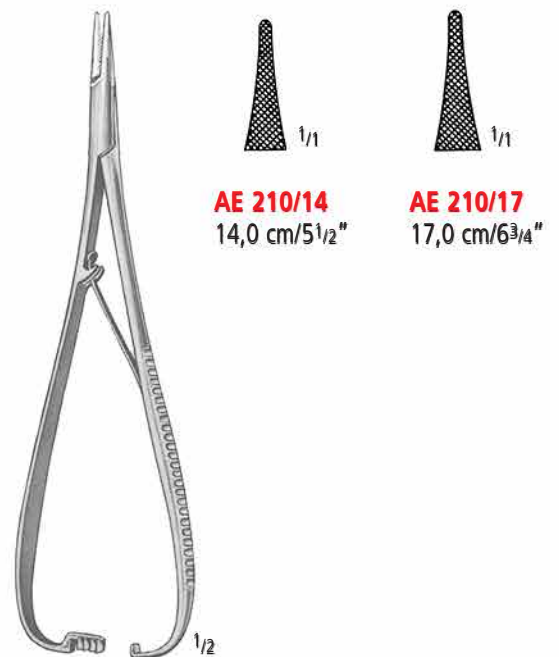

**AE 210/14**  
14,0 cm/5½"

**AE 210/17**  
17,0 cm/6¾"

**MATHIEU-DELICATE**

NAHT SUTURE SUTURA SUTURE SUTURA

Nadelhalter  
Needle Holders  
Porta-agujas  
Porte-aiguilles  
Portaghi



**CRILE**  
**AE 224/15**  
15,0 cm/6"



**TOENNIS**  
**AE 226/18**  
18,0 cm/7"



**LANGENBECK**



**AE 228/18**  
18,0 cm/7"



**AE 228/20**  
20,0 cm/8"

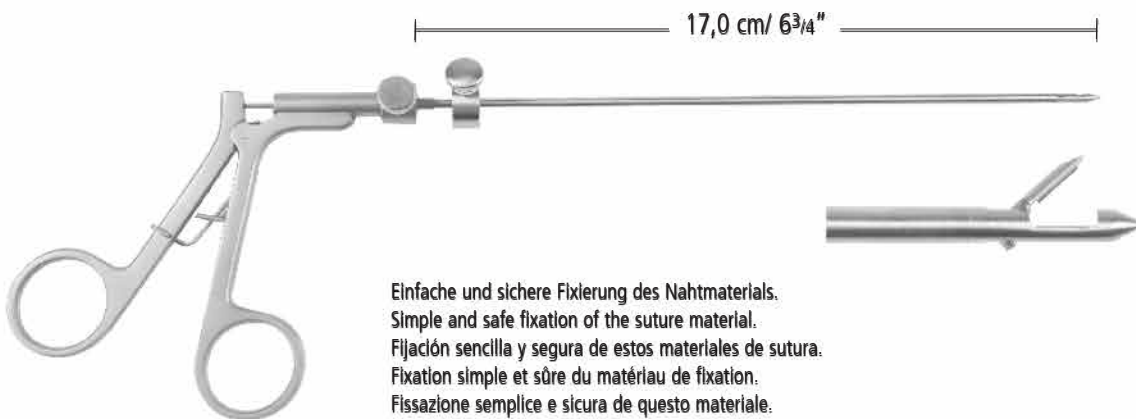

Suture Instrument  
**AE 310/17**  
Ø 3,0 mm

Einfache und sichere Fixierung des Nahtmaterials.  
Simple and safe fixation of the suture material.  
Fijación sencilla y segura de estos materiales de sutura.  
Fixation simple et sûre du matériau de fixation.  
Fissazione semplice e sicura de questo materiale.

AA  
AB  
AC  
AD  
AE  
AF  
AK  
AL  
AO  
AP  
AR  
KA  
KL  
KM  
KO  
KU  
KYE  
X

**AE** NAHT SUTURE SUTURA SUTURE SUTURA

Nadelhalter mit Hartmetalleinsätzen  
 Needle Holders with Tungsten Carbide Inserts  
 Porta-agujas con bocas de carburo de Tungsteno  
 Porte-aiguilles à mors en carbure de tungstène  
 Portaghi con placche di carburo di tungsteno



**MAYO-HEGAR**

**AE 400/14**  
14,0 cm/5 1/2"

**AE 400/16**  
16,0 cm/6 1/4"

**AE 400/18**  
18,0 cm/7"

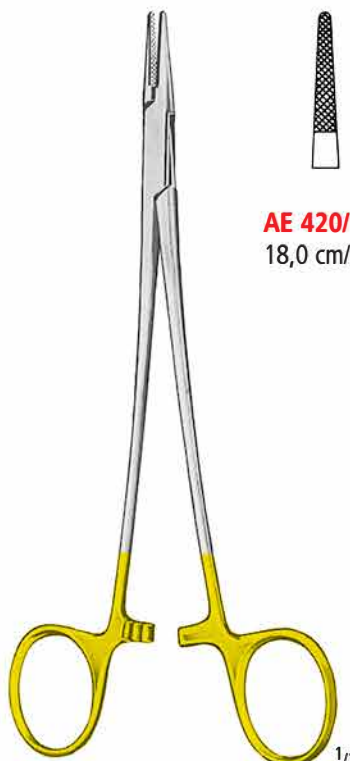

**AE 400/20**  
20,0 cm/8"



**DE BAKEY  
(MAYO-HEGAR-DELICATE)**

**AE 420/18**  
18,0 cm/7"

**AE 420/20**  
20,0 cm/8"

**RYDER/FRENCH-EYE**

**AE 430/13**  
13,0 cm/5"

**AE 430/15**  
15,0 cm/6"

**AE 430/18**  
18,0 cm/7"

**MICRO RYDER**

**AE 434/13**  
13,0 cm/5"

**AE 434/15**  
15,0 cm/6"

**AE 434/18**  
18,0 cm/7"



NAHT SUTURE SUTURA SUTURE SUTURA

Nadelhalter mit Hartmetalleinsätzen  
 Needle Holders with Tungsten Carbide Inserts  
 Porta-agujas con bocas de carburo de Tungsteno  
 Porte-aiguilles à mors en carbure de tungstène  
 Portaghi con placche di carburo di tungsteno

AA  
AB  
AC  
AD  
AE  
AF  
AK  
AL  
AO  
AP  
AR  
KA  
KL  
KM  
KO  
KU  
KYE  
X

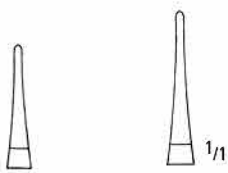

**AE 436/14** 14,0 cm/5<sup>1</sup>/<sub>2</sub>"  
**AE 436/18** 18,0 cm/7"

**EUFRATE PASQUÉ**

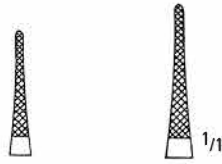

**AE 438/14** 14,0 cm/5<sup>1</sup>/<sub>2</sub>"  
**AE 438/18** 18,0 cm/7"

**MICROVASCULAR**

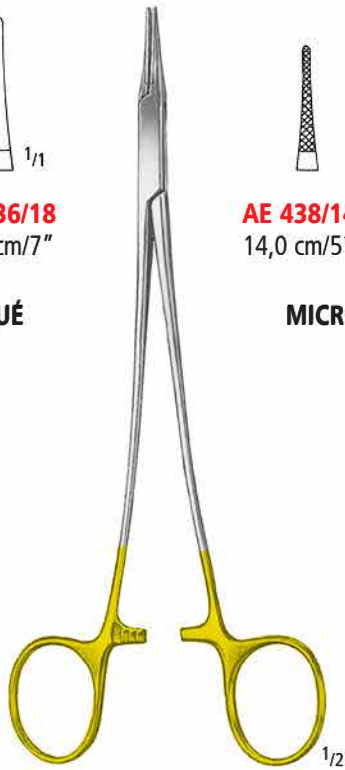

extrem fein extremely delicate muy fino très fin molto fino

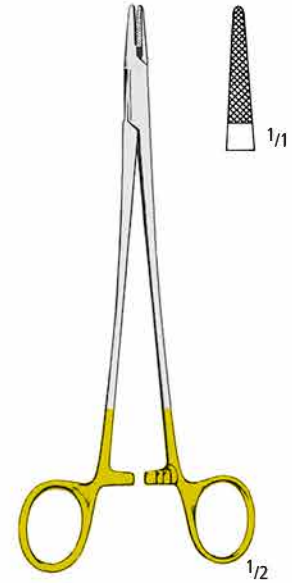

**CARROLL**  
**AE 440/15**  
 15,0 cm/6"

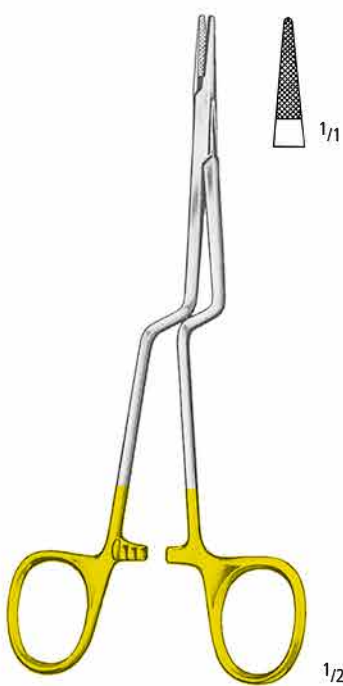

**JACOBSON**  
**AE 444/18**  
 18,0 cm/7"

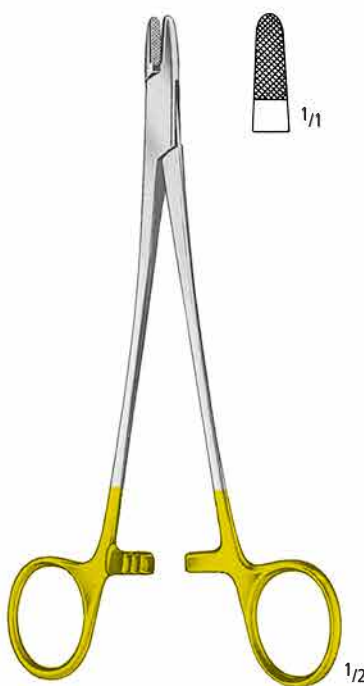

**NEW ORLEANS**  
**AE 446/18**  
 18,0 cm/7"

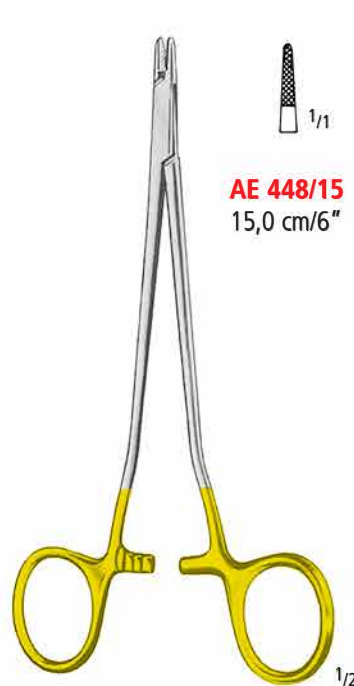

**SENNING**  
 (SWEDISH PATTERN)



**AE** NAHT SUTURE SUTURA SUTURE SUTURA

Nadelhalter mit Hartmetalleinsätzen  
 Needle Holders with Tungsten Carbide Inserts  
 Porta-agujas con bocas de carburo de Tungsteno  
 Porte-aiguilles à mors en carbure de tungstène  
 Portaghi con placche di carburo di tungsteno



**DERF**  
**AE 450/12**  
 12,5 cm/5"

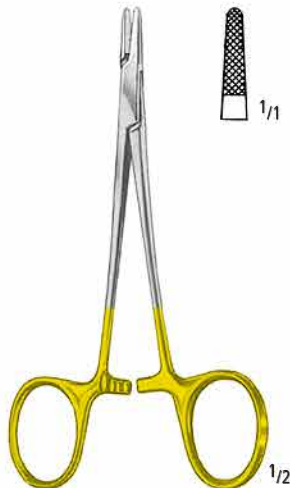

**CONVERSE**  
**AE 452/12**  
 12,5 cm/5"

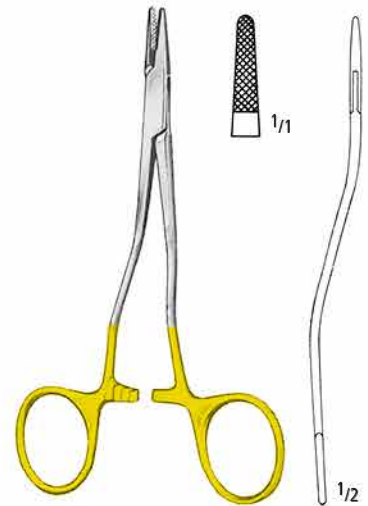

**KILNER**  
**AE 455/13**  
 13,5 cm/5¼"

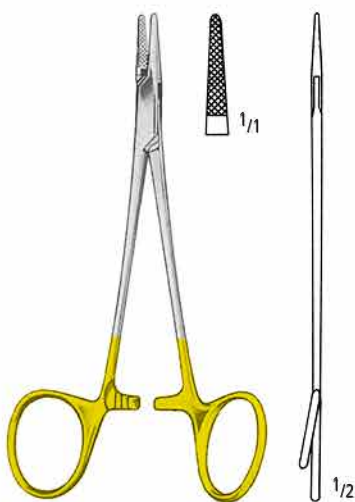

**NEIVERT**  
**AE 456/13**  
 13,0 cm/5"

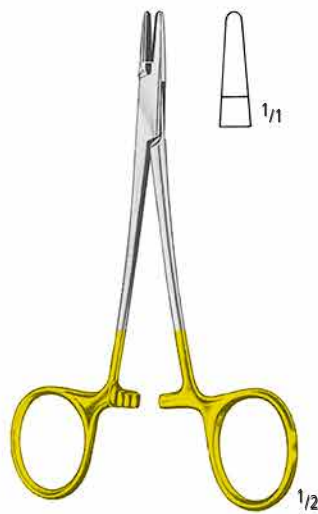

**WEBSTER**  
**AE 460/13**  
 13,0 cm/5"

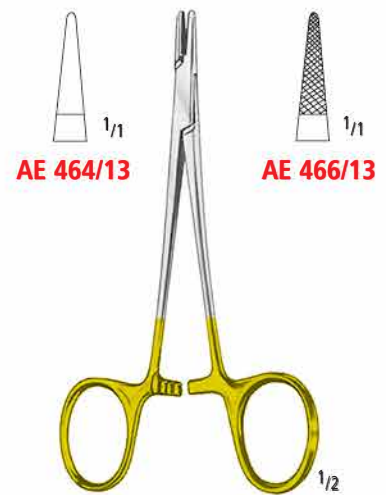

**HALSEY**  
 13,0 cm/5"

NAHT SUTURE SUTURA SUTURE SUTURA

Nadelhalter mit Hartmetalleinsätzen  
 Needle Holders with Tungsten Carbide Inserts  
 Porta-agujas con bocas de carburo de Tungsteno  
 Porte-aiguilles à mors en carbure de tungstène  
 Portaghi con placche di carburo di tungsteno

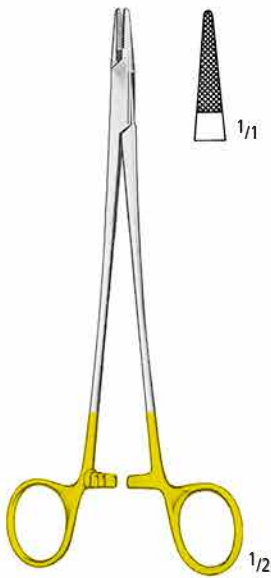

**BABY-CRILE-WOOD**  
**AE 468/15**  
 15,0 cm/6"

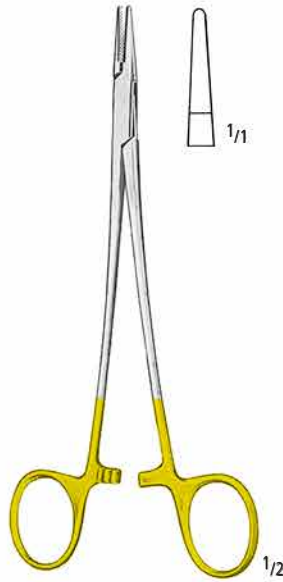

**CRILE-WOOD**  
**AE 469/15**  
 15,0 cm/6"

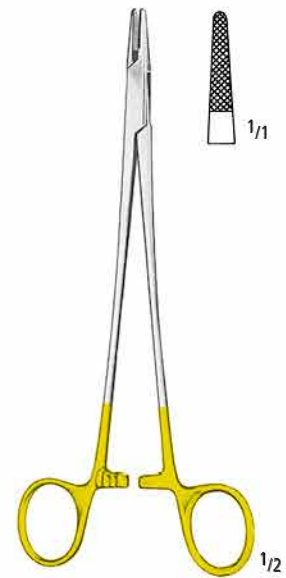

**CRILE-WOOD**  
**AE 470/15**  
 15,0 cm/6"

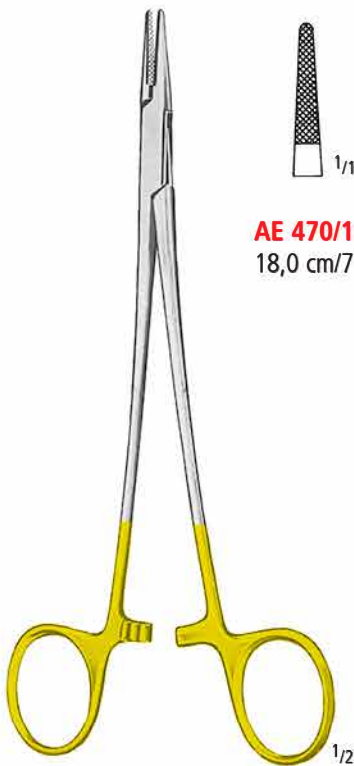

**CRILE-WOOD**

**AE 470/18**  
 18,0 cm/7"

**AE 470/20**  
 20,0 cm/8"



**AE 471/18**  
 18,0 cm/7"



**SAROT**

**AE 480/18**  
 18,0 cm/7"

AA  
 AB  
 AC  
 AD  
**AE**  
 AF  
 AK  
 AL  
 AO  
 AP  
 AR  
 KA  
 KL  
 KM  
 KO  
 KU  
 KYE  
 X

Nadelhalter diamantstaubbeschichtet  
Needle Holders diamond dust coated  
Porta-agujas polvo de diamante recubierto  
Porte-aiguilles enduit de poussière de diamant  
Portaghi polvere diamantata

## nopa® DIAMOND



15,0 cm/6"  
18,0 cm/7"  
23,0 cm/9"

**KS 084/15**  
**KS 084/18**  
**KS 084/23**

NAHT SUTURE SUTURA SUTURE SUTURA

Nadelhalter mit Hartmetalleinsätzen  
 Needle Holders with Tungsten Carbide Inserts  
 Porta-agujas con bocas de carburo de Tungsteno  
 Porte-aiguilles à mors en carbure de tungstène  
 Portaghi con placche di carburo di tungsteno

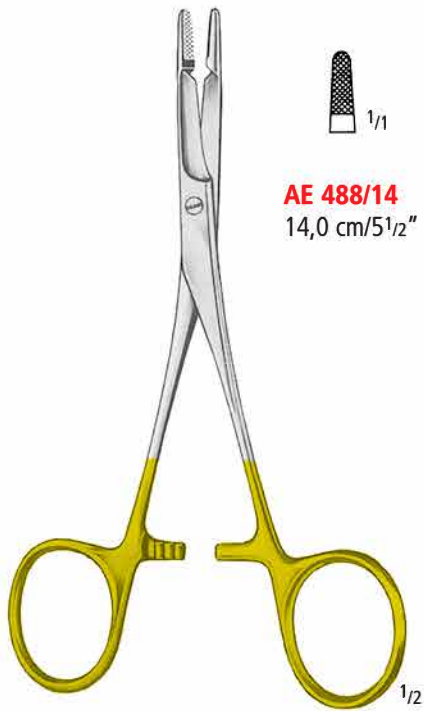

**AE 488/14**  
 14,0 cm/5<sup>1</sup>/<sub>2</sub>"

**AE 488/17**  
 17,0 cm/6<sup>3</sup>/<sub>4</sub>"

**AE 488/19**  
 19,0 cm/7<sup>1</sup>/<sub>2</sub>"

**OLSEN-HEGAR**

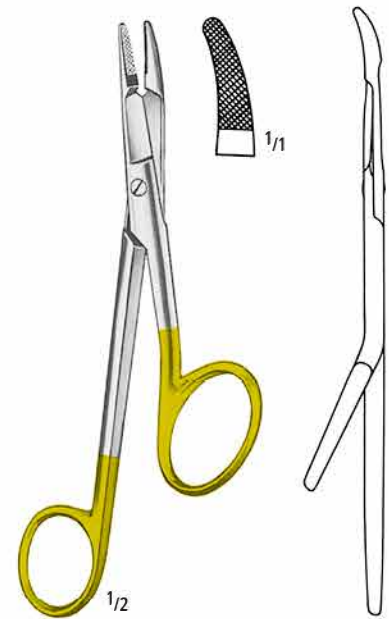

**GILLIES**  
**AE 490/16**  
 16,0 cm/6<sup>1</sup>/<sub>4</sub>"

**MATHIEU**

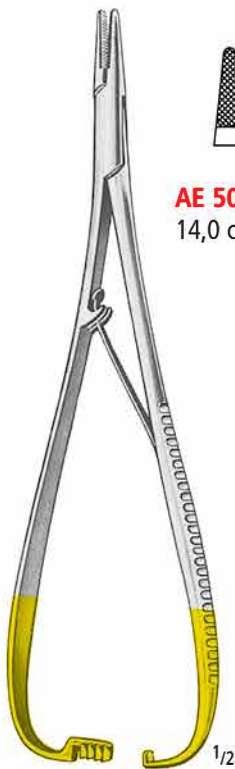

**AE 500/14**  
 14,0 cm/5<sup>1</sup>/<sub>2</sub>"

**AE 500/17**  
 17,0 cm/6<sup>3</sup>/<sub>4</sub>"

**MATHIEU**



**AE 501/14**  
 14,0 cm/5<sup>1</sup>/<sub>2</sub>"

**MATHIEU**

AA  
 AB  
 AC  
 AD  
**AE**  
 AF  
 AK  
 AL  
 AO  
 AP  
 AR  
 KA  
 KL  
 KM  
 KO  
 KU  
 KYE  
 X



**AE** NAHT SUTURE SUTURA SUTURE SUTURA

Nadelhalter mit Hartmetalleinsätzen  
 Needle Holders with Tungsten Carbide Inserts  
 Porta-agujas con bocas de carburo de Tungsteno  
 Porte-aiguilles à mors en carbure de tungstène  
 Portaghi con placche di carburo di tungsteno



**MATHIEU-DELICATE**



**AE 504/14**  
14,0 cm/5 1/2"



**AE 504/17**  
17,0 cm/6 3/4"



**AE 504/20**  
20,0 cm/8"

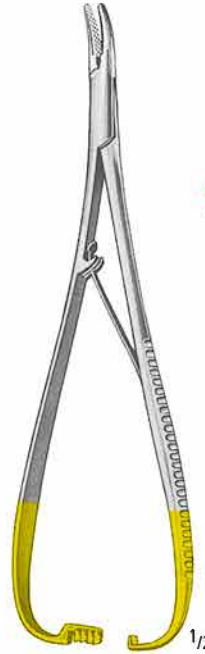

**METZENBAUM**



**AE 507/17**  
17,0 cm/6 3/4"



**AE 507/19**  
19,5 cm/7 1/2"

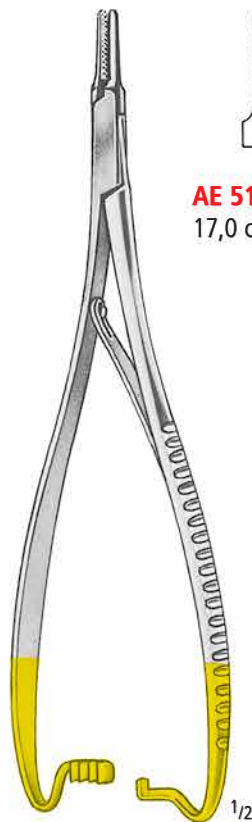

**MATHIEU-RYDER**



**AE 510/17**  
17,0 cm/6 3/4"

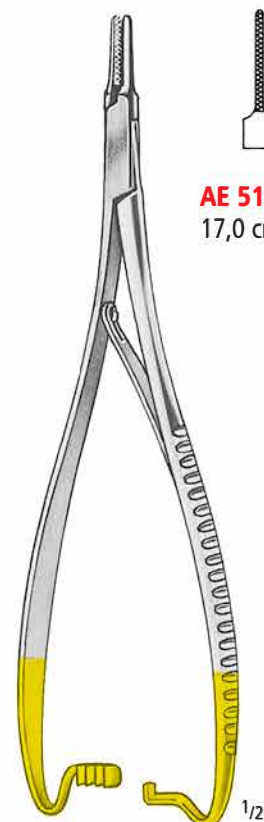

**MATHIEU-RYDER VASCULAR**



**AE 512/17**  
17,0 cm/6 3/4"

NAHT SUTURE SUTURA SUTURE SUTURA

Nadelhalter mit Hartmetalleinsätzen  
 Needle Holders with Tungsten Carbide Inserts  
 Porta-agujas con bocas de carburo de Tungsteno  
 Porte-aiguilles à mors en carbure de tungstène  
 Portaghi con placche di carburo di tungsteno



**BOYNTON**  
 12,0 cm/4<sup>3</sup>/<sub>4</sub>"



**ARRUGA**  
 16,0 cm/6<sup>1</sup>/<sub>4</sub>"



**TOENNIS**  
**AE 522/18**  
 18,0 cm/7"

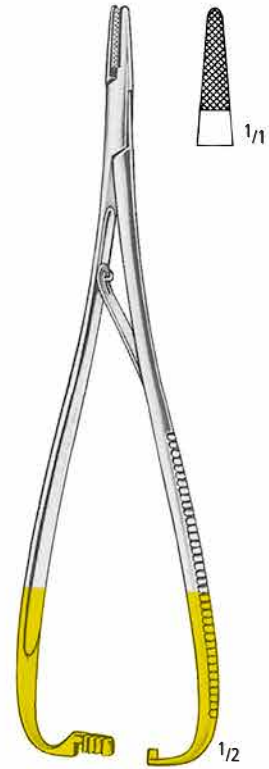

**LICHTENBERG**  
**AE 524/20**  
 20,0 cm/8"

AA  
 AB  
 AC  
 AD  
**AE**  
 AF  
 AK  
 AL  
 AO  
 AP  
 AR  
 KA  
 KL  
 KM  
 KO  
 KU  
 KYE  
 X

**AE** NAHT SUTURE SUTURA SUTURE SUTURA

Nadelhalter, Drahtzangen mit Hartmetalleinsätzen  
 Needle Holders, Wire Twisting Forceps with Tungsten Carbide Inserts  
 Porta-agujas, Pinzas para torcer hilos con bocas de carburo de Tungsteno  
 Porte-aiguilles, Pinces à torsader le fil à mors en carbure de tungstène  
 Portaghi, Pinze per ritorcere fili con placche di carburo di tungsteno



**AE 542/18**  
18,0 cm/7"

**LANGENBECK-DELICATE**



**AE 544/18**  
18,0 cm/7"



**AE 544/20**  
20,0 cm/8"

**LANGENBECK-RYDER**



**AE 550/13**  
13,0 cm/5"

**STERNUM**



**AE 550/18**  
18,0 cm/7"



**AE 551/01**  
15,0 cm/6"

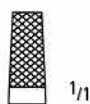

**AE 551/02**  
18,0 cm/7"



**AE 556/01**  
16,5 cm/6 1/2"



**AE 556/02**  
15,0 cm/6"

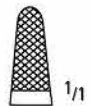

**AE 556/03**  
15,0 cm/6"

**CORWIN**

NAHT SUTURE SUTURA SUTURE SUTURA

Mikro-Nadelhalter mit Hartmetalleinsätzen  
 Micro-Needle Holders with Tungsten Carbide Inserts  
 Micro-Porta-agujas con bocas de carburo de Tungsteno  
 Micro-Porte-aiguilles à mors en carbure de tungstène  
 Micro-Portaghi con placche di carburo di tungsteno

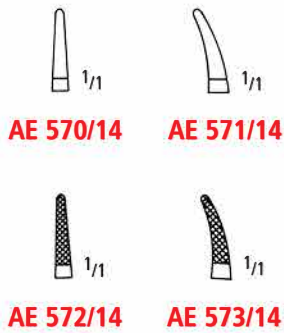

**CASTROVIEJO**  
 14,0 cm/5½"

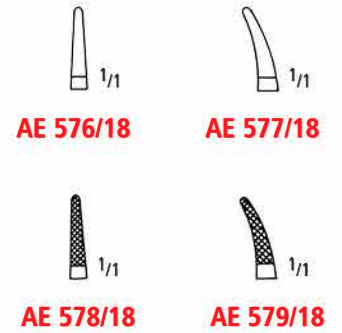

18,0 cm/7"

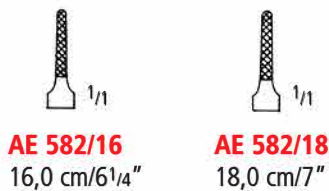

**DIETHRICH**

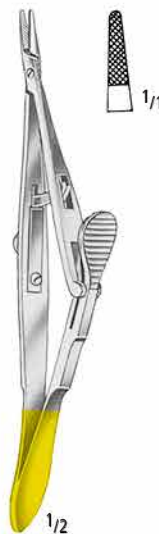

**KALT**  
**AE 584/14**  
 13,5 cm/5¼"



**CASTROVIEJO**  
**AE 586/13**  
 13,0 cm/5"

AA  
 AB  
 AC  
 AD  
**AE**  
 AF  
 AG  
 AH  
 AI  
 AJ  
 AK  
 AL  
 AM  
 AN  
 AO  
 AP  
 AQ  
 AR  
 AS  
 AT  
 AU  
 AV  
 AW  
 AX

Mikro-Nadelhalter mit Rundgriff, diamantstaubbeschichtet  
 Micro-Needle Holders with Pen-Type Handle, diamond dust coated  
 Micro-Porta-agujas con mango redondo, polvo de diamante recubierto  
 Micro-Porte-aiguilles à manches rondes, enduit de poussière de diamant  
 Micro-Portaghi con manici rotondi, polvere diamantata

nopa® DIAMOND



**KS 080/14**  
14,0 cm/5½"



**KS 080/18**  
18,0 cm/7"



**KS 081/14**  
14,0 cm/5½"



**KS 081/18**  
18,0 cm/7"



NAHT SUTURE SUTURA SUTURE SUTURA

Mikro-Nadelhalter mit Rundgriff, diamantstaubbeschichtet  
 Micro-Needle Holders with Pen-Type Handle, diamond dust coated  
 Micro-Porta-agujas con mango redondo, polvo de diamante recubierto  
 Micro-Porte-aiguilles à manches rondes, enduit de poussière de diamant  
 Micro-Portaghi con manici rotondi, polvere diamantata

nopa® DIAMOND

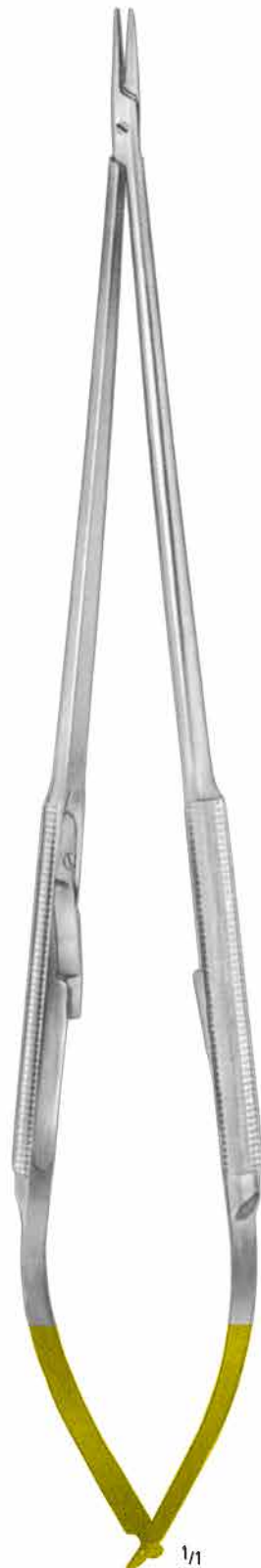

KS 082/21



KS 083/21

1/1

21,0 cm/8 1/4"

AA  
AB  
AC  
AD  
AE  
AF  
AK  
AL  
AO  
AP  
AR  
KA  
KL  
KM  
KO  
KU  
KYE  
X

Mikro-Nadelhalter mit Rundgriff  
 Micro-Needle Holders with Pen-Type Handle  
 Micro-Porta-agujas con mango redondo  
 Micro-Porte-aiguilles à manches rondes  
 Micro-Portaghi con manici rotondi



**AE 610/15**



**AE 611/15**

**REILL**  
 15,0 cm/6"



**AE 612/15**



**AE 613/15**

**REILL**  
 15,0 cm/6"

NAHT SUTURE SUTURA SUTURE SUTURA

Mikro-Nadelhalter mit Rundgriff  
 Micro-Needle Holders with Pen-Type Handle  
 Micro-Porta-agujas con mango redondo  
 Micro-Porte-aiguilles à manches rondes  
 Micro-Portaghi con manici rotondi



**AE 621/14**  
 14,0 cm/5 1/2"



**AE 623/14**  
 14,0 cm/5 1/2"

...für Rechtshänder  
 ...for right handed surgeons  
 ...para diestros  
 ...pour des droitiers  
 ...per destrimani

Maulteil konkav/konvex  
 Jaws concave/convex  
 Bocas concavas/convexas  
 Mors concave/convexe  
 Morso concavo/convesso



**AE 625/14**  
 14,0 cm/5 1/2"

...für Linkshänder  
 ...for left handed surgeons  
 ...para zurdos  
 ...pour gaucher  
 ...per mancini

AA  
 AB  
 AC  
 AD  
**AE**  
 AF  
 AK  
 AL  
 AO  
 AP  
 AR  
 KA  
 KL  
 KM  
 KO  
 KU  
 KYE  
 X

**AE** NAHT SUTURE SUTURA SUTURE SUTURA

Mikro-Nadelhalter mit Rundgriff  
 Micro-Needle Holders with Pen-Type Handle  
 Micro-Porta-agujas con mango redondo  
 Micro-Porte-aiguilles à manches rondes  
 Micro-Portaghi con manici rotondi



**AE 630/18**  
 18,0 cm/7"



**AE 631/18**  
 18,0 cm/7"



**AE 632/18**  
 18,0 cm/7"



**AE 633/18**  
 18,0 cm/7"

NAHT SUTURE SUTURA SUTURE SUTURA

Mikro-Nadelhalter  
 Micro-Needle Holders  
 Micro-Porta-agujas  
 Micro-Porte-aiguilles  
 Micro-Portaghi

AA  
 AB  
 AC  
 AD  
**AE**  
 AF  
 AK  
 AL  
 AO  
 AP  
 AR  
 KA  
 KL  
 KM  
 KO  
 KU  
 KYE  
 X



**AE 680/16**  
**AE 680/18**

16,5 cm/6 1/2"  
 18,0 cm/7"

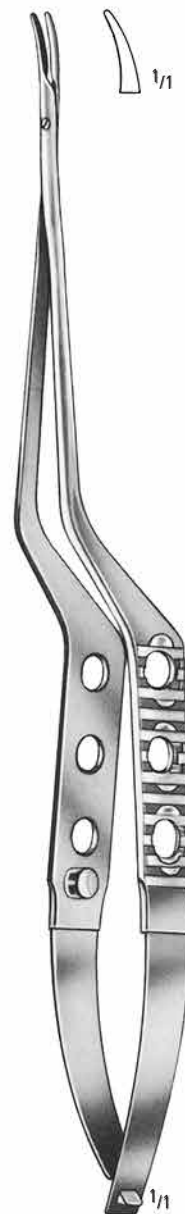

**AE 681/16**  
**AE 681/18**



**AE** NAHT SUTURE SUTURA SUTURE SUTURA

Reverdin-Nadeln, Unterbindungsnadeln  
 Reverdin Needles, Ligature Needles  
 Agujas de Reverdin, Agujas para ligaduras  
 Aiguilles de Reverdin, Aiguilles à ligatures  
 Aghi di Reverdin, Aghi per legatura



1/2

**REVERDIN**  
 14,0 cm/5 1/2"



1/1

Fig. 1  
**AE 700/01**



1/1

2  
**AE 700/02**



1/1

3  
**AE 700/03**



1/1

4  
**AE 700/04**

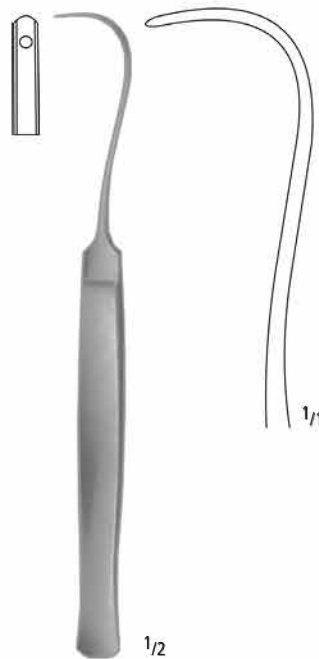

1/2

**SYME**  
**AE 753/17**  
 17,0 cm/6 3/4"

NAHT SUTURE SUTURA SUTURE SUTURA

Unterbindungsnadeln  
Ligature Needles  
Agujas para ligaduras  
Aiguilles à ligatures  
Aghi per legatura

AA  
AB  
AC  
AD  
AE  
AF  
AK  
AL  
AO  
AP  
AR  
KA  
KL  
KM  
KO  
KU  
KYE  
X



**DE LA ROZA**  
**AE 767/01**  
12,0 cm/4<sup>3</sup>/<sub>4</sub>"

**DE LA ROZA**  
**AE 767/02**  
12,0 cm/4<sup>3</sup>/<sub>4</sub>"

**HESSBERG**  
**AE 768/15**  
15,0 cm/6"

**JACOBI**  
**AE 769/14**  
14,0 cm/5<sup>1</sup>/<sub>2</sub>"

**KRONECKER**  
**AE 770/01**  
15,0 cm/6"

**KRONECKER**  
**AE 770/02**  
15,0 cm/6"

**AE** NAHT SUTURE SUTURA SUTURE SUTURA

Wundklammerzängchen  
Suture Forceps  
Pinzas para agrafes  
Pincés pour agrafes  
Pinze per agrafes



**MICHEL**  
**AE 850/12**  
12,0 cm/4<sup>3</sup>/<sub>4</sub>"



**COLLIN**  
**AE 852/13**  
13,0 cm/5"

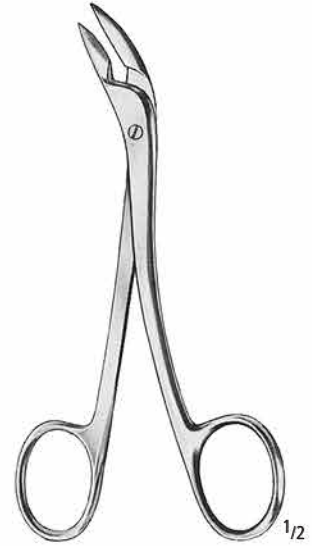

**RICHTER-HEATH**  
**AE 853/14**  
14,0 cm/5<sup>1</sup>/<sub>2</sub>"



**WACHENFELDT**  
**AE 855/01**  
12,5 cm/5"



**HEGENBARTH**  
**AE 856/12**  
12,5 cm/5"



**MICHEL**  
**AE 858/12**  
12,0 cm/4<sup>3</sup>/<sub>4</sub>"

NAHT SUTURE SUTURA SUTURE SUTURA

Wundklammerzängchen, -pinzetten und Wundklammern  
 Suture Forceps and Clips  
 Pinzas para agrafes y agrafes  
 Pincas pour agrafes et agrafes  
 Pinze per agrafes ed agrafes



**LANGE**  
**AE 859/10**  
 10,0 cm/4"



**CHILDE**  
**AE 860/01**  
 18,0 cm/7"



**CHILDE**  
**AE 860/02**  
 18,0 cm/7"

Verkaufseinheit: 1000 Stück  
 Unit for Sale: 1000 each  
 Unidad de venta: 1000 piezas  
 Unité de vente: 1000 pièces  
 Unità di vendita: 1000 pezzi



**MICHEL**

Artikel Nr.	Größen sizes tamaños dimensions dimensioni mm	
<b>AE 870/08</b>	7,5 x 1,75	
<b>AE 870/11</b>	11 x 2,5	
<b>AE 870/12</b>	12 x 3	
<b>AE 870/14</b>	14 x 3	
<b>AE 870/16</b>	16 x 3	
<b>AE 870/18</b>	18 x 3	
<b>AE 870/20</b>	20 x 3	

AA  
 AB  
 AC  
 AD  
**AE**  
 AF  
 AK  
 AL  
 AO  
 AP  
 AR  
 KA  
 KL  
 KM  
 KO  
 KU  
 KYE  
 X





Weitere Instrumente der Bereiche AF-AR finden Sie in unserem Katalog „Allgemeines Instrumentarium“ in den Gruppen AF-AR.

For further instruments of the section AF-AR kindly refer to our catalogue „General Instruments“, sections AF-AR.

Para instrumentos adicionales del este grupo AF-AR, por favor consulte nuestro catálogo de „Instrumental de uso general“, grupos AF-AR.

Pour instruments supplémentaires AF-AR, consultez notre catalogue „Instrumentation Generale“, sections AF-AR.

Per altri strumenti de questo gruppo AF-AR, consultare il nostro catalogo „Strumentazione Generale“, gruppi AF-AR.

# AF-AR

nopa<sup>®</sup> instruments

Tupferzangen	Seite	129-134
Sponge Forceps	Page	129-134
Pinzas para pólipos	Página	129-134
Pinces à pansements	Page	129-134
Pinze per polipi	Pagina	129-134
Wundhaken	Seite	135-152
Retractors	Page	135-152
Separadores	Página	135-152
Ecarteurs	Page	135-152
Divaricatori	Pagina	135-152
Sonden	Seite	153-155
Probes	Page	153-155
Sondas	Página	153-155
Sondes	Page	153-155
Sonde	Pagina	153-155
Punktion/Kanülen	Seite	156-162
Puncture/Special Needles	Page	156-162
Punción/Agujas especiales	Página	156-162
Ponction/Aiguilles spéciales	Page	156-162
Puntura/Aghi speciali	Pagina	156-162
Narkose	Seite	163-180
Anaesthesia	Page	163-180
Anestesia	Página	163-180
Anesthésie	Page	163-180
Anestesia	Pagina	163-180
Diagnostik	Seite	181-194
Diagnostics	Page	181-194
Diagnóstico	Página	181-194
Diagnostic	Page	181-194
Diagnostica	Pagina	181-194



Schwammzangen  
Sponge Holding Forceps  
Pinzas para esponjas  
Pinces à éponges  
Pinze per spugne

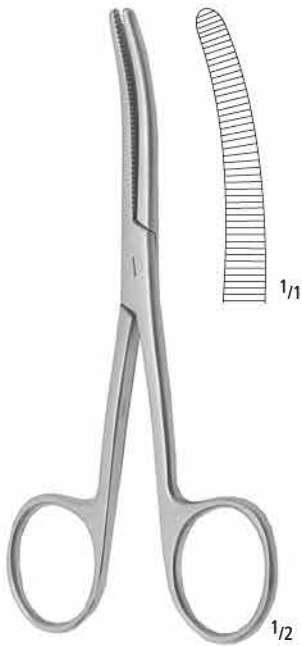

**BRYANT**  
**AF 040/13**  
13,0 cm/5"

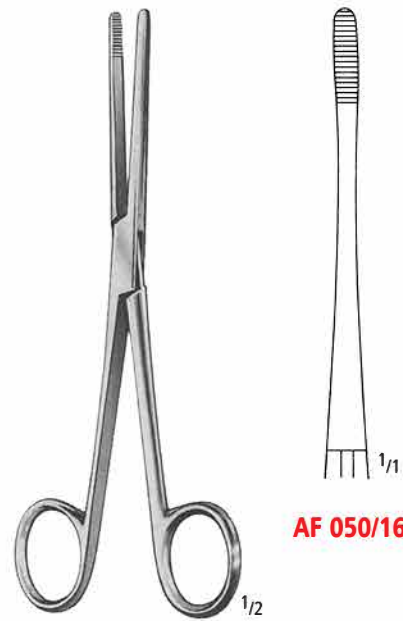

**LISTER**  
13,0 cm/5" **AF 050/13**  
16,0 cm/6<sup>1</sup>/<sub>4</sub>" **AF 050/16**  
18,0 cm/7" **AF 050/18**

**AF 050/16**

Korn- und Tupferzangen, Schwammzangen  
 Polypus and Dressing Forceps, Sponge Holding Forceps  
 Pinzas para pólipos, tapones y esponjas  
 Pincas à pansements, à tampons et à éponges  
 Pinze per polipi, tamponi e spugne



**GROSS-MAIER**  
**AF 100/20**  
**AF 100/25**

20,0 cm/8"  
 25,0 cm/10"

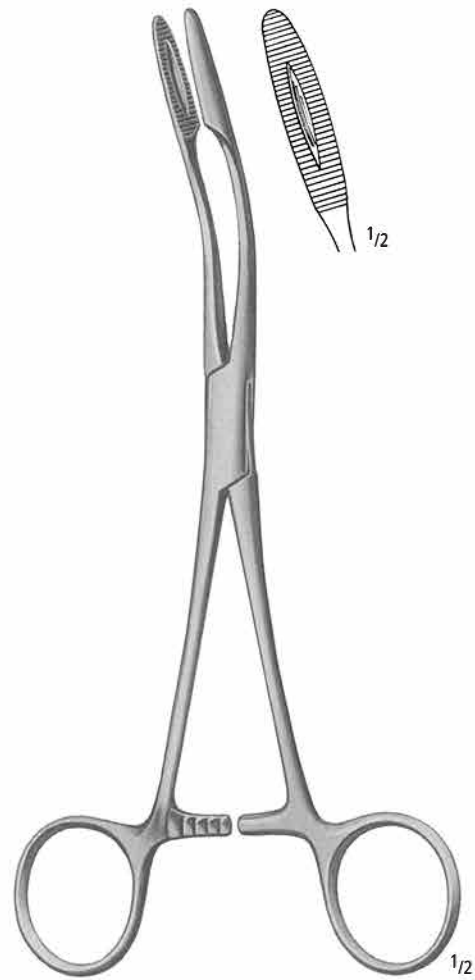

**GROSS-MAIER**  
**AF 101/20**  
**AF 101/25**

AA  
 AB  
 AC  
 AD  
 AE  
**AF**  
 AK  
 AL  
 AO  
 AP  
 AR  
 KA  
 KL  
 KM  
 KO  
 KU  
 KYE  
 X

Korn- und Tupferzangen, Schwammzangen  
 Polypus and Dressing Forceps, Sponge Holding Forceps  
 Pinzas para pólipos, tapones y esponjas  
 Pincas à pansements, à tampons et à éponges  
 Pinze per polipi, tamponi e spugne



**GROSS-MAIER**  
**AF 102/20**  
**AF 102/25**

20,0 cm/8"  
 25,0 cm/10"

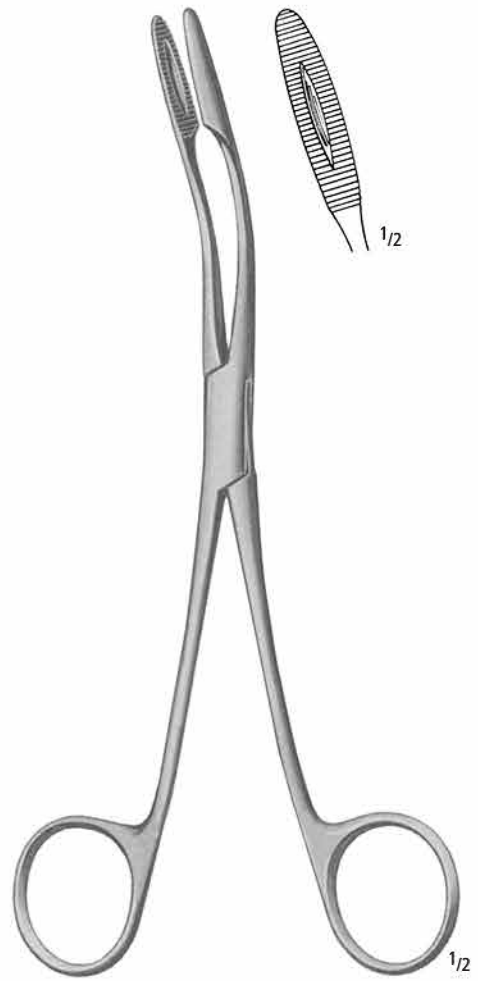

**GROSS-MAIER**  
**AF 103/20**  
**AF 103/25**

TUPFERZANGEN SPONGE FORCEPS PINZAS PARA POLIPOS PINCES A PANSEMENTS PINZE PER POLIPI

Korn- und Tupferzangen, Schwammzangen  
 Polypus and Dressing Forceps, Sponge Holding Forceps  
 Pinzas para pólipos, tapones y esponjas  
 Pincas à pansements, à tampons et à éponges  
 Pinze per polipi, tamponi e spugne



**DUPLAY**  
**AF 176/20**  
 20,5 cm/8"



**DUPLAY**  
**AF 177/20**  
 20,5 cm/8"



**FOERSTER-BALLENGER**



**AF 200/18**  
**AF 200/20**

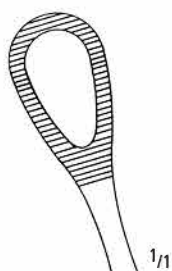

**AF 201/18** 18,0 cm/7"  
**AF 201/20** 20,0 cm/8"



**AF 202/18**  
**AF 202/20**

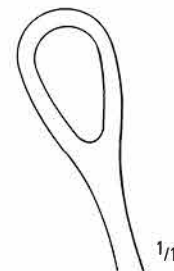

**AF 203/18**  
**AF 203/20**

AA  
 AB  
 AC  
 AD  
 AE  
**AF**  
 AK  
 AL  
 AO  
 AP  
 AR  
 KA  
 KL  
 KM  
 KO  
 KU  
 KYE  
 X



Korn- und Tupferzangen, Schwammzangen  
 Polypus and Dressing Forceps, Sponge Holding Forceps  
 Pinzas para pólipos, tapones y esponjas  
 Pincas à pansements, à tampons et à éponges  
 Pinze per polipi, tamponi e spugne

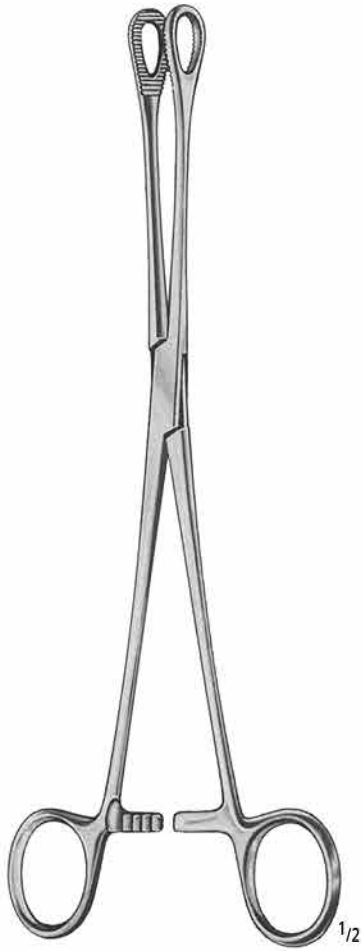

**FOERSTER-BALLENGER**  
 25,0 cm/10"

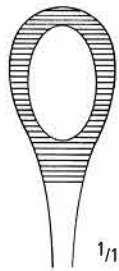

**AF 200/25**

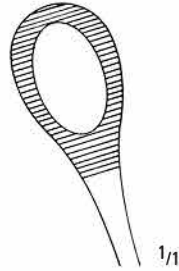

**AF 201/25**



**AF 202/25**

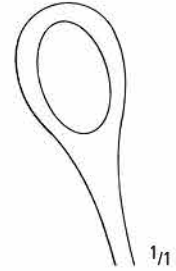

**AF 203/25**

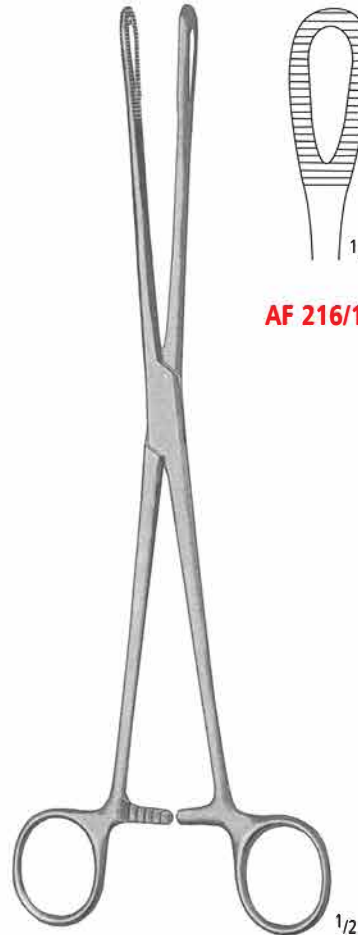

**RAMPLEY**  
 18,0 cm/7"

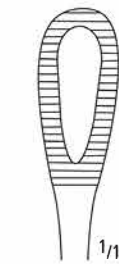

**AF 216/18**

Feine Wundhaken  
Delicate Hooks  
Ganchos  
Crochets très fins  
Divaricatori sottili



**GILLIES**  
**AK 020/01**  
18,0 cm/7"



**GILLIES**  
**AK 020/02**  
18,0 cm/7"



**KILNER**  
**AK 022/15**  
15,0 cm/6"



**FRAZIER**  
**AK 024/13**  
13,0 cm/5"



**AK 026/01**



**KLEINERT-KUTZ**  
**AK 026/02**  
16,0 cm/6 1/4"



**AK 026/03**

AA  
AB  
AC  
AD  
AE  
AF  
**AK**  
AL  
AO  
AP  
AR  
KA  
KL  
KM  
KO  
KU  
KYE  
X

Feine Wundhaken  
 Delicate Hooks  
 Ganchos  
 Crochets très fins  
 Divaricatori sottili

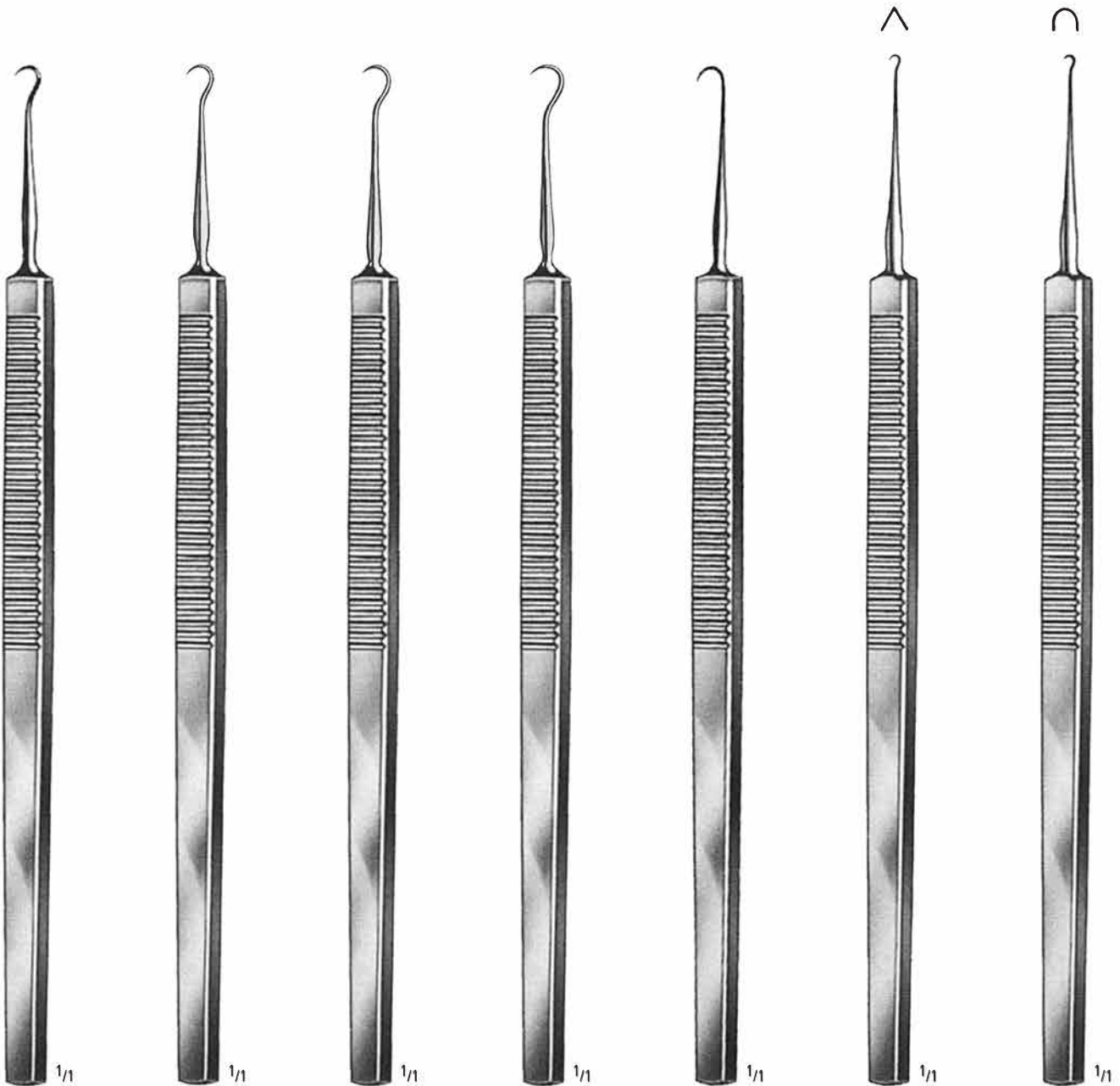

**AK 028/01**  
 16,0 cm/6<sup>1</sup>/<sub>4</sub>"

**AK 028/02**  
 16,0 cm/6<sup>1</sup>/<sub>4</sub>"

**AK 028/03**  
 16,0 cm/6<sup>1</sup>/<sub>4</sub>"

**AK 028/04**  
 16,0 cm/6<sup>1</sup>/<sub>4</sub>"

**O' CONNOR**  
**AK 030/16**  
 16,0 cm/6<sup>1</sup>/<sub>4</sub>"

**GRAEFE**  
**AK 032/01**  
 16,0 cm/6<sup>1</sup>/<sub>4</sub>"

**GRAEFE**  
**AK 032/02**  
 16,0 cm/6<sup>1</sup>/<sub>4</sub>"

WUNDHAKEN RETRACTORS SEPARADORES ECARTEURS DIVARICATORI

Feine Wundhaken  
Delicate Hooks  
Ganchos  
Crochets très fins  
Divaricatori sottili

AA  
AB  
AC  
AD  
AE  
AF  
AK  
AL  
AO  
AP  
AR  
KA  
KL  
KM  
KO  
KU  
KYE  
X



**CUSHING**  
28,0 cm/11"



**AK 034/01**



**AK 034/02**



**CUSHING**  
19,0 cm/7 1/2"



**AK 036/01**



**AK 036/02**

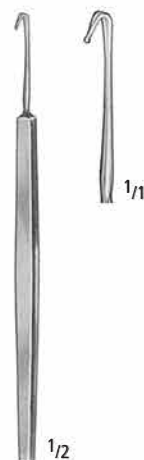

**MOLDESTAD**  
**AK 038/13**  
13,0 cm/5"



**AK 040/05**  
5 mm



**AK 040/07**  
7 mm

17,0 cm/6 3/4"



**AK 042/10**  
Ø 1,0 mm



**AK 042/12**  
Ø 1,2 mm



18,5 cm/7 1/8"



**AK 044/11**  
11,0 cm/4 1/8"

**AK** WUNDHAKEN RETRACTORS SEPARADORES ECARTEURS DIVARICATORI

Feine Wundhaken  
Delicate Hooks  
Ganchos  
Crochets très fins  
Divaricatori sottili

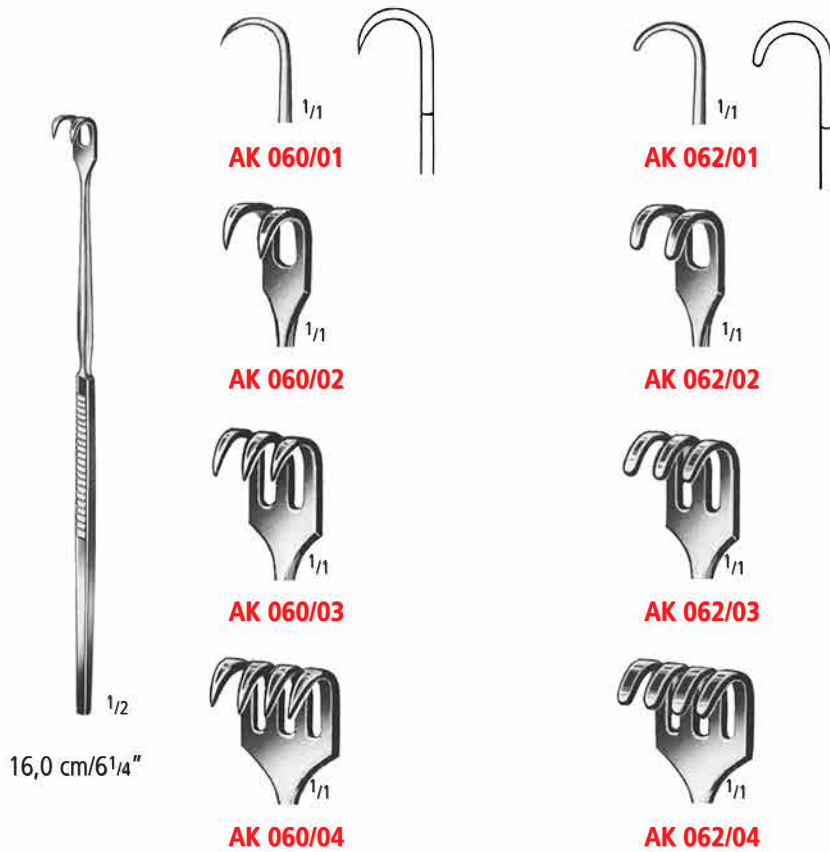
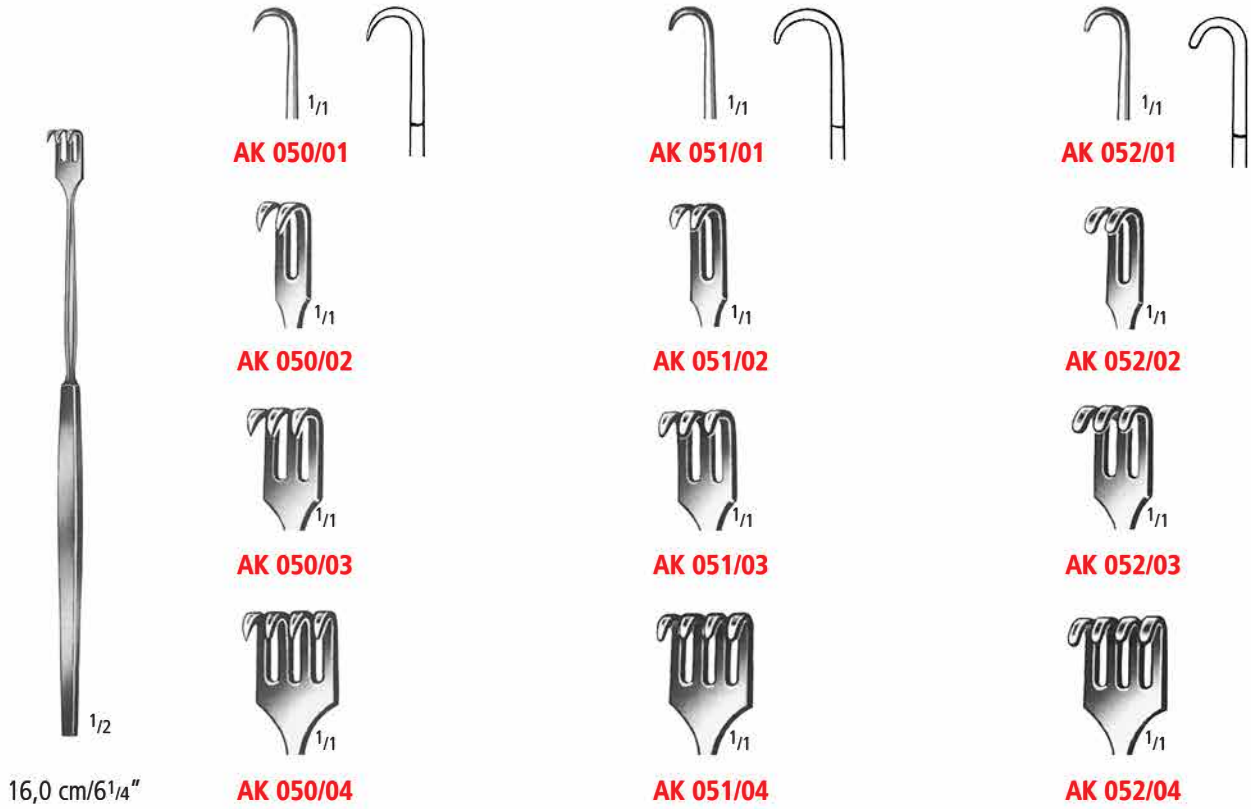



WUNDHAKEN RETRACTORS SEPARADORES ECARTEURS DIVARICATORI

Feine Wundhaken  
Delicate Hooks  
Ganchos  
Crochets très fins  
Divaricatori sottili



flexibel  
flexible  
flexible  
flexible  
flessibile

16,0 cm/6 1/4"

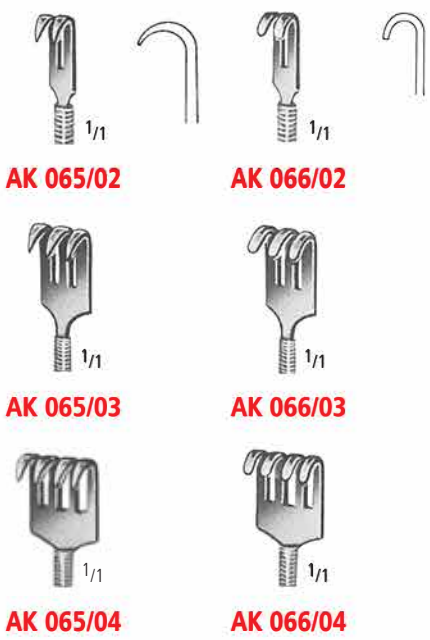

AK 065/02

AK 066/02

AK 065/03

AK 066/03

AK 065/04

AK 066/04



JOSEPH  
AK 070/16  
16,0 cm/6 1/4"



JOSEPH  
16,0 cm/6 1/4"

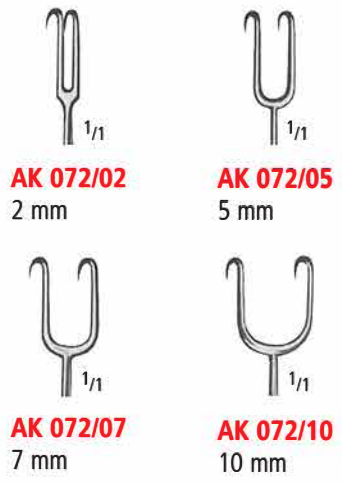

AK 072/02  
2 mm

AK 072/05  
5 mm

AK 072/07  
7 mm

AK 072/10  
10 mm



GUTHRIE  
16,0 cm/6 1/4"

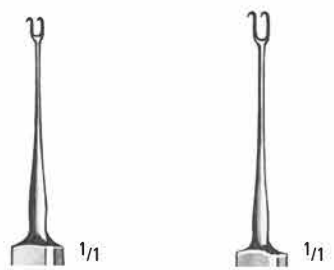

AK 074/01

AK 074/02



ROLLET  
AK 076/13  
13,0 cm/5"



KNAPP  
13,0 cm/5"



AK 077/13

AK 078/13

AA  
AB  
AC  
AD  
AE  
AF  
AK  
AL  
AO  
AP  
AR  
KA  
KL  
KM  
KO  
KU  
KYE  
X

Feine Wundhaken  
Delicate Hooks  
Ganchos  
Crochets très fins  
Divaricatori sottili



**MEYERDING**  
18,0 cm/7"



**AK 080/01**  
18 x 7 mm



**AK 080/02**  
16 x 5 mm



**AK 080/03**  
7 x 4 mm



**AK 080/04**  
10 x 3 mm



**AK 080/05**  
7 x 4 mm



**AK 080/06**  
4 x 10 mm



**SENN-GREEN**  
15,0 cm/6"



**AK 082/10**  
10 x 6 mm



**AK 082/20**  
22 x 8 mm

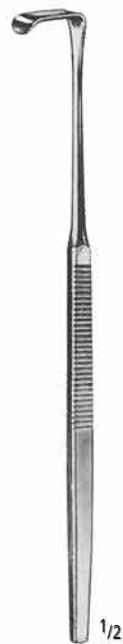

**MINI-LANGENBECK**  
16,0 cm/6¼"



**AK 086/10**  
10 x 6 mm



**AK 086/17**  
17 x 5 mm



**AK 086/20**  
20 x 6 mm



**AK 086/22**  
22 x 8 mm

WUNDHAKEN RETRACTORS SEPARADORES ECARTEURS DIVARICATORI

Feine Wundhaken  
Delicate Hooks  
Ganchos  
Crochets très fins  
Divaricatori sottili

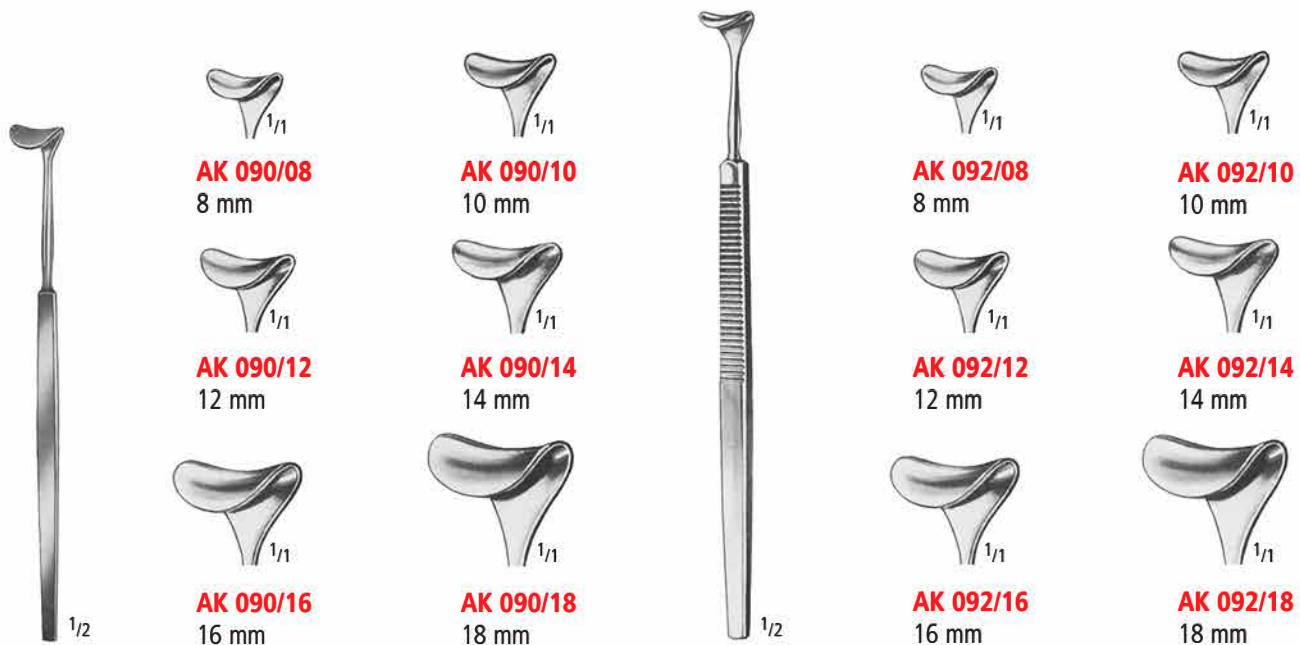

**DESMARRES**  
13,0 cm/5"

**DESMARRES**  
16,0 cm/6 1/4"

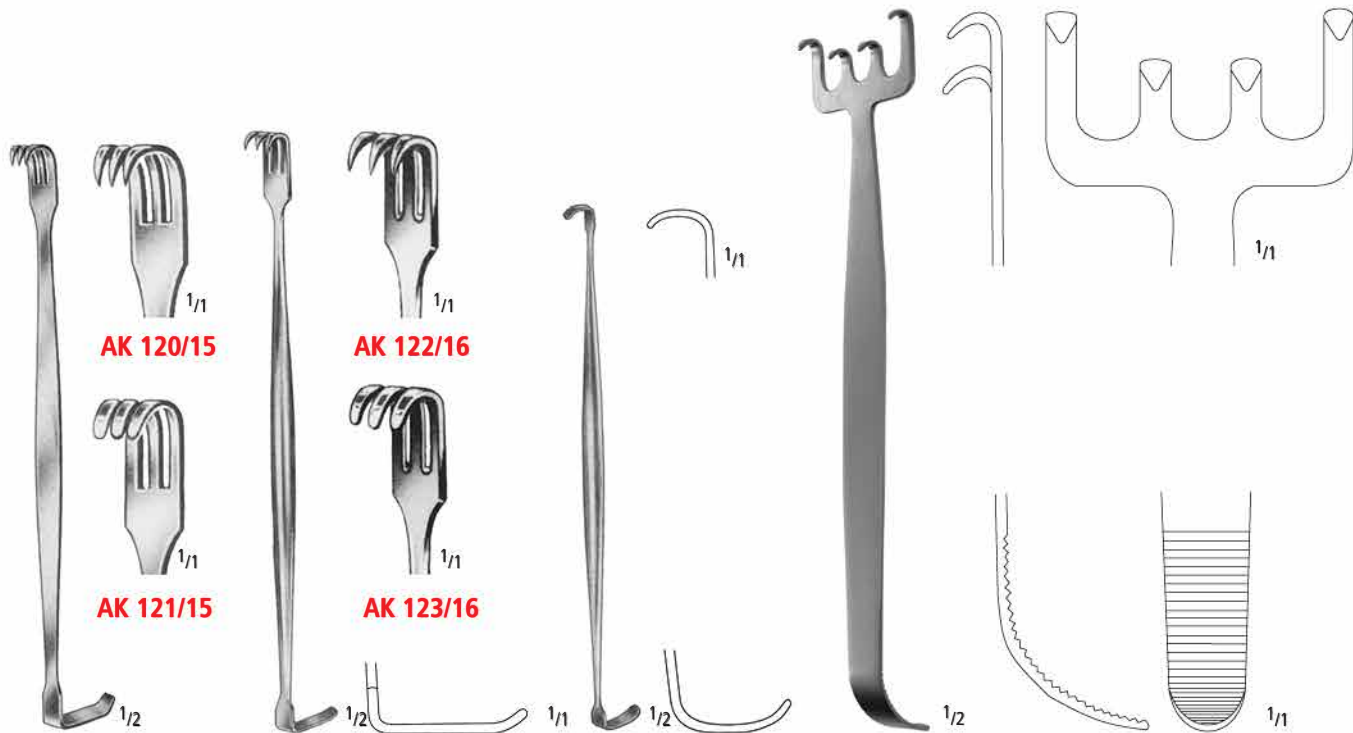

**BABY-SENN-MILLER**  
15,0 cm/6"

**SENN-MILLER**  
16,0 cm/6 1/4"

**RAGNELL-DAVIS**  
**AK 125/14**  
14,0 cm/5 1/2"

**WALTER**  
**AK 128/19**  
19,0 cm/7 1/2"

AA  
AB  
AC  
AD  
AE  
AF  
AK  
AL  
AO  
AP  
AR  
KA  
KL  
KM  
KO  
KU  
KYE  
X



**VOLKMANN**  
21,5 cm/8<sup>1</sup>/<sub>2</sub>"



**AK 150/01**



**AK 150/02**



**AK 150/03**



**AK 150/04**



**AK 150/06**



<sup>1</sup>/<sub>1</sub>



**AK 151/01**



**AK 151/02**



**AK 151/03**



**AK 151/04**



**AK 151/06**



<sup>1</sup>/<sub>2</sub>



**AK 152/01**



**AK 152/02**



**AK 152/03**



**AK 152/04**



**AK 152/06**



<sup>1</sup>/<sub>1</sub>



**KOCHER**  
22,0 cm/8<sup>3</sup>/<sub>4</sub>"



**AK 160/01**



**AK 160/02**



**AK 160/03**



**AK 160/04**



**AK 160/06**

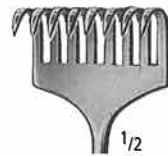

**AK 160/08**



<sup>1</sup>/<sub>1</sub>



**AK 161/01**



**AK 161/02**



**AK 161/03**



**AK 161/04**



**AK 161/06**



**AK 161/08**



<sup>1</sup>/<sub>1</sub>



**AK 162/01**



**AK 162/02**



**AK 162/03**



**AK 162/04**



**AK 162/06**

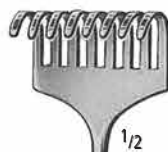

**AK 162/08**



<sup>1</sup>/<sub>1</sub>



**OBWEGESER**  
**AK 225/02**  
 24,0 cm/9 1/2"

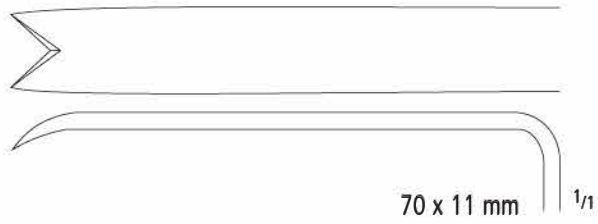

**KOCHER-LANGENBECK**  
 21,5 cm/8 1/2"



**AK 233/01**  
 25 x 6 mm



**AK 233/02**  
 35 x 8 mm



**AK 233/03**  
 35 x 11 mm



**AK 233/04**  
 35 x 15 mm



**AK 233/05**  
 40 x 11 mm



**AK 233/06**  
 55 x 11 mm

AA  
 AB  
 AC  
 AD  
 AE  
 AF  
**AK**  
 AL  
 AO  
 AP  
 AR  
 KA  
 KL  
 KM  
 KO  
 KU  
 KYE  
 X



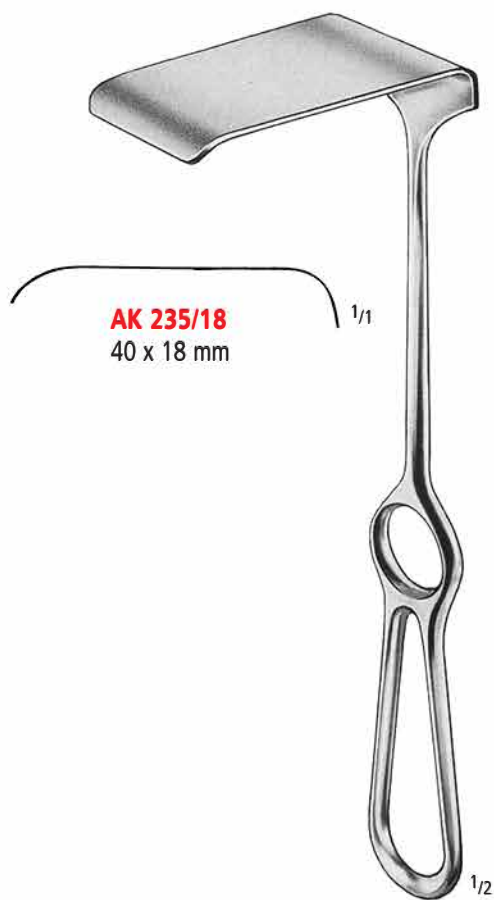

**AK 235/18**  
40 x 18 mm

<sup>1/2</sup>

**KOCHER**  
23,0 cm/9"



**AK 236/01**  
44 x 16 mm

<sup>1/1</sup>

<sup>1/2</sup>

**SAUERBRUCH**  
22,5 cm/8<sup>3</sup>/<sub>4</sub>"

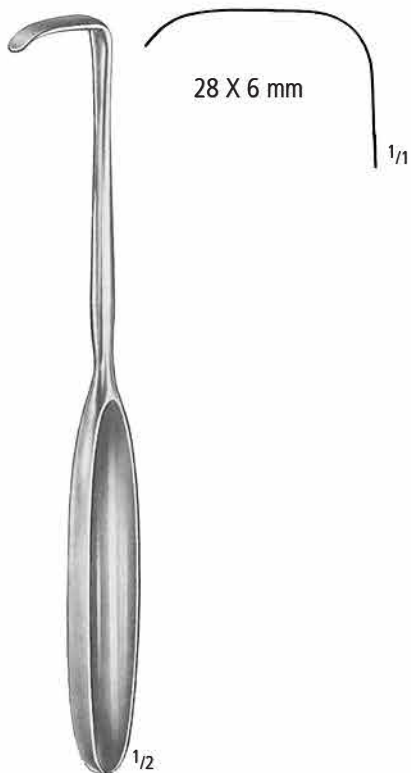

28 X 6 mm

<sup>1/1</sup>

<sup>1/2</sup>

**LAHEY**  
**AK 242/19**  
19,0 cm/7<sup>1</sup>/<sub>2</sub>"



12 X 14 mm

<sup>1/1</sup>

<sup>1/2</sup>

**LITTLE**  
**AK 243/20**  
20,0 cm/8"

WUNDHAKEN RETRACTORS SEPARADORES ECARTEURS DIVARICATORI



**MIDDELDORPF**  
**AK 244/17-30**



14 X 17 mm

**AK 244/17**  
**AK 245/17**  
21,5 cm/8<sup>1</sup>/<sub>2</sub>"



20 X 22 mm

**AK 244/22**  
**AK 245/22**  
22,0 cm/8<sup>3</sup>/<sub>4</sub>"



26 X 30 mm

**AK 244/30**  
**AK 245/30**  
23,5 cm/9<sup>1</sup>/<sub>3</sub>"



**MIDDELDORPF**  
**AK 245/17-30**

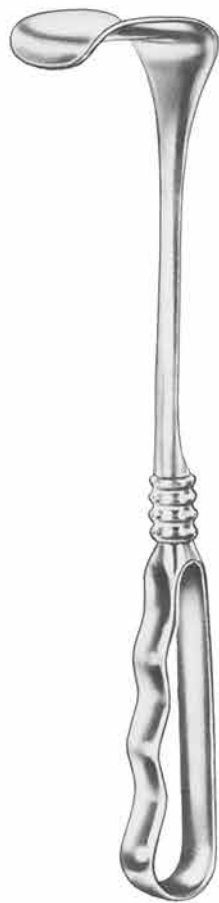

**RICHARDSON (KELLY)**  
24,0 cm/9<sup>1</sup>/<sub>2</sub>"



**AK 247/01**  
28 X 20 mm



**AK 247/02**  
36 x 28 mm



**AK 247/03**  
44 X 38 mm



**AK 247/04**  
52 X 22 mm



**AK 247/05**  
65 X 50 mm

AA  
AB  
AC  
AD  
AE  
AF  
**AK**  
AL  
AO  
AP  
AR  
KA  
KL  
KM  
KO  
KU  
KYE  
X

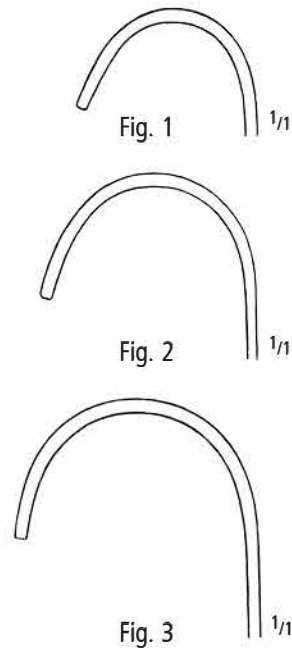
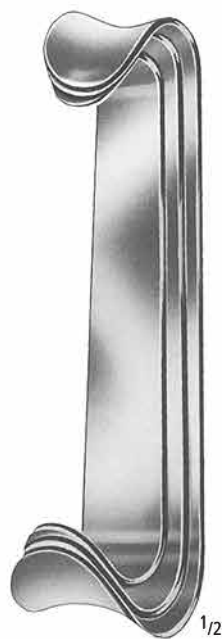

**ROUX**

16,5 cm/6 1/2"

- Fig. 1+2+3 **AK 350/00**
- Fig. 1 **AK 350/01**
- Fig. 2 **AK 350/02**
- Fig. 3 **AK 350/03**

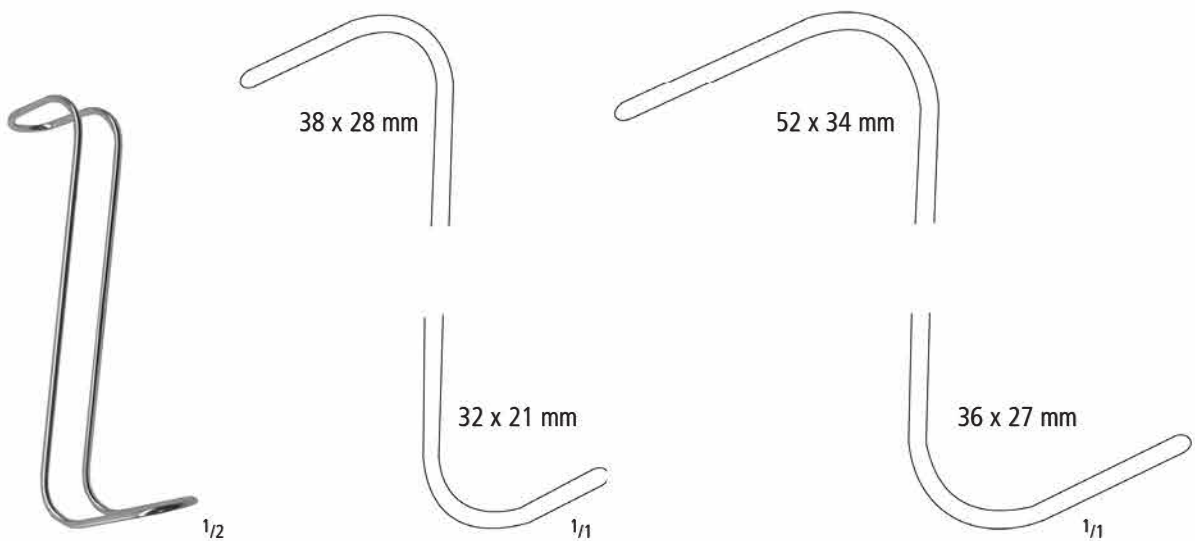

**COLLIN-HARTMANN**

- 14,0 cm/5 1/2" **AK 351/14**
- 16,0 cm/6 1/4" **AK 351/16**



Fig. 1 **AK 352/01**  
Fig. 2 **AK 352/02**

**FARABEUF**  
**AK 352/00** Fig. 1+2  
12,0 cm/4<sup>3</sup>/<sub>4</sub>"



Fig. 1 **AK 354/01**  
Fig. 2 **AK 354/02**

**FARABEUF**  
**AK 354/00** Fig. 1+2  
15,0 cm/6"



Fig. 1 **AK 373/01**  
Fig. 2 **AK 373/02**

**PARKER**  
**AK 373/00** Fig. 1+2  
13,5 cm/5<sup>1</sup>/<sub>4</sub>"

**AK** WUNDHAKEN RETRACTORS SEPARADORES ECARTEURS DIVARICATORI

Wundhaken mit Kaltlichtbeleuchtung  
 Retractor with fibreoptic illumination  
 Retractor con iluminación de fibra óptica  
 Rétracteur avec illumination par fibre optique  
 Divaricatore con illuminazione a fibre ottiche



**FERREIRA**  
**AK 451/10**  
 10 cm/4"

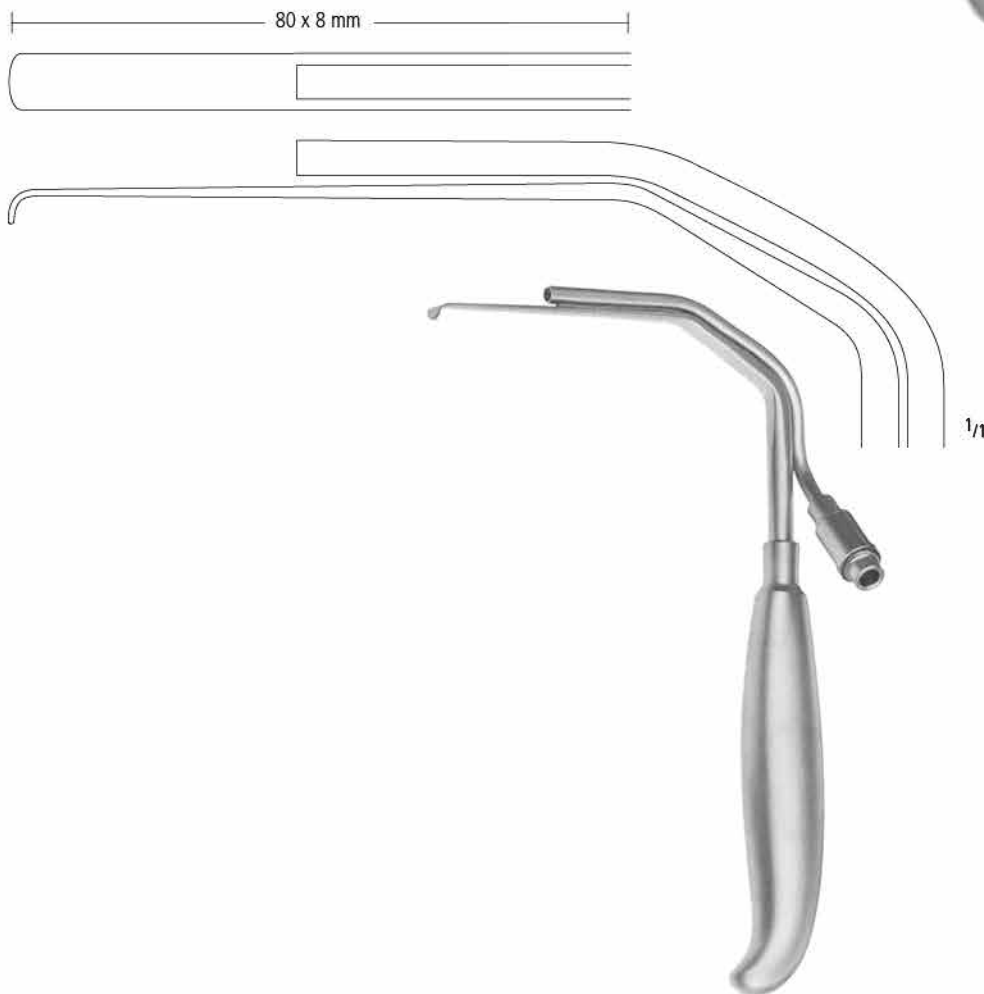

**AK 452/15**

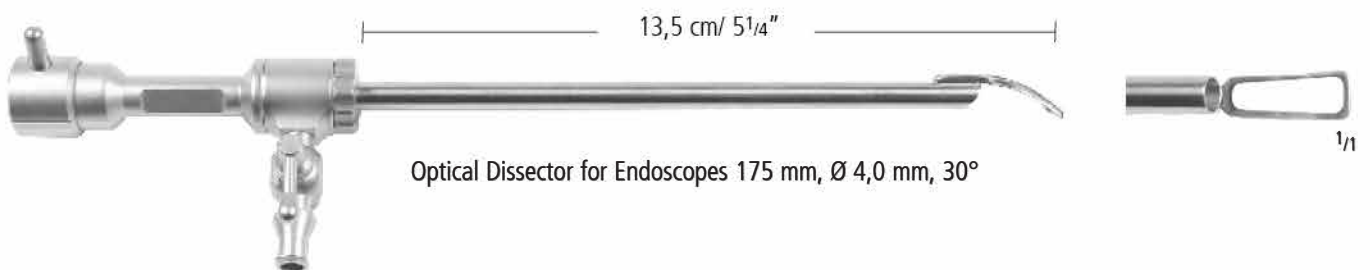

Optical Dissector for Endoscopes 175 mm, Ø 4,0 mm, 30°

**AK 456/01**



WUNDHAKEN RETRACTORS SEPARADORES ECARTEURS DIVARICATORI

Selbsthaltende Wundsperrer  
Selfretaining Retractors  
Separadores autoestaticos  
Ecarteurs autostatiques  
Divaricatori autostatici

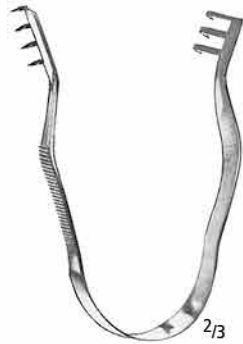

**FINSEN**

5,0 cm/2"  
7,0 cm/2<sup>3</sup>/<sub>4</sub>"

AK 500/05    AK 501/05  
AK 500/07    AK 501/07



AK 502/10    AK 503/10  
10,0 cm/4"

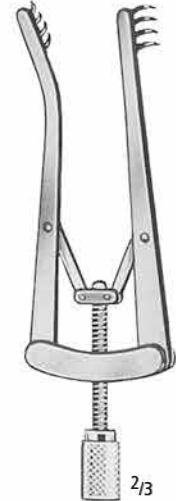

**ALM**

7,0 cm/2<sup>3</sup>/<sub>4</sub>"  
10,0 cm/4"

AK 506/07    AK 507/07  
AK 506/10    AK 507/10



**JANSEN**

AK 510/10    AK 511/10  
10,0 cm/4"



**JANSEN**

AK 512/10    AK 513/10  
10,0 cm/4"



**SNITMAN**

AK 514/10    AK 515/10  
10,5 cm/4<sup>1</sup>/<sub>4</sub>"

AA  
AB  
AC  
AD  
AE  
AF  
AK  
AL  
AO  
AP  
AR  
KA  
KL  
KM  
KO  
KU  
KYE  
X

**AK** WUNDHAKEN RETRACTORS SEPARADORES ECARTEURS DIVARICATORI

Selbsthaltende Wundsperrer  
 Selfretaining Retractors  
 Separadores autoestaticos  
 Ecarteurs autostatiques  
 Divaricatori autostatici



**WEITLANER-BABY**  
**AK 519/14**  
 14,0 cm/5 1/2"

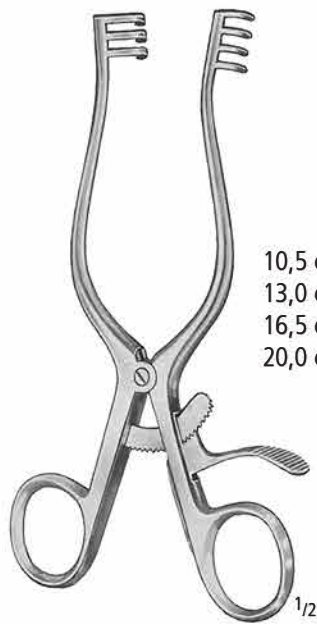

**WEITLANER**

10,5 cm/4 1/4"  
 13,0 cm/5"  
 16,5 cm/6 1/2"  
 20,0 cm/8"

2 x 3  
 3 x 4  
 3 x 4  
 3 x 4

^  
**AK 522/10**  
**AK 524/13**  
**AK 526/16**  
**AK 528/20**

∩  
**AK 523/10**  
**AK 525/13**  
**AK 527/16**  
**AK 529/20**

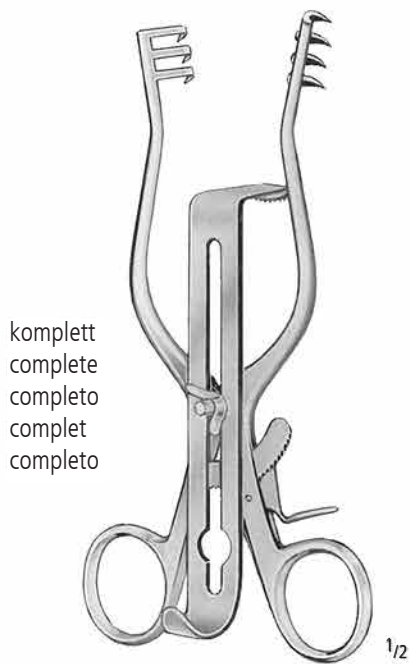

komplett  
 complete  
 completo  
 complet  
 completo

**HENLEY**

^      ∩  
**AK 536/00**    **AK 537/00**  
 16,5 cm/6 1/2"

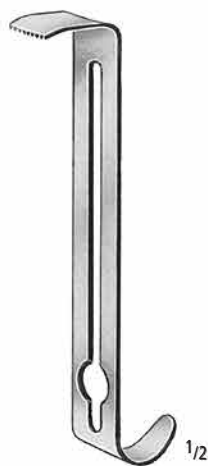

19 mm x 16 mm  
**AK 536/19**



25 mm x 16 mm  
**AK 536/25**

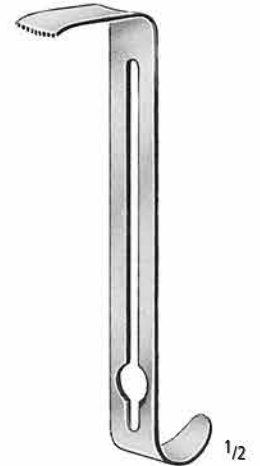

32 mm x 16 mm  
**AK 536/32**

WUNDHAKEN RETRACTORS SEPARADORES ECARTEURS DIVARICATORI

Selbsthaltende Wundsperrer  
Selfretaining Retractors  
Separadores autoestaticos  
Ecarteurs autostatiques  
Divaricatori autostatici



**MILLIGAN**  
 ^      ^  
**AK 538/13**    **AK 539/13**  
 13,0 cm/5"



**SCHUHKNECHT**  
 ^      ^  
**AK 542/14**    **AK 543/14**  
 14,0 cm/5 1/2"



**WULLSTEIN**  
 ^      ^  
 10,5 cm/4 1/4"    **AK 544/10**    **AK 545/10**  
 13,0 cm/5"      **AK 544/13**    **AK 545/13**  
 16,0 cm/6 1/4"    **AK 544/16**    **AK 545/16**



**MOLLISON**  
 ^      ^  
**AK 550/15**    **AK 551/15**  
 15,0 cm/6"

AA  
AB  
AC  
AD  
AE  
AF  
**AK**  
AL  
AO  
AP  
AR  
KA  
KL  
KM  
KO  
KU  
KYE  
X

**AK** WUNDHAKEN RETRACTORS SEPARADORES ECARTEURS DIVARICATORI

Selbsthaltende Wundsperrer  
 Selfretaining Retractors  
 Separadores autoestaticos  
 Ecarteurs autostatiques  
 Divaricatori autostatici

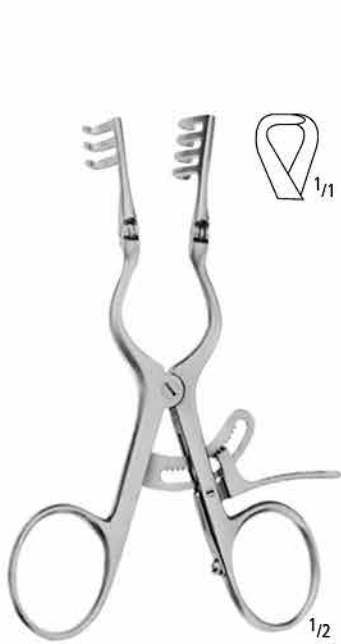

**ADSON-BABY**  
**AK 562/14**  
 14,0 cm/5 1/2"



**CONE**  
 ^ 3 x 4 ^  
**AK 564/13** **AK 565/13**  
 13,0 cm/5"



**SCALP-CONTOUR**  
 ^ ^  
**AK 574/14** **AK 575/14**  
 14,0 cm/5 1/2"



**PLESTER**  
**AK 590/10** **AK 590/13**  
 10,0 cm/4" 13,0 cm/5"



**PLESTER-R**  
**AK 591/10** **AK 591/13**  
 10,0 cm/4" 13,0 cm/5"



**PLESTER-L**  
**AK 592/10** **AK 592/13**  
 10,0 cm/4" 13,0 cm/5"



**TÜBINGER MODELL**  
**AK 594/16** **AK 594/18**  
 16,5 cm/6 1/2" 18,0 cm/7"

SONDEN PROBES SONDAS SONDES SONDE

Sonden  
Probes  
Sondas  
Sondes  
Sonde



1/2



1/2



1/2

Silber  
silver  
de plata  
en argent  
d'argento



1/2

- 11,5 cm/4 1/2"
- 13,0 cm/5"
- 14,5 cm/5 3/4"
- 16,0 cm/6 1/4"
- 18,0 cm/7"
- 20,0 cm/8"
- 25,0 cm/10"

- |  |                  |                  |
|--|------------------|------------------|
|  | 1,0 mm           | 2,0 mm           |
|  | <b>AL 001/11</b> | <b>AL 002/11</b> |
|  | <b>AL 001/13</b> | <b>AL 002/13</b> |
|  | <b>AL 001/14</b> | <b>AL 002/14</b> |
|  | <b>AL 001/16</b> | <b>AL 002/16</b> |
|  | <b>AL 001/18</b> | <b>AL 002/18</b> |
|  | <b>AL 001/20</b> | <b>AL 002/20</b> |
|  | <b>AL 001/25</b> | <b>AL 002/25</b> |

- AL 003/11**
- AL 003/13**
- AL 003/14**
- AL 003/16**
- AL 003/18**
- AL 003/20**
- AL 003/25**

**MYRTLE LEAF**

- AL 007/14**
- AL 007/16**
- AL 007/18**
- AL 007/20**

- STACKE**  
**AL 013/10**  
10,5 cm/4 1/4"  
Ø 1,0 mm



1/2



1/2

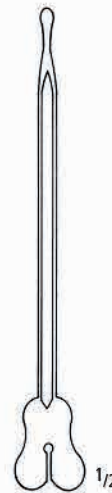

1/2



1/2

- 11,5 cm/4 1/2"
- 13,0 cm/5"
- 14,5 cm/5 3/4"
- 16,0 cm/6 1/4"
- 18,0 cm/7"
- 20,0 cm/8"

- AL 015/11**
- AL 015/13**
- AL 015/14**
- AL 015/16**
- AL 015/18**
- AL 015/20**

**DOYEN**

- AL 017/14**

- AL 020/11**
- AL 020/13**
- AL 020/14**
- AL 020/16**
- AL 020/18**

**NELATON**

- AL 022/16**

AA  
AB  
AC  
AD  
AE  
AF  
AK  
AL  
AO  
AP  
AR  
KA  
KL  
KM  
KO  
KU  
KYE  
X



**AL** SONDEN PROBES SONDAS SONDES SONDE

Sonden und Watteträger  
 Probes and Cotton Applicators  
 Sondas y Porta-algodones  
 Sondes et Porte-coton  
 Sonde e Portacotone



**BRODIE**  
**AL 026/20**  
 20,0 cm/8"

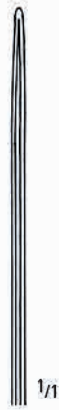

**LOCKHART-MUMMERY**  
 Fig. 1  
**AL 030/01**



**LOCKHART-MUMMERY**  
 Fig. 2  
**AL 030/02**

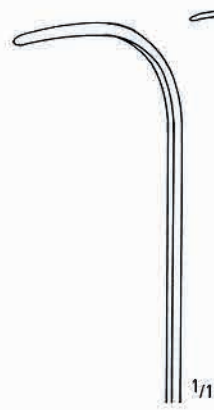

**LOCKHART-MUMMERY**  
 Fig. 3  
**AL 030/03**

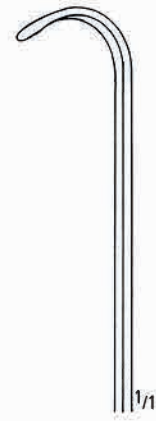

**LOCKHART-MUMMERY**  
 Fig. 4  
**AL 030/03**



**PRATT**  
 21,0 cm/8 1/4"



**AL 035/01**



**AL 035/02**



**AL 035/03**



**FARRELL**

0,9 mm  
 12,0 cm/4 3/4"  
**AL 100/12**  
 14,0 cm/5 1/2"  
**AL 100/14**

**AL 100/16**

1,2 mm

**AL 100/18**



**FARRELL**

0,9 mm  
 12,0 cm/4 3/4"  
**AL 120/12**  
 14,0 cm/5 1/2"  
**AL 120/14**

**AL 120/16**

1,2 mm

**AL 120/18**

SONDEN PROBES SONDAS SONDES SONDE

Watteträger  
Cotton Applicators  
Porta-algodones  
Porte-coton  
Portacotone



**UCKERMANN**  
**AL 160/16**  
16,0 cm/6 1/4"

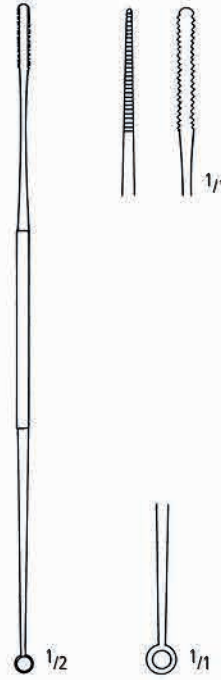

**JOBSON-HORNE**  
**AL 162/18**  
18,0 cm/7"

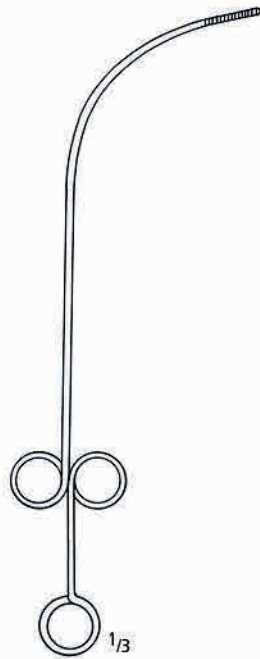

**FEIN**  
**AL 170/28**  
28,0 cm/11"



**TOBOLD**  
**AL 171/25**  
25,0 cm/10"

AA  
AB  
AC  
AD  
AE  
AF  
AK  
**AL**  
AO  
AP  
AR  
KA  
KL  
KM  
KO  
KU  
KYE  
X

Trokare  
Trocars  
Trócares  
Trocarts  
Trequarti

**LICHTWITZ**

1,0 x 100 mm	<b>AO 178/10</b>
1,5 x 100 mm	<b>AO 178/15</b>
1,8 x 100 mm	<b>AO 178/18</b>
2,0 x 100 mm	<b>AO 178/20</b>

Saugrohre  
Suction Tubes  
Tubos de aspiración  
Canules d'aspiration  
Cannule per aspirazione



**YANKAUER**  
**AO 400/00**  
27,0 cm/10<sup>3</sup>/<sub>4</sub>"



**WALTON-YANKAUER**  
**AO 404/00**  
32,5 cm/13"

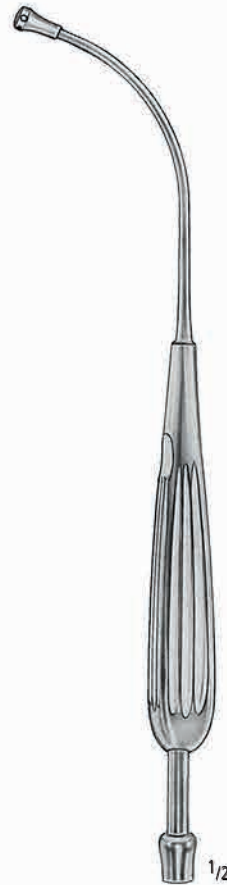

**ANDREWS-PYNCHON**  
**AO 406/00**  
23,5 cm/9<sup>1</sup>/<sub>3</sub>"



**DE BAKKEY**  
**AO 408/00**  
27,5 cm/10<sup>3</sup>/<sub>4</sub>"

AA  
AB  
AC  
AD  
AE  
AF  
AK  
AL  
AO  
AP  
AR  
KA  
KL  
KM  
KO  
KU  
KYE  
X

Saugrohre  
Suction Tubes  
Tubos de aspiración  
Canules d'aspiration  
Cannule per aspirazione

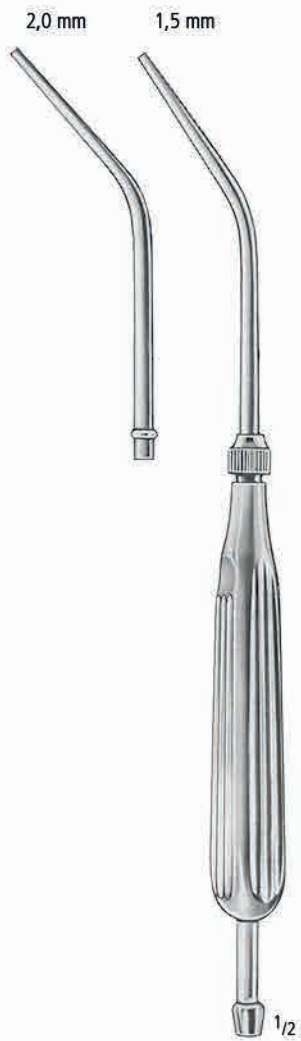

**COUPLAND**  
**AO 410/00**



**POOLE**  
**AO 420/22**  
10,0 mm



**POOLE**  
**AO 421/22**  
8,0 mm



**BABY-POOLE**  
**AO 422/20**  
5,5 mm



Saugrohre  
Suction Tubes  
Tubos de aspiración  
Canules d'aspiration  
Cannule per aspirazione



**FRAZIER**

- 6 Charr. **AO 430/06**
- 8 Charr. **AO 430/08**
- 10 Charr. **AO 430/10**
- 12 Charr. **AO 430/12**
- 15 Charr. **AO 430/15**



**PLESTER**

- 1,5 mm **AO 432/15**
- 2,0 mm **AO 432/20**
- 2,5 mm **AO 432/25**
- 3,0 mm **AO 432/30**



**NIJMEGEN**

- 1,0 mm x 70 mm **AO 433/10**
- 1,5 mm x 70 mm **AO 433/15**
- 2,0 mm x 70 mm **AO 433/20**
- 2,5 mm x 70 mm **AO 433/25**
- 3,0 mm x 70 mm **AO 433/30**
- 4,0 mm x 70 mm **AO 433/40**



**FERGUSSON**

- 5 Charr. **AO 434/05**
- 6 Charr. **AO 434/06**
- 7 Charr. **AO 434/07**
- 8 Charr. **AO 434/08**
- 9 Charr. **AO 434/09**
- 10 Charr. **AO 434/10**
- 12 Charr. **AO 434/12**



**EICKEN-KILLIAN**

- 13,0 cm/5"
- Ø 2,5 mm **AO 436/02**
- Ø 3,0 mm **AO 436/03**
- Ø 4,0 mm **AO 436/04**

complete with  
suction tube  
+ cannula 0,5 mm  
+ cannula 0,7 mm  
+ cannula 0,9 mm



**WULLSTEIN**

- MICRO**
- AO 438/00**

AA  
AB  
AC  
AD  
AE  
AF  
AK  
AL  
AO  
AP  
AR  
KA  
KL  
KM  
KO  
KU  
KYE  
X

Saugrohre  
Suction Tubes  
Tubos de aspiración  
Canules d'aspiration  
Cannule per aspirazione

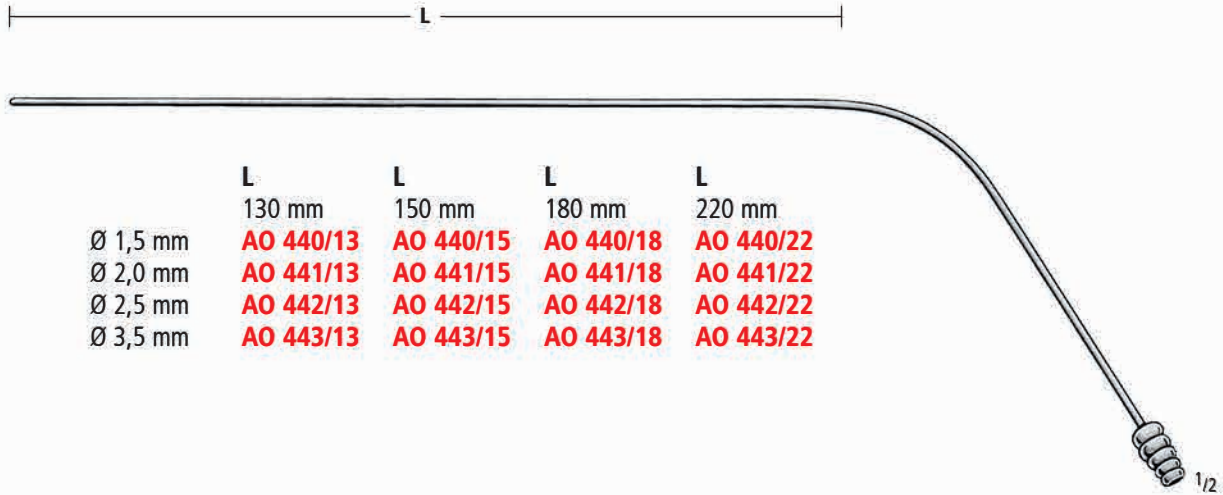

**ADSON**  
**AO 450/04**  
21,0 cm/8<sup>1</sup>/<sub>4</sub>"  
Ø 4,0 mm

Weitere Sauginstrumente siehe Kapitel KL, KM, KO  
More suction instruments in chapter KL, KM, KO  
Para otras Tubos de aspiration ver seccion KL, KM, KO  
D'autres canules d'aspiration groupe KL, KM, KO  
Altre cannule per aspirazione vedi gruppo KL, KM, KO

Spritzen  
Syringes  
Jeringas  
Seringues  
Siringhe

AA  
AB  
AC  
AD  
AE  
AF  
AK  
AL  
AO  
AP  
AR  
KA  
KL  
KM  
KO  
KU  
KYE  
X



50 ml **AO 869/05**

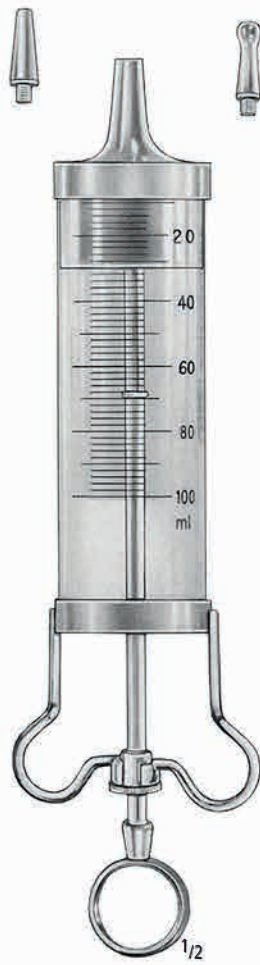

**JANET**  
50 ml **AO 870/05**  
100 ml **AO 870/10**  
150 ml **AO 870/15**  
200 ml **AO 870/20**



50 ml **AO 871/05**  
100 ml **AO 871/10**  
150 ml **AO 871/15**  
200 ml **AO 871/20**



**disposable**  
20 ml **AO 875/02**

Hähne und Verbindungsstücke  
 Stopcocks and connecting pieces  
 Llaves y Piezas de conexión  
 Robinets et Raccords  
 Rubinetti e Raccordiostotomi aspiranti



**AO 910/00**



**AO 911/00**



**AO 912/00**

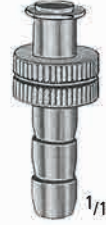

**AO 913/00**



**AO 915/00**



**AO 916/00**



**AO 917/00**



**AO 918/00**

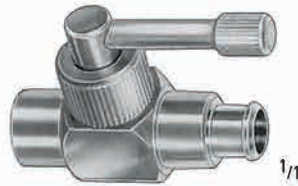

**AO 920/00**

links  
 left  
 izquierda  
 gauche  
 sinistra



**AO 921/01**

rechts  
 right  
 derecha  
 droite  
 destra

**AO 921/02**

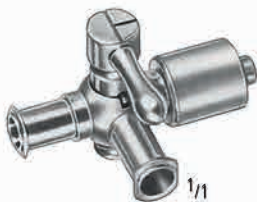

**AO 922/00**



**AO 923/00**



**AO 924/00**

Laryngoskope  
Laryngoscopes  
Laringoscopios  
Laryngoscopes  
Laringoscopi

# McINTOSH



- AP 250/00** Halogen (90 mm + 110 mm + 135 mm)
- AP 250/50** LED (90 mm + 110 mm + 135 mm)
- AP 250/01** Halogen (75 mm + 90 mm + 110 mm + 135 mm)
- AP 250/51** LED (75 mm + 90 mm + 110 mm + 135 mm)

komplett - complete - completo - complet - completo



		Halogen	LED
Fig. 0,	55 mm	<b>AP 252/00</b>	<b>AP 252/50</b>
Fig. 1,	75 mm	<b>AP 252/01</b>	<b>AP 252/51</b>
Fig. 2,	90 mm	<b>AP 252/02</b>	<b>AP 252/52</b>
Fig. 3,	110 mm	<b>AP 252/03</b>	<b>AP 252/53</b>
Fig. 4,	135 mm	<b>AP 252/04</b>	<b>AP 252/54</b>

AA  
AB  
AC  
AD  
AE  
AF  
AK  
AL  
AO  
AP  
AR  
KA  
KL  
KM  
KO  
KU  
KYE  
X



Laryngoskope  
Laryngoscopes  
Laringoscopios  
Laryngoscopes  
Laringoscopi

## FOREGGER (WISCONSIN)



- AP 260/00** Halogen (110 mm + 140 mm + 170 mm)
- AP 260/50** LED (110 mm + 140 mm + 170 mm)
- AP 260/01** Halogen (95 mm + 110 mm + 140 mm + 170 mm)
- AP 260/51** LED (95 mm + 110 mm + 140 mm + 170 mm)

komplett - complete - completo - complet - completo



		Halogen	LED
Fig. 00,	55 mm	<b>AP 262/10</b>	<b>AP 262/60</b>
Fig. 0,	70 mm	<b>AP 262/00</b>	<b>AP 262/50</b>
Fig. 1,	95 mm	<b>AP 262/01</b>	<b>AP 262/51</b>
Fig. 2,	110 mm	<b>AP 262/02</b>	<b>AP 262/52</b>
Fig. 3,	140 mm	<b>AP 262/03</b>	<b>AP 262/53</b>
Fig. 4,	170 mm	<b>AP 262/04</b>	<b>AP 262/54</b>

Laryngoskope  
Laryngoscopes  
Laringoscopios  
Laryngoscopes  
Laringoscopi

# MILLER



- AP 270/00** Halogen (130 mm + 170 mm + 180 mm)
- AP 270/50** LED (130 mm + 170 mm + 180 mm)
- AP 270/01** Halogen (80 mm + 130 mm + 170 mm + 180 mm)
- AP 270/51** LED (80 mm + 130 mm + 170 mm + 180 mm)

komplett - complete - completo - complet - completo



		Halogen	LED
Fig. 00,	45 mm	<b>AP 272/10</b>	<b>AP 272/60</b>
Fig. 0,	55 mm	<b>AP 272/00</b>	<b>AP 272/50</b>
Fig. 1,	80 mm	<b>AP 272/01</b>	<b>AP 272/51</b>
Fig. 2,	130 mm	<b>AP 272/02</b>	<b>AP 272/52</b>
Fig. 3,	170 mm	<b>AP 272/03</b>	<b>AP 272/53</b>
Fig. 4,	180 mm	<b>AP 272/04</b>	<b>AP 272/54</b>

AA  
AB  
AC  
AD  
AE  
AF  
AK  
AL  
AO  
AP  
AR  
KA  
KL  
KM  
KO  
KU  
KYE  
X

Laryngoskope  
Laryngoscopes  
Laringoscopios  
Laryngoscopes  
Laringoscopi



**AP 280/19**  
Ø 19 mm



**AP 280/28**  
Ø 28 mm



**AP 280/37**  
Ø 37 mm



**AP 282/00**  
Fig. 2-4  
Halogen



**AP 282/01**  
Fig. 2-4  
LED



**AP 284/00**  
Fig. 0-1  
Halogen



**AP 284/01**  
Fig. 0-1  
LED

Kaltlicht Laryngoskope  
 Fibre Optic Laryngoscopes  
 Laringoscopios con luz fría  
 Laryngoscopes à lumière froide  
 Laringoscopi a luce fredda

## McINTOSH FIBRE OPTIC



- AP 300/00** Halogen (80 mm + 105 mm + 130 mm)
- AP 300/50** LED (80 mm + 105 mm + 130 mm)
- AP 300/01** Halogen (70 mm + 80 mm + 105 mm + 130 mm)
- AP 300/51** LED (70 mm + 80 mm + 105 mm + 130 mm)

komplett - complete - completo - complet - completo



		Halogen	LED
Fig. 0,	55 mm	<b>AP 302/00</b>	<b>AP 302/50</b>
Fig. 1,	70 mm	<b>AP 302/01</b>	<b>AP 302/51</b>
Fig. 2,	80 mm	<b>AP 302/02</b>	<b>AP 302/52</b>
Fig. 3,	105 mm	<b>AP 302/03</b>	<b>AP 302/53</b>
Fig. 4,	130 mm	<b>AP 302/04</b>	<b>AP 302/54</b>

AA  
AB  
AC  
AD  
AE  
AF  
AK  
AL  
AO  
AP  
AR  
KA  
KL  
KM  
KO  
KU  
KYE  
X



Kaltlicht Laryngoskope  
 Fibre Optic Laryngoscopes  
 Laringoscopios con luz fría  
 Laryngoscopes à lumière froide  
 Laringoscopi a luce fredda

# FOREGGER (WISCONSIN) FIBRE OPTIC



- AP 310/00** Halogen (110 mm + 140 mm + 170 mm)
- AP 310/50** LED (110 mm + 140 mm + 170 mm)
- AP 310/01** Halogen (95 mm + 110 mm + 140 mm + 170 mm)
- AP 310/51** LED (95 mm + 110 mm + 140 mm + 170 mm)

komplett - complete - completo - complet - completo



		Halogen	LED
Fig. 0,	70 mm	<b>AP 312/00</b>	<b>AP 312/50</b>
Fig. 1,	95 mm	<b>AP 312/01</b>	<b>AP 312/51</b>
Fig. 2,	110 mm	<b>AP 312/02</b>	<b>AP 312/52</b>
Fig. 3,	140 mm	<b>AP 312/03</b>	<b>AP 312/53</b>
Fig. 4,	170 mm	<b>AP 312/04</b>	<b>AP 312/54</b>



Kaltlicht Laryngoskope  
 Fibre Optic Laryngoscopes  
 Laringoscopios con luz fría  
 Laryngoscopes à lumière froide  
 Laringoscopi a luce fredda

## MILLER FIBRE OPTIC



- AP 320/00** Halogen (80 mm + 130 mm + 170 mm)
- AP 320/50** LED (80 mm + 130 mm + 170 mm)
- AP 320/01** Halogen (80 mm + 130 mm + 170 mm + 180 mm)
- AP 320/51** LED (80 mm + 130 mm + 170 mm + 180 mm)

komplett - complete - completo - complet - completo



		Halogen	LED
Fig. 0,	55 mm	<b>AP 322/00</b>	<b>AP 322/50</b>
Fig. 1,	80 mm	<b>AP 322/01</b>	<b>AP 322/51</b>
Fig. 2,	130 mm	<b>AP 322/02</b>	<b>AP 322/52</b>
Fig. 3,	170 mm	<b>AP 322/03</b>	<b>AP 322/53</b>
Fig. 4,	180 mm	<b>AP 322/04</b>	<b>AP 322/54</b>

AA  
AB  
AC  
AD  
AE  
AF  
AK  
AL  
AO  
AP  
AR  
KA  
KL  
KM  
KO  
KU  
KYE  
X

Kaltlicht Laryngoskope  
 Fibre Optic Laryngoscopes  
 Laringoscopios con luz fría  
 Laryngoscopes à lumière froide  
 Laringoscopi a luce fredda

## FIBRE OPTIC



**AP 340/00**  
 Ø 30 mm



**AP 341/00**  
 Ø 20 mm



**AP 345/01**  
 2,5 V  
 Halogen



**AP 345/02**  
 2,5 V  
 Krypton



**AP 345/03**  
 2,5 V  
 LED

Katheterzangen  
 Catheter Forceps  
 Pinzas para catéteres  
 Pinces pour sondes  
 Pinze per cannule

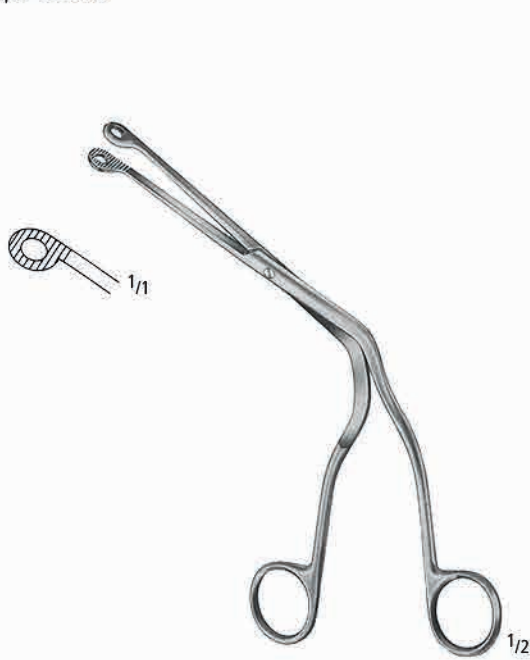

**MAGILL**  
**AP 410/16**  
 16,0 cm/6<sup>1</sup>/<sub>4</sub>"



**MAGILL**  
**AP 410/20**  
 20,0 cm/8"



**MAGILL**  
**AP 410/25**  
 25,0 cm/10"

AA  
 AB  
 AC  
 AD  
 AE  
 AF  
 AK  
 AL  
 AO  
 AP  
 AR  
 KA  
 KL  
 KM  
 KO  
 KU  
 KYE  
 X

Operations-Laryngoskope  
 Operating laryngoscopes  
 Laringoscopios para operaciones  
 Laryngoscopes opératoires  
 Laringoscopi operatori

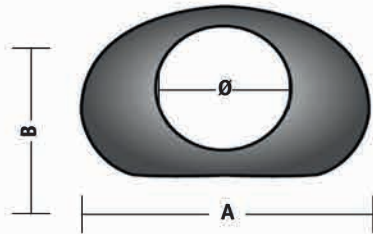

		[mm]			
		L	A	B	Ø
Fig. 1	<b>AP 425/01</b>	135	20	12	11
Fig. 2	<b>AP 425/02</b>	152	21	13	11
Fig. 3	<b>AP 425/03</b>	182	21	13	12
Fig. 4	<b>AP 425/04</b>	172	27	15	14,5
Fig. 5	<b>AP 425/05</b>	172	29	19	16
Fig. 6	<b>AP 425/06</b>	182	26	17	13x18
Fig. 7	<b>AP 425/07</b>	222	26	17	13x18

Fig. 1



**AP 425/01**  
 für Kleinkinder  
 for small children  
 para niños pequeños  
 pour petits enfants  
 per piccolo bambini

Fig. 2



**AP 425/02**  
 für Kinder  
 for children  
 para niños  
 pour enfants  
 per bambini

Fig. 3



**AP 425/03**  
 für kleine Erwachsene  
 for small adults  
 para adultos pequeños  
 pour petits adultes  
 per piccolo adulti

Fig. 4



**AP 425/04**  
 für mittelgroße Erwachsene  
 for mid-size adults  
 para adultos mediano  
 pour moyens adultes  
 per adulti di media altezza

Fig. 5



**AP 425/05**  
 für große Erwachsene  
 for large adults  
 para adultos grande  
 pour grand adultes  
 per grande adulti

Fig. 6



**AP 425/06**  
 für vordere Kommissur  
 for anterior commissure  
 para comisura anterior  
 pour commissure antérieure  
 per commissura anteriore

Fig. 7



**AP 425/07**  
 für lange Häse  
 for long necks  
 para cuellos largos  
 pour long cous  
 per collos longo

Operations-Laryngoskope  
 Operating laryngoscopes  
 Laringoscopios para operaciones  
 Laryngoscopes opératoires  
 Laringoscopi operatori

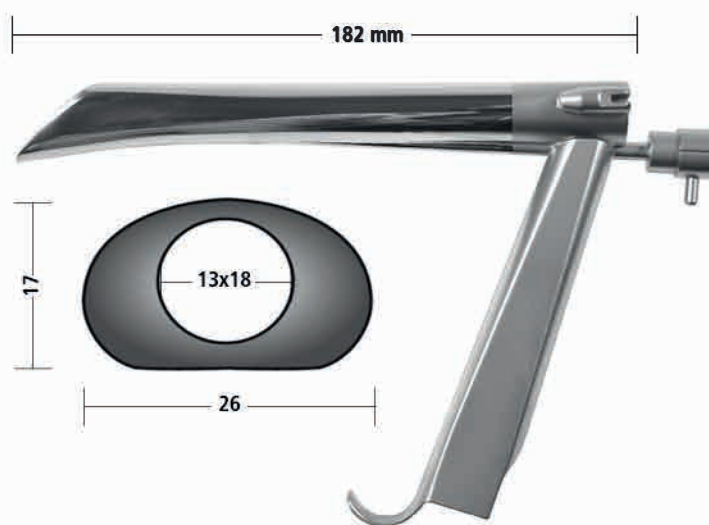
**AP 427/00**18,2 cm/ 7<sup>1</sup>/<sub>4</sub>"

Videolaryngoskop mit Endoskopführung  
 Video laryngoscope with endoscope-guide  
 Laringoscopios para video  
 Laryngoscopes video  
 Laringoscopi video

For use with endoscope  
 175 mm, Ø 4,0 mm

AA

AB

AC

AD

AE

AF

AK

AL

AO

AP

AR

KA

KL

KM

KO

KU

KYE

X



Operations-Laryngoskope  
 Operating laryngoscopes  
 Laringoscopios para operaciones  
 Laryngoscopes opératoires  
 Laringoscopi operatori

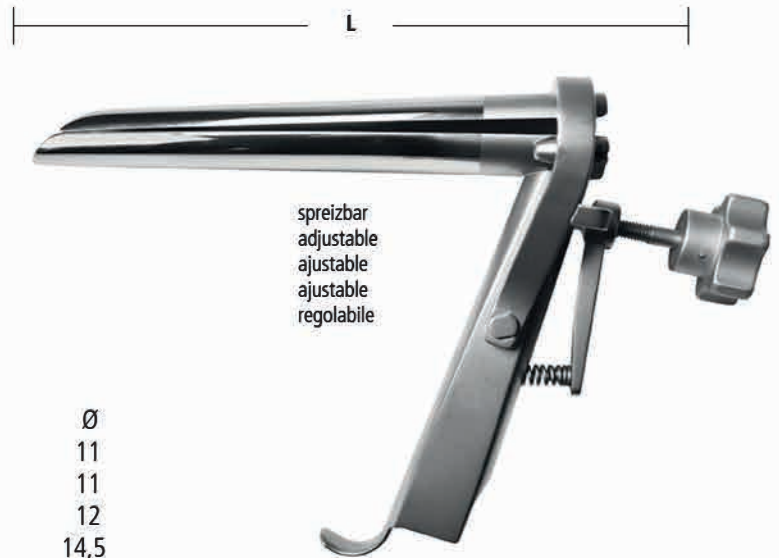
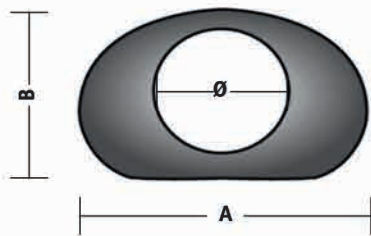

spreizbar  
 adjustable  
 ajustable  
 regolabile

		[mm]			
		L	A	B	Ø
Fig. 1	<b>AP 430/01</b>	135	20	12	11
Fig. 2	<b>AP 430/02</b>	152	21	13	11
Fig. 3	<b>AP 430/03</b>	182	21	13	12
Fig. 4	<b>AP 430/04</b>	172	27	15	14,5
Fig. 5	<b>AP 430/05</b>	172	29	19	16
Fig. 6	<b>AP 430/06</b>	182	26	17	13x18
Fig. 7	<b>AP 430/07</b>	222	26	17	13x18

Fig. 1



**AP 430/01**  
 für Kleinkinder  
 for small children  
 para niños pequeños  
 pour petits enfants  
 per piccolo bambini

Fig. 2



**AP 430/02**  
 für Kinder  
 for children  
 para niños  
 pour enfants  
 per bambini

Fig. 3



**AP 430/03**  
 für kleine Erwachsene  
 for small adults  
 para adultos pequeños  
 pour petits adultes  
 per piccolo adulti

Fig. 4



**AP 430/04**  
 für mittelgroße Erwachsene  
 for mid-size adults  
 para adultos mediano  
 pour moyens adultes  
 per adulti di media altezza

Fig. 5



**AP 430/05**  
 für große Erwachsene  
 for large adults  
 para adultos grande  
 pour grand adultes  
 per grande adulti

Fig. 6



**AP 430/06**  
 für vordere Kommissur  
 for anterior commissure  
 para comisura anterior  
 pour commissure antérieure  
 per commissura anteriore

Fig. 7



**AP 430/07**  
 für lange Hälse  
 for long necks  
 para cuellos largos  
 pour long cous  
 per collos longo

Operations-Laryngoskope  
 Operating laryngoscopes  
 Laringoscopios para operaciones  
 Laryngoscopes opératoires  
 Laringoscopi operatori

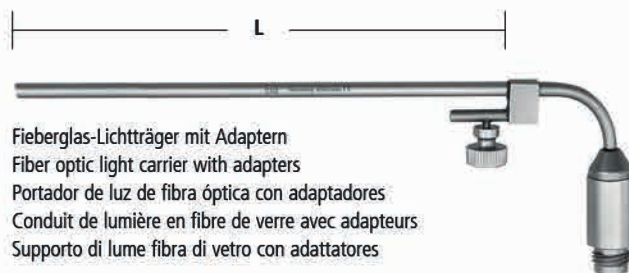

Fiberglas-Lichtträger mit Adaptern  
 Fiber optic light carrier with adapters  
 Portador de luz de fibra óptica con adaptadores  
 Conduit de lumière en fibre de verre avec adapteurs  
 Supporto di lume fibra di vetro con adattatore

**AP 431/01**  
 L = 144 mm

für, for, para, pour, per

**Fig. 1-2**  
**AP 425/01 - AP 425/02**  
**AP 430/01 - AP 430/02**

**AP 431/03**  
 L = 171 mm

**Fig. 3-6**  
**AP 425/03 - AP 425/06**  
**AP 430/03 - AP 430/06**

**AP 431/07**  
 L = 216 mm

**Fig. 7**  
**AP 425/07**  
**AP 430/07**

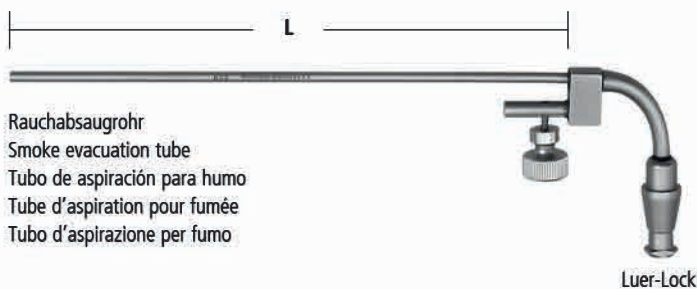

Rauchabsaugrohr  
 Smoke evacuation tube  
 Tubo de aspiración para humo  
 Tube d'aspiration pour fumée  
 Tubo d'aspirazione per fumo

Luer-Lock

**AP 433/01**  
 L = 125 mm

für, for, para, pour, per

**Fig. 1-2**  
**AP 425/01 - AP 425/02**  
**AP 430/01 - AP 430/02**

**AP 433/03**  
 L = 174 mm

**Fig. 3-7**  
**AP 425/03 - AP 425/07**  
**AP 430/03 - AP 430/07**

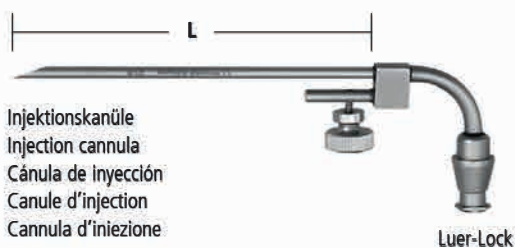

Injektionskanüle  
 Injection cannula  
 Cánula de inyección  
 Canule d'injection  
 Cannula d'iniezione

Luer-Lock

**AP 434/01**  
 L = 120 mm

für, for, para, pour, per

**Fig. 1-7**  
**AP 425/01 - AP 425/07**  
**AP 430/01 - AP 430/07**

AA  
 AB  
 AC  
 AD  
 AE  
 AF  
 AK  
 AL  
 AO  
 AP  
 AR  
 KA  
 KL  
 KM  
 KO  
 KU  
 KYE  
 X

Operations-Laryngoskope für Laser  
 Operating laryngoscopes for laser  
 Laringoscopios para operaciones para láser  
 Laryngoscopes opératoires pour laser  
 Laringoscopi operatori per laser

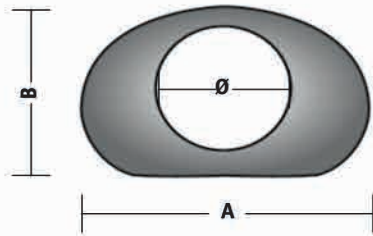

		[mm]			
		L	A	B	Ø
Fig. 1	<b>AP 440/01</b>	135	20	12	11
Fig. 2	<b>AP 440/02</b>	152	21	13	11
Fig. 3	<b>AP 440/03</b>	182	21	13	12
Fig. 4	<b>AP 440/04</b>	172	27	15	14,5
Fig. 5	<b>AP 440/05</b>	172	29	19	16
Fig. 6	<b>AP 440/06</b>	182	26	17	13x18
Fig. 7	<b>AP 440/07</b>	222	26	17	13x18

Fig. 1



**AP 440/01**  
 für Kleinkinder  
 for small children  
 para niños pequeños  
 pour petits enfants  
 per piccolo bambini

Fig. 2



**AP 440/02**  
 für Kinder  
 for children  
 para niños  
 pour enfants  
 per bambini

Fig. 3



**AP 440/03**  
 für kleine Erwachsene  
 for small adults  
 para adultos pequeños  
 pour petits adultes  
 per piccolo adulti

Fig. 4



**AP 440/04**  
 für mittelgroße Erwachsene  
 for mid-size adults  
 para adultos mediano  
 pour moyens adultes  
 per adulti di media altezza

Fig. 5



**AP 440/05**  
 für große Erwachsene  
 for large adults  
 para adultos grande  
 pour grand adultes  
 per grande adulti

Fig. 6



**AP 440/06**  
 für vordere Commissur  
 for anterior commissure  
 para comisura anterior  
 pour commissure antérieure  
 per commissura anteriore

Fig. 7



**AP 440/07**  
 für lange Hälse  
 for long necks  
 para cuellos largos  
 pour long cous  
 per collos longo

Zubehör für Laser Operations-Laryngoskope  
 Accessories for laser operating laryngoscopes  
 Accesorios para láser laringoscopios para operaciones  
 Accessoires pour laser laryngoscopes opératoires  
 Accessori per laser laringoscopi operatori

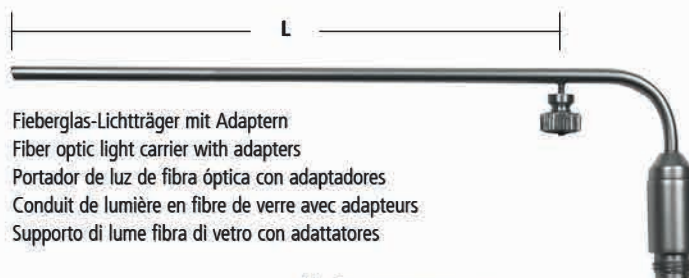

Fieberglas-Lichtträger mit Adaptern  
 Fiber optic light carrier with adapters  
 Portador de luz de fibra óptica con adaptadores  
 Conduit de lumière en fibre de verre avec adapteurs  
 Supporto di lume fibra di vetro con adattatore

**AP 441/01**  
 L = 144 mm

**AP 441/03**  
 L = 171 mm

**AP 441/07**  
 L = 216 mm

für, for, para, pour, per

**Fig. 1-2**  
**AP 440/01 - AP 440/02**

**Fig. 3-6**  
**AP 440/03 - AP 440/06**

**Fig. 7**  
**AP 440/07**



Rauchabsaugrohr  
 Smoke evacuation tube  
 Tubo de aspiración para humo  
 Tube d'aspiration pour fumée  
 Tubo d'aspirazione per fumo

Luer-Lock

**AP 443/01**  
 L = 125 mm

**AP 443/03**  
 L = 174 mm

für, for, para, pour, per

**Fig. 1-2**  
**AP 440/01 - AP 440/02**

**Fig. 3-7**  
**AP 440/03 - AP 440/07**

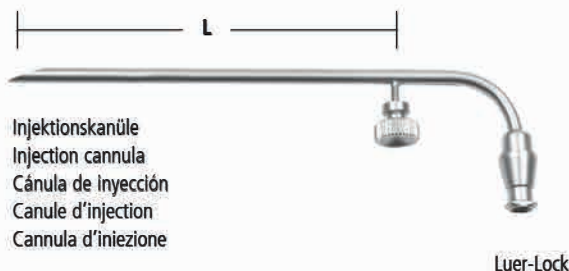

Injektionskanüle  
 Injection cannula  
 Cánula de inyección  
 Canule d'injection  
 Cannula d'iniezione

Luer-Lock

**AP 444/01**  
 L = 120 mm

für, for, para, pour, per

**Fig. 1-7**  
**AP 440/01 - AP 440/07**

AA  
 AB  
 AC  
 AD  
 AE  
 AF  
 AK  
 AL  
 AO  
 AP  
 AR  
 KA  
 KL  
 KM  
 KO  
 KU  
 KYE  
 X



Kaltlicht Laryngoskope  
 Fibre Optic Laryngoscopes  
 Laringoscopios con luz fría  
 Laryngoscopes à lumière froide  
 Laringoscopi a luce fredda

**HOLINGER**

- L = 120 mm = **AP 455/03**
- L = 171 mm = **AP 455/02**
- L = 180 mm = **AP 455/01**

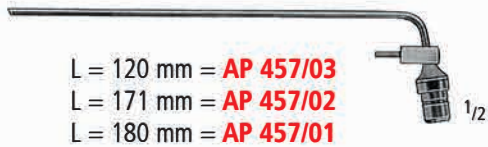
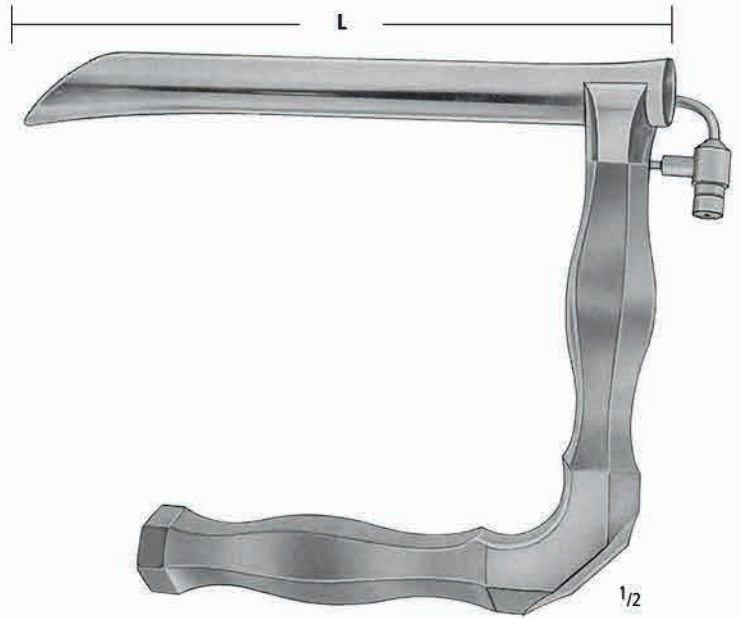

- L = 120 mm = **AP 457/03**
- L = 171 mm = **AP 457/02**
- L = 180 mm = **AP 457/01**

**JACKSON**

- L = 120 mm = **AP 465/12**
- L = 171 mm = **AP 465/17**
- L = 180 mm = **AP 465/18**

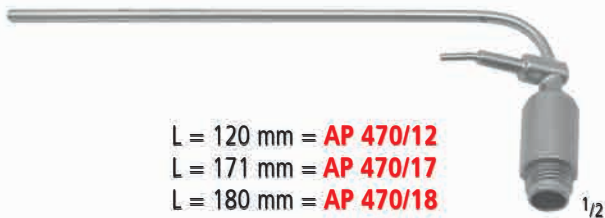
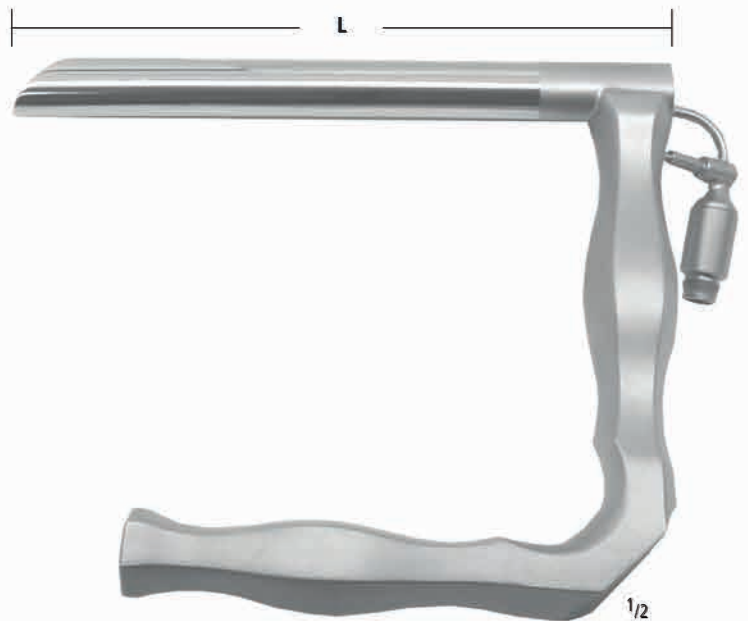

- L = 120 mm = **AP 470/12**
- L = 171 mm = **AP 470/17**
- L = 180 mm = **AP 470/18**

Adapter STORZ, WOLF, ACMI auf Wunsch  
 Adaptor STORZ, WOLF, ACMI on request  
 Adaptador STORZ, WOLF, ACMI sobre pedido  
 Adaptateur STORZ, WOLF, ACMI à la demande  
 Adattatori STORZ, WOLF, ACMI su richiesta



Zubehör für Operations-Laryngoskope  
 Accessories for operating laryngoscopes  
 Accesorios para laringoscopios para operaciones  
 Accessoires pour laryngoscopes opératoires  
 Accessori per laringoscopi operatori

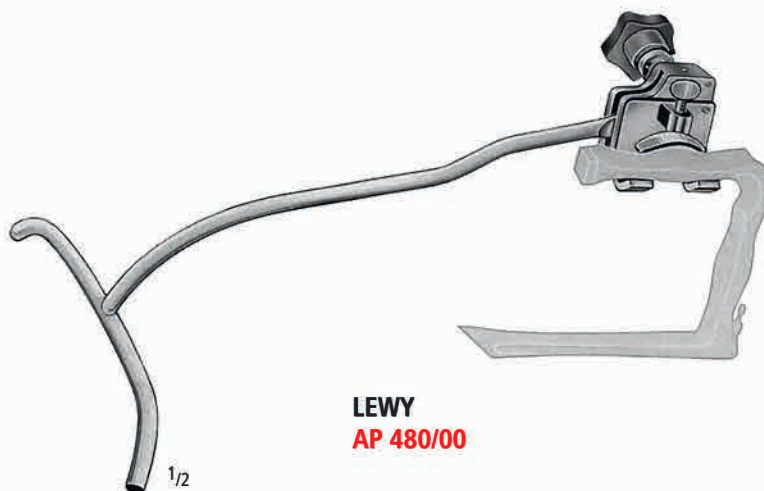

**LEWY**  
**AP 480/00**

Laryngoskophalter mit Bruststütze, komplett  
 Laryngoscope holder with chest support, complete  
 Porta-laryngoscopio con soporte de pecho, completo  
 Porta-laryngoscope avec support de poitrine, complète  
 Porta-laringosopio con supporto sternale, completo



**AP 481/24**  
 24,0 cm/9<sup>1</sup>/<sub>2</sub>"  
 für Kinder  
 for children  
 para niños  
 pour enfants  
 per bambini

**AP 481/34**  
 34,0 cm/13<sup>3</sup>/<sub>8</sub>"  
 für Erwachsene  
 for adults  
 para adultos  
 pour adultes  
 per adulti

AA  
 AB  
 AC  
 AD  
 AE  
 AF  
 AG  
 AH  
 AI  
 AJ  
 AK  
 AL  
 AM  
 AN  
 AO  
 AP  
 AQ  
 AR  
 AS  
 AT  
 AU  
 AV  
 AW  
 AX

Zubehör für Operations-Laryngoskope  
 Accessories for operating laryngoscopes  
 Accesorios para laringoscopios para operaciones  
 Accessoires pour laryngoscopes opératoires  
 Accessori per laringoscopi operatori

Stützstange, allein  
 Support rod, only  
 Soporte barra, sola  
 Barre de support, seule  
 Barra di supporto, sola



**AP 483/24**  
 24,0 cm/9<sup>1</sup>/<sub>2</sub>"  
 für Kinder  
 for children  
 para niños  
 pour enfants  
 per bambini

**AP 483/34**  
 34,0 cm/13<sup>3</sup>/<sub>8</sub>"  
 für Erwachsene  
 for adults  
 para adultos  
 pour adultes  
 per adulti



Gummiring für Stützstange, allein  
 Rubber ring for support rod, only  
 Anillo de goma para soporte barra, solo  
 Anneau de gomme pour barre de support, seul  
 Anello di gomma per barra di supporto, solo

**AP 485/09**  
 Ø 9,5 cm



Laryngoskophalter, allein  
 Laryngoscope holder, only  
 Porta-laringoscopio, solo  
 Porta-laryngoscope, seul  
 Porta-laringoscopio con supporto sternale, solo

**AP 485/10**

Stirnlampen, Stirnspiegel  
 Head Lamps, Head Mirrors  
 Lámparas frontales, Espejos frontales  
 Eclaireurs frontaux, Miroirs frontaux  
 Lampade frontali, Specchi frontali



**AR 090/00**



**ZIEGLER**  
 90 mm = **AR 102/09**  
 100 mm = **AR 102/10**

AA  
 AB  
 AC  
 AD  
 AE  
 AF  
 AK  
 AL  
 AO  
 AP  
**AR**  
 KA  
 KL  
 KM  
 KO  
 KU  
 KYE  
 X

Stirnlampen (Xenon), Kaltlicht-Stirnlampen  
 Head Lamps (Xenon), Fibre Optic Head Lamps  
 Lámparas frontales (Xenon), Lámparas frontales de luz fría  
 Eclairage frontaux (Xenon), Eclairage frontaux à lumière froide  
 Lampade frontali (Xenon), Lampade frontali a luce fredda



**CLAR 55**  
**AR 150/55**  
 Ø 55 mm  
 6 V



**CLAR S**  
**AR 160/00**  
 Ø 98 mm  
 6 V



185 g  
**CLAR LED I**  
**AR 160/50**  
 Ø 55 mm

Stirnspiegel mit LED inkl. Batteriegehäuse (4 x Typ C) / Stirnband: ergonomisch, verstellbar, gepolstert (Schaumstoff)  
 Head mirror with LED incl. battery box (4 x type C) / headband: ergonomic, adjustable, upholstered (foam)  
 Espejo frontal con LED incl. caja para baterías (4 x tipo C) / cinta: ergonómica, ajustable, almohadillada (espuma)  
 Miroir frontal avec DEL incl. boîte pour batteries (4 x type C) / serre-tête: ergonomique, ajustable, rembourré (mousse synthétique)  
 Specchio frontale con LED incl. alloggiamento batteria (4 x tipo C) / benda: ergonomica, regolabile, imbottita (espanso)



Stirnlampen, Stirnspiegel  
 Head Lamps, Head Mirrors  
 Lámparas frontales, Espejos frontales  
 Eclaireurs frontaux, Miroirs frontaux  
 Lampade frontali, Specchi frontali



**XENON**  
**AR 162/00**



**AR 162/01**  
 Ersatzlampe mit Reflektor  
 Spare lamp with reflector  
 Lámpara de repuesto  
 Lampe de rechange  
 Lampada de ricambio

Helle Stirnleuchte mit 6000Cd Hochleistungs-Xenon-Lampe / optimiertes parabolisches optisches System mit festem Focus / integrierte Batteriebox für 2 Mignonzellen (AA)  
 Very bright Xenon Headlight with high power optical system and fix focus / Special miniature Xenon incandescent reflector lamp (6000 candle power) / integrated battery box for 2 AA cells



**AR 165/11**

Lieferung ohne Adapter  
 Delivery without adapter  
 Entrega sin adaptador  
 Livraison sans adaptateur  
 Consegna senza adattatore

Fiberoptische Miniaturstirnleuchte für den OP-Bereich / Miniatur-Hochleistungsoptik / Faserbündel Ø 3,5 mm / heller, homogener Lichtfleck / ledergepolstertes Stirnband mit seitlichen Kopfstützen und Stellrad / mit Kopfbügelstirnband  
 Fibre Optic miniature Headlight for operation theatre / Perfect view by very small optic / The fibre bundle diameter of 3.5 mm and the double lens system effect small and homogenous light spot / With lateral head supports / Easily adjustable by hand wheel / With cross band



360 g

**CLAR FO I**  
**AR 165/21**  
 Ø 33 mm

Lieferung ohne Adapter  
 Delivery without adapter  
 Entrega sin adaptador  
 Livraison sans adaptateur  
 Consegna senza adattatore

Klassischer Kaltlicht-Stirnspiegel für HNO-Anwendungen / Hochleistungsspiegelreflektor / Glasfaserkabel: 2,2 m; Ø 4,0 mm / Kopfband: komfortabel, gepolstert (Leder) / Kopfbügel mit Schnellverstellung  
 Conventional fibre optic head mirror for ENT applications / powerful mirror reflector / fibre optic cable: 2,2 m; Ø 4,0 mm / headband: comfortable, upholstered (leather) / headband with quick adjustment

AA  
 AB  
 AC  
 AD  
 AE  
 AF  
 AK  
 AL  
 AO  
 AP  
 AR  
 KA  
 KL  
 KM  
 KO  
 KU  
 KYE  
 X



Stirnlampen (LED)  
 Head Lamps (LED)  
 Lámparas frontales (LED)  
 Eclaireurs frontaux (DEL)  
 Lampade frontali (LED)

Moderne fokussierbare Fiberoptik-Stirnleuchte mit Hochleistungsoptik / weitem Stellbereich / Hohe Lichtleistung / komfortables Kopfband / Spezialkabel mit Halteclips (Telling im Kopfbereich) für optimalen Tragekomfort  
 Modern focusable Fibre Optic Headlight with high performance optical system / wide focus range and powerful light spot / Light weight and comfortable headband / special cable with grown clips for long time use and highest comfort



**OP COLD 1**  
**AR 165/31**

für allgemeine Chirurgie und HNO, geteiltes, armiertes Spezialkabel, Kopfband mit Top, schwarz  
 for general surgery and ENT, bifurcated, shielded special cable, headband with top, black

Abstand	Leuchtfeld
Distance	Luminous field
Distancia	Campo luminoso
Distance	Champ lumineux
Distanza	Campo luminoso
30 cm	Ø 25-70 mm
6000 K	



150 g  
**POWER LED I**  
**AR 167/00**

Leistungsstarke, fokussierbare Stirnleuchte mit weißer LED inkl. Batteriegehäuse (5 x Typ AA) / Stirnband: ergonomisch, verstellbar, gepolstert (Neopren)  
 Powerful, focusable headlight with white LED incl. battery box (5 x type AA) / headband: ergonomic, adjustable, upholstered (neoprene)  
 Lámpara frontal de alto rendimiento, enfocable con LED blanco incl. caja para baterías (5 x tipo AA) / cinta: ergonómica, ajustable, almohadillada (neopreno)  
 Lampe frontale, très performant, focalisable avec DEL blanche incl. boîte pour batteries (5 x type AA) / serre-tête: ergonomique, ajustable, rembourré (néoprène)  
 Lampada frontale, alto rendimento, regolabile con LED bianco incl. alloggiamento batteria (5 x tipo AA) / benda: ergonomica, regolabile, imbottita (neoprene)

DIAGNOSTIK DIAGNOSTICS DIAGNOSTICO DIAGNOSTIC DIAGNOSTICA

Stirnlampen (LED)  
 Head Lamps (LED)  
 Lámparas frontales (LED)  
 Eclaireurs frontaux (DEL)  
 Lampade frontali (LED)

Abstand	Leuchtfeld
Distance	Luminous field
Distancia	Campo luminoso
Distance	Champ lumineux
Distanza	Campo luminoso

20 cm	Ø 8-35 mm
30 cm	Ø 9-55 mm
60 cm	Ø 18-115 mm

6000 K



230 g

**OP LED I**  
**AR 168/00**

Leistungsstarke, fokussierbare Stirnleuchte mit moderner LED inkl. Li-Akku und Ladegerät / Stirnband: ergonomisch, flexibel, gepolstert (Neopren) / für längere Operationen  
 Powerful, focusable head light with modern LED incl. Li-accumulator and charger / headband: ergonomic, flexible, upholstered (neoprene) / for longer surgeries  
 Lámpara frontal de alto rendimiento, enfocable con LED moderno incl. Li-acumulador y cargador / cinta: ergonómica, flexible, almohadillada (neopreno) / por operaciones largas  
 Lampe frontale, très performant, focalisable avec DEL moderne incl. Li-accumulateur et chargeur / serre-tête: ergonomique, flexible, rembourré (néoprène) / pour opérations longues  
 Lampada frontale, alto rendimento, regolabile con LED moderno incl. Li-accumulatore e caricabatteria / benda: ergonomica, flessibile, imbottita (neoprene) / per operazioni più lunga

Abstand	Leuchtfeld
Distance	Luminous field
Distancia	Campo luminoso
Distance	Champ lumineux
Distanza	Campo luminoso

20 cm	Ø 8-35 mm
30 cm	Ø 9-55 mm
60 cm	Ø 18-115 mm

6000 K



350 g

**AUTO SWITCH**  
**AR 169/00**

Auto-Switch LED-Stirnleuchte mit Ladeständer / Kabellos / Li-Ion Akku / Betriebsdauer ca. 3,5 h  
 Auto Switch LED Headlight with charging stand / Wireless / Li-Ion rechargeable battery pack / Operation time approx. 3,5 h

AA  
 AB  
 AC  
 AD  
 AE  
 AF  
 AK  
 AL  
 AO  
 AP  
 AR  
 KA  
 KL  
 KM  
 KO  
 KU  
 KYE  
 X

Nystagmusbrillen (Halogen)  
Nystagmus Spectacles (Halogen)  
Gafas Nistagmo (Halógeno)  
Lunettes Nystagmus (Halogène)  
Occhiali Nistagmo (Halogeno)

**AR 180/02**

Feste Bikonvexlinsen (+18 Dioptrien) / fester, transversaler Batteriegriff (ohne Batterien) / Lichtstärkenregulierung -  
Fixed biconvex lenses (+18 diopters) / fixed, transversal battery handle (without batteries) / light intensity control -  
Lentes biconvexas, fijas (+18 dioptria) / mango de batería transversal, fijo (sin baterías) / intensidad de la luz regulable -  
Lentilles biconvexes fixes (+18 dioptries) / poignée à batterie fixe, transversal (sans batteries) / intensité lumineuse réglable -  
Lenti biconvesse, fisse (+18,0 diotrie) / manico a batteria fisso, transversal (senza batterie) / intensità luminosa regolabile

**AR 180/03**

Feste Bikonvexlinsen (+18 Dioptrien) / seitlicher, abnehmbarer Batteriegriff (ohne Batterien) mit Bajonettanschluss / Lichtstärkenregulierung -  
Fixed biconvex lenses (+18 diopters) / lateral, detachable battery handle (without batteries) with bayonet connection / light intensity control -  
Lentes biconvexas, fijas (+18 dioptria) / mango de batería lateral, desacoplable (sin baterías) con conexión bayoneta / intensidad de la luz regulable -  
Lentilles biconvexes fixes (+18 dioptries) / poignée à batterie latérale, démontable (sans batteries) avec connexion baionnette / intensité lumineuse réglable -  
Lenti biconvesse, fisse (+18,0 diotrie) / manico a batteria laterale, removibile (senza batterie) con connessione baionetta / intensità luminosa regolabile

**AR 180/11**

Feste Bikonvexlinsen (+18 Dioptrien) / Clip-Kopfband / festes Anschlusskabel 1,4 m / Li-Akku-Steuereinheit und Ladestation / Lichtstärkenregulierung / Timerfunktion -  
Fixed biconvex lenses (+18 diopters) / clip-headband / fixed connection cable 1,4 m / Li-accumulator with control unit and charging station / light intensity control / timer function -  
Lentes biconvexas, fijas (+18 dioptria) / cinta / cable fijo de conexión 1,4 m / Li-acumulador con unidad de control y base de recarga / intensidad de la luz regulable / función de temporizador -  
Lentilles biconvexes fixes (+18 dioptries) / serre-tête / cable de raccordement fixe 1,4 m / Li-accumulateur avec appareil de contrôle y base de chargement / intensité lumineuse réglable / fonction de temporization -  
Lenti biconvesse, fisse (+18,0 diotrie) / benda / cavo di raccordo 1,4 m / Li-accumulatore con unità di controllo y stazione di carico / intensità luminosa regolabile / funzione di timer

Nystagmusbrillen (LED)  
 Nystagmus Spectacles (LED)  
 Gafas Nistagmo (LED)  
 Lunettes Nystagmus (DEL)  
 Occhiali Nistagmo (LED)



**AR 180/12**

Feste Bikonvexlinsen (+18 Dioptrien) / Clip-Kopfband / festes Anschlusskabel 1,4 m / Steuereinheit mit Netzgerät / Lichtstärkenregulierung / Timerfunktion

Fixed biconvex lenses (+18 diopters) / clip-headband / fixed connection cable 1,4 m / control unit with power supply / light intensity control / timer function

Lentes biconvexas, fijas (+18 dioptria) / cinta / cable fijo de conexión 1,4 m /

unidad de control con aparato de alimentación / intensidad de la luz regulable / función de temporizador -

Lentilles biconvexes fixes (+18 dioptries) / serre-tête / cable de raccordement fixe 1,4 m / appareil de contrôle avec bloc d'alimentation / fonction de temporization-

Lenti biconvesse, fisse (+18,0 diotrie) / benda / cavo di raccordo 1,4 m / unità di controllo con alimentatore / intensità luminosa regolabile / funzione di timer

**AR 180/23**

Ersatzlampe  
 Spare bulb  
 Lámpara de repuesto  
 Lampe de rechange  
 Lampada de ricambio



**AR 180/24**

Lampenabdeckung  
 Bulb cover  
 Cobertura para lámpara  
 Cache pour lampe  
 Copertura per lampada



AA  
 AB  
 AC  
 AD  
 AE  
 AF  
 AK  
 AL  
 AO  
 AP  
 AR  
 KA  
 KL  
 KM  
 KO  
 KU  
 KYE  
 X



Facelift-Markierer, Sensibilitäts-Instrumente  
 Facelift marker, Sensibility Instruments  
 Marcador para facelift, Instrumentos sensibilidad  
 Marqueur pour facelift, Instruments sensibilités  
 Marcatore per facelift, Strumenti per sensibilità

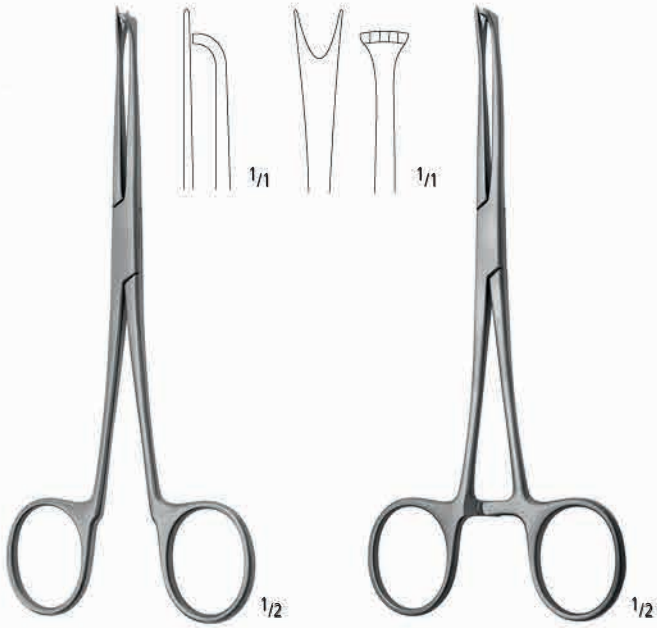

**AR 297/16**  
 16,0 cm/6 1/4"

**AR 298/16**  
 16,0 cm/6 1/4"



**ALY**  
**AR 300/00**  
 19,0 cm/7 1/2"



**WARTENBERG**  
**AR 301/00**



Stethoskope  
Stethoscopes  
Estetoscopios  
Stéthoscopes  
Stetoscopi



**RIRAP**

40,0 cm/16" = **AR 320/40**

80,0 cm/32" = **AR 320/80**

AA  
AB  
AC  
AD  
AE  
AF  
AK  
AL  
AO  
AP  
**AR**  
KA  
KL  
KM  
KO  
KU  
KYE  
X

Stethoskope  
Stethoscopes  
Estetoscopios  
Stéthoscopes  
Stetoscopi



**CARDIOPHON**  
**AR 321/00**



**DUPLEX**  
**AR 322/00**

Blutdruckmesser  
Blood Pressure Manometers  
Manómetro para la presión de la sangre  
Tensiomètre à mercure  
Sfigmomanometro a mercurio



**PRECISA**  
**AR 352/00**

AA

AB

AC

AD

AE

AF

AK

AL

AO

AP

AR

KA

KL

KM

KO

KU

KYE

X

Diagnostik-Bestecke  
Diagnostic Sets  
Juegos para diagnóstico  
Trousses à diagnostic  
Astucci per diagnostica



**UNI-ECONOM**  
**AR 400/00**

Diagnostik-Bestecke  
 Diagnostic Sets  
 Juegos para diagnóstico  
 Trousses à diagnostic  
 Astucci per diagnostica



**OTO - / OPHTHALMOSKOP**  
**AR 402/00**



**OTOSKOP UNI**  
**AR 410/00**

AA  
 AB  
 AC  
 AD  
 AE  
 AF  
 AK  
 AL  
 AO  
 AP  
**AR**  
 KA  
 KL  
 KM  
 KO  
 KU  
 KYE  
 X



## USB Video Otokop



### USB VIDEO OTOSKOP ORLVISION OX1 AR 415/00

#### Technical Specification Video Otokop OX1

Model	OX1
Direction of View (DOV)	0°
Field of View (FOV)	60°
Depth of Focus (DOF)	5 - 50 mm
Diameter Ø	4,0 mm
Ear Funnel, Disposable	2,0 mm und 4,0 mm
Illumination	High Power Whitelight LED
Video System	NTSC
Interface	USB 2.0 and Composite Video (Cinch)
Power Supply	5V Medical AC-Adapter or USB 2.0
Dimensions, Handpiece	130 mm x 40 mm x 40 mm / 60 Gramm
Dimensions, Hub	170 mm x 70 mm x 130 mm / 400 Gramm
Supply Cable, Hub to USB	1800 mm
Supply Cable, Hub to Handpiece	1800 mm
Medical Classification	Class 1
Protection Class	IP 65

ORTHOPÄDIE  
ORTHOPAEDIC  
ORTOPEDIA  
ORTHOPEDIE  
ORTOPEDIA

KA

nopa<sup>®</sup> instruments

Weitere Orthopädie-Instrumente finden Sie in unserem Orthopädie-Programm.

For further orthopaedic instruments, kindly refer to our orthopedics assortment.

Para instrumentos de ortopedia adicionales, por favor consulte nuestro programa de ortopedia.

Pour des instruments d'orthopédie supplémentaires, consultez notre gamme d'orthopédie.

Per gli altri strumenti ortopedici, consultare il nostro assortimento de la ortopedia.



Maßtabelle  
 Scale  
 Tabla de medida  
 Tableau de la mesure  
 Scala

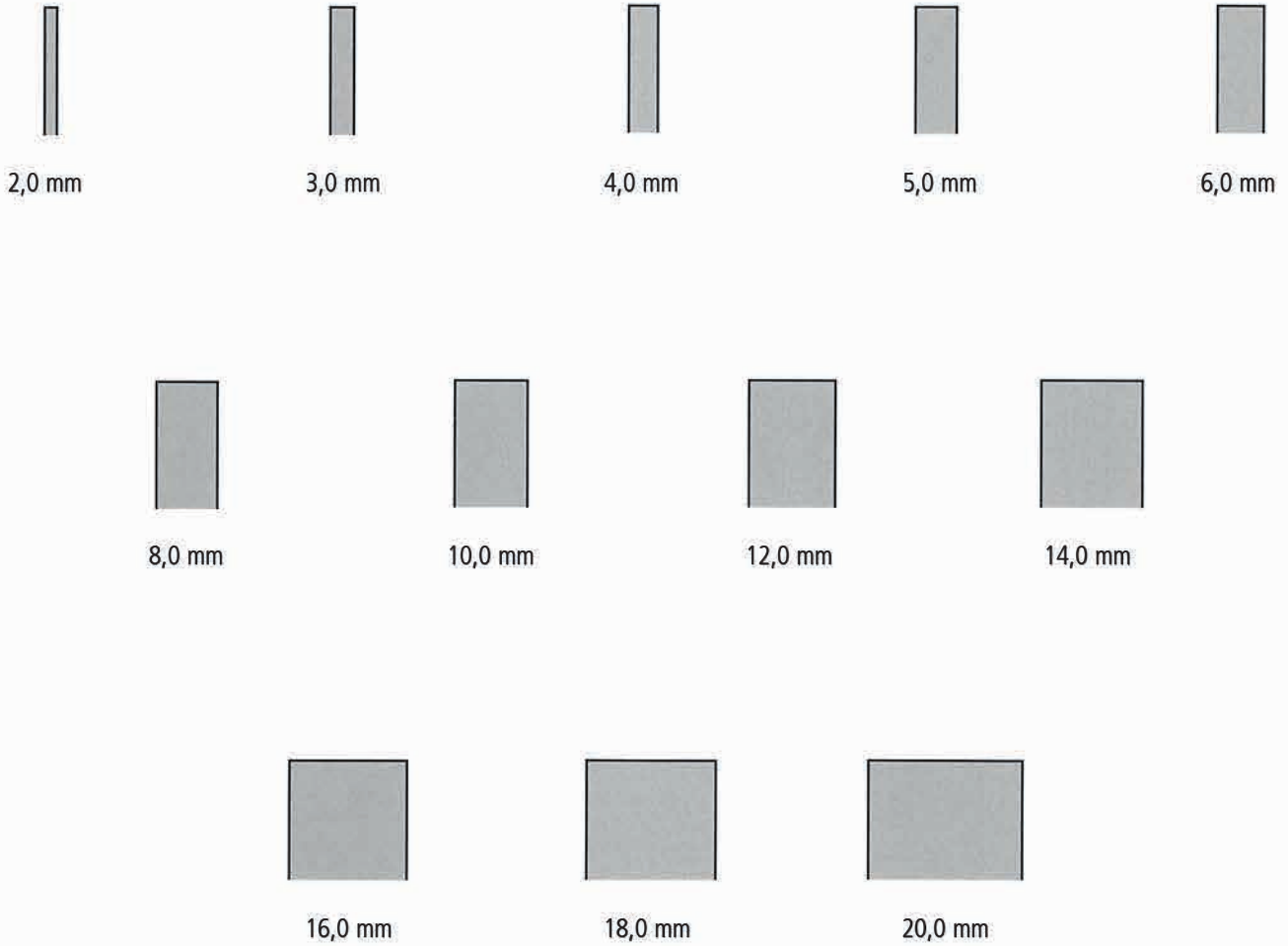

Weitere Größen finden Sie in unserem Orthopädie-Programm.  
 For further sizes kindly refer to our orthopaedics assortment.

ORTHOPÄDIE ORTHOPAEDIC ORTOPEDIA ORTHOPEDIE ORTOPEDIA

Meißel und Osteotome  
 Chisels, Gouges and Osteotomes  
 Cinceles y Gubias  
 Ciseaux-Burins et Ostéotomes  
 Scalpelli, Osteotomi, Sgorbie



1/2

mm 13,5 cm/5 1/4"

- 8,0 KA 400/08
- 10,0 KA 400/10
- 12,0 KA 400/12
- 14,0 KA 400/14
- 16,0 KA 400/16



1/2

mm 13,5 cm/5 1/4"

- KA 401/08
- KA 401/10
- KA 401/12
- KA 401/14
- KA 401/16



1/2

mm 13,5 cm/5 1/4"

- KA 402/08
- KA 402/10
- KA 402/12
- KA 402/14
- KA 402/16



1/2

mm HOKE 14,0 cm/5 1/2"

- 3,0 KA 404/03
- 5,0 KA 404/05
- 6,0 KA 404/06
- 8,0 KA 404/08
- 9,0 KA 404/09



1/2

mm LUCAS 16,0 cm/6 1/4"

- 4,0 KA 406/04
- 6,0 KA 406/06



1/2

mm LUCAS 16,0 cm/6 1/4"

- 3,0 KA 407/03
- 5,0 KA 407/05

AA  
AB  
AC  
AD  
AE  
AF  
AK  
AL  
AO  
AP  
AR  
KA  
KL  
KM  
KO  
KU  
KYE  
X

Meißel und Osteotome  
 Chisels, Gouges and Osteotomes  
 Cinceles y Gubias  
 Ciseaux-Burins et Ostéotomes  
 Scalpelli, Osteotomi, Sgorbie



	<b>ALEXANDER</b>
	18,0 cm/7"
mm	
4,0	<b>KA 418/04</b>
6,0	<b>KA 418/06</b>
8,0	<b>KA 418/08</b>
10,0	<b>KA 418/10</b>
12,0	<b>KA 418/12</b>
14,0	<b>KA 418/14</b>

	<b>ALEXANDER</b>
	18,0 cm/7"
mm	
4,0	<b>KA 419/04</b>
6,0	<b>KA 419/06</b>
8,0	<b>KA 419/08</b>
10,0	<b>KA 419/10</b>
12,0	<b>KA 419/12</b>
14,0	<b>KA 419/14</b>



13,5 cm/5 <sup>1</sup> / <sub>4</sub> "	17,0 cm/6 <sup>3</sup> / <sub>4</sub> "
<b>KA 433/02</b>	<b>KA 437/02</b>
<b>KA 433/03</b>	<b>KA 437/03</b>
<b>KA 433/04</b>	<b>KA 437/04</b>
<b>KA 433/05</b>	<b>KA 437/05</b>
<b>KA 433/06</b>	<b>KA 437/06</b>
<b>KA 433/07</b>	<b>KA 437/07</b>
<b>KA 433/08</b>	<b>KA 437/08</b>

**PARTSCH**

mm	13,5 cm/5 <sup>1</sup> / <sub>4</sub> "	17,0 cm/6 <sup>3</sup> / <sub>4</sub> "
2,0	<b>KA 443/02</b>	<b>KA 447/02</b>
3,0	<b>KA 443/03</b>	<b>KA 447/03</b>
4,0	<b>KA 443/04</b>	<b>KA 447/04</b>
5,0	<b>KA 443/05</b>	<b>KA 447/05</b>
6,0	<b>KA 443/06</b>	<b>KA 447/06</b>
7,0	<b>KA 443/07</b>	<b>KA 447/07</b>
8,0	<b>KA 443/08</b>	<b>KA 447/08</b>



Meißel und Osteotome  
 Chisels, Gouges and Osteotomes  
 Cinceles y Gubias  
 Ciseaux-Burins et Ostéotomes  
 Scalpelli, Osteotomi, Sgorbie



**SMITH-PETERSEN**  
 20,0 cm/8"

mm	<b>KA 450/06</b>	<b>KA 451/06</b>	<b>KA 452/09</b>	<b>KA 453/09</b>
6,0	<b>KA 450/09</b>	<b>KA 451/09</b>		
9,0	<b>KA 450/13</b>	<b>KA 451/13</b>		
13,0			<b>KA 452/14</b>	<b>KA 453/14</b>
14,0				
16,0	<b>KA 450/16</b>	<b>KA 451/16</b>	<b>KA 452/19</b>	<b>KA 453/19</b>
19,0	<b>KA 450/19</b>	<b>KA 451/19</b>		

AA  
 AB  
 AC  
 AD  
 AE  
 AF  
 AK  
 AL  
 AO  
 AP  
 AR  
**KA**  
 KL  
 KM  
 KO  
 KU  
 KYE  
 X

Meißel und Osteotome  
 Chisels, Gouges and Osteotomes  
 Cinceles y Gubias  
 Ciseaux-Burins et Ostéotomes  
 Scalpelli, Osteotomi, Sgorbie

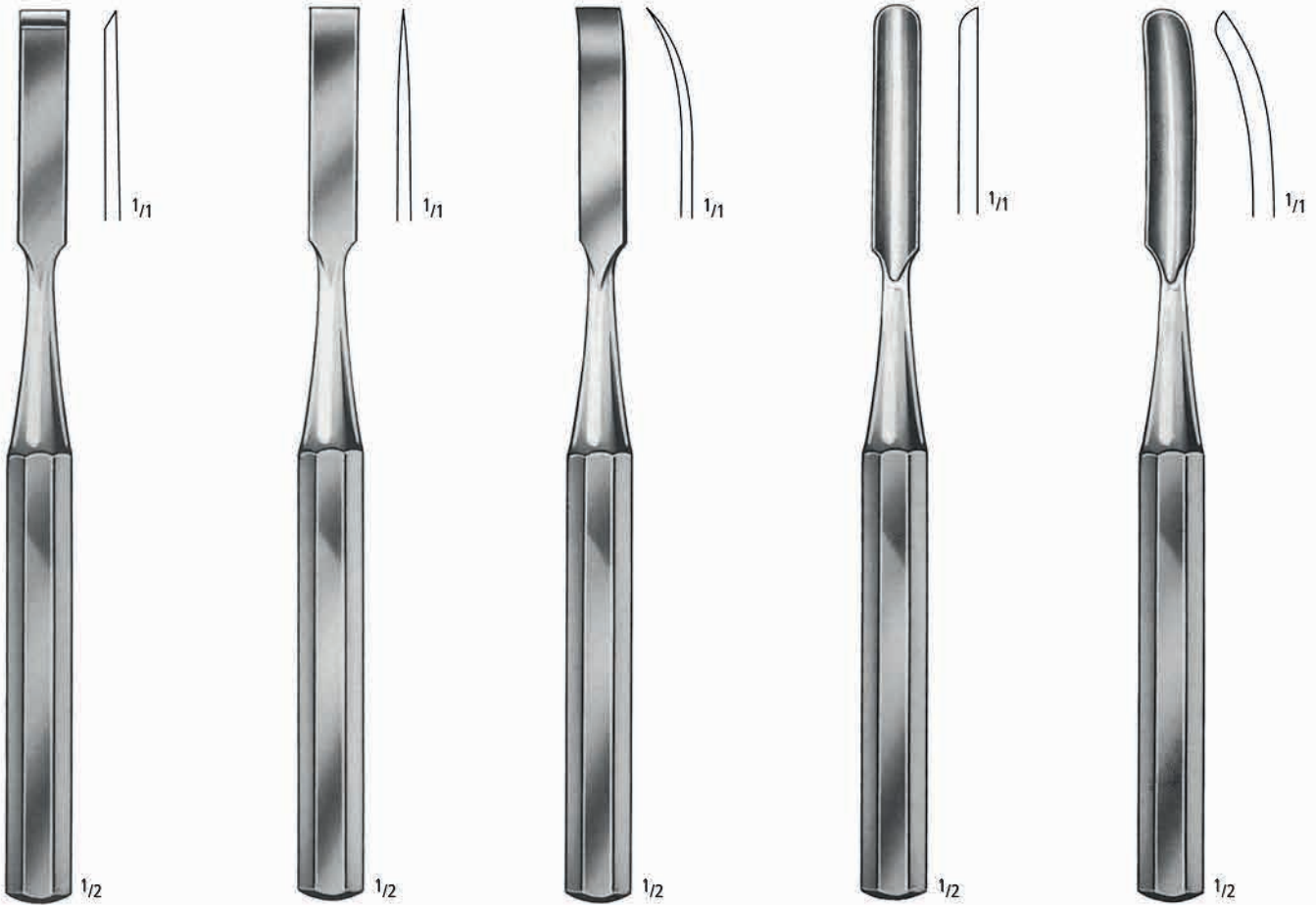

**HIBBS**  
 24,0 cm/9 1/2"

mm  
 6,0 **KA 455/06**  
 13,0 **KA 455/13**

**KA 456/06**  
**KA 456/13**

**KA 457/06**  
**KA 457/13**

**KA 458/06**  
**KA 458/13**

**KA 459/06**  
**KA 459/13**

Meißel und Osteotome  
 Chisels, Gouges and Osteotomes  
 Cinceles y Gubias  
 Ciseaux-Burins et Ostéotomes  
 Scalpelli, Osteotomi, Sgorbie

AA  
AB  
AC  
AD  
AE  
AF  
AK  
AL  
AO  
AP  
AR  
**KA**  
KL  
KM  
KO  
KU  
KYE  
X



**STILLE**  
 20,0 cm/8"

mm  
 8,0 **KA 460/08**  
 10,0 **KA 460/10**  
 15,0 **KA 460/15**

**KA 461/08**  
**KA 461/10**  
**KA 461/15**

**KA 462/08**  
**KA 462/10**  
**KA 462/15**

**KA 463/08**  
**KA 463/10**  
**KA 463/15**

Meißel und Osteotome  
 Chisels, Gouges and Osteotomes  
 Cinceles y Gubias  
 Ciseaux-Burins et Ostéotomes  
 Scalpelli, Osteotomi, Sgorbie



**MINI-LEXER**  
 18,0 cm/7"



**MINI-LEXER**  
 18,0 cm/7"



**LEXER**  
 22,0 cm/8<sup>3</sup>/<sub>4</sub>"



**LEXER**  
 22,0 cm/8<sup>3</sup>/<sub>4</sub>"

mm  
 4,0  
 6,0  
 7,0  
 8,0  
 10,0  
 12,0  
 15,0

**KA 470/04**  
**KA 470/06**  
**KA 470/08**  
**KA 470/10**  
**KA 470/12**  
**KA 470/15**

**KA 471/04**  
**KA 471/06**  
**KA 471/08**  
**KA 471/10**  
**KA 471/12**  
**KA 471/15**

**KA 472/07**  
**KA 472/10**  
**KA 472/15**

**KA 473/07**  
**KA 473/10**  
**KA 473/15**

Ferrozellgriff  
 Hartpress-Handle  
 Mango en "Ferrozell"  
 Manche en "Ferrozell"  
 Manico in "Ferrozell"

Meißel und Osteotome  
 Chisels, Gouges and Osteotomes  
 Cinceles y Gubias  
 Ciseaux-Burins et Ostéotomes  
 Scalpelli, Osteotomi, Sgorbie



**LEXER**  
 27,5 cm/10<sup>3</sup>/<sub>4</sub>"

- mm
- 5,0
- 10,0 **KA 474/10**
- 15,0 **KA 474/15**



**LEXER**  
 27,5 cm/10<sup>3</sup>/<sub>4</sub>"

- KA 475/10**
- KA 475/15**



**LEXER**  
 25,0 cm/10"

- KA 476/05**
- KA 476/10**
- KA 476/15**



**LEXER**  
 25,0 cm/10"

- KA 477/05**
- KA 477/10**
- KA 477/15**

Ferrozellgriff  
 Hartpress-Handle  
 Mango en "Ferrozell"  
 Manche en "Ferrozell"  
 Manico in "Ferrozell"

AA  
 AB  
 AC  
 AD  
 AE  
 AF  
 AK  
 AL  
 AO  
 AP  
 AR  
**KA**  
 KL  
 KM  
 KO  
 KU  
 KYE  
 X



Meißel und Osteotome  
 Chisels, Gouges and Osteotomes  
 Cinceles y Gubias  
 Ciseaux-Burins et Ostéotomes  
 Scalpelli, Osteotomi, Sgorbie



**COBB**  
 28,0 cm/11"

**KA 478/01**



**COBB**  
 28,0 cm/11"

**KA 478/02**



**COBB**  
 28,0 cm/11"

**KA 478/03**



**COBB**  
 28,0 cm/11"







**KA 478/04**

Meißel und Osteotome  
 Chisels, Gouges and Osteotomes  
 Cinceles y Gubias  
 Ciseaux-Burins et Ostéotomes  
 Scalpelli, Osteotomi, Sgorbie



**DAHMEN**  
 30,0 cm/12"

Ferrozellgriff  
 Hartpress-Handle  
 Mango en "Ferrozell"  
 Manche en "Ferrozell"  
 Manico in "Ferrozell"

	<b>KA 479/01</b>	<b>KA 479/02</b>	<b>KA 479/03</b>	<b>KA 479/04</b>
	<b>KA 479/05</b>	<b>KA 479/06</b>	<b>KA 479/07</b>	<b>KA 479/08</b>
	<b>KA 479/09</b>	<b>KA 479/10</b>	<b>KA 479/11</b>	<b>KA 479/12</b>
	<b>KA 479/13</b>	<b>KA 479/14</b>	<b>KA 479/15</b>	<b>KA 479/16</b>
	<b>KA 479/17</b>	<b>KA 479/18</b>	<b>KA 479/19</b>	<b>KA 479/20</b>
	<b>KA 479/21</b>	<b>KA 479/22</b>	<b>KA 479/23</b>	<b>KA 479/24</b>
	<b>KA 479/25</b>	<b>KA 479/26</b>	<b>KA 479/27</b>	<b>KA 479/28</b>

AA  
AB  
AC  
AD  
AE  
AF  
AK  
AL  
AO  
AP  
AR  
KA  
KL  
KM  
KO  
KU  
KYE  
X

Meißel und Osteotome  
 Chisels, Gouges and Osteotomes  
 Cinceles y Gubias  
 Ciseaux-Burins et Ostéotomes  
 Scalpelli, Osteotomi, Sgorbie

Weitere Meißel und Osteotome siehe Gruppe KO  
 Further Chisels, Gouges and Osteotomes see section KO  
 Otras tijeras Cinceles y Gubias ver seccion KO  
 D'autres Ciseaux-Burins et Ostéotomes voir groupe KO  
 Altre Scalpelli, Osteotomi, Sgorbie vedi gruppo KO



**MINI-LAMBOTTE**  
 12,5 cm/5"

- mm
- 3,0 **KA 480/03**
- 4,0 **KA 480/04**
- 6,0 **KA 480/06**
- 8,0 **KA 480/08**
- 10,0 **KA 480/10**
- 12,0 **KA 480/12**
- 15,0 **KA 480/15**

**MINI-LAMBOTTE**  
 17,0 cm/6<sup>3</sup>/<sub>4</sub>"

- KA 481/03**
- KA 481/04**
- KA 481/06**
- KA 481/08**
- KA 481/10**
- KA 481/12**
- KA 481/15**



**LAMBOTTE**  
 24,0 cm/9<sup>1</sup>/<sub>2</sub>"

- mm
- 15,0 **KA 482/15**



**LAMBOTTE**  
 23,0 cm/9"

- KA 483/15**

Hämmer  
Mallets  
Martillos  
Marteaux  
Martelli



**KA 520/30**  
Ø 26 mm  
300 g (10<sup>3</sup>/<sub>4</sub> oz.)

**KA 520/34**  
Ø 28 mm  
340 g (12 oz.)

**KA 520/40**  
Ø 30 mm  
400 g (14<sup>1</sup>/<sub>4</sub> oz.)

**WILLIGER**  
24,0 cm/9<sup>1</sup>/<sub>2</sub>"



**COTTLE**  
**KA 531/24**  
19,0 cm/7<sup>1</sup>/<sub>2</sub>"  
240 g (8<sup>1</sup>/<sub>2</sub> oz.)



**COLLIN**  
**KA 532/22**  
20,0 cm/8"

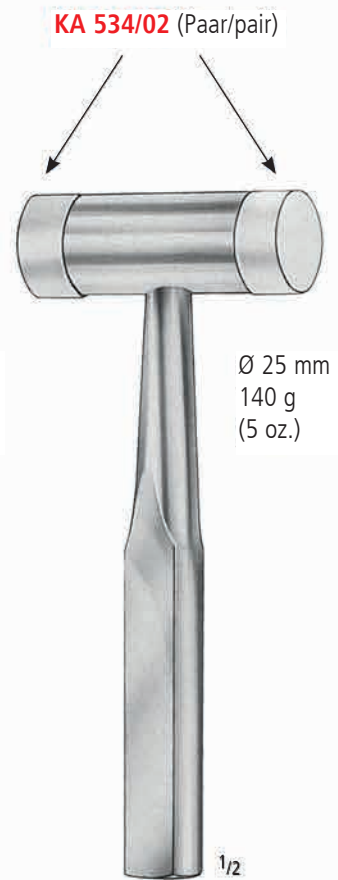

**KA 534/02** (Paar/pair)

Ø 30 mm  
220 g (7<sup>3</sup>/<sub>4</sub> oz.)

Ø 25 mm  
140 g  
(5 oz.)

**KA 534/14**  
18,0 cm/7"

AA  
AB  
AC  
AD  
AE  
AF  
AK  
AL  
AO  
AP  
AR  
KA  
KL  
KM  
KO  
KU  
KYE  
X

Hämmer  
Mallets  
Martillos  
Marteaux  
Martelli

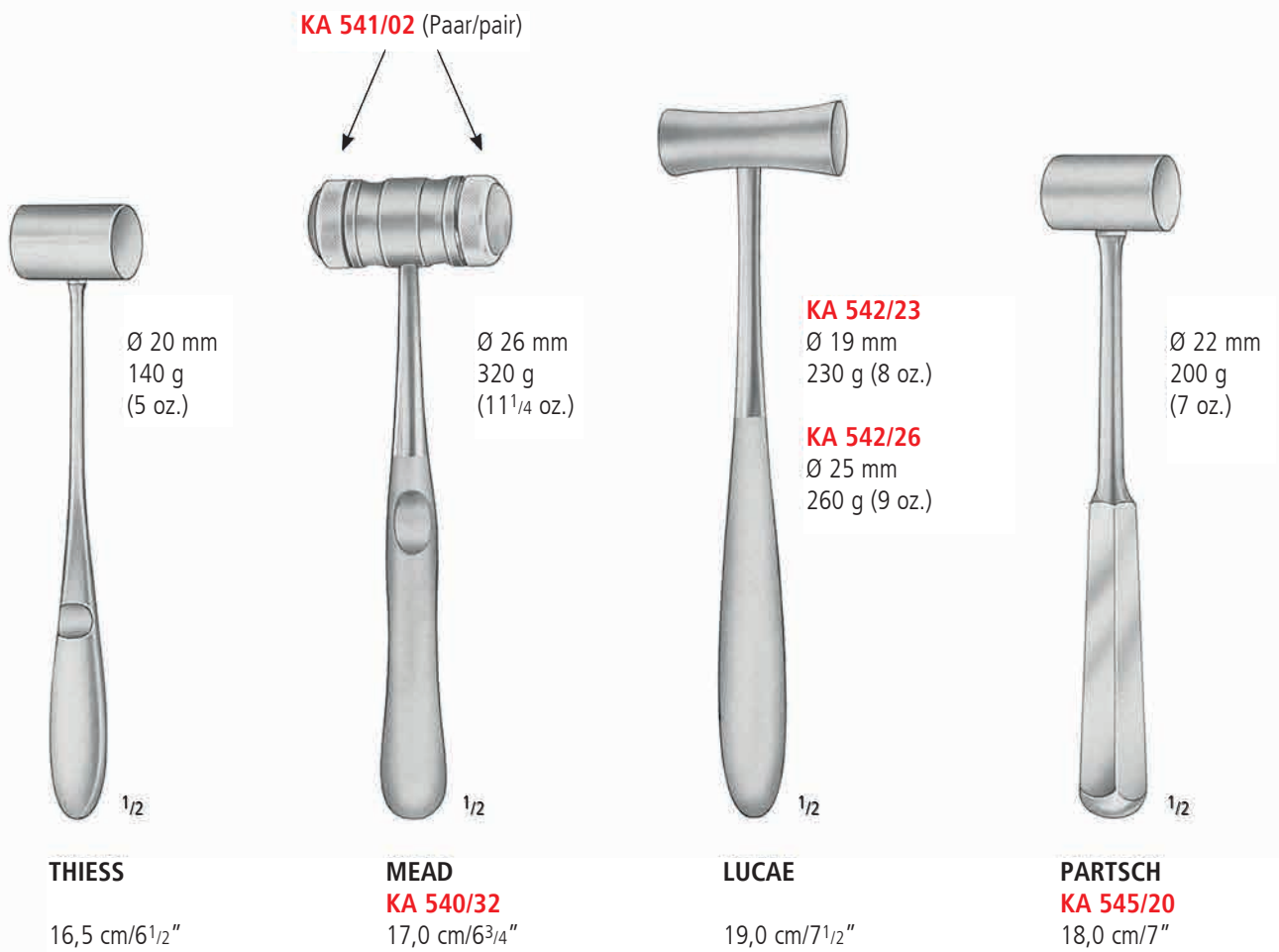

**KA 535/16**

bleigefüllt  
lead filled  
relleno de plomo  
garni de plomb  
guarnito di piombo

**KA 536/16**

Messing, massiv  
brass, solid  
latón, macizo  
laiton, solide  
ottone, solido



Hämmer  
Mallets  
Martillos  
Marteaux  
Martelli



**KA 554/90**



**KA 554/37**  
370 g (12<sup>3</sup>/<sub>4</sub> oz.)  
Ferrozell



**KA 555/13**  
125 g (4<sup>1</sup>/<sub>4</sub> oz.)  
Ferrozell



Ø 25,0 mm  
320 g

mit auswechselbaren Backen  
with interchangeable discs  
con tapas intercambiables  
avec plaques interchangeables  
con placche intercambiabili

**KA 556/32**  
18,0 cm/7"

**KA 556/99**  
Nylonbacken allein, paarweise  
Nylon Faces only, pair  
Tapas de Nylon sueltas, par  
Plaques en Nylon seules, paire  
Placche in Nylon sole, a paia

AA  
AB  
AC  
AD  
AE  
AF  
AK  
AL  
AO  
AP  
AR  
KA  
KL  
KM  
KO  
KU  
KYE  
X

Scharfe Löffel  
 Bone Currettes  
 Cucharillas cortantes  
 Curettes tranchantes  
 Curette taglienti



Fig. 0000  
**KA 600/00**



Fig. 000  
**KA 601/00**



Fig. 00  
**KA 602/00**



Fig. 0  
**KA 603/00**



Fig. 1  
**KA 603/01**



Fig. 2  
**KA 603/02**



Fig. 3  
**KA 603/03**



Fig. 4  
**KA 603/04**



Fig. 5  
**KA 603/05**



Fig. 6  
**KA 603/06**



Fig. 000  
**KA 610/00**



Fig. 00  
**KA 611/00**



Fig. 0  
**KA 612/00**



Fig. 1  
**KA 612/01**



Fig. 2  
**KA 612/02**



Fig. 3  
**KA 612/03**



Fig. 4  
**KA 612/04**



Fig. 5  
**KA 612/05**



Fig. 6  
**KA 612/06**



**VOLKMANN**  
 17,0 cm/6<sup>3</sup>/<sub>4</sub>"



**BRUNS**  
 17,0 cm/6<sup>3</sup>/<sub>4</sub>"

Scharfe Löffel  
 Bone Curettes  
 Cucharillas cortantes  
 Curettes tranchantes  
 Curette taglienti

AA  
 AB  
 AC  
 AD  
 AE  
 AF  
 AK  
 AL  
 AO  
 AP  
 AR  
 KA  
 KL  
 KM  
 KO  
 KU  
 KYE  
 X



**SPRATT**  
 17,0 cm/6<sup>3</sup>/<sub>4</sub>"



Fig. 000  
**KA 615/00**



Fig. 00  
**KA 616/00**



Fig. 0  
**KA 617/00**



Fig. 1  
**KA 617/01**



Fig. 2  
**KA 617/02**



Fig. 3  
**KA 617/03**



Fig. 4  
**KA 617/04**



Fig. 5  
**KA 617/05**



**SCHUDE**  
 17,0 cm/6<sup>3</sup>/<sub>4</sub>"



Fig. 000  
**KA 620/00**



Fig. 00  
**KA 621/00**



Fig. 0  
**KA 622/00**



Fig. 1  
**KA 622/01**



Fig. 2  
**KA 622/02**



Fig. 3  
**KA 622/03**



Fig. 4  
**KA 622/04**

Scharfe Löffel  
 Bone Currettes  
 Cucharillas cortantes  
 Currettes tranchantes  
 Curette taglienti



2 mm  
**KA 623/02**



3 mm  
**KA 623/03**



4 mm  
**KA 623/04**



5 mm  
**KA 623/05**



6 mm  
**KA 623/06**



3 mm  
**KA 623/13**



4 mm  
**KA 623/14**



5 mm  
**KA 623/15**



6 mm  
**KA 623/16**



**FOX**



**PIFFARD**



4 mm  
**KA 624/01**



5 mm  
**KA 624/02**



6 mm  
**KA 624/03**

Scharfe Löffel  
 Bone Curettes  
 Cucharillas cortantes  
 Curettes tranchantes  
 Curette taglienti



**BRUNS**  
 23,0 cm/9"

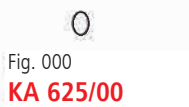

Fig. 000  
**KA 625/00**



Fig. 00  
**KA 625/01**



Fig. 0  
**KA 625/02**

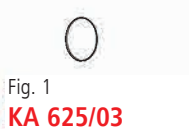

Fig. 1  
**KA 625/03**



Fig. 2  
**KA 625/04**



Fig. 3  
**KA 625/05**



Fig. 4  
**KA 625/06**



Fig. 5  
**KA 625/07**

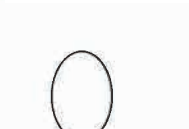

Fig. 6  
**KA 625/08**



**CLOWARD  
 HIBBS SPRATT  
 SPINAL FUSION**  
 22,5 cm/9"

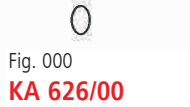

Fig. 000  
**KA 626/00**



Fig. 00  
**KA 627/00**



Fig. 0  
**KA 628/00**



Fig. 1  
**KA 628/01**



Fig. 2  
**KA 628/02**



Fig. 3  
**KA 628/03**



Fig. 4  
**KA 628/04**

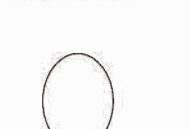

Fig. 5  
**KA 628/05**

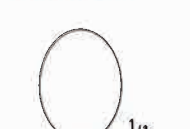

Fig. 6  
**KA 628/06**



**CLOWARD  
 HIBBS SPRATT  
 SPINAL FUSION**  
 22,5 cm/9"



Fig. 000  
**KA 629/00**



Fig. 00  
**KA 630/00**



Fig. 0  
**KA 631/00**



Fig. 1  
**KA 631/01**



Fig. 2  
**KA 631/02**

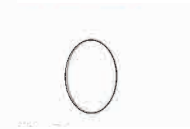

Fig. 3  
**KA 631/03**



Fig. 4  
**KA 631/04**

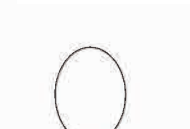

Fig. 5  
**KA 631/05**



Fig. 6  
**KA 631/06**

AA  
 AB  
 AC  
 AD  
 AE  
 AF  
 AK  
 AL  
 AO  
 AP  
 AR  
 KA  
 KL  
 KM  
 KO  
 KU  
 KYE  
 X



Scharfe Löffel  
 Bone Currettes  
 Cucharillas cortantes  
 Curettes tranchantes  
 Curette taglienti



**KA 640/00**

**KA 640/01**

**KA 640/12**

**WILLIGER**  
 13,5 cm/5<sup>1</sup>/<sub>4</sub>"



**KA 642/00**

**KA 642/01**

**KA 642/12**

**MARTINI**  
 13,5 cm/5<sup>1</sup>/<sub>4</sub>"



**JANSEN**  
**KA 644/16**  
 16,0 cm/6<sup>1</sup>/<sub>4</sub>"



**JANSEN**  
**KA 645/15**  
 15,0 cm/6"



**KA 648/21**  
 21,0 cm/8<sup>1</sup>/<sub>4</sub>"



**KA 650/13**  
 13,0 cm/5"

**KA 650/14**  
 14,0 cm/5<sup>1</sup>/<sub>2</sub>"

**VOLKMANN** **KA 650/17**  
 17,0 cm/6<sup>3</sup>/<sub>4</sub>"

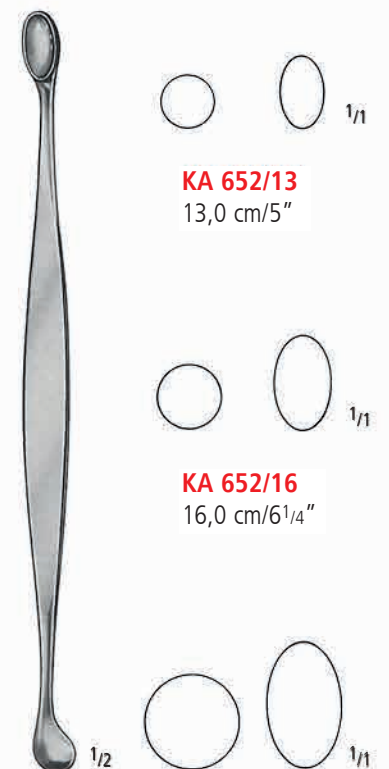

**KA 652/13**  
 13,0 cm/5"

**KA 652/16**  
 16,0 cm/6<sup>1</sup>/<sub>4</sub>"

**VOLKMANN** **KA 652/20**  
 20,0 cm/8"

Raspatorien  
Raspatorios  
Raspadores  
Rugines-Raspatoirs  
Periostotomi



**KA 665/18**  
18,0 cm/7"



**KA 666/18**  
18,0 cm/7"



**KA 667/18**  
18,0 cm/7"



**KA 668/18**  
18,0 cm/7"

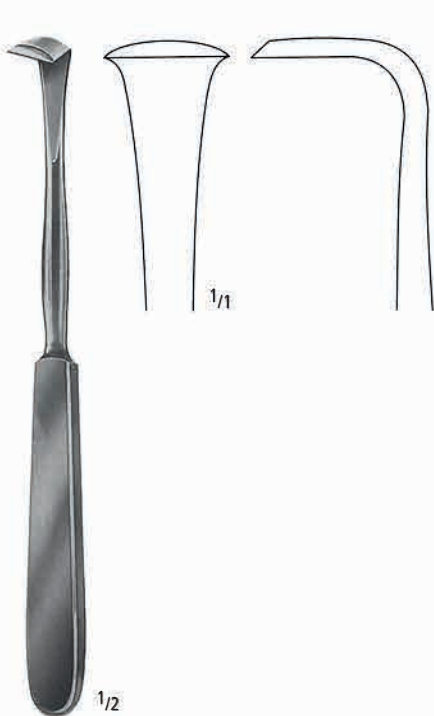

**LANGENBECK**  
**KA 671/18**  
18,0 cm/7"



**LANGENBECK**  
**KA 672/19**  
19,0 cm/7 1/2"

15 mm  
**KA 673/15**

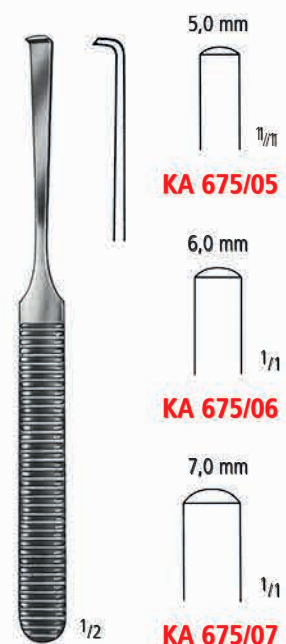

**KA 675/05**

6,0 mm  
**KA 675/06**

7,0 mm  
**KA 675/07**

16,0 cm/6 1/4"

AA  
AB  
AC  
AD  
AE  
AF  
AK  
AL  
AO  
AP  
AR  
KA  
KL  
KM  
KO  
KU  
KYE  
X

Raspatorien, Elevatorien  
 Raspatories, Elevators  
 Raspadores, Elevadores  
 Rugines-Raspatoires, Elévateurs  
 Periostotomi, Elevatori

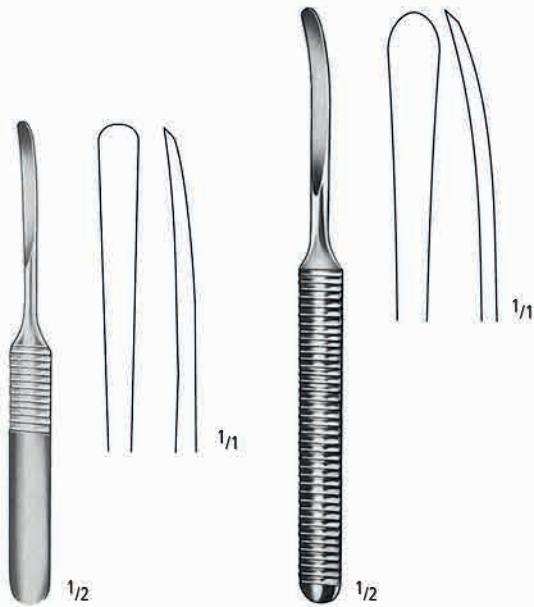

**WILLIGER**  
**KA 680/13**  
 13,0 cm/5"

**WILLIGER**  
**KA 680/16**  
 16,0 cm/6<sup>1</sup>/<sub>4</sub>"



**KA 690/06**

**KA 690/08**

**KA 690/10**

**LANGENBECK**  
 19,5 cm/7<sup>3</sup>/<sub>4</sub>"



**WILLIGER**  
**KA 692/16**  
 16,0 cm/6<sup>1</sup>/<sub>4</sub>"



**WILLIGER**  
**KA 694/17**  
 17,0 cm/6<sup>3</sup>/<sub>4</sub>"

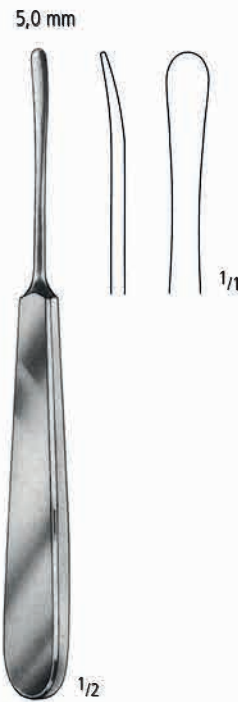

**SEBILEAU**  
**KA 695/05**  
 17,5 cm/7"

Elevatori  
Elevators  
Elevadores  
Elévateurs  
Elevatori



**KA 696/17**  
17,5 cm/6<sup>3</sup>/<sub>4</sub>"



**KA 698/16**  
16,0 cm/6<sup>1</sup>/<sub>4</sub>"



**ALDERDYCE**  
**KA 699/21**  
21,0 cm/8<sup>1</sup>/<sub>4</sub>"



**McDONALD**  
**KA 700/19**  
19,0 cm/7<sup>1</sup>/<sub>2</sub>"



**KA 701/19**  
scharf  
sharp  
cortante  
tranchant  
tagliente

**KA 702/19**  
stumpf  
blunt  
romo  
mousse  
smusso

**FREER**  
19,0 cm/7<sup>1</sup>/<sub>2</sub>"



**FREER**  
**KA 703/18**  
18,0 cm/7"



**HOEN**



**KA 704/07**  
18,0 cm/7"

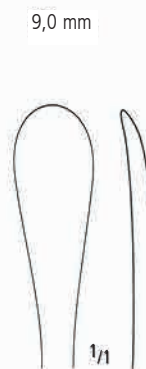

**KA 704/09**  
18,0 cm/7"

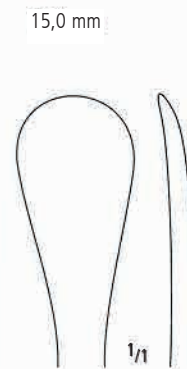

**KA 704/15**  
19,0 cm/7<sup>1</sup>/<sub>2</sub>"

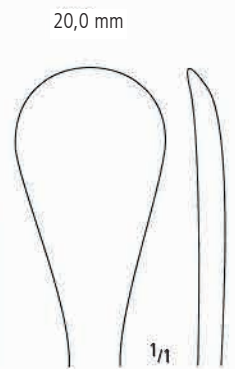

**KA 704/20**  
19,0 cm/7<sup>1</sup>/<sub>2</sub>"

AA  
AB  
AC  
AD  
AE  
AF  
AK  
AL  
AO  
AP  
AR  
**KA**  
KL  
KM  
KO  
KU  
KYE  
X

Face-Lift Dissektoren  
 Face-Lift Dissectors  
 Face-Lift Disectores  
 Face-Lift Dissecteurs  
 Face-Lift Dissettori

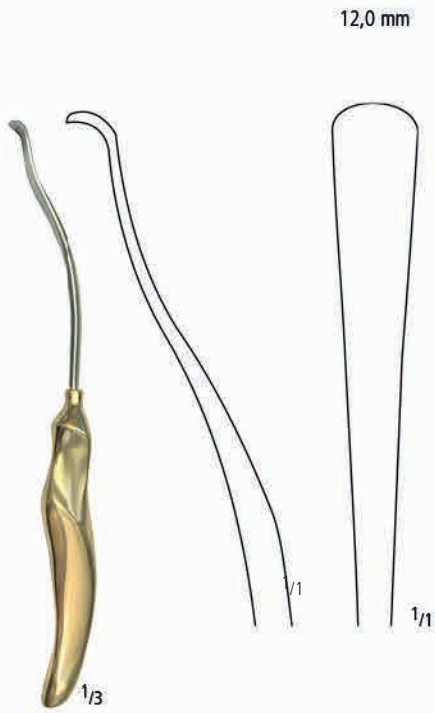

**KA 709/01**  
 23,0 cm/9 1/8"

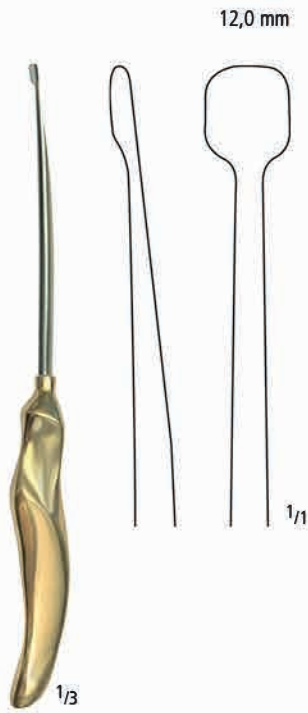

**KA 709/02**  
 25,0 cm/9 3/4"

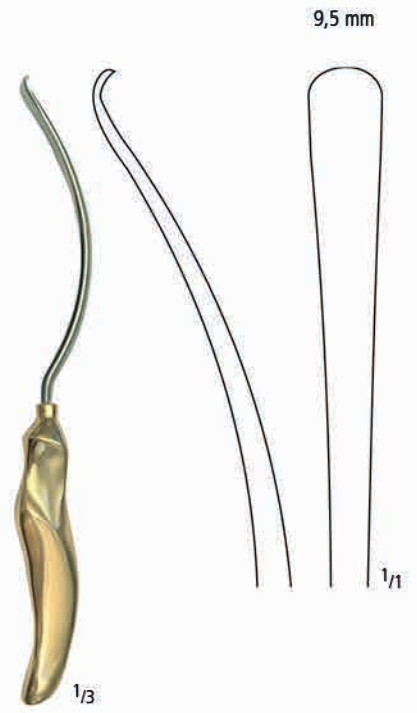

**KA 709/03**  
 26,0 cm/10 1/4"

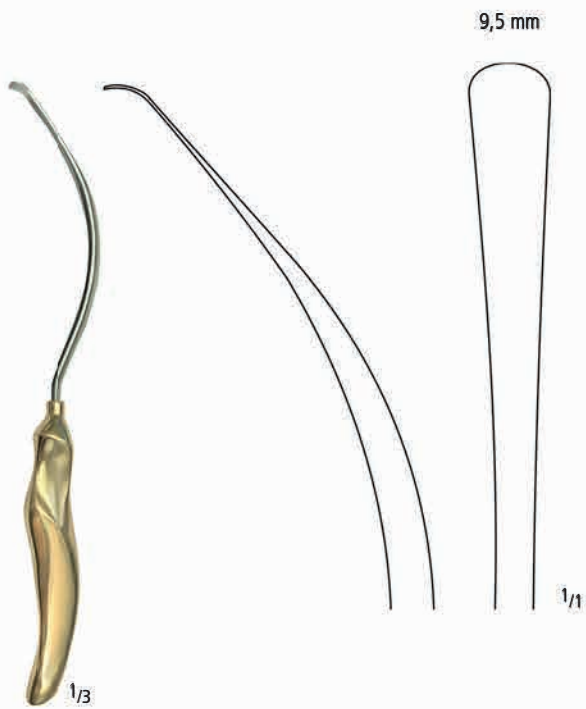

**KA 709/04**  
 25,3 cm/10"



**KA 709/05**  
 25,0 cm/9 3/4"



**KA 709/06**  
 24,0 cm/9 1/2"



Face-Lift Dissektoren  
 Face-Lift Dissectors  
 Face-Lift Dissectores  
 Face-Lift Dissecteurs  
 Face-Lift Dissettori

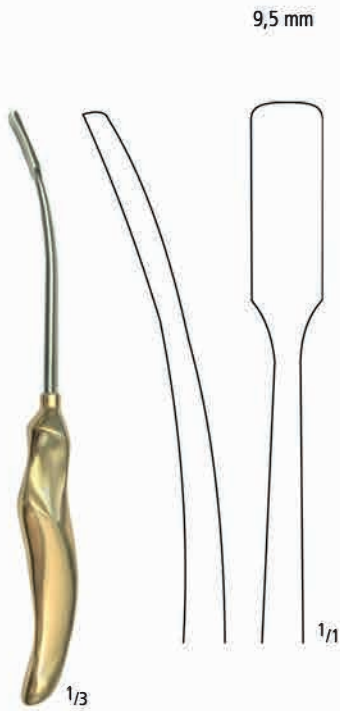

**KA 709/07**  
 24,0 cm/9<sup>1</sup>/<sub>2</sub>"

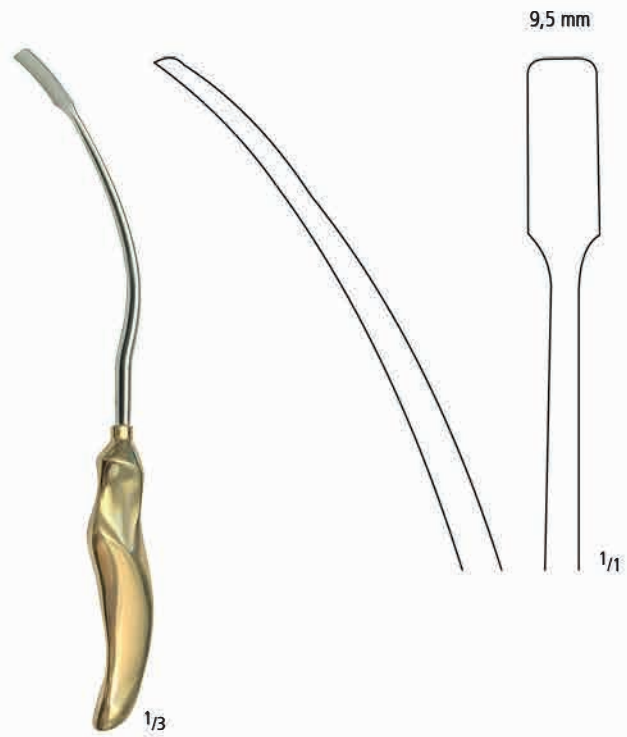

**KA 709/12**  
 28,0 cm/11"



**KA 709/30**  
 22,0 cm/8<sup>3</sup>/<sub>4</sub>"

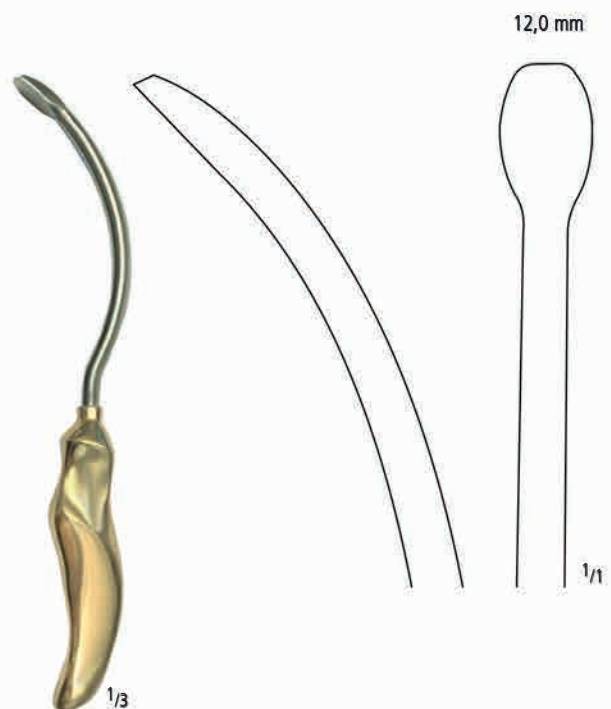

**KA 709/31**  
 25,0cm/9<sup>3</sup>/<sub>4</sub>"

AA  
 AB  
 AC  
 AD  
 AE  
 AF  
 AK  
 AL  
 AO  
 AP  
 AR  
**KA**  
 KL  
 KM  
 KO  
 KU  
 KYE  
 X

Face-Lift Dissektoren  
 Face-Lift Dissectors  
 Face-Lift Disectores  
 Face-Lift Dissecteurs  
 Face-Lift Dissettori



**KA 709/32**  
 23,5 cm/9<sup>1</sup>/<sub>4</sub>"

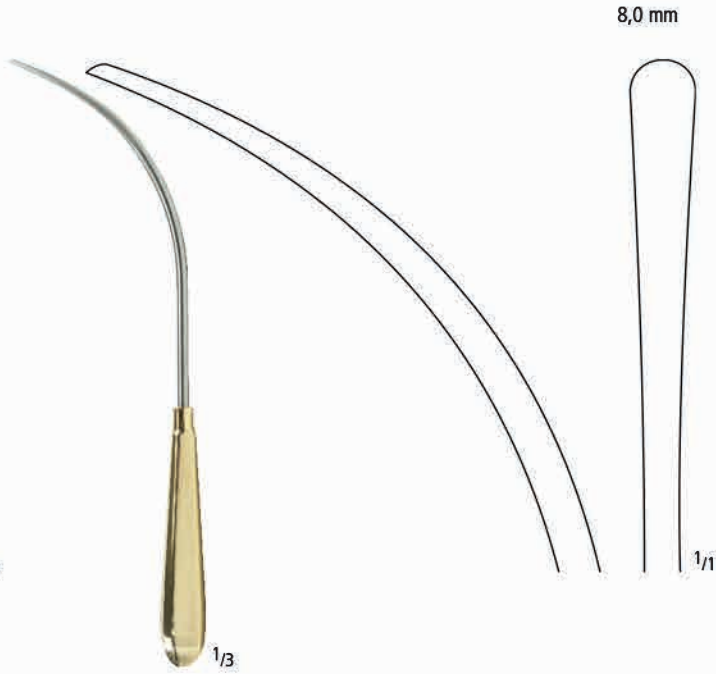

**KA 709/33**  
 24,0 cm/9<sup>1</sup>/<sub>2</sub>"



**KA 709/34**  
 23,5 cm/9<sup>1</sup>/<sub>4</sub>"



**KA 709/35**  
 23,5 cm/9<sup>1</sup>/<sub>4</sub>"



**KA 709/36**  
 23,5 cm/9<sup>1</sup>/<sub>4</sub>"

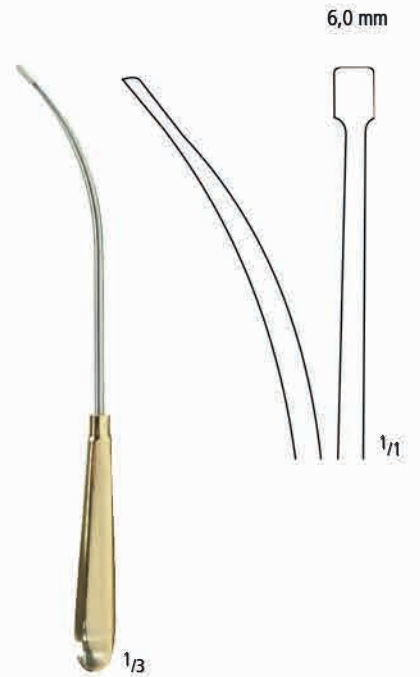

**KA 709/37**  
 23,5 cm/9<sup>1</sup>/<sub>4</sub>"

Face-Lift Dissektoren  
 Face-Lift Dissectors  
 Face-Lift Dissectores  
 Face-Lift Dissecteurs  
 Face-Lift Dissettori



**KA 709/38**  
 21,0 cm/8<sup>1</sup>/<sub>4</sub>"

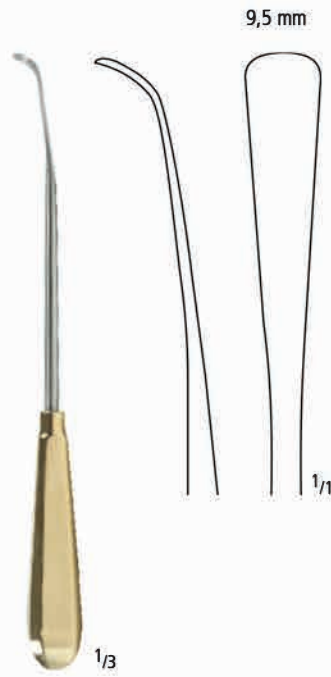

**KA 709/39**  
 23,5 cm/9<sup>1</sup>/<sub>4</sub>"



**KA 709/40**  
 23,5 cm/9<sup>1</sup>/<sub>4</sub>"

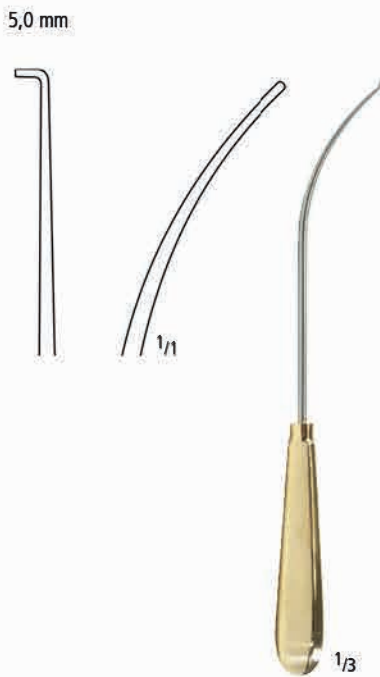

**KA 710/01**  
 23,5 cm/9<sup>1</sup>/<sub>4</sub>"



**KA 710/02**  
 23,5 cm/9<sup>1</sup>/<sub>4</sub>"

AA  
 AB  
 AC  
 AD  
 AE  
 AF  
 AG  
 AH  
 AI  
 AJ  
 AK  
 AL  
 AM  
 AN  
 AO  
 AP  
 AQ  
 AR  
 AS  
 AT  
 AU  
 AV  
 AW  
 AX  
 AY  
 AZ

KA

Hohlmeisselzangen  
 Bone Rongeurs  
 Pinzas-gubias  
 Pincès-gouges  
 Pinze-sgorbie

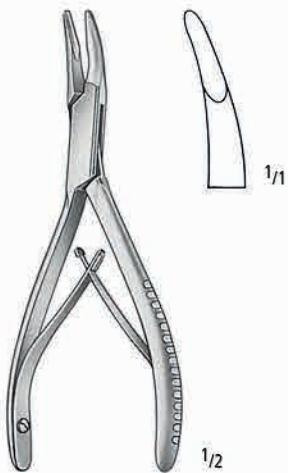

**MINI-FRIEDMAN**  
**KA 800/12**  
 12,0 cm/5"

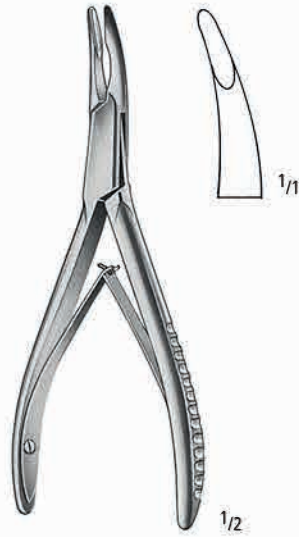

**FRIEDMAN**  
**KA 800/14**  
 14,0 cm/5 1/2"

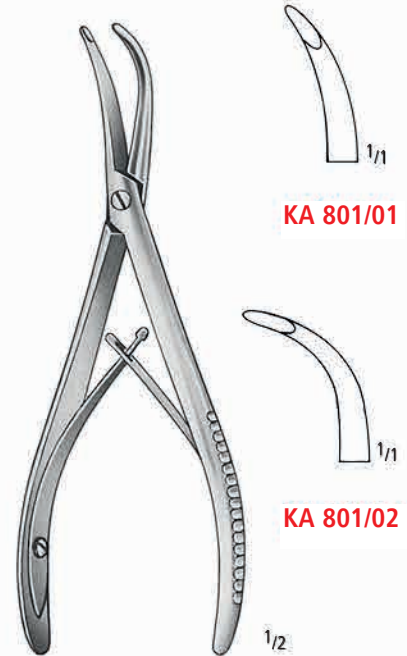

**STELLBRINK**  
 17,0 cm/6 3/4"

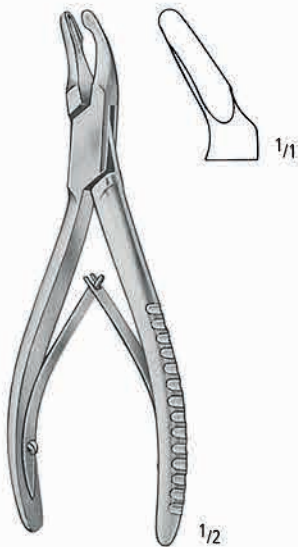

**CLEVELAND**  
**KA 802/14**  
 14,0 cm/5 1/2"

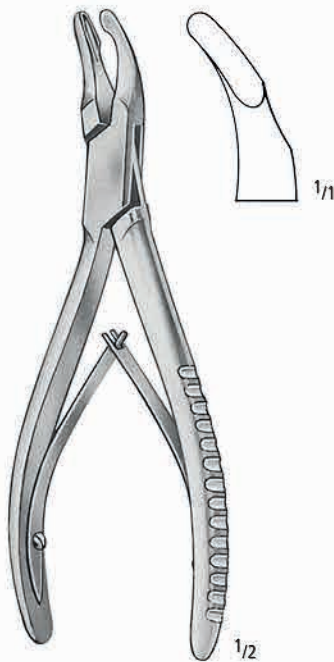

**CLEVELAND**  
**KA 802/17**  
 17,0 cm/6 3/4"

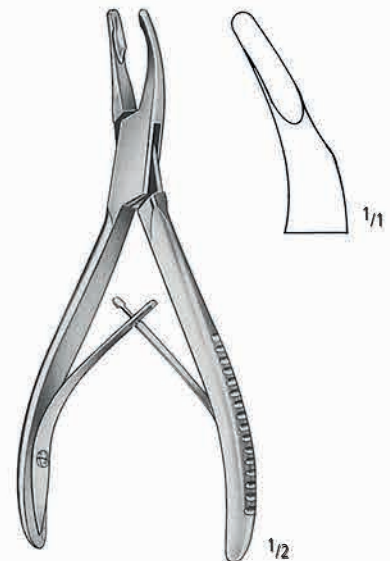

**UNIVERSAL**  
**KA 803/13**  
 13,5 cm/5 1/4"



Hohlmeisselzangen  
 Bone Rongeurs  
 Pinzas-gubias  
 Pincès-gouges  
 Pinze-sgorbie

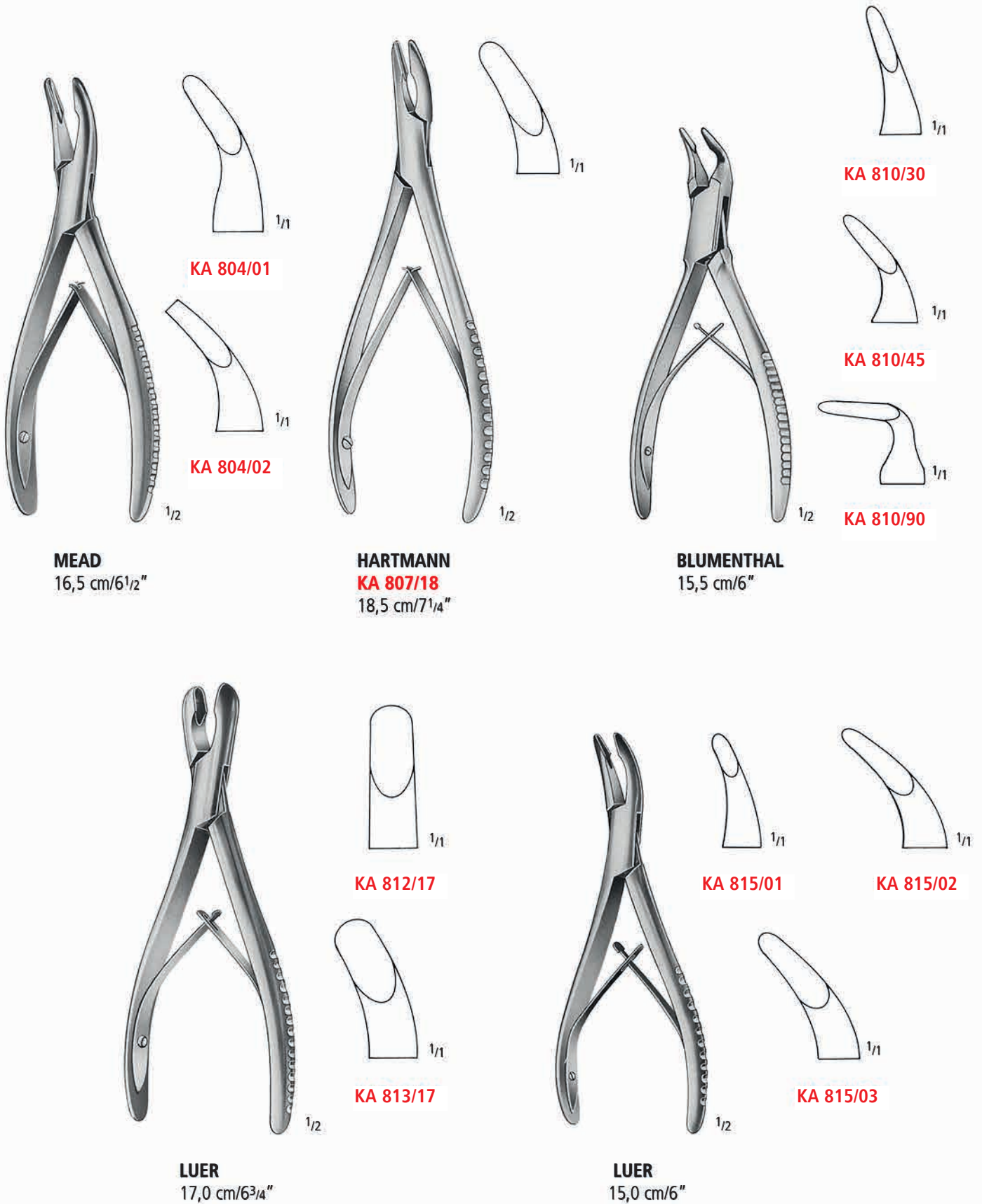

**MEAD**  
 16,5 cm/6 1/2"

**HARTMANN**  
**KA 807/18**  
 18,5 cm/7 1/4"

**BLUMENTHAL**  
 15,5 cm/6"

**LUER**  
 17,0 cm/6 3/4"

**LUER**  
 15,0 cm/6"

AA  
 AB  
 AC  
 AD  
 AE  
 AF  
 AK  
 AL  
 AO  
 AP  
 AR  
 KA  
 KL  
 KM  
 KO  
 KU  
 KYE  
 X



Hohlmeisselzangen  
 Bone Rongeurs  
 Pinzas-gubias  
 Pincès-gouges  
 Pinze-sgorbie



**LEMPERT**  
**KA 816/19**  
 19,0 cm/7 1/2"



**BACON**  
**KA 819/20**  
 20,0 cm/8"



**MARQUARDT**  
**KA 821/20**  
 20,0 cm/8"

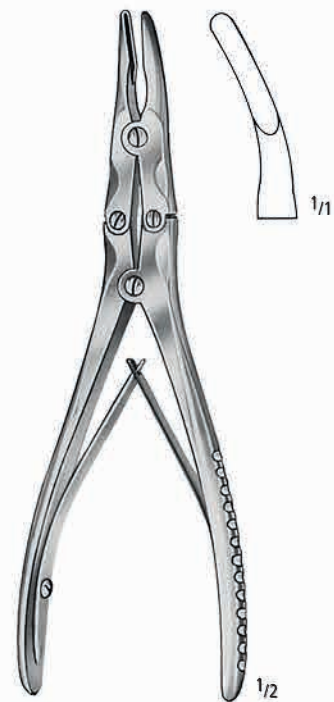

**MAYFIELD**  
**KA 823/17**  
 17,0 cm/6 3/4"

Hohlmeisselzangen  
 Bone Rongeurs  
 Pinzas-gubias  
 Pincas-gouges  
 Pinze-sgorbie



KA 825/01



1/1

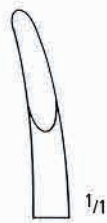

1/1

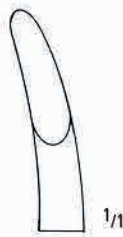

1/1

KA 825/03

1/2

**BÖHLER**  
 15,0 cm/6"

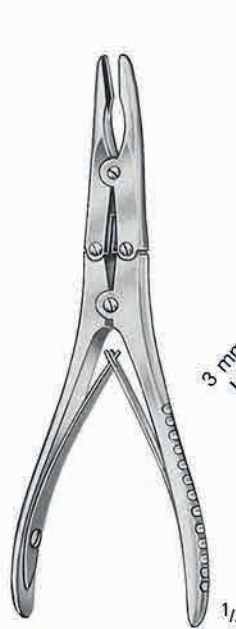

KA 827/02

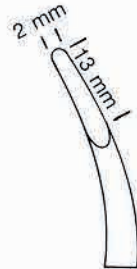

1/1



1/1

KA 827/03

1/2

**KLEINERT-KUTZ**  
 15,0 cm/6"

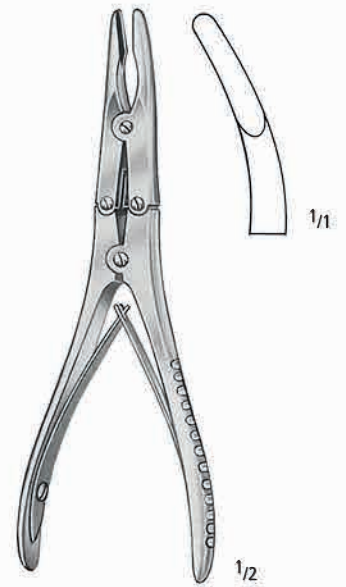

**RUSKIN-MINI**  
**KA 829/15**  
 15,0 cm/6"

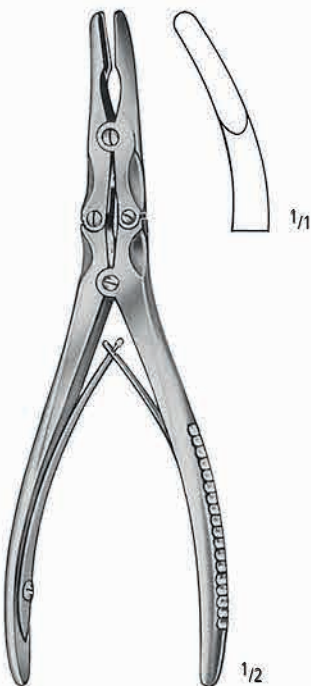

**BEYER**  
**KA 830/18**  
 18,0 cm/7"



**ZAUFAL-JANSEN**  
**KA 835/18**  
 18,0 cm/7"

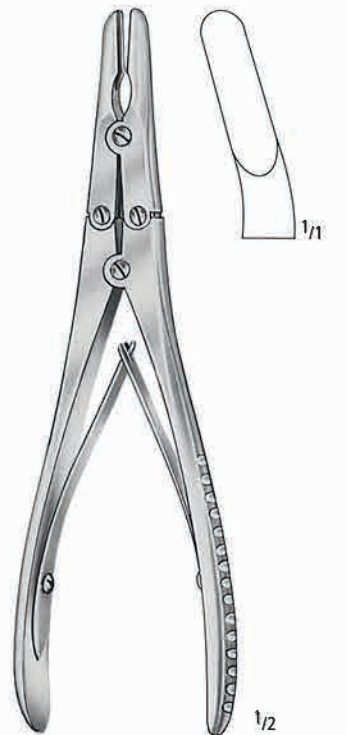

**RUSKIN**  
**KA 836/18**  
 18,0 cm/7"

AA  
 AB  
 AC  
 AD  
 AE  
 AF  
 AK  
 AL  
 AO  
 AP  
 AR  
**KA**  
 KL  
 KM  
 KO  
 KU  
 KYE  
 X

Knochensplitterzangen  
 Bone Cutting Forceps  
 Pinzas cortantes para huesos  
 Pinces coupantes à os  
 Cesioie per ossa

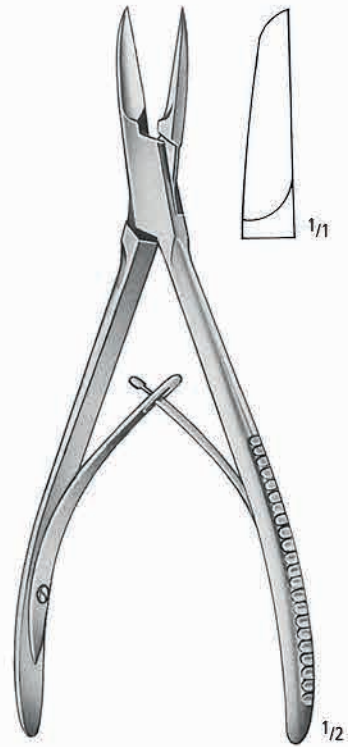

**COTTLE KAZANJIAN**  
**KA 870/19**  
 19,0 cm/7<sup>1</sup>/<sub>2</sub>"

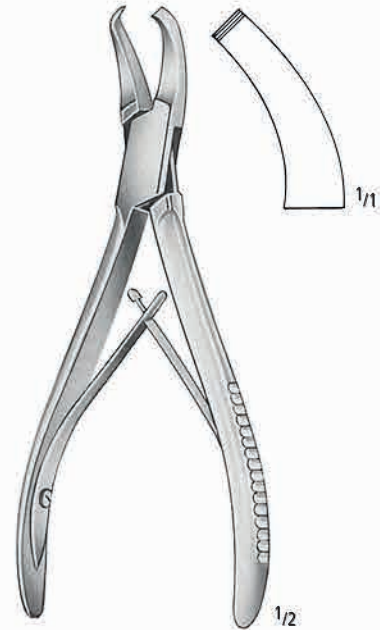

**CLEVELAND-GARDNER**  
**KA 872/16**  
 18,0 cm/6<sup>1</sup>/<sub>4</sub>"

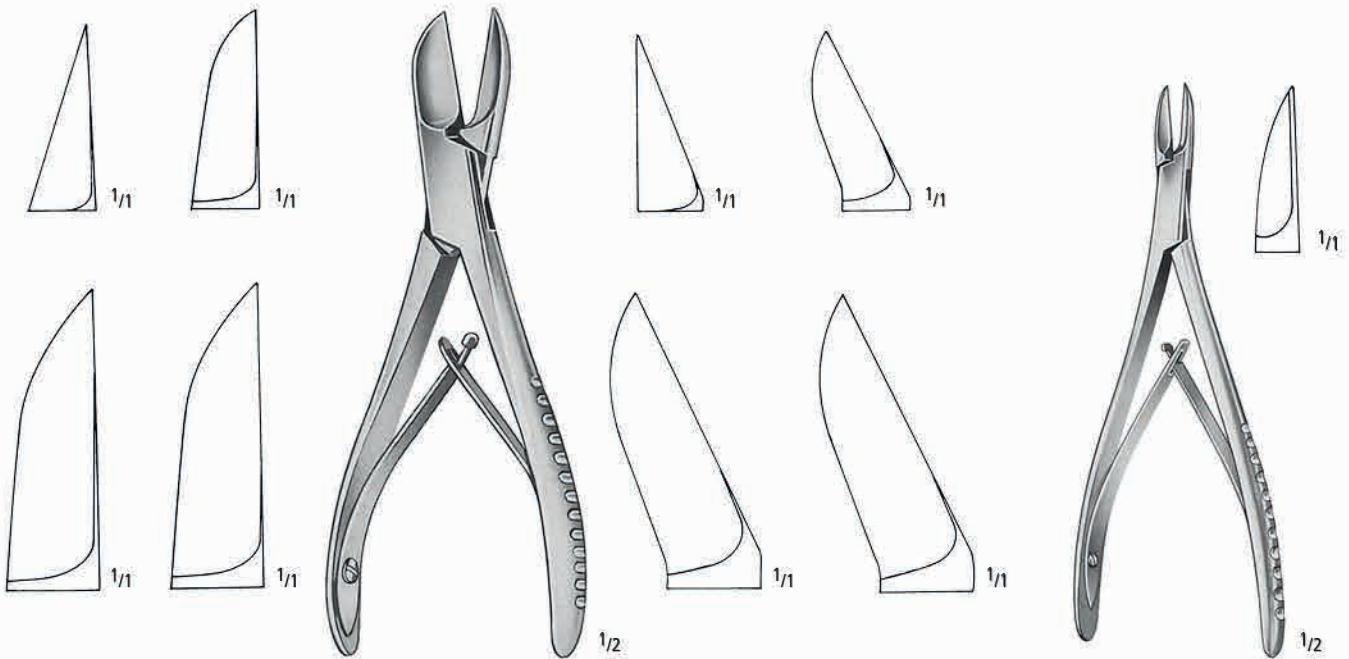

**KA 880/14**  
**KA 880/17**  
**KA 880/19**  
**KA 880/22**

**LISTON**  
 14,0 cm/5<sup>1</sup>/<sub>2</sub>"  
 17,0 cm/6<sup>3</sup>/<sub>4</sub>"  
 19,0 cm/7<sup>1</sup>/<sub>2</sub>"  
 22,0 cm/8<sup>3</sup>/<sub>4</sub>"

**KA 881/14**  
**KA 881/17**  
**KA 881/19**  
**KA 881/22**

**LITTAUER-LISTON**  
**KA 882/15**  
 15,0 cm/6"

Knochensplitterzangen  
 Bone Cutting Forceps  
 Pinzas cortantes para huesos  
 Pinces coupantes à os  
 Cesioie per ossa

AA  
AB  
AC  
AD  
AE  
AF  
AK  
AL  
AO  
AP  
AR  
KA  
KL  
KM  
KO  
KU  
KYE  
X

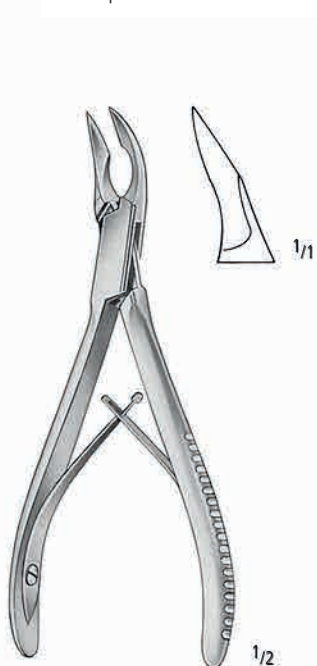

**CLEVELAND**  
**KA 884/15**  
 15,0 cm/6"

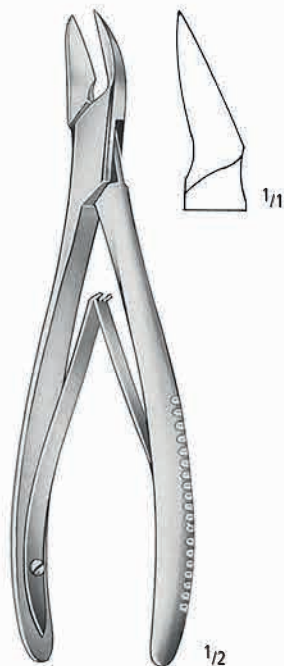

**CLEVELAND**  
**KA 884/17**  
 17,0 cm/6<sup>3</sup>/<sub>4</sub>"

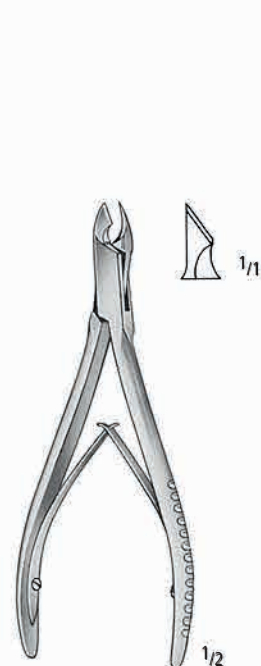

**KA 885/12**  
 12,0 cm/4<sup>3</sup>/<sub>4</sub>"

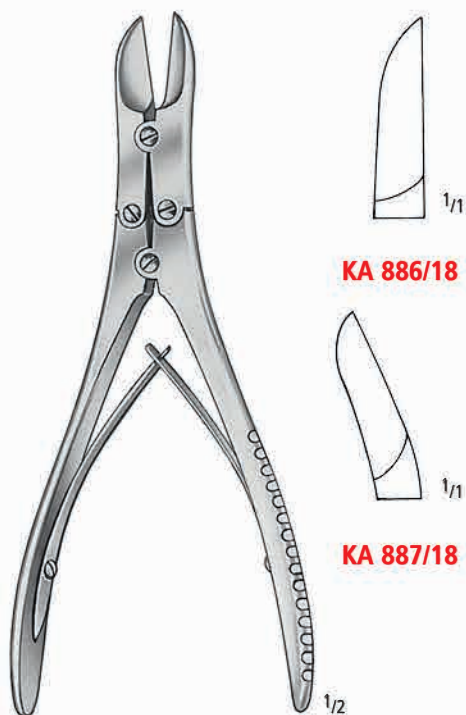

**KA 886/18**

**KA 887/18**

**RUSKIN-LISTON**  
 18,5 cm/7<sup>1</sup>/<sub>4</sub>"

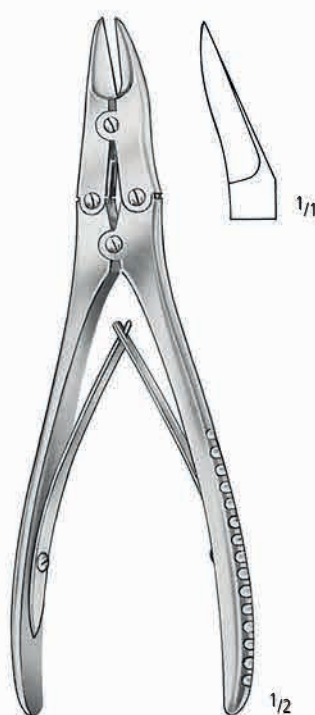

**MC INDOE**  
**KA 888/17**  
 17,5 cm/7"



**WALTON-LISTON**  
**KA 889/01**  
 15,0 cm/6"



Repositionszangen  
 Reposition Forceps  
 Pinzas de reposicion  
 Pinces de reposition  
 Pinze per riposizione



**ROWE**  
**KA 2970/23**  
 23,0 cm/9"

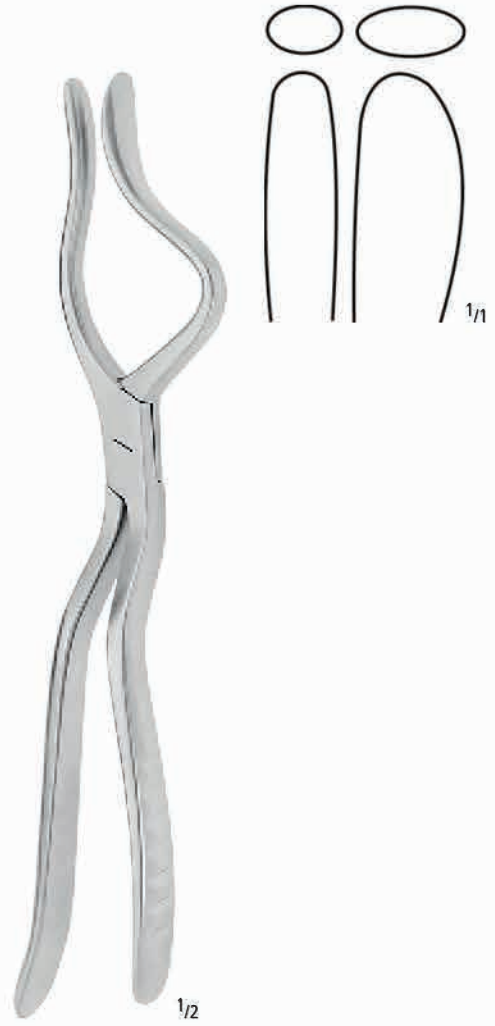

**ROWE**  
**KA 2971/23**  
 23,0 cm/9"



HNO  
ENT  
ORL

KL

nopa<sup>®</sup> instruments

Mund	Seite	229-241
Mouth	Page	229-241
Boca	Página	229-241
Bouche	Page	229-241
Bocca	Pagina	229-241

Tracheotomie	Seite	242-246
Tracheotomy	Page	242-246
Traqueotomía	Página	242-246
Tracheotomie	Page	242-246
Tracheotomia	Pagina	242-246

Tonsillen	Seite	247-255
Tonsils	Page	247-255
Amígdalas	Página	247-255
Amygdales	Page	247-255
Tonsille	Pagina	247-255

Laryngologie	Seite	256-276
Laryngology	Page	256-276
Laringología	Página	256-276
Laryngologie	Page	256-276
Laringologia	Pagina	256-276



**KL** MUND MOUTH BOCA BOUCHE BOCCA

Fingerschützer, Mundkeile, Mundsperrer  
 Finger Protectors, Oral Wedges, Mouth Gags  
 Dedales, Garrotes, Abre-bocas  
 Doigtiers, Baïllons, Ouvre-bouches  
 Ditali, Apribocca

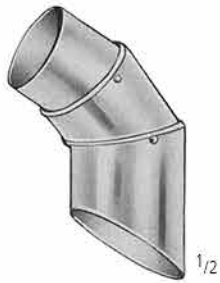

**LANGENBECK**

**KL 015/01**   **KL 015/02**   **KL 015/03**  
 Ø 22,0 mm   Ø 24,5 mm   Ø 26,5 mm

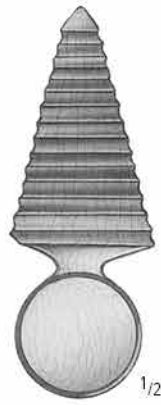

**MAUNDER**  
**KL 018/00**



**PITHA**  
**KL 020/00**



**HEISTER**  
**KL 030/13**  
 13,0 cm/5"



**MOLT**  
**KL 040/11**  
 11,0 cm/4 1/3"

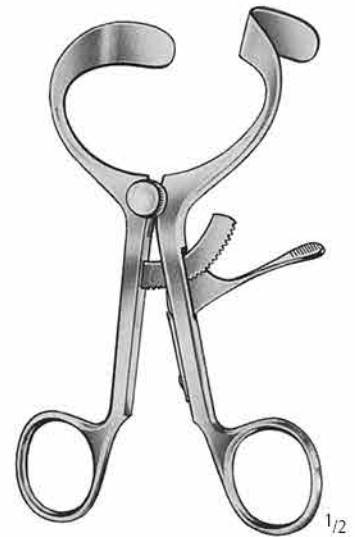

**MOLT**  
**KL 040/14**  
 14,0 cm/5 1/2"

MUND MOUTH BOCA BOUCHE BOCCA

Mundsperrer  
Mouth Gags  
Abre-bocas  
Ouvre-bouches  
Apribocca



**DENHART**  
**KL 042/12**  
12,0 cm/4<sup>3</sup>/<sub>4</sub>"

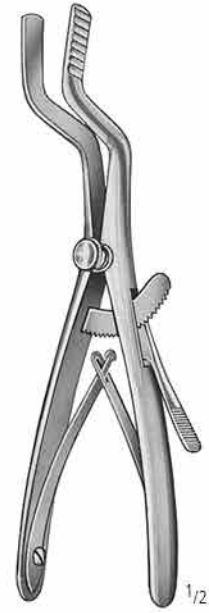

**ROSER-KÖNIG**  
16,0 cm/6<sup>1</sup>/<sub>4</sub>" **KL 044/16**  
19,0 cm/7<sup>1</sup>/<sub>2</sub>" **KL 044/19**

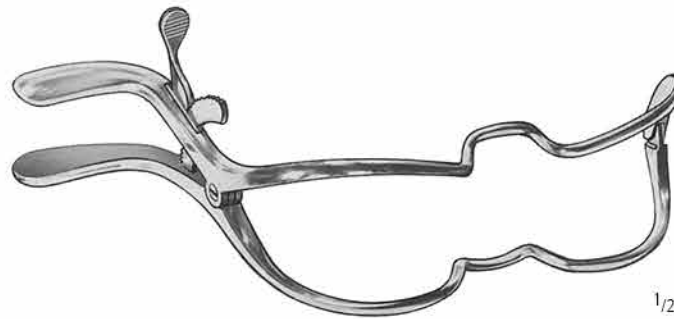

**JENNINGS**  
**KL 046/09** 9,0 cm/3<sup>1</sup>/<sub>2</sub>"  
**KL 046/11** 11,0 cm/4<sup>1</sup>/<sub>3</sub>"  
**KL 046/13** 13,0 cm/5"  
**KL 046/15** 15,0 cm/6"

AA  
AB  
AC  
AD  
AE  
AF  
AK  
AL  
AO  
AP  
AR  
KA  
KL  
KM  
KO  
KU  
KYE  
X

**KL** MUND MOUTH BOCA BOUCHE BOCCA

Mundsperrer  
 Mouth Gags  
 Abre-bocas  
 Ouvre-bouches  
 Apribocca

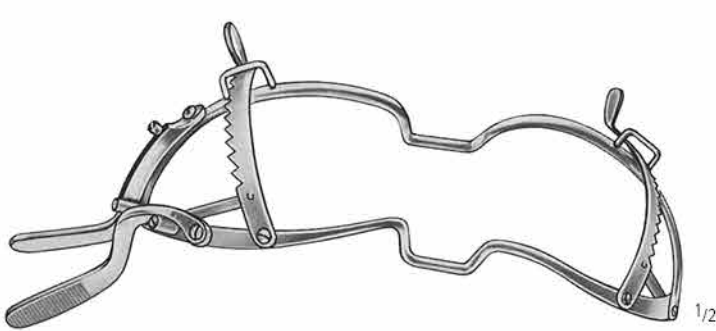

**WHITEHEAD**  
**KL 048/11**  
**KL 048/13**  
**KL 048/15**

11,0 cm/4<sup>1</sup>/<sub>3</sub>"  
 13,0 cm/5"  
 15,0 cm/6"

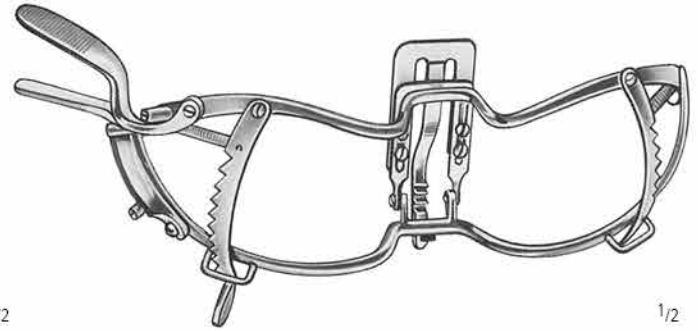

**WHITEHEAD**  
**KL 049/11**  
**KL 049/13**  
**KL 049/15**



**KILNER-DOUGHTY**  
**KL 060/00**  
 komplett  
 complete  
 completo  
 complet  
 completo



Fig. 1  
**KL 060/01**  
 65x28 mm



Fig. 2  
**KL 060/02**  
 75x32 mm



Fig. 3  
**KL 060/03**  
 80x37 mm



**KL 060/08**

MUND MOUTH BOCA BOUCHE BOCCA

Mundsperrer  
Mouth Gags  
Abre-bocas  
Ouvre-bouches  
Apribocca

AA  
AB  
AC  
AD  
AE  
AF  
AK  
AL  
AO  
AP  
AR  
KA  
KL  
KM  
KO  
KU  
KYE  
X

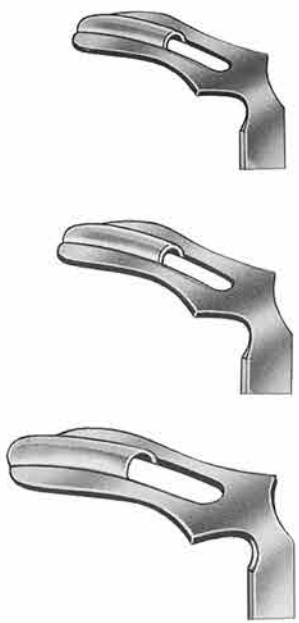
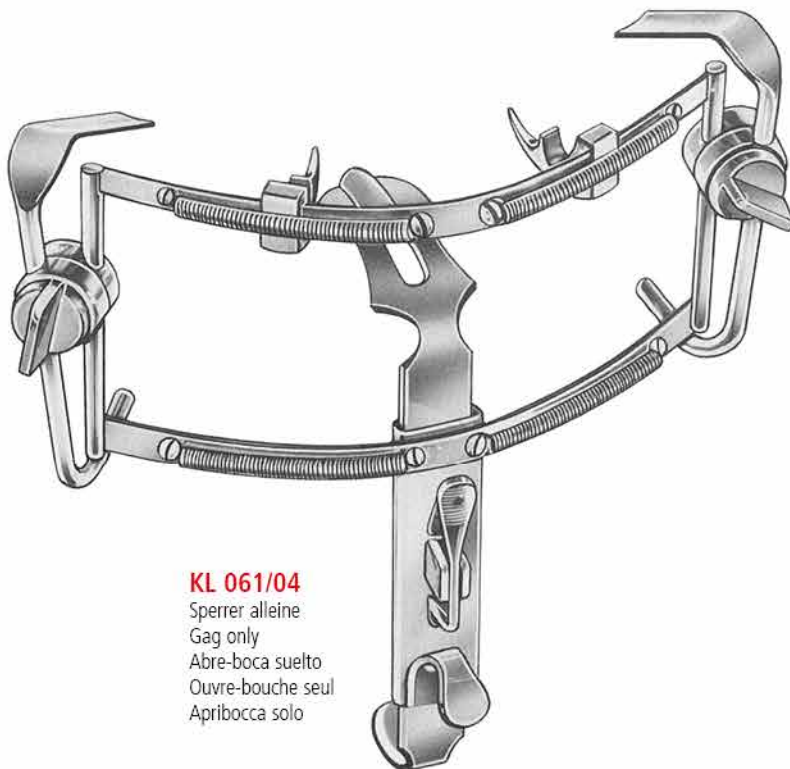

Fig. 1  
**KL 061/01**  
55x25 mm

Fig. 2  
**KL 061/02**  
60x27 mm

Fig. 3  
**KL 061/03**  
70x30 mm



**KL 061/04**  
Sperrer alleine  
Gag only  
Abre-boca suelto  
Ouvre-bouche seul  
Apribocca solo

**DINGMANN**  
**KL 061/00**  
komplett  
complete  
completo  
complet  
completo



**KL 064/06**  
Sperrer alleine  
Gag only  
Abre-boca suelto  
Ouvre-bouche seul  
Apribocca solo



**KL 064/08**  
Silikon  
Silicon  
Silicona  
Silicone  
Silicone

**DAVIS-BOYLE**  
**KL 064/00**  
komplett  
complete  
completo  
complet  
completo



Fig. 1  
**KL 064/01**  
105x27 mm



Fig. 2  
**KL 064/02**  
90x25 mm



Fig. 3  
**KL 064/03**  
75x25 mm



Fig. 4  
**KL 064/04**  
60x22 mm

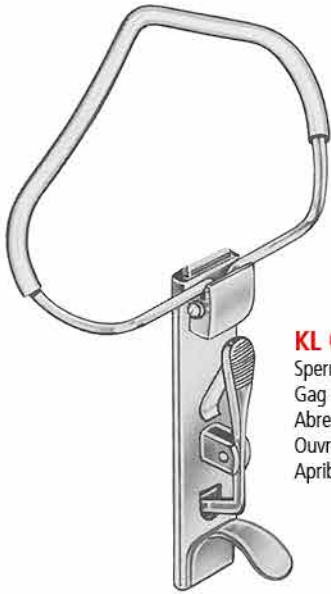

Fig. 5  
**KL 064/05**  
25x20 mm



**KL** MUND MOUTH BOCA BOUCHE BOCCA

Mundsperrer  
 Mouth Gags  
 Abre-bocas  
 Ouvre-bouches  
 Apribocca



**KL 066/04**  
 Sperrer alleine  
 Gag only  
 Abre-boca suelto  
 Ouvre-bouche seul  
 Apribocca solo

**MC IVOR**  
**KL 066/00**  
 komplett  
 complete  
 completo  
 complet  
 completo

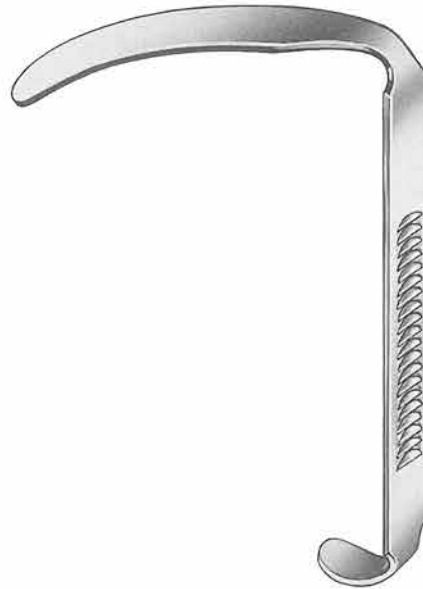

Fig. 1  
**KL 066/01**  
 95x27 mm



Fig. 2  
**KL 066/02**  
 85x22 mm



Fig. 3  
**KL 066/03**  
 70x22 mm



links  
 left  
 à gauche  
 a sinistra  
 a la izquierda



rechts  
 right  
 à droite  
 a destra  
 a la derecha

**RING**

Fig.		
2	<b>KL 067/02</b>	65x24 mm
3	<b>KL 067/03</b>	72x27 mm
4	<b>KL 067/04</b>	87x34 mm
5	<b>KL 067/05</b>	95x37 mm

<b>KL 067/12</b>	
<b>KL 067/13</b>	
<b>KL 067/14</b>	
<b>KL 067/15</b>	



**MODELL WÜRZBURG**

Fig.		
1	66x28 mm	<b>KL 068/01</b>
2	75x32 mm	<b>KL 068/02</b>
3	83x34 mm	<b>KL 068/03</b>
4	93x37 mm	<b>KL 068/04</b>
5	100x38 mm	<b>KL 068/05</b>

MUND MOUTH BOCA BOUCHE BOCCA

Mundsperrer  
Mouth Gags  
Abre-bocas  
Ouvre-bouches  
Apribocca

links  
left  
à gauche  
a sinistra  
a la izquierda



**DAVIS-MAYER**  
**KL 069/01**

rechts  
right  
à droite  
a destra  
a la derecha



**DAVIS-MAYER**  
**KL 069/03**



**DAVIS-MAYER**

Fig.		
1	70 mm	<b>KL 069/11</b>
2	75 mm	<b>KL 069/12</b>
3	80 mm	<b>KL 069/13</b>
4	85 mm	<b>KL 069/14</b>



**HERBERHOLD**

Fig.		
1	63x28 mm	<b>KL 070/01</b>
2	73x33 mm	<b>KL 070/02</b>
3	82x37 mm	<b>KL 070/03</b>
4	90x42 mm	<b>KL 070/04</b>

AA  
AB  
AC  
AD  
AE  
AF  
AK  
AL  
AO  
AP  
AR  
KA  
KL  
KM  
KO  
KU  
KYE  
X

Mundsperrer  
 Mouth Gags  
 Abre-bocas  
 Ouvre-bouches  
 Apribocca



**KL 072/01**

Band für Bruststütze für Mundsperrer  
 Band for Chest support for Mouth Gag  
 La bande Soporte contra-pecho para abre-bocas  
 Nastro Support contre-poitrine pour ouvre-bouches  
 La cinta Supporto contro-petto per apribocca



**NEGUS**

**KL 072/08** = 8,5 cm/3<sup>1</sup>/<sub>4</sub>"  
**KL 072/11** = 11,0 cm/4<sup>1</sup>/<sub>4</sub>"  
**KL 072/14** = 14,0 cm/5<sup>1</sup>/<sub>2</sub>"

Bruststütze für Mundsperrer  
 Chest support for Mouth Gag  
 Soporte contra-pecho para abre-bocas  
 Support contre-poitrine pour ouvre-bouches  
 Supporto contro-petto per apribocca



**DRAFFIN**  
**KL 073/00**

Bruststütze für Mundsperrer  
 Bipod for mouth gag  
 Soporte de pecho bipod  
 Support de poitrine bipod  
 Supporto di petto bipod

Mundkeile  
 Oral Wedges  
 Garrotes  
 Baïllons  
 Apribocca

für Erwachsene  
 for adults  
 para adultos  
 pour adultes  
 per adulti

für Kinder  
 for children  
 para niños  
 pour enfants  
 per bambini



1/2

**McKESSON**  
**KL 080/00-04**



**KL 080/00**



**KL 080/03**



**KL 080/01**



**KL 080/04**



**KL 080/02**



1/2

**McKESSON**  
**KL 082/01-04**



**KL 082/01**



**KL 082/03**

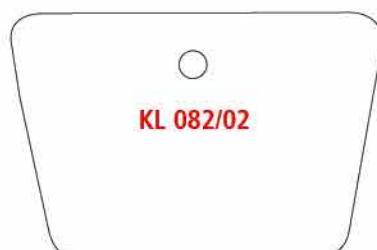

**KL 082/02**

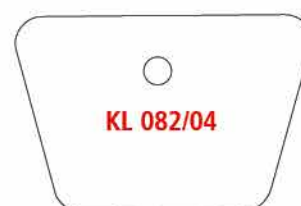

**KL 082/04**

AA  
 AB  
 AC  
 AD  
 AE  
 AF  
 AK  
 AL  
 AO  
 AP  
 AR  
 KA  
 KL  
 KM  
 KO  
 KU  
 KYE  
 X

**KL** ZUNGE TONGUE LENGUA LANGUE LINGUA

Wangen- und Lippenhalter, Zungendrücker  
 Cheek and Lip Retractors, Tongue Depressors  
 Separadores para mejillas y labios, Abaja-lenguas  
 Ecarteurs des joues et des lèvres, Abaisse-langues  
 Divaricatori per guancie e labbra, Abbassalingua

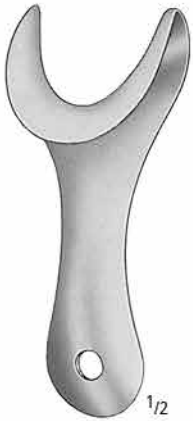

**SIMPLEX**  
**KL 100/11**  
 11,0 cm/4<sup>1</sup>/<sub>3</sub>"



**LACK**  
**KL 103/13** = 13,0 cm/5"  
**KL 103/19** = 19,0 cm/7<sup>1</sup>/<sub>2</sub>"  
**KL 103/22** = 22,0 cm/8<sup>3</sup>/<sub>4</sub>"



**STERNBERG**  
**KL 105/12** = 12,0 cm/4<sup>3</sup>/<sub>4</sub>"  
**KL 105/14** = 14,0 cm/5<sup>1</sup>/<sub>2</sub>"  
**KL 105/16** = 16,0 cm/6<sup>1</sup>/<sub>4</sub>"

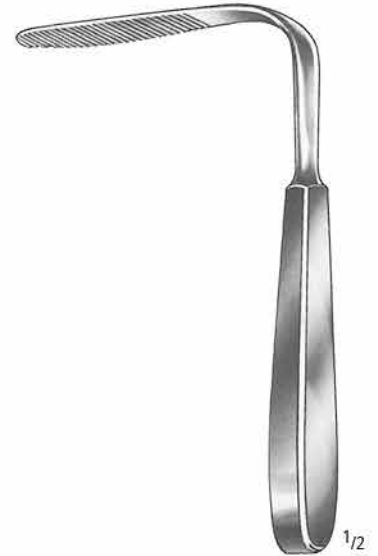

**TOBOLD**  
**KL 112/14**  
 14,5 cm/5<sup>3</sup>/<sub>4</sub>"



**HARTMANN**  
**KL 114/15**  
 15,0 cm/6"



**MORITZ-SCHMIDT**  
**KL 116/19**  
 19,0 cm/7<sup>1</sup>/<sub>2</sub>"



**WIEDER**  
 14,5 cm/5<sup>3</sup>/<sub>4</sub>"

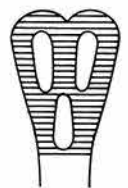

**KL 120/14**  
 28 mm

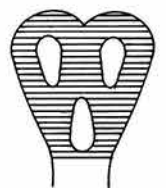

**KL 120/15**  
 32 mm



ZUNGE TONGUE LENGUA LANGUE LINGUA

Wangen- und Lippenhalter, Zungendrucker  
 Cheek and Lip Retractors, Tongue Depressors  
 Separadores para mejillas y labios, Abaja-lenguas  
 Ecarteurs des joues et des lèvres, Abaisse-langues  
 Divaricatori per guancie e labbra, Abbassalingua



**KL 122/19**  
 19,0 cm/7<sup>1</sup>/<sub>2</sub>"



**STANDARD**  
**KL 124/14**  
 14,5 cm/5<sup>3</sup>/<sub>4</sub>"



**UNIV. MINNESOTA**  
**KL 125/14**  
 14,0 cm/5<sup>1</sup>/<sub>2</sub>"



**KROENIG**  
**KL 126/15**  
 15,0 cm/6"



**MAYO**  
**KL 128/17**  
 17,0 cm/6<sup>3</sup>/<sub>4</sub>"



**DOYEN**  
**KL 129/13**  
 13,0 cm/5"



**DOYEN**  
**KL 129/16**  
 16,0 cm/6<sup>1</sup>/<sub>4</sub>"



**BRUENINGS**  
**KL 130/19**  
 19,0 cm/7<sup>1</sup>/<sub>2</sub>"



**FRENZEL**  
**KL 131/16**  
 16,5 cm/6<sup>1</sup>/<sub>2</sub>"



**KL 132/18**  
 18,0 cm/7"

AA  
 AB  
 AC  
 AD  
 AE  
 AF  
 AK  
 AL  
 AO  
 AP  
 AR  
 KA  
**KL**  
 KM  
 KO  
 KU  
 KYE  
 X

**KL** MUND MOUTH BOCA BOUCHE BOCCA

Retraktoren, Zungenzangen  
 Retractors, Tongue Holding Forceps  
 Separadores, Pinzas tira-lengua  
 Ecarteurs, Pincés tire-langue  
 Divaricatori, Pinze tiralingua



**KL 133/16**  
 16,5 cm/6<sup>1</sup>/<sub>2</sub>"



**KL 134/22**  
 22,0 cm/8<sup>3</sup>/<sub>4</sub>"  
 16,0 mm



**KL 135/01**  
 21,0 cm/8<sup>1</sup>/<sub>4</sub>"



**KL 135/02**  
 21,0 cm/8<sup>1</sup>/<sub>4</sub>"



**KL 136/25**  
 25,0 cm/10"  
 12,5/27,0 mm



**COLLIN**  
**KL 140/16**  
 16,0 cm/6<sup>1</sup>/<sub>4</sub>"



**YOUNG**  
**KL 144/17**  
 17,0 cm/6<sup>3</sup>/<sub>4</sub>"

**KL 144/99**  
 Paar  
 pair  
 par  
 pairé  
 paio

MUND MOUTH BOCA BOUCHE BOCCA

Retraktoren, Zungenzangen, Trokare  
 Retractors, Tongue Holding Forceps, Trocars  
 Separadores, Pinzas tira-lengua, Traqueótomos  
 Ecarteurs, Pincas tire-langue, Trachéotomes  
 Divaricatori, Pinze tiralingua, Tracheotomi



**UCKERMANN**

7,5 mm  
**KL 150/07**

9,0 mm  
**KL 150/09**



**STIERLEN**

L  
**KL 153/07** = 7,0 cm/2<sup>3</sup>/<sub>4</sub>"  
**KL 153/09** = 9,0 cm/3<sup>1</sup>/<sub>2</sub>"  
**KL 153/10** = 10,0 cm/4"

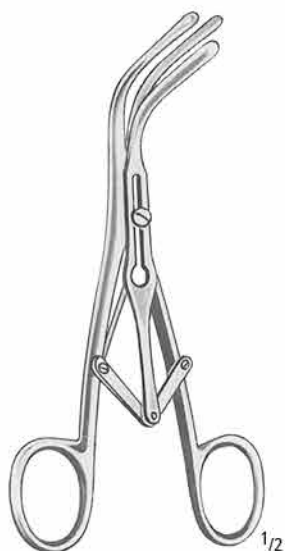

**LABORDE**  
**KL 155/14**  
 14,0 cm/5<sup>1</sup>/<sub>2</sub>"

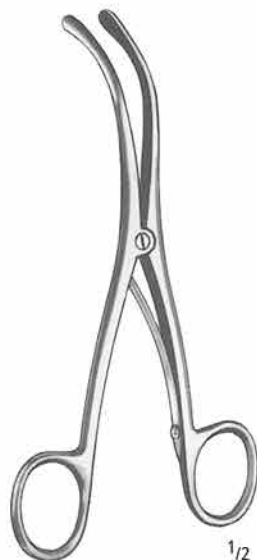

**TROUSSEAU**  
**KL 157/14**  
 14,0 cm/5<sup>1</sup>/<sub>2</sub>"



**WEERDA**  
**KL 158/19**  
 19,0 cm/ 7<sup>1</sup>/<sub>2</sub>"



**BOSE**  
**KL 159/07**  
 7,0 cm/2<sup>3</sup>/<sub>4</sub>"

AA  
 AB  
 AC  
 AD  
 AE  
 AF  
 AK  
 AL  
 AO  
 AP  
 AR  
 KA  
 KL  
 KM  
 KO  
 KU  
 KYE  
 X

Tracheal-Häkchen  
Trachea Retractors  
Separadores para la tráquea  
Ecarteurs pour trachéotomie  
Uncini tracheali



links  
left  
izquierdo  
à gauche  
sinistro

**BOSE**  
**KL 166/01**  
16,0 cm/6<sup>1</sup>/<sub>4</sub>"



rechts  
right  
derecho  
à droite  
destro

**BOSE**  
**KL 166/02**  
16,0 cm/6<sup>1</sup>/<sub>4</sub>"



**KL 167/01**

**KL 167/02**

**ITERSON**  
16,0 cm/6<sup>1</sup>/<sub>4</sub>"



**SCHOENBORN**  
**KL 176/21**  
21,0 cm/8<sup>1</sup>/<sub>4</sub>"



**LUKENS**  
**KL 177/17**  
17,0 cm/6<sup>3</sup>/<sub>4</sub>"

TRACHEOTOMIE TRACHEOTOMY TRAQUEOTOMIA TRACHEOTOMIE TRACHEOTOMIA

Tracheal-Häkchen  
Trachea Retractors  
Separadores para la tráquea  
Ecarteurs pour trachéotomie  
Uncini tracheali



**KL 178/01**



**KL 178/02**



**JACKSON**  
**KL 179/17**  
17,0 cm/6<sup>3</sup>/<sub>4</sub>"



**ROSE**  
**KL 180/13**  
13,0 cm/5"



**LUER**  
**KL 181/11**  
11,0 cm/4<sup>1</sup>/<sub>3</sub>"



**JACKSON**  
**KL 182/15**  
15,0 cm/6"



**NEWS**  
**KL 183/15**  
15,0 cm/6"



**HUPP**  
**KL 184/15**  
15,0 cm/6"



**WAGNER-MOSHER**  
Ø 5,0 mm **KL 185/05**  
Ø 7,0 mm **KL 185/07**  
Ø 9,0 mm **KL 185/09**

AA  
AB  
AC  
AD  
AE  
AF  
AK  
AL  
AO  
AP  
AR  
KA  
KL  
KM  
KO  
KU  
KYE  
X



**KL** TRACHEOTOMIE TRACHEOTOMY TRAQUEOTOMIA TRACHEOTOMIE TRACHEOTOMIA

Tracheal-Kanülen  
Trachea Tubes  
Cánulas traqueales  
Canules pour trachéotomie  
Canule tracheali

Internationale Größenskala  
International scale  
Escala internacional  
Echelle internationale  
Scala internazionale

Fig.	0	1	2	3	4	5	6	7	8	9
Ø mm	4	5	6	7	8	9	10	11	12	13
Charr./Fr.	12	15	18	21	24	27	30	33	36	39
Länge	45	50	55	60	65	70	75	80	85	90

Länge des Außenrohrs  
Length of outer tube  
Large de la cánula exterior  
Longueur du tube extérieur  
Lunghezza del tubo esterno

Sprechkanüle  
Speaking tube  
Cánula parlante  
Canule parlante  
Cannula parlante



**Standard**



**CHEVALIER-JACKSON**

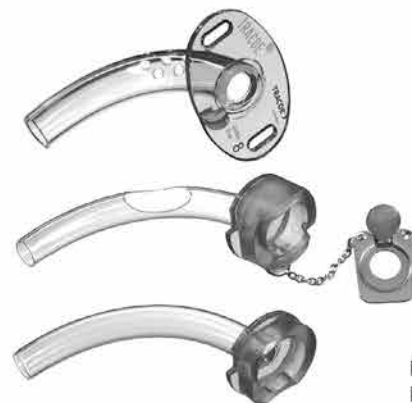

Kunststoff  
Plastic  
El plástico  
Plastique  
Materia plastica

Fig.	mm Ø	LUER	CHEVALIER-JACKSON	65-90 mm
0	4	<b>KL 200/04</b>	<b>KL 206/04</b>	
1	5	<b>KL 200/05</b>	<b>KL 206/05</b>	
2	6	<b>KL 200/06</b>	<b>KL 206/06</b>	
3	7	<b>KL 200/07</b>	<b>KL 206/07</b>	
4	8	<b>KL 200/08</b>	<b>KL 206/08</b>	<b>KL 210/08</b>
5	9	<b>KL 200/09</b>	<b>KL 206/09</b>	<b>KL 210/09</b>
6	10	<b>KL 200/10</b>	<b>KL 206/10</b>	<b>KL 210/10</b>
7	11	<b>KL 200/11</b>	<b>KL 206/11</b>	<b>KL 210/11</b>
8	12	<b>KL 200/12</b>	<b>KL 206/12</b>	<b>KL 210/12</b>
9	13	<b>KL 200/13</b>	<b>KL 206/13</b>	<b>KL 210/13</b>



**GUEDEL** Size 0-4, 10 pieces  
Airways Set  
**KL 215/00**

TRACHEOTOMIE TRACHEOTOMY TRAQUEOTOMIA TRACHEOTOMIE TRACHEOTOMIA

Tracheotomie-Besteck  
Tracheotomy Set  
Estuche para traqueotomía  
Jeu d'instruments pour trachéotomie  
Set per tracheotomia



KL 234/00

bestehend aus:

- AD 010/04 1 Metalletui
- AD 010/04 1 Griff und 1 Klinge Fig. 20
- AD 010/04 1 Griff und 1 Klinge Fig. 23
- AB 050/13 1 Anatomische Pinzette 13,0 cm
- AB 060/13 2 Chirurgische Pinzetten 13,0 cm
- AA 214/13 2 Pean Klemmen 13,0 cm
- AL 015/13 1 Hohlsonde 13,0 cm
- KL 159/07 1 Trachealdilator Bose
- KL 167/02 2 Trachealhäkchen Iterson, stumpf
- KL 166/01 1 Trachealhäkchen Bose, scharf, links
- KL 166/02 1 Trachealhäkchen Bose, scharf, rechts
- KL 200/07 1 Trachealkanüle Luer Standard, Fig. 2
- KL 200/08 1 Trachealkanüle Luer Standard, Fig. 4
- 1 Reinigungsbürste

compuesto de:

- AD 010/04 1 Estuche de metal
- AD 010/04 1 Mango con 1 hoja fig. 20
- AD 010/04 1 Mango con 1 hoja fig. 23
- AB 050/13 1 Pinza de disección, 13,0 cm
- AB 060/13 2 Pinzas de disección, 13,0 cm, 1:2
- AA 214/13 2 Pean Pinzas hemostáticas, 13,0 cm
- AL 015/13 1 Sonda acanalada, 13,0 cm
- KL 159/07 1 Dilatador traqueal Bose
- KL 167/02 2 Separadores traqueales Iterson, romos
- KL 166/01 1 Separador traqueal, agudo, izquierdo
- KL 166/02 1 Separador traqueal, agudo, derecho
- KL 200/07 1 Luer Cánula traqueal, Standard, fig. 2
- KL 200/08 1 Luer Cánula traqueal, Standard, fig. 4
- 1 Cepillo de limpieza

composto da:

- AD 010/04 1 scatola in metallo
- AD 010/04 1 Manico di bisturi con 1 lama fig. 20
- AD 010/04 1 Manico di bisturi con 1 lama fig. 23
- AB 050/13 1 Pinza per dissezione, 13,0 cm
- AB 060/13 2 Pinze per dissezione, 13,0 cm, 1:2
- AA 214/13 2 Pinze emostatiche Pean, 13,0 cm
- AL 015/13 1 Sonda scanalata, 13,0 cm
- KL 159/07 1 Dilatatore tracheale Bose
- KL 167/02 2 Uncini tracheali Iterson, smussi
- KL 166/01 1 Uncino tracheale Bose, acuto, sinistro
- KL 166/02 1 Uncino tracheale Bose, acuto, destro
- KL 200/07 1 Luer Cannula tracheale Standard, fig. 2
- KL 200/08 1 Luer Cannula tracheale Standard, fig. 4
- 1 Spazzolino per pulire

consisting of:

- AD 010/04 1 Metal case
- AD 010/04 1 Handle with 1 blade Fig. 20
- AD 010/04 1 Handle with 1 blade Fig. 23
- AB 050/13 1 Dressing Forceps 13,0 cm
- AB 060/13 2 Tissue Forceps 13,0 cm
- AA 214/13 2 Pean Artery Forceps 13,0 cm
- AL 015/13 1 Grooved Director 13,0 cm
- KL 159/07 1 Trachea Dilator Bose
- KL 167/02 2 Trachea Retractors, Iterson, blunt
- KL 166/01 1 Trachea Retractor, Bose, sharp, left
- KL 166/02 1 Trachea Retractor, Bose, sharp, right
- KL 200/07 1 Luer Trachea Tube Standard, Fig. 2
- KL 200/08 1 Luer Trachea Tube Standard, Fig. 4
- 1 Cleaning Brush

composé de:

- AD 010/04 1 boîte métal
- AD 010/04 1 Manche de bistouri et 1 lame fig. 20
- AD 010/04 1 Manche de bistouri et 1 lame fig. 23
- AB 050/13 1 Pince à dissection, 13,0 cms
- AB 060/13 2 Pinces à griffes, 13,0 cms
- AA 214/13 2 Pinces hémostatiques Péan, 13,0 cms
- AL 015/13 1 Sonde cannelée, 13,0 cms
- KL 159/07 1 Dilatateur trachéal Bose
- KL 167/02 2 Erignes trachéales Iterson, mouses
- KL 166/01 1 Erigne trachéale Bose, pointue, à gauche
- KL 166/02 1 Erigne trachéale Bose, pointue, à droite
- KL 200/07 1 Luer Canule trachéale Standard, fig. 2
- KL 200/08 1 Luer Canule trachéale Standard, fig. 4
- 1 Brosse à nettoyer

AA  
AB  
AC  
AD  
AE  
AF  
AK  
AL  
AO  
AP  
AR  
KA  
KL  
KM  
KO  
KU  
KYE  
X

Sonden, Fasszangen, Muskelklemme  
 Directors, Seizing Forceps, Muscular Clamp  
 Sondas, Pinzas para el bocio, Pinza para músculos  
 Sondes, Pince à goitre, Pince musculaire  
 Sonde, Pinze per gozzo, Pinza muscolare



**KOCHER**

15,0 cm/6"  
 16,0 cm/6<sup>1</sup>/<sub>4</sub>"  
 18,0 cm/7"

**KL 240/15**  
**KL 240/16**

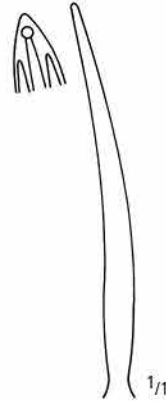
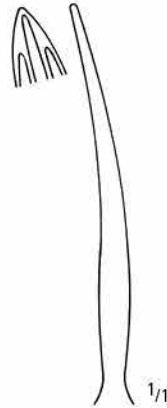

**KL 241/15**  
**KL 241/16**

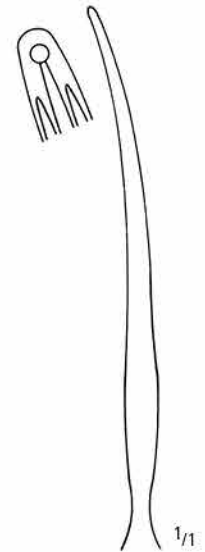

**KL 242/18**



**LAHEY**

**KL 244/15**  
 15,0 cm/6"



**KL 244/20**  
 20,0 cm/8"

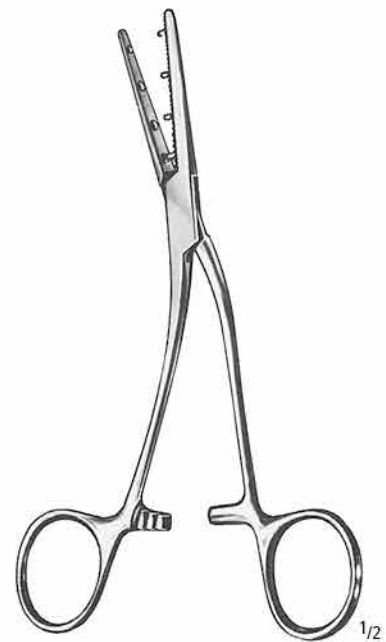

**MASTIN**  
**KL 245/17**  
 17,0 cm/6<sup>3</sup>/<sub>4</sub>"

TONSILLEN TONSILS AMIGDALAS AMYGDALES TONSILLE

Tonsillennesser  
Tonsil Knives  
Bisturías para amígdalas  
Bistouris pour amygdales  
Bisturi per tonsille



**FISCHER**  
**KL 247/22**  
22,5 cm/9"



**ABRAHAM**  
**KL 248/19**  
19,0 cm/7 1/2"



**ABRAHAM**  
**KL 248/21**  
21,0 cm/8 1/4"



**CANFIELD**  
**KL 249/21**  
21,0 cm/8 1/4"



**BRUENINGS**  
**KL 250/23**  
23,0 cm/9"



**DOUGLAS**  
**KL 251/21**  
21,0 cm/8 1/4"



**CARPENTER**  
**KL 252/25**  
25,0 cm/10"

AA  
AB  
AC  
AD  
AE  
AF  
AK  
AL  
AO  
AP  
AR  
KA  
KL  
KM  
KO  
KU  
KYE  
X

**KL** TONSILLEN TONSILS AMIGDALAS AMYGDALES TONSILLE

Dissektoren  
Dissectors  
Disecadores  
Dissecteurs  
Dissettori

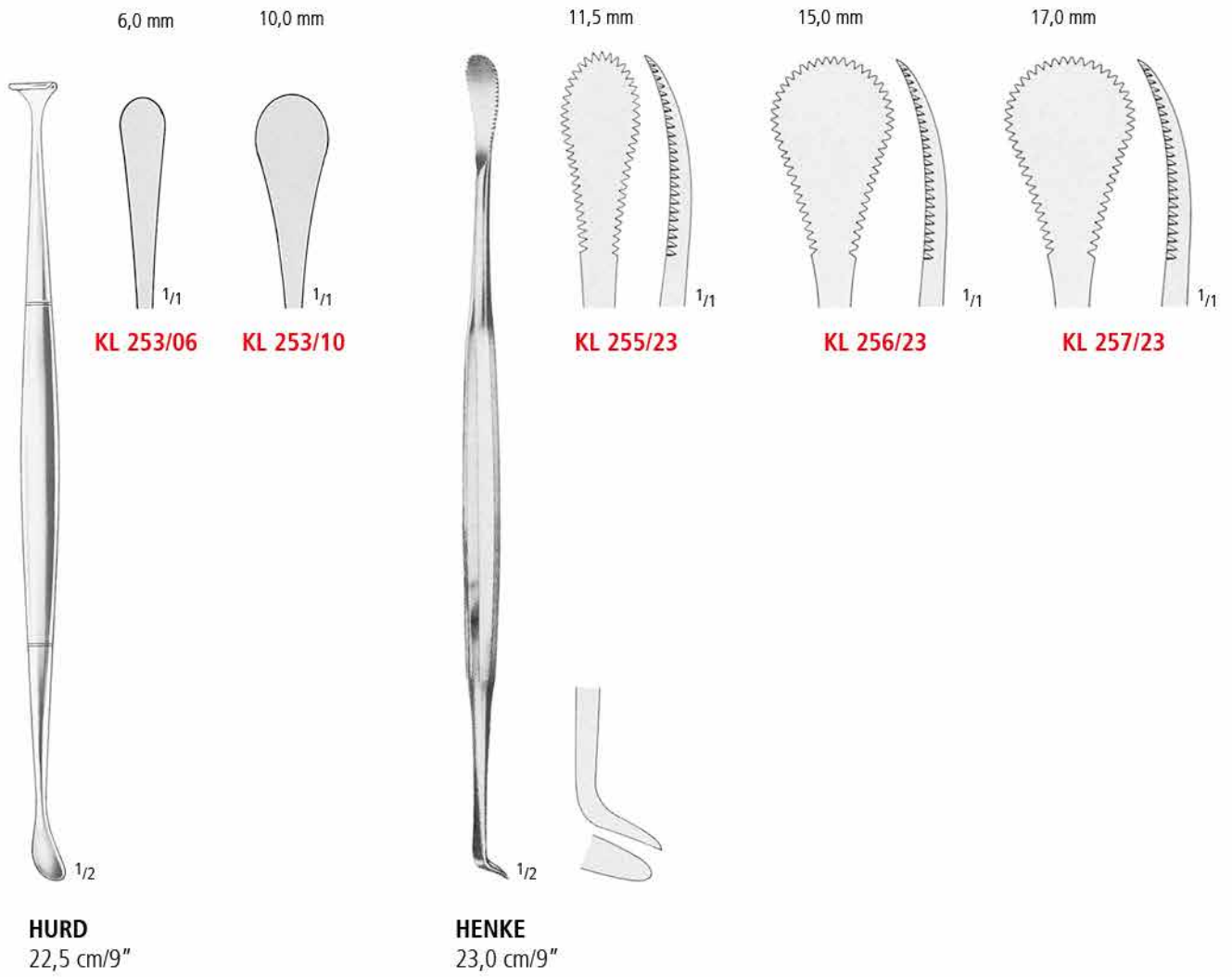



TONSILLEN TONSILS AMIGDALAS AMYGDALES TONSILLE

Dissektoren  
Dissectors  
Disecadores  
Dissecteurs  
Dissettori

AA  
AB  
AC  
AD  
AE  
AF  
AK  
AL  
AO  
AP  
AR  
KA  
KL  
KM  
KO  
KU  
KYE  
X



**WÜRZBURG**  
**KL 259/21**  
21,0 cm/8<sup>1</sup>/<sub>4</sub>"



**MOLLISON**  
**KL 260/21**  
21,0 cm/ 8<sup>1</sup>/<sub>4</sub>"



**LUNIATSCHECK**  
**KL 262/19**  
19,0 cm/7<sup>1</sup>/<sub>2</sub>"

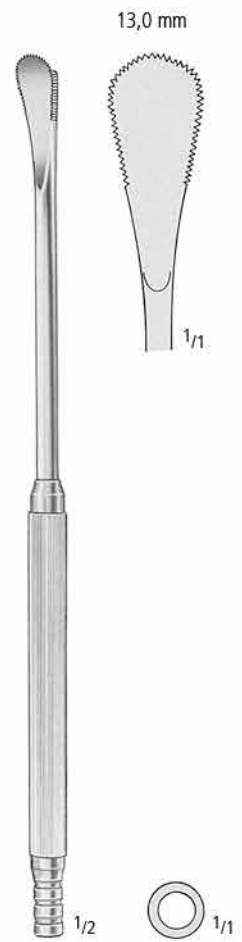

**LOPEZ-REINKE**  
**KL 264/23**  
23,5 cm/9<sup>1</sup>/<sub>3</sub>"

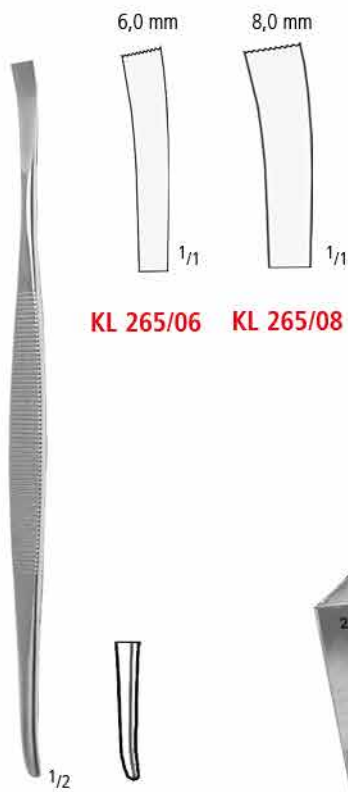

**KL 265/06** **KL 265/08**

**GWYNNE**  
20,0 cm/8"



**MARLIN**  
**KL 266/01**

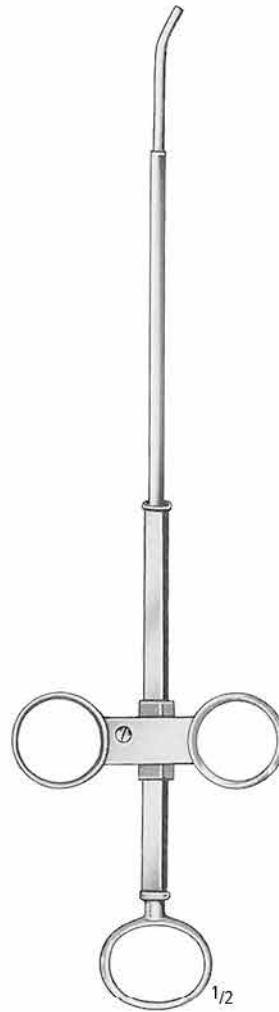

**RÖDER**  
**KL 266/26**  
26,5 cm/10 1/2"



**MARSCHIK**  
**KL 267/22**  
22,0 cm/8 3/4"

TONSILLEN TONSILS AMIGDALAS AMYGDALES TONSILLE

Tonsillenretractoren, Tonsillennadeln  
 Tonsil retractors, Tonsil Needles  
 Separadores para Amígdalas, Agujas para Amígdalas  
 Ecarteurs per Amygdales, Aiguilles per Amygdales  
 Devaricatori per Tonsille, Aghi per Tonsille



**HOFER**  
**KL 268/24**  
 24,0 cm/9<sup>1</sup>/<sub>2</sub>"



**NAGER**  
**KL 269/23**  
 23,0 cm/9"



**DUPUY WEISS**  
**KL 274/01**  
 22,0 cm/8<sup>3</sup>/<sub>4</sub>"



**DUPUY WEISS**  
**KL 274/02**  
 22,0 cm/8<sup>3</sup>/<sub>4</sub>"

AA  
 AB  
 AC  
 AD  
 AE  
 AF  
 AK  
 AL  
 AO  
 AP  
 AR  
 KA  
**KL**  
 KM  
 KO  
 KU  
 KYE  
 X

**KL** TONSILLEN TONSILS AMIGDALAS AMYGDALES TONSILLE

Tonsillenzangen  
Tonsil Forceps  
Pinzas para las amígdalas  
Pincès pour amygdales  
Pinze per tonsille



**WHITE**  
**KL 276/18** 18,0 cm/7"  
**KL 276/23** 23,0 cm/9"



**BALLENGER 3:3**  
**KL 277/21** 21,5 cm/8½"

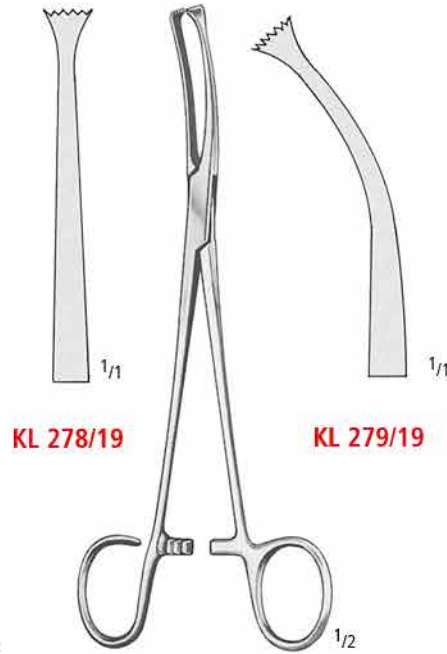

**KL 278/19** **KL 279/19**

**COLVER**  
19,0 cm/7½"

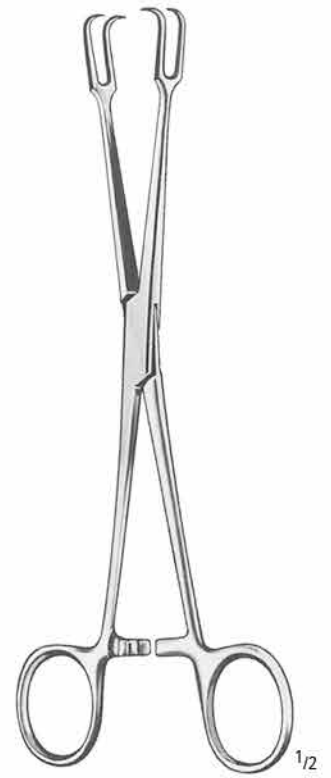

**MUSEUX**  
**KL 280/20** 20,0 cm/8"



**BLOHMKE**  
**KL 281/20** 20,0 cm/8"



**TIVNEN**  
**KL 283/21** 21,0 cm/8¼"



**TYDING**  
**KL 284/21** 21,0 cm/8¼"



**MARSCHIK-KRONE 3:3**  
**KL 285/21** 20,5 cm/8⅛"

TONSILLEN TONSILS AMIGDALAS AMYGDALES TONSILLE

Tonsillotom, Tonsillenanülen  
 Tonsillectome, Tonsil Cannula  
 Amígdalótomo, Canula para las amígdalas  
 Amygdalotome, Canule pour amygdales  
 Tonsillotomo, Cannula per tonsille



**KL 291/01**

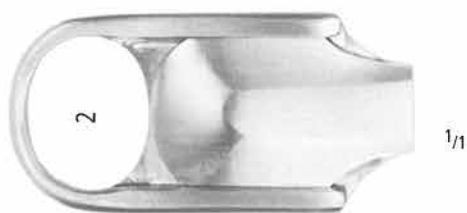

**KL 291/02**



**KL 291/03**

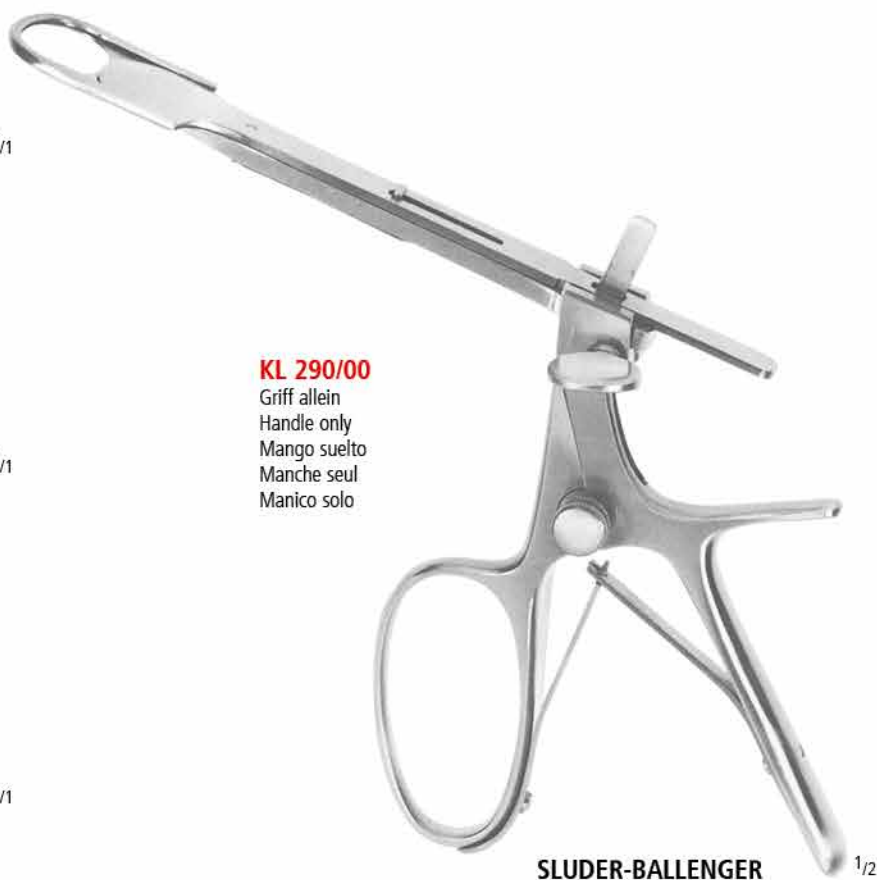

**KL 290/00**

Griff allein  
 Handle only  
 Mango suelto  
 Manche seul  
 Manico solo

**SLUDER-BALLENGER**

**KL 290/03**

komplett mit 3 Aufsätzen  
 complete with 3 tips  
 completo con 3 puntas  
 complet avec 3 lames  
 completo di 3 lame

0°

45°

90°



**KL 296/01**  
 Ø 0,8mm

**KL 296/02**  
 Ø 0,8mm

**KL 296/03**  
 Ø 0,8mm

Sauginstrumente, Spritzen siehe Gruppe AO  
 More suction instruments, Syringes in chapter AO  
 Para otras Tubos de aspiración, Jeringas ver sección AO  
 D'autres canules d'aspiration, Seringues groupe AO  
 Altre cannule per aspirazione, Siringhe vedi gruppo AO

AA  
 AB  
 AC  
 AD  
 AE  
 AF  
 AK  
 AL  
 AO  
 AP  
 AR  
 KA  
 KL  
 KM  
 KO  
 KU  
 KYE  
 X



**KL** TONSILLEN TONSILS AMIGDALAS AMYGDALES TONSILLE

Tonsillenschnürer  
Tonsil Snares  
Cierra-nudos para amígdalas  
Serre-nœuds pour l'ablation des amygdales  
Serranodi per tonsille



**EVES**  
**KL 300/28**  
28,0 cm/11"



**EVES**  
**KL 302/28**  
28,0 cm/11"

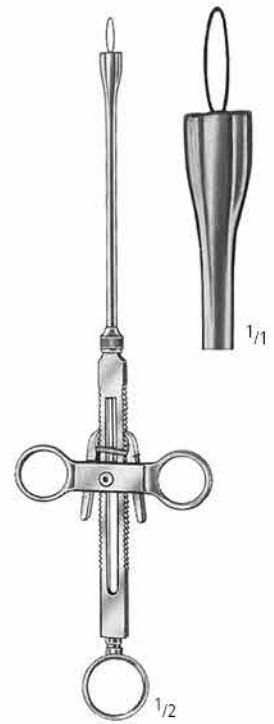

**BRUENINGS**  
**KL 306/28**  
28,0 cm/11"

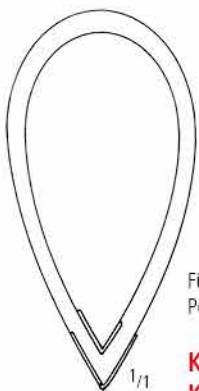

Für - For - Para -  
Pour - Per

**KL 300/28**  
**KL 302/28**  
**KL 314/01**

Packung 100 Stück  
Pack of 100 pcs.  
Paquete de 100 unidades  
en paquets de 100 pièces  
pacco di 100 pezzi

**KL 310/40** = 40 mm  
**KL 310/50** = 50 mm



Für - For - Para -  
Pour - Per

**KL 306/28**

Packung 12 Stück  
Pack of 12 pcs.  
Paquete de 12 unidades  
en paquets de 12 pièces  
pacco di 12 pezzi

**KL 311/03** = 0,3 mm

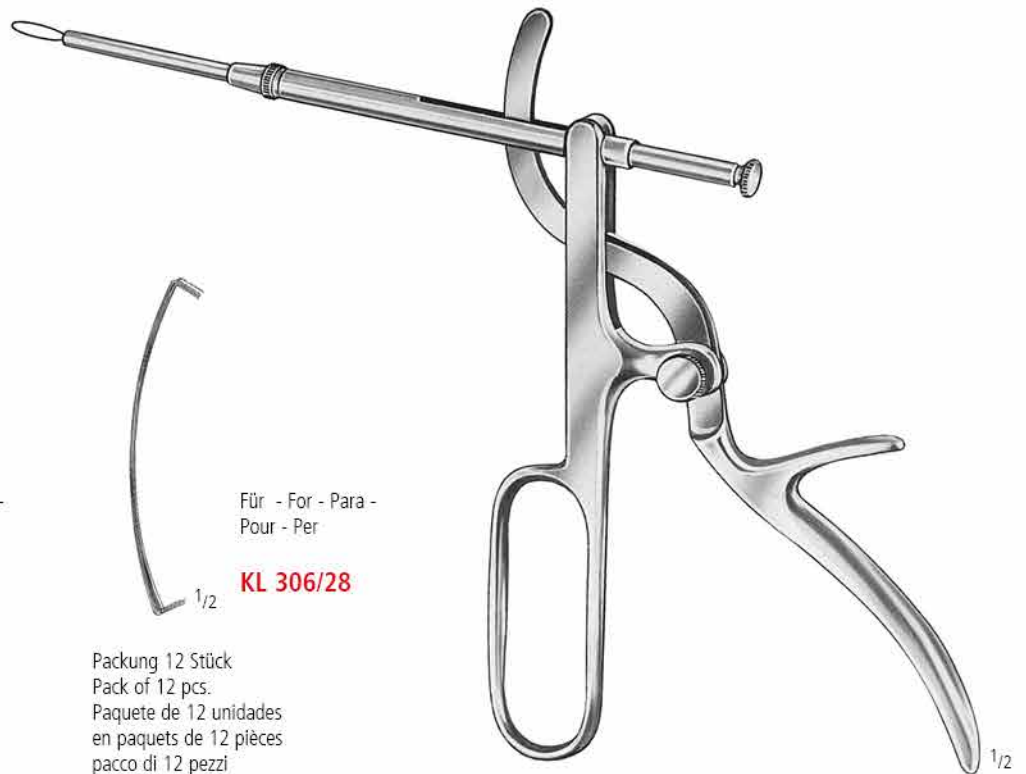

**TYDING**  
**KL 314/01**

TONSILLEN TONSILS AMIGDALAS AMYGDALES TONSILLE

Scharfe Tonsillenzangen  
 Tonsil Punches  
 Pinzas cortantes para amígdalas  
 Pincas emporte-pièces pour amygdales  
 Pinze tagliente per tonsille

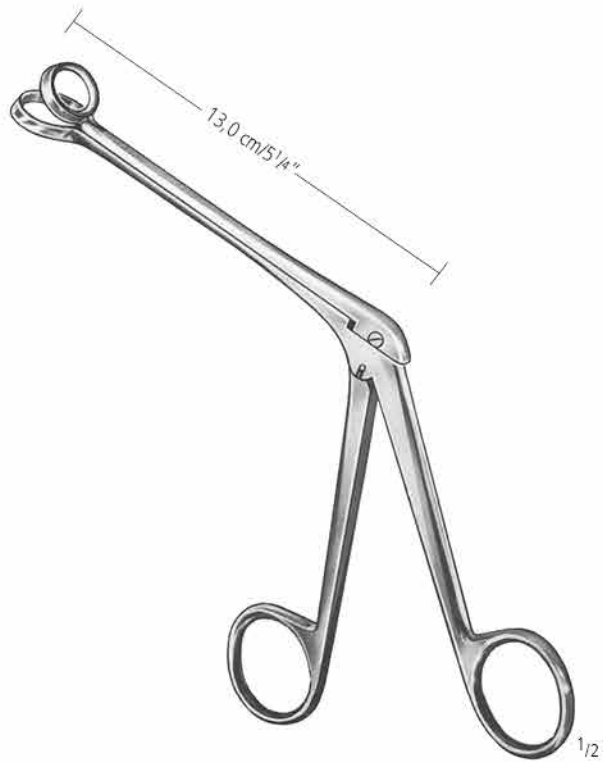
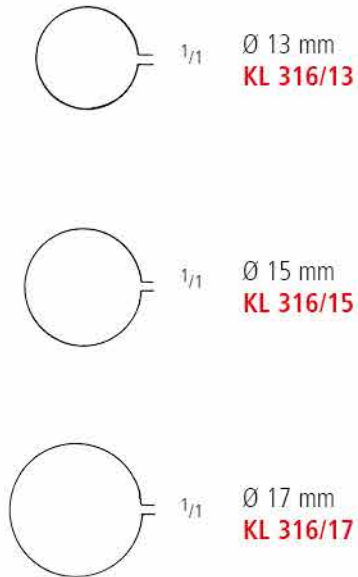

**HARTMANN**



**SCHMEDEN**

AA  
 AB  
 AC  
 AD  
 AE  
 AF  
 AK  
 AL  
 AO  
 AP  
 AR  
 KA  
 KM  
 KO  
 KU  
 KYE  
 X

**KL**

Universalgriffe und Aufsätze  
 Universal handles and tips  
 Mangos universales y pinzas intercambiables  
 Manches universels et pinces interchangeables  
 Manici universali e pinze intercambiabili



**HUBER**  
**KL 360/00**



**BRUENINGS**  
 20,0 cm/8" **KL 364/20**  
 30,0 cm/12" **KL 364/30**  
 40,0 cm/16" **KL 364/40**  
 50,0 cm/20" **KL 364/50**  
 60,0 cm/24" **KL 364/60**



**KL 365/20**

**BRUENINGS**  
 20,0 cm/8"

**KL 366/20**

starr  
 rigid  
 rigida  
 rigide  
 rigida

biegsam  
 malleable  
 flexible  
 flexible  
 flessibile

Universalgriffe und Aufsätze  
 Universal handles and tips  
 Mangos universales y pinzas intercambiables  
 Manches universels et pinces interchangeables  
 Manici universali e pinze intercambiabili

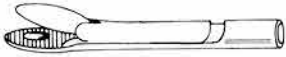

**FRAENKEL**

**KL 400/00**



**SEIFFERT**

**KL 402/00**

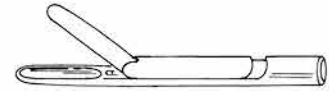

**FRAENKEL**

**KL 403/00**

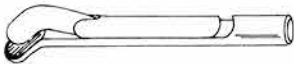

**SCHEINMANN**

**KL 404/00**

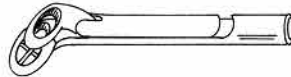

**SCHEINMANN**



**KL 405/00**



**BRUENINGS**



**KL 406/02**



**KL 406/03**



**KL 406/04**



**BRUENINGS**



**KL 407/00**



**KL 407/01**



**LANGE**

**KL 408/00**

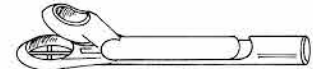

**KRAUSE**



**KL 409/00**



**KL 409/01**

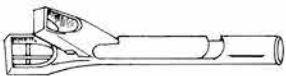

**KRAUSE**



**KL 410/00**



**CORDES**

**KL 411/01**



**KL 411/02**



**KL 411/03**



**KL 411/04**



**SCHUMACHER**



**KL 412/00**



**CORDES**



**KL 413/01**



**KL 413/02**

AA  
AB  
AC  
AD  
AE  
AF  
AK  
AL  
AO  
AP  
AR  
KA  
KL  
KM  
KO  
KU  
KYE  
X



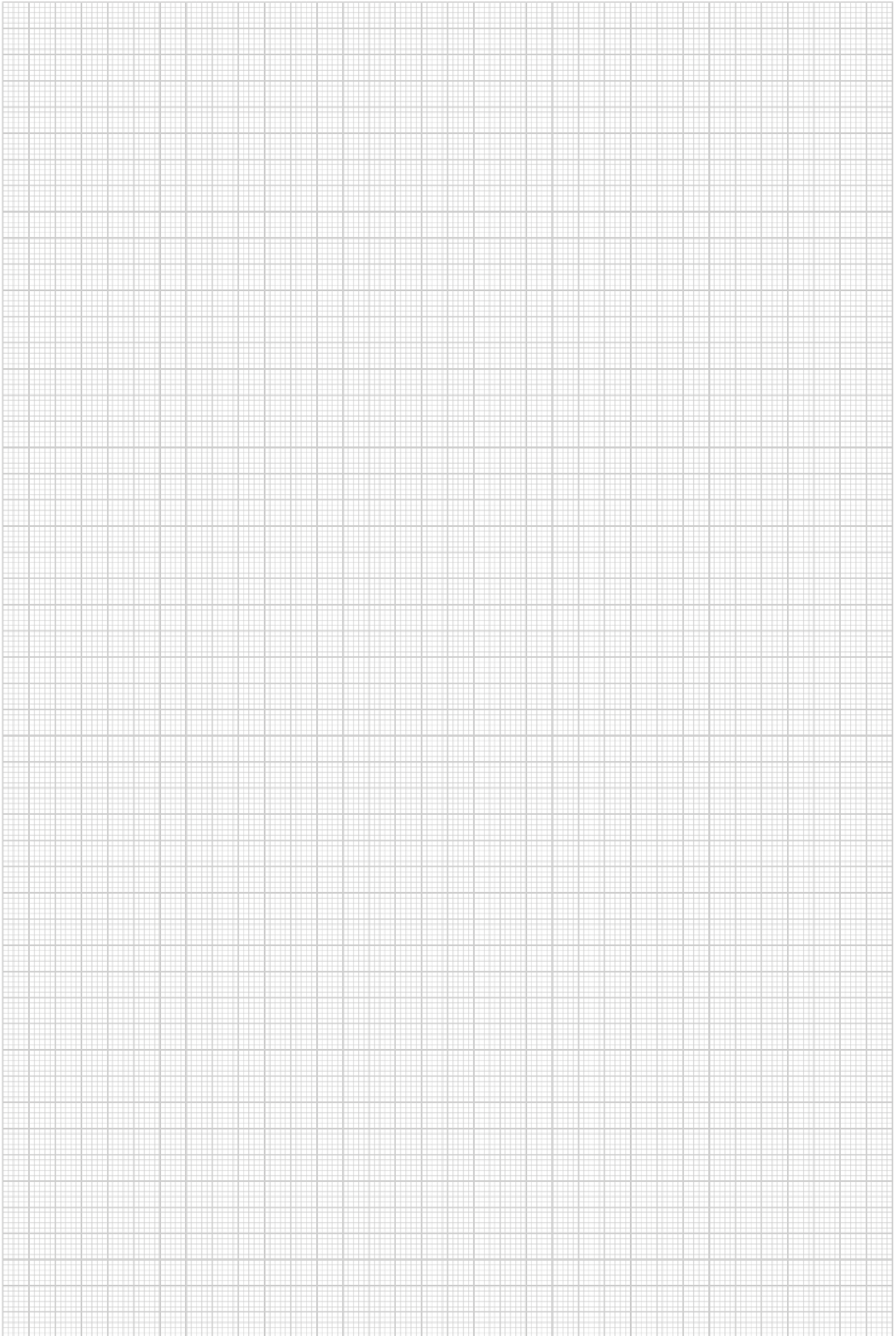



Endolaryngeale Mikrochirurgie  
 Endolaryngeal Micro-Surgery  
 Microcirugia Endolaríngea  
 Endolaryngeal micro-chirurgie  
 Microchirurgia Endolaríngea

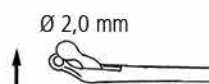
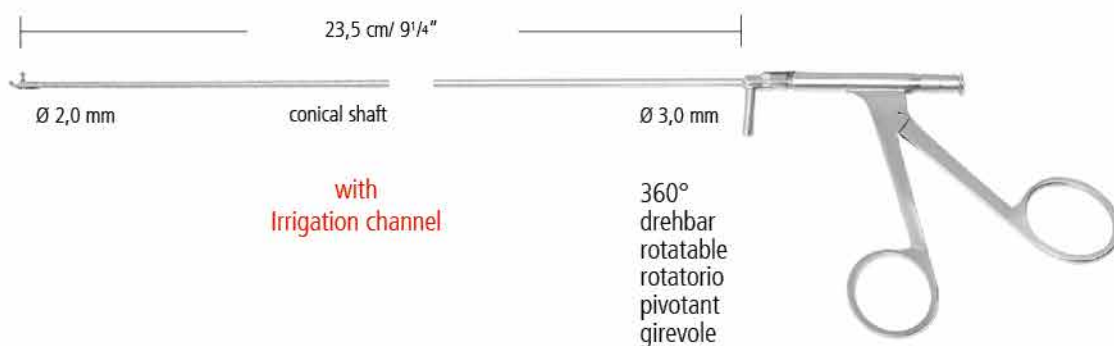

**KL 435/10**

aufgebogen - curved up - curvo hacia arriba - courbe vers le haut - curva in alto



**KL 435/30**

aufgebogen - curved up - curvo hacia arriba - courbe vers le haut - curva in alto



**KL 435/50**

Herzform aufgebogen - heart shape curved up - cordiforme curvo hacia arriba - forme de coeur courbe vers le haut - cuoriforme curva in alto



**KL 435/70**

aufgebogen - curved up - curvo hacia arriba - courbe vers le haut - curva in alto

AA  
AB  
AC  
AD  
AE  
AF  
AK  
AL  
AO  
AP  
AR  
KA  
KL  
KM  
KO  
KU  
KYE  
X

Endolaryngeale Mikrochirurgie  
 Endolaryngeal Micro-Surgery  
 Microcirugía Endolaríngea  
 Endolaryngeal micro-chirurgie  
 Microchirurgia Endolaríngea

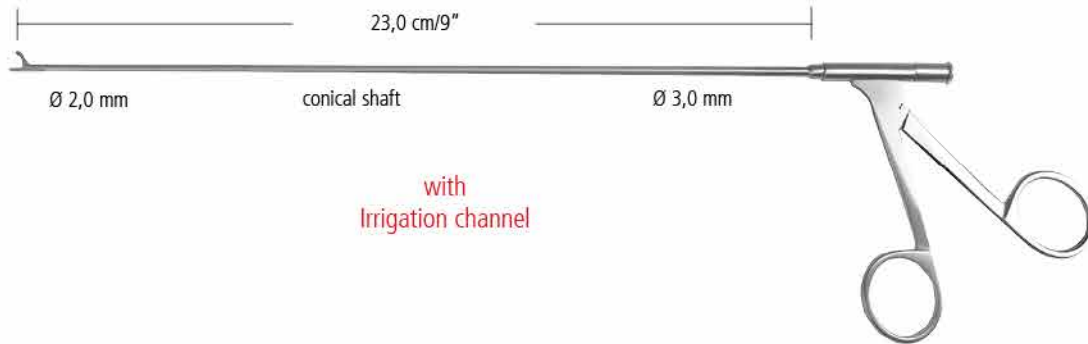

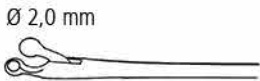

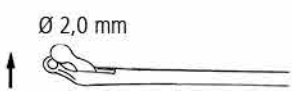
- 

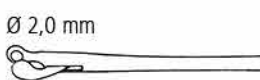
**KL 438/00**  
 gerade - straight - rectas - droits - rette
- 

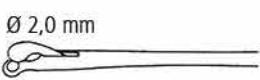
**KL 438/01**  
 aufgebogen - curved up - curvo arriba - courbe vers le haut - curva in alto
- 

**KL 438/02**  
 rechts - right - a la derecha - à droite - a destra
- 

**KL 438/03**  
 links - left - a la izquierda - à gauche - a sinistra
- 

**KL 438/04**  
 aufgebogen 45° rechts - curved up 45° right - arriba 45° a derecha -  
 courbe vers le haut 45° à droite - alto 45° a destra
- 

**KL 438/05**  
 Ø 2,0 mm - aufgebogen 45° links - curved up 45° left - arriba 45° a izquierda -  
 courbe vers le haut 45° à gauche - alto 45° a sinistra
- 

**KL 438/06**  
 oval 2,5 x 5,0 mm - mit Fenster aufgebogen - with window curved up -  
 con ventana curvado hacia arriba - avec fenetre courbe vers le haut - con finestra curva in alto
- 

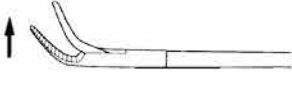
**KL 438/40**  
 gerade - straight - rectas - droits - rette
- 

**KL 438/41**  
 aufgebogen - curved up - curvo arriba - courbe vers le haut - curva in alto
- 

**KL 438/42**  
 rechts - right - a la derecha - à droite - a destra
- 

**KL 438/43**  
 links - left - a la izquierda - à gauche - a sinistra

Endolaryngeale Mikrochirurgie  
 Endolaryngeal Micro-Surgery  
 Microcirugía Endolaríngea  
 Endolaryngeal micro-chirurgie  
 Microchirurgia Endolaríngea

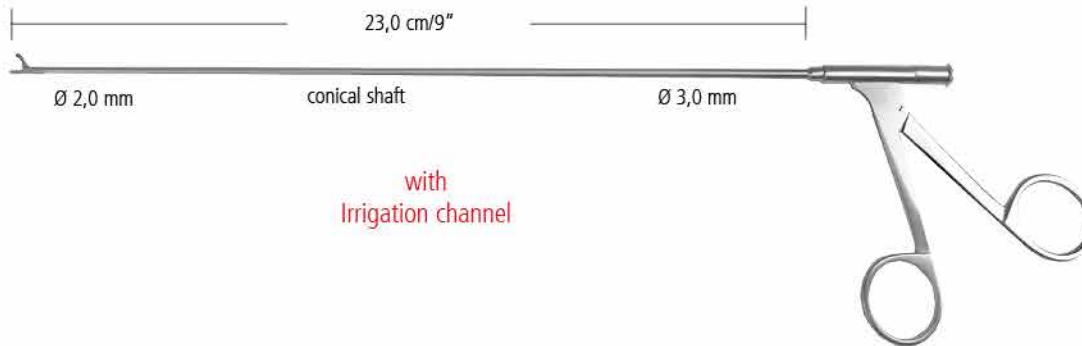

**KL 438/44**

Herzform gerade - heart shape straight - cordiforme droits - forme de coeur droit - cuoriforme retta

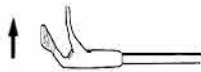

**KL 438/45**

Herzform aufgebogen - heart shape curved up - cordiforme curvo arriba - forme de coeur courbe vers le haut - cuoriforme curva in alto



**KL 438/46**

Herzform rechts - heart shape right - cordiforme a la derecha - forme de coeur à droite - cuoriforme a destra



**KL 438/47**

Herzform links - heart shape left - cordiforme a la izquierda - forme de coeur à gauche - cuoriforme a sinistra



**KL 438/80**

gerade - straight - rectas - droits - rette



**KL 438/81**

aufgebogen - curved up - curvo arriba - courbe vers le haut - curva in alto



**KL 438/82**

rechts - right - a la derecha - à droite - a destra

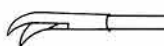

**KL 438/83**

links - left - a la izquierda - à gauche - a sinistra

AA  
AB  
AC  
AD  
AE  
AF  
AK  
AL  
AO  
AP  
AR  
KA  
KM  
KO  
KU  
KYE  
X

**KL**

Endolaryngeale Mikrochirurgie  
 Endolaryngeal Micro-Surgery  
 Microcirugía Endolaríngea  
 Endolaryngeal micro-chirurgie  
 Microchirurgia Endolaríngea

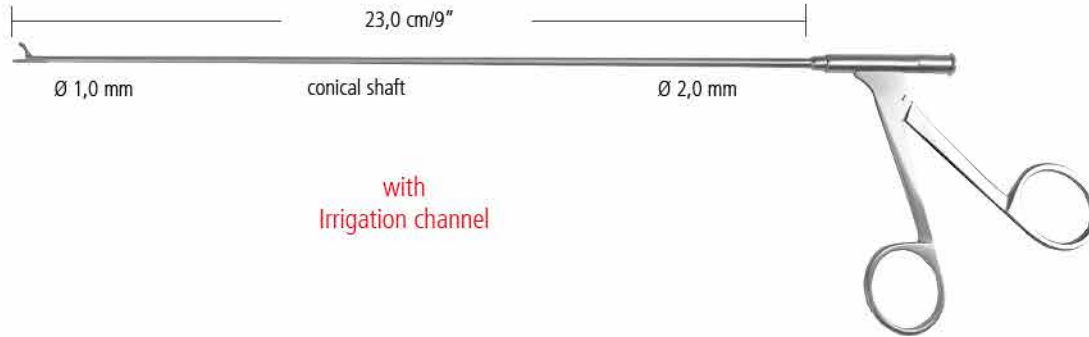

**KL 439/00**  
 gerade - straight - rectas - droits - rette

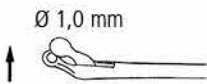

**KL 439/01**  
 aufgebogen - curved up - curvo arriba - courbe vers le haut - curva in alto

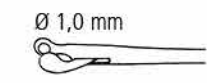

**KL 439/02**  
 rechts - right - a la derecha - à droite - a destra

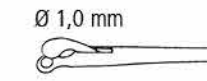

**KL 439/03**  
 links - left - a la izquierda - à gauche - a sinistra



**KL 439/40**  
 gerade - straight - rectas - droits - rette



**KL 439/42**  
 rechts - right - a la derecha - à droite - a destra



**KL 439/43**  
 links - left - a la izquierda - à gauche - a sinistra



**KL 439/48**  
 Herzform aufgebogen 45° rechts - heart shape curved up 45° right - cordiforme curvo arriba 45° a derecha -  
 forme de coeur courbe vers le haut 45° à droite - cuoriforme curvo in alto 45° a destra



**KL 439/49**  
 Herzform aufgebogen 45° links - heart shape curved up 45° left - cordiforme curvo arriba 45° a la izquierda -  
 forme de coeur courbe vers le haut 45° à gauche - cuoriforme curvo in alto 45° a sinistra

Endolaryngeale Mikrochirurgie  
 Endolaryngeal Micro-Surgery  
 Microcirugia Endolaríngea  
 Endolaryngeal micro-chirurgie  
 Microchirurgia Endolaríngea

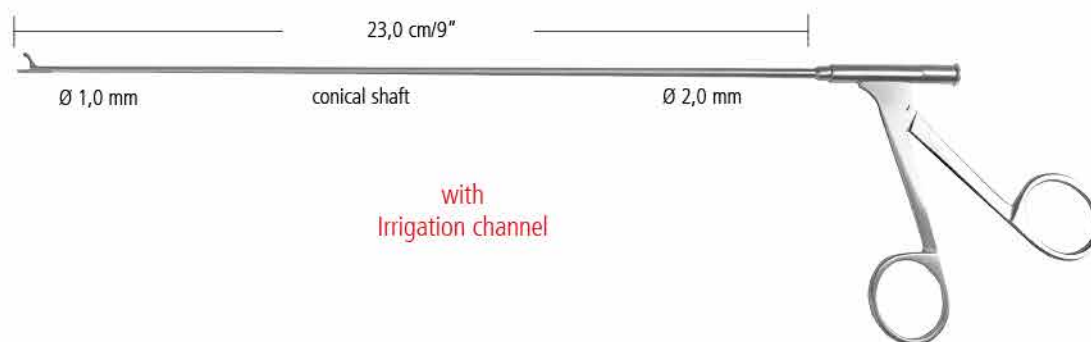

**KL 439/80**  
 gerade - straight - rectas - droits - rette



**KL 439/81**  
 aufgebogen - curved up - curvo arriba - courbe vers le haut - curva in alto

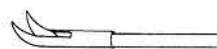

**KL 439/82**  
 rechts - right - a la derecha - à droite - a destra

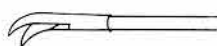

**KL 439/83**  
 links - left - a la izquierda - à gauche - a sinistra

AA  
 AB  
 AC  
 AD  
 AE  
 AF  
 AK  
 AL  
 AO  
 AP  
 AR  
 KA  
 KM  
 KO  
 KU  
 KYE  
 X

**KL**



Endolaryngeale Mikrochirurgie  
 Endolaryngeal Micro-Surgery  
 Microcirugía Endolaríngea  
 Endolaryngeal micro-chirurgie  
 Microchirurgia Endolaríngea

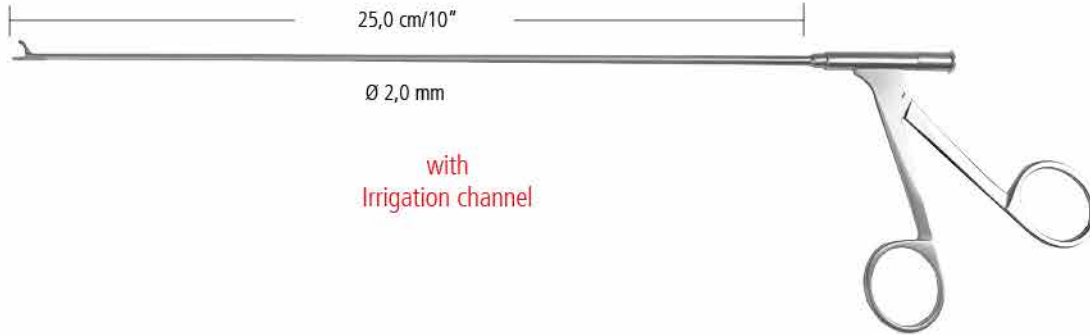

**KL 440/00**  
 gerade - straight - rectas - droits - rette

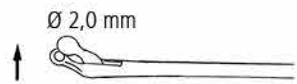

**KL 440/01**  
 aufgebogen - curved up - curvo arriba - courbe vers le haut - curva in alto

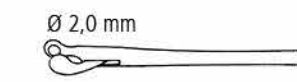

**KL 440/02**  
 rechts - right - a la derecha - à droite - a destra

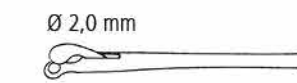

**KL 440/03**  
 links - left - a la izquierda - à gauche - a sinistra



**KL 441/00**  
 gerade - straight - rectas - droits - rette



**KL 441/01**  
 rechts - right - a la derecha - à droite - a destra



**KL 441/02**  
 links - left - a la izquierda - à gauche - a sinistra



**KL 443/00**  
 gerade - straight - rectas - droits - rette



**KL 443/01**  
 aufgebogen - curved up - curvo arriba - courbe vers le haut - curva in alto

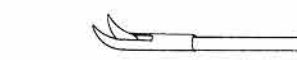

**KL 443/02**  
 rechts - right - a la derecha - à droite - a destra



**KL 443/04**  
 links - left - a la izquierda - à gauche - a sinistra

Endolaryngeale Mikrochirurgie  
 Endolaryngeal Micro-Surgery  
 Microcirugía Endolaríngea  
 Endolaryngeal micro-chirurgie  
 Microchirurgia Endolaríngea

Kinder  
 Children  
 Niños  
 Enfants  
 Bambini

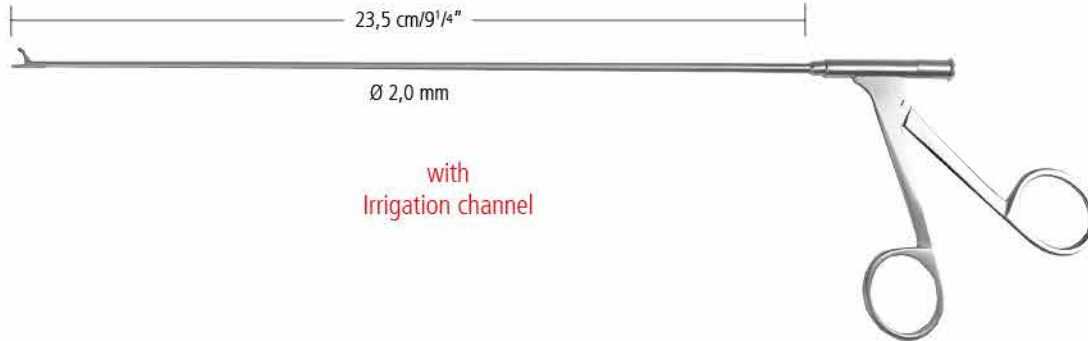

**KL 444/00**  
 gerade - straight - rectas - droits - rette

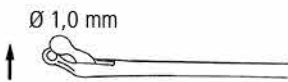

**KL 444/01**  
 aufgebogen - curved up - curvo arriba - courbe vers le haut - curva in alto

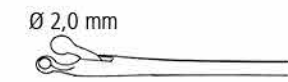

**KL 444/20**  
 gerade - straight - rectas - droits - rette

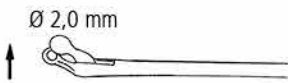

**KL 444/21**  
 aufgebogen - curved up - curvo arriba - courbe vers le haut - curva in alto



**KL 444/80**  
 gerade - straight - rectas - droits - rette

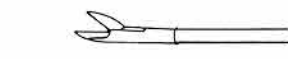

**KL 445/00**  
 gerade - straight - rectas - droits - rette

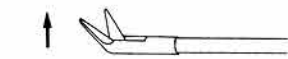

**KL 445/01**  
 aufgebogen - curved up - curvo arriba - courbe vers le haut - curva in alto



**KL 445/02**  
 rechts - right - a la derecha - à droite - a destra



**KL 445/03**  
 links - left - a la izquierda - à gauche - a sinistra

AA  
 AB  
 AC  
 AD  
 AE  
 AF  
 AK  
 AL  
 AO  
 AP  
 AR  
 KA  
 KL  
 KM  
 KO  
 KU  
 KYE  
 X

Endolaryngeale Mikrochirurgie  
 Endolaryngeal Micro-Surgery  
 Microcirugía Endolaríngea  
 Endolaryngeal micro-chirurgie  
 Microchirurgia Endolaríngea

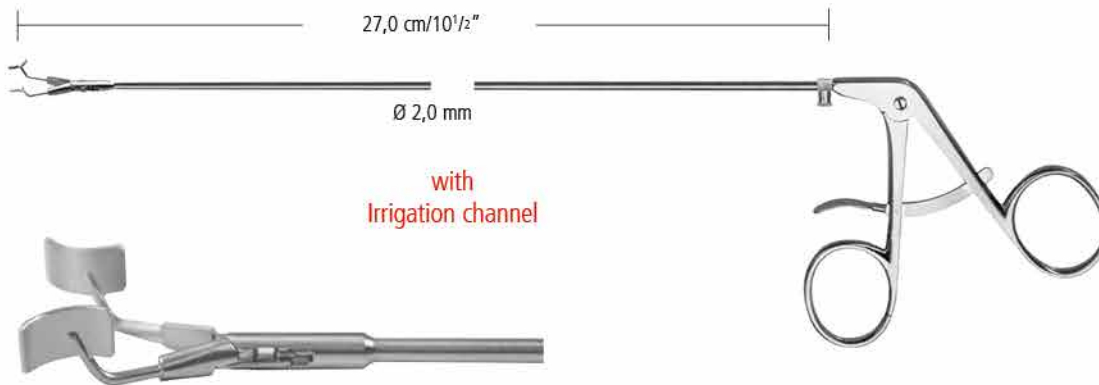

Stimmbandspreizer  
 Vocal cord spreader  
 Devaricatore per corde vocali  
 Ecarteur à cordes vocales  
 Separador cuerdas vocales

**KL 450/00**

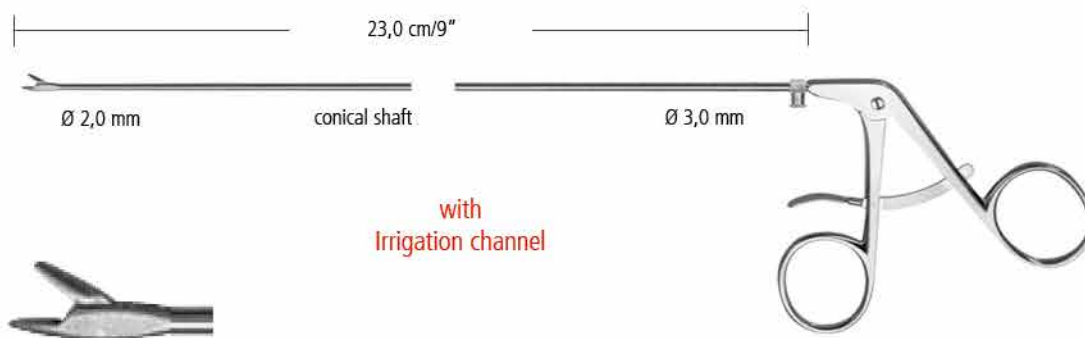

Nadelhalter  
 Needle holder  
 Portaghi  
 Porte aiguille  
 Porta-aguja

**KL 453/00**

LARYNGOLOGIE LARYNGOLOGY LARINGOLOGIA LARYNGOLOGIE LARINGOLOGIA

Zangen zur Laryngo-Bronchoskopie  
 Forceps for Laryngo-Bronchoscopy  
 Pinzas para Laringo-Broncoscopia  
 Pinces pour Laryngo-Bronchoscopie  
 Pinze per Laringo-Broncoscopia

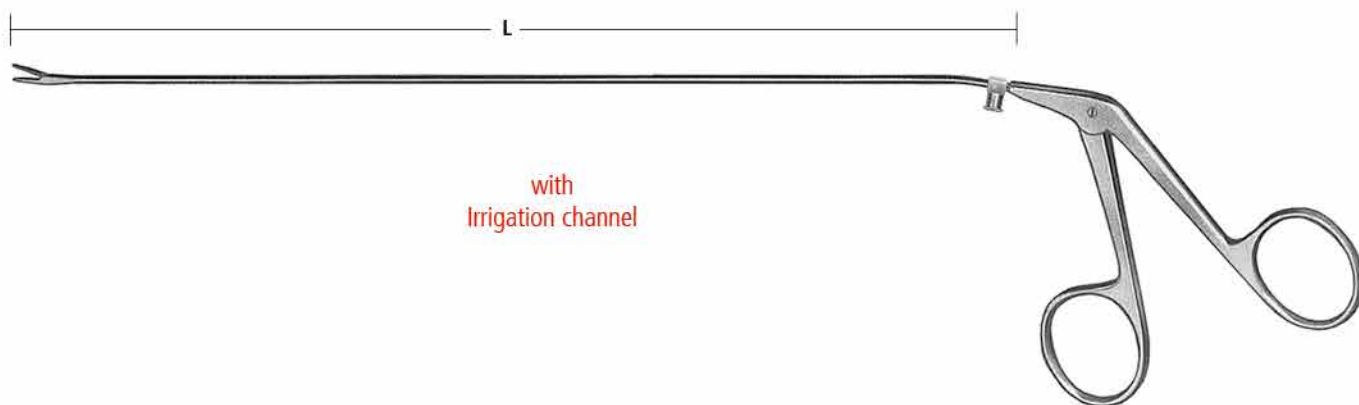

Ø 1,5 mm



L  
 30,0 cm/12"  
 35,0 cm/14"

**KL 460/30**  
**KL 460/35**

**KL 461/30**  
**KL 461/35**

**KL 462/30**  
**KL 462/35**

**KL 463/30**  
**KL 463/35**

Ø 2,5 mm



L  
 40,0 cm/16"  
 45,0 cm/18"  
 50,0 cm/20"  
 55,0 cm/22"  
 60,0 cm/24"

**KL 460/40**  
**KL 460/45**  
**KL 460/50**  
**KL 460/55**  
**KL 460/60**

**KL 461/40**  
**KL 461/45**  
**KL 461/50**  
**KL 461/55**  
**KL 461/60**

**KL 462/40**  
**KL 462/45**  
**KL 462/50**  
**KL 462/55**  
**KL 462/60**

**KL 463/40**  
**KL 463/45**  
**KL 463/50**  
**KL 463/55**  
**KL 463/60**

AA  
 AB  
 AC  
 AD  
 AE  
 AF  
 AK  
 AL  
 AO  
 AP  
 AR  
 KA  
 KL  
 KM  
 KO  
 KU  
 KYE  
 X

**KL** MUND MOUTH BOCA BOUCHE BOCCA

Mundspiegelgriffe  
 Mouth mirror handles  
 Mangos para espejos de boca  
 Manches pour miroirs à bouche  
 Manici per specchietti



1/1

**SECCO**

**KL 506/01**  
 14,0 cm/5 1/2"



1/1

**KL 507/12**  
 12,0 cm/4 3/4"



1/1

**KL 508/12**  
 12,0 cm/4 3/4"  
 Ø 6,0 mm



1/1

**KL 509/14**  
 14,0 cm/5 1/2"  
 Ø 8,0 mm



1/1

**KL 509/24**  
 14,0 cm/5 1/2"  
 Ø 11,0 mm



1/1

**KL 510/12**  
 12,0 cm/4 3/4"



MUND MOUTH BOCA BOUCHE BOCCA

Mundspiegelansätze  
 Mouth mirrors  
 Espejos de boca  
 Mirrors à bouche  
 Specchietti



Verpackungseinheit / packing unit 12 St./pc.

Größe  
 Size  
 Tamaño  
 Taille  
 Dimens.  
 plan, metr. Gewinde  
 plane, metr. thread  
 plano, rosca métrica  
 plan, filetage métrique  
 piano, filettatura metrica

metr. Gewinde, hohl  
 metr. thread, concave  
 rosca métrica, cóncavo  
 filetage métrique, concave  
 filettatura metrica, cavo

Ø mm

22  
 24

4  
 5

**KL 511/04**  
**KL 511/05**

**KL 512/04**  
**KL 512/05**

**HILGER**  
**KL 513/02**

AA  
 AB  
 AC  
 AD  
 AE  
 AF  
 AK  
 AL  
 AO  
 AP  
 AR  
 KA  
 KL  
 KM  
 KO  
 KU  
 KYE  
 X

**KL** MUND MOUTH BOCA BOUCHE BOCCA

HD Ultra FS Mundspiegelansätze  
 HD Ultra FS Mouth mirrors  
 HD Ultra FS Espejos de boca  
 HD Ultra FS Mirrors à bouche  
 HD Ultra FS Specchietti



	HD ULTRA FS Mouth Mirrors		Size		QTY	REF
1	HD ULTRA FS	4	Ø 22mm	plane	box of 6	<b>KL 515/04</b>
	HD ULTRA FS	5	Ø 24mm	plane	box of 6	<b>KL 515/05</b>
2	HD ULTRAretract FS	4	Ø 22mm	plane	box of 6	<b>KL 517/04</b>
	HD ULTRAretract FS	5	Ø 24mm	plane	box of 6	<b>KL 517/05</b>
3	HD ULTRAretract FS, bifurcated stem	4	Ø 22mm	plane	box of 6	<b>KL 518/04</b>
	HD ULTRAretract FS, bifurcated stem	5	Ø 24mm	plane	box of 6	<b>KL 518/05</b>
4	HD ULTRA FS, bifurcated stem stem double 45°	4	Ø 22 mm	plane	each	<b>KL 518/34</b>
5	HD ULTRAduo, double side in front and behind	4	Ø 22 mm	plane	box of 6	<b>KL 518/44</b>
	HD ULTRAduo, double side in front and behind	5	Ø 24 mm	plane	box of 6	<b>KL 518/45</b>
6	HD ULTRAmicro	mini mirror	Ø 3 mm		each	<b>KL 518/53</b>
	HD ULTRAmicro	mini mirror	Ø 5 mm		each	<b>KL 518/55</b>
	HD ULTRAmicro	mini mirror	3 x 6 mm		each	<b>KL 518/56</b>

only one reflection = exact sharp image

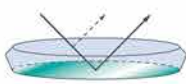

Front Surface Coating



The splitted mirror shows the crystal clear bright reflection of the HD ULTRA FS compared to Rhodium.

Kehlkopfspiegel  
Laryngeal Mirrors  
Espejos laringeos  
Miroirs laryngiens  
Specchi laringei



Fig. 00



Fig. 0



Fig. 1



Fig. 2

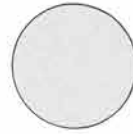

Fig. 3

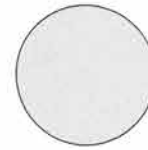

Fig. 4

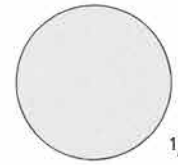

Fig. 5

1/n

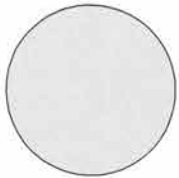

Fig. 6

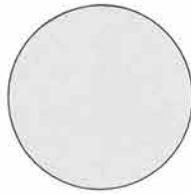

Fig. 7

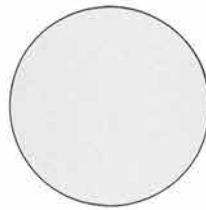

Fig. 8

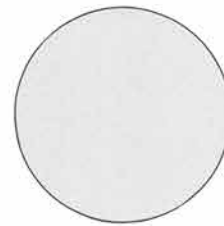

Fig. 9

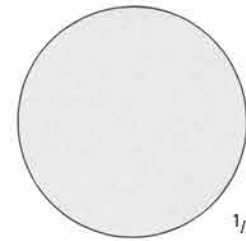

Fig. 10

1/n



1/2

KL 500/10



1/2

- KL 520/08
- KL 520/10
- KL 520/12
- KL 520/14
- KL 520/16
- KL 520/18
- KL 520/20
- KL 520/22
- KL 520/24
- KL 520/26
- KL 520/28
- KL 520/30

Fig.

mm Ø

- 00
- 0
- 1
- 2
- 3
- 4
- 5
- 6
- 7
- 8
- 9
- 10

- 8
- 10
- 12
- 14
- 16
- 18
- 20
- 22
- 24
- 26
- 28
- 30



1/2

- KL 522/08
- KL 522/10
- KL 522/12
- KL 522/14
- KL 522/16
- KL 522/18
- KL 522/20
- KL 522/22
- KL 522/24
- KL 522/26
- KL 522/28
- KL 522/30

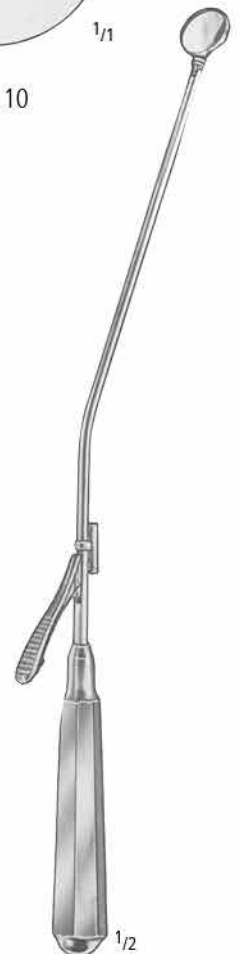

1/2

MICHEL

- KL 524/12
- KL 524/14
- KL 524/16
- KL 524/18

AA  
AB  
AC  
AD  
AE  
AF  
AK  
AL  
AO  
AP  
AR  
KA  
KM  
KO  
KU  
KYE  
X

KL

Postrinoskopie-Spiegel, Kehlkopfzangen  
 Mirror Post-Rhinoscopic, Laryngeal Forceps  
 Espejo postrinosópico, Pinzas para laringeos  
 Miroir postrinoscopique, Pincès à laryngiens  
 Specchio postrinoscopico, Pinze per laringei



1/2



**KL 550/00**  
 Spiegel/Endoskopwärmer  
 Mirror/Endoscop Heater

**ST. CLAIRE THOMSON**

18,0 cm/7"

8,0 mm

**KL 526/08**

10,0 mm

**KL 526/10**

12,0 mm

**KL 526/12**

14,0 mm

**KL 526/14**

16,0 mm

**KL 526/16**

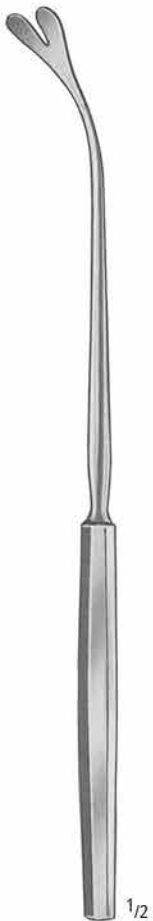

1/2



1/2

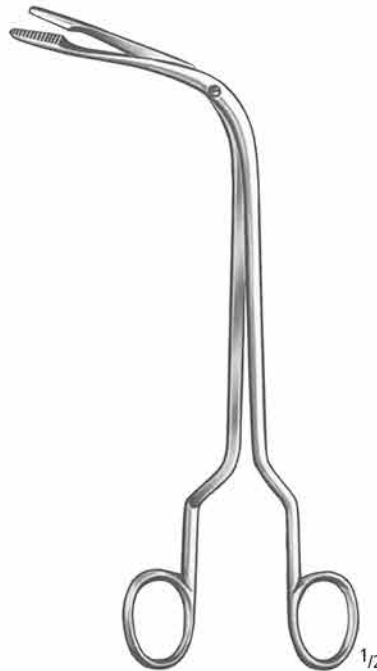

1/2

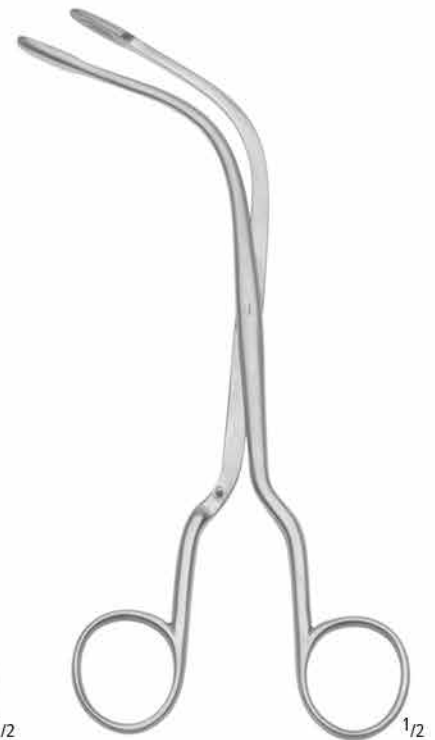

1/2

**REICHERT**  
**KL 590/24**  
 24,0 cm/9 1/2"

**KILLIAN**  
**KL 594/20**  
 20,0 cm/8"

**FRAENKEL**  
**KL 601/18**  
 18,0 cm/7"

**FRAENKEL**  
**KL 603/19**  
 19,0 cm/7 1/2"

Kehlkopfpolypenzangen  
Laryngeal Polypus Forceps  
Pinzas para pólipos laríngeos  
Pincas à polypes laryngiens  
Pinze per polipi laringei

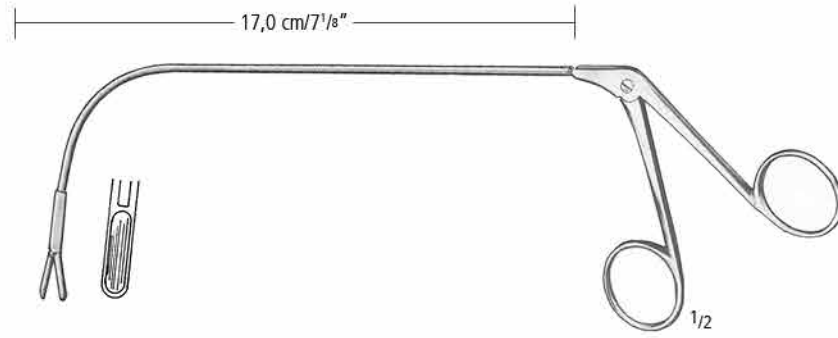

Without irrigation channel

**KL 613/00**

**FRAENKEL**  
26,5 cm/10 1/2"

With irrigation channel  
on request

**KL 613/10**

**KL 613/11**

vertikal  
vertical  
vertical  
vertical  
verticale

horizontal  
horizontal  
horizontal  
horizontal  
orizzontale

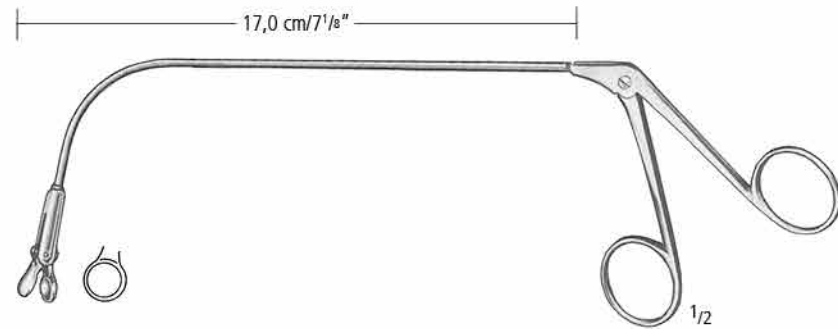

Without irrigation channel

**KL 614/00**

**KL 614/01**

**KL 614/02**

**KL 614/03**

**LANGE**  
26,5 cm/10 1/2"

With irrigation channel  
on request

**KL 614/11**

**KL 614/12**

**KL 614/13**

gerade  
straight  
rectas  
droits  
rette

aufgebogen  
curved up  
curvo arriba  
courbe vers le haut  
curva in alto

rechts  
right  
a la derecha  
à droite  
a destra

links  
left  
a la izquierda  
à gauche  
a sinistra

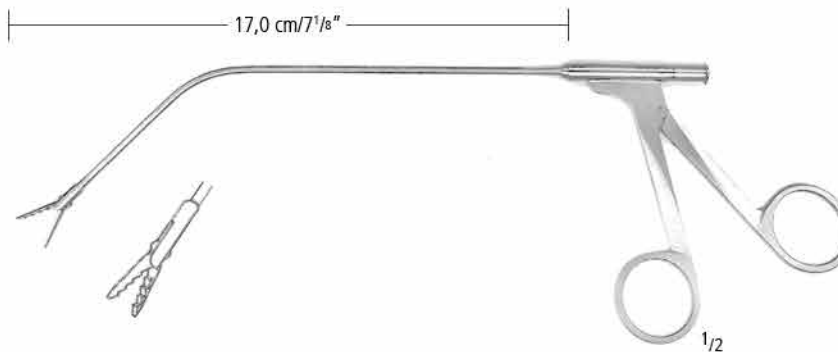

Without irrigation channel

**KL 615/00**

**ALLIGATOR**

With irrigation channel  
on request

**KL 615/10**

**KL 615/11**

vertikal  
vertical  
vertical  
vertical  
verticale

horizontal  
horizontal  
horizontal  
horizontal  
orizzontale

AA  
AB  
AC  
AD  
AE  
AF  
AK  
AL  
AO  
AP  
AR  
KA  
KL  
KM  
KO  
KU  
KYE  
X



**KL** SPEICHEL GANG DUCTUS SALIVATORY DUCTUS SALIVARIUS

Speichelgangsonden  
 Ductus salivatory Probes  
 Sondes exploratrices pour le ductus salivarius  
 Sondas exploradoras para ductus salivarius  
 Sonde esploratrici per ductus salivarius



geknöpft  
 pointed  
 con botón  
 boutoné  
 bottenuto

aus Silber  
 Sterling silver  
 de plata pura  
 en argent pur  
 in argento puro

- KP 114/00
- KP 115/00
- KP 115/01
- KP 115/12
- KP 115/23
- KP 115/34
- KP 115/45
- KP 115/56
- KP 115/67
- KP 115/78

Fig.	mm Ø
0000/00	0,4 / 0,6
00/0	0,7 / 0,8
0/1	0,8 / 0,9
1/2	0,9 / 1,1
2/3	1,1 / 1,3
3/4	1,3 / 1,4
4/5	1,4 / 1,5
5/6	1,5 / 1,6
6/7	1,6 / 1,8
7/8	1,8 / 1,9

zylindrisch  
 cylindrical  
 cilíndrica  
 cylindrique  
 cilindrico

- KP 116/00
- KP 117/00
- KP 117/01
- KP 117/12
- KP 117/23
- KP 117/34
- KP 117/45
- KP 117/56
- KP 117/67
- KP 117/78



**BOWMAN**  
 12,5 cm/5"

**BOWMAN**  
 12,5 cm/5"

aus Silber  
 Sterling silver  
 de plata pura  
 en argent pur  
 in argento puro



**PROBE FOR SALIVARY GLAND**

**KL 720/13**

13,0 cm/5"

Ø 1,4 mm

0,7 mm Loch - hole - agujero - trou - buco

SPEICHEL GANG DUCTUS SALIVARY DUCTUS SALIVARIUS

Speichelgangdilatoren  
 Ductus salivary Dilators  
 Dilateurs para ductus salivarius  
 Dilatadoras pour le ductus salivarius  
 Dilatori per ductus salivarius



1/1

**WILDER**  
 10,0 cm/4"



1/1

**KP 120/01**  
 Fig. 1



1/1

**KP 120/02**  
 Fig. 2

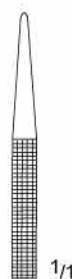

1/1

**KP 120/03**  
 Fig. 3



1/1

**MULDOON**  
**KP 121/11**  
 10,5 cm/4<sup>1</sup>/<sub>4</sub>"



1/1



1/1

**PERWITZSCHKY**  
**AC 403/11**  
 11,0 cm/4<sup>1</sup>/<sub>2</sub>"

Weitere Scheren siehe Gruppe AC  
 Further scissors see section AC  
 Otras tijeras cortantes ver seccion AC  
 D'autres ciseaux voir groupe AC  
 Altre forbici vedi gruppo AC

AA  
 AB  
 AC  
 AD  
 AE  
 AF  
 AK  
 AL  
 AO  
 AP  
 AR  
 KA  
 KM  
 KO  
 KU  
 KYE  
 X

**KL**



HNO  
ENT  
ORL

KM

nopa<sup>®</sup> instruments

Otologie  
Otology  
Otología  
Otologie  
Otologia

Seite 277-308  
Page 277-308  
Página 277-308  
Page 277-308  
Pagina 277-308



**KM** OHR OTOLGY OTOLOGIA OTOLOGIE OTOLOGIA

Ohrspekula  
Ear Specula  
Espéculos auriculares  
Spéculums auriculaires  
Specoli auricolari

Ø = Innendurchmesser  
inside diameter  
diámetro interior  
diamètre intérieur  
diámetro interno

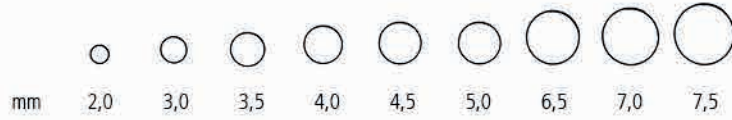

**KM 020/03**  
Set 1 - 3



für Kinder  
for children  
para niños  
pour enfants  
per bambini

**KM 030/03**  
Set 0 - 2



für Erwachsene  
for adults  
para adultos  
pour adultes  
per adulti

**KM 040/03**  
Set 2 - 4

**KM 040/04**  
Set 1 - 4

	POLITZER	HARTMANN	HARTMANN
mm			
2,0	<b>KM 021/01</b>		<b>KM 031/00</b>
3,0	<b>KM 021/02</b>		
3,5		<b>KM 031/01</b>	<b>KM 031/01</b>
4,0	<b>KM 021/03</b>		
5,0	<b>KM 021/04</b>	<b>KM 031/02</b>	<b>KM 031/02</b>
6,5			<b>KM 031/03</b>
7,5			<b>KM 031/04</b>



schwarz  
black  
negro  
noir  
nero

**KM 042/04**  
Set 0 - 3



**KM 044/03**  
Set 2 - 4

**KM 044/04**  
Set 1 - 4

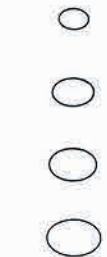

**KM 050/04**  
Set 1 - 4

	HARTMANN	TOYNBEE	GRUBER
mm			
3,0	<b>KM 041/00</b>		<b>KM 045/01</b>
4,0	<b>KM 041/01</b>		<b>KM 045/02</b>
4,5			<b>KM 051/01</b>
5,0	<b>KM 041/02</b>	<b>KM 045/03</b>	
5,5			<b>KM 051/02</b>
6,5		<b>KM 045/04</b>	<b>KM 051/03</b>
7,0	<b>KM 041/03</b>		<b>KM 051/04</b>



OHR OTOLGY OTOLOGIA OTOLOGIE OTOLOGIA

Ohrspekula  
Ear Specula  
Espéculos auriculares  
Spéculums auriculaires  
Specoli auricolari



**KM 056/01**  
3,5 mm



**KM 056/02**  
4,5 mm



**KM 056/03**  
5,5 mm



**KM 056/04**  
6,5 mm

**BOUCHERON**  
**KM 056/00**  
Set 1 - 4



20°



35°



**FARRIOR**



3,3 mm **KM 060/33**  
4,3 mm **KM 060/43**  
4,8 mm **KM 060/48**  
5,3 mm **KM 060/53**  
5,8 mm **KM 060/58**  
6,3 mm **KM 060/63**  
6,7 mm **KM 060/67**  
7,2 mm **KM 060/72**  
7,7 mm **KM 060/77**



3,0 x 4,0 mm **KM 062/30** **KM 063/30** **KM 064/30**  
4,0 x 5,0 mm **KM 062/40** **KM 063/40** **KM 064/40**  
4,5 x 5,5 mm **KM 062/45** **KM 063/45** **KM 064/45**  
5,0 x 6,0 mm **KM 062/50** **KM 063/50** **KM 064/50**  
5,5 x 6,5 mm **KM 062/55** **KM 063/55** **KM 064/55**  
6,0 x 7,0 mm **KM 062/60** **KM 063/60** **KM 064/60**  
6,5 x 7,5 mm **KM 062/65** **KM 063/65** **KM 064/65**  
7,0 x 8,0 mm **KM 062/70** **KM 063/70** **KM 064/70**  
7,5 x 8,5 mm **KM 062/75** **KM 063/75** **KM 064/75**

AA  
AB  
AC  
AD  
AE  
AF  
AK  
AL  
AO  
AP  
AR  
KA  
KL  
KM  
KO  
KU  
KYE  
X

Ohrspekula  
 Ear Specula  
 Espéculos auriculares  
 Spéculums auriculaires  
 Specoli auricolari



**BRUENINGS**

**KM 080/00**

komplett mit 4 Spekula Fig. 0 - 3  
 complete with 4 specula fig. 0 - 3  
 completo con 4 espéculos fig. 0 - 3  
 complet avec 4 spéculums fig. 0 - 3  
 completo con 4 specoli fig. 0 - 3

○	Fig. 00	<b>KM 081/01</b> 2,0/4,0 mm	
○	0	<b>KM 081/02</b> 3,0/4,8 mm	
○	1	<b>KM 082/01</b> 4,0/6,0 mm	
○	2	<b>KM 082/02</b> 5,0/7,0 mm	<b>KM 084/01</b> Saugkammer, allein Suction Head, only Cámara de aspiración, suelto Chambre aspiratrice, seule Camera aspirante, sola
○	3	<b>KM 082/03</b> 6,5/8,5 mm	
○	4	<b>KM 082/04</b> 8,5/10,5 mm	<b>KM 085/00</b> Gebläse, allein Rubbertube and bulb, only Insuflador de goma, suelto Soufflerie, seule Soffiera, sola
○	5	<b>KM 082/05</b> 10,5/12,5 mm	

für 12 Spekula  
 for 12 specula  
 para 12 espéculos  
 pour 12 spéculums  
 per 12 specoli

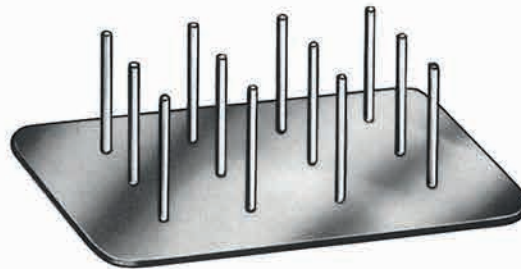

**KM 090/12**

Ohrspekula  
 Ear Specula  
 Espéculos auriculares  
 Spéculums auriculaires  
 Specoli auricolari

AA  
 AB  
 AC  
 AD  
 AE  
 AF  
 AK  
 AL  
 AO  
 AP  
 AR  
 KA  
 KL  
 KM  
 KO  
 KU  
 KYE  
 X



**SIEGLE**

**KM 092/00**

komplett  
 complete  
 completo  
 complet  
 completo

5,0/6,0 mm



**KM 092/01**

6,0/7,0 mm



**KM 092/02**

7,0/8,0 mm



**KM 092/03**

**KM 092/90**

Gebläse, allein  
 Rubbertube and bulb, only  
 Insuflador de goma, suelto  
 Soufflerie, seule  
 Soffiera, sola

Polypenschnürer  
 Polypus Snares  
 Polipótomos  
 Serre-nœuds  
 Serranodi

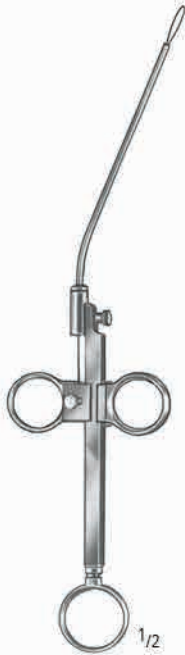

**KRAUSE**  
**KM 100/00**  
 16,0 cm/6 1/4"



**KRAUSE-VOSS**  
**KM 110/00**  
 16,0 cm/6 1/4"

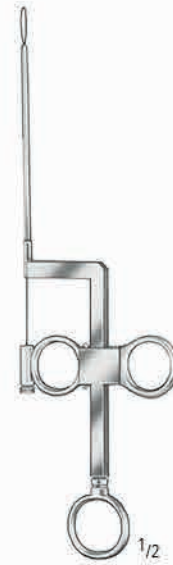

**LANGE-WILDE**  
**KM 115/00**  
 16,0 cm/6 1/4"



Packung 12 Stück  
 Pack. of 12 pcs.  
 Paquete de 12 unidades  
 en paquets de 12 pièces  
 pacco di 12 pezzi

**KM 130/02** = 0,2 mm  
**KM 130/03** = 0,3 mm

Packung 100 Stück  
 Pack. of 100 pcs.  
 Paquete de 100 unidades  
 en paquets de 100 pièces  
 pacco di 100 pezzi

**KM 132/02** = 0,2 mm  
**KM 132/03** = 0,3 mm

OHR OTOLGY OTOLOGIA OTOLOGIE OTOLOGIA

Ohrzängchen  
 Ear Forceps  
 Pinzas auriculares  
 Pincès auriculaires  
 Pinze auricolari

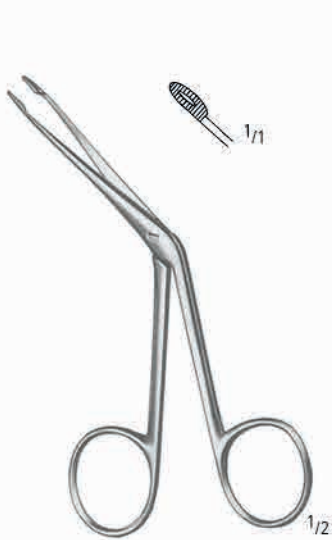

**HARTMANN**  
**KM 200/00**  
 12,0 cm/4<sup>3</sup>/<sub>4</sub>"



**HARTMANN**  
**KM 200/01**  
 14,0 cm/5<sup>1</sup>/<sub>2</sub>"



**TILLEY**  
**KM 201/00**  
 14,0 cm/5<sup>1</sup>/<sub>2</sub>"

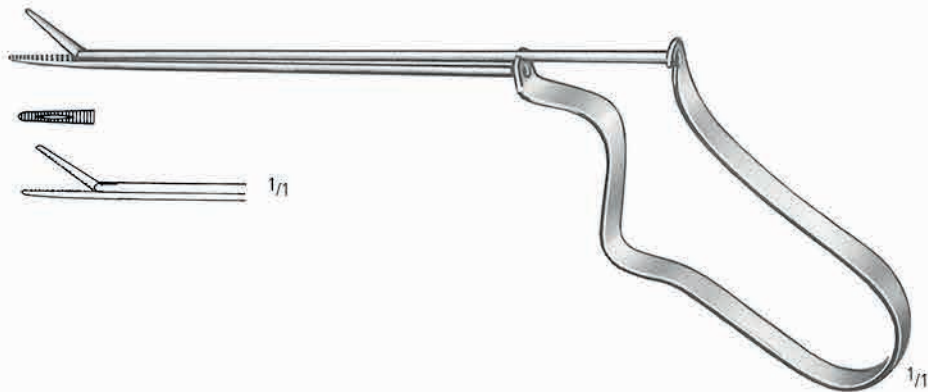

**BUCK**  
**KM 205/00**



**QUIRE**  
**KM 207/00**

AA  
 AB  
 AC  
 AD  
 AE  
 AF  
 AK  
 AL  
 AO  
 AP  
 AR  
 KA  
 KL  
 KM  
 KO  
 KU  
 KYE  
 X



Ohrzängchen  
 Ear Forceps  
 Pinzas auriculares  
 Pincès auriculaires  
 Pinze auricolari



**HARTMANN-WULLSTEIN**  
**KM 220/08**



**HARTMANN-WULLSTEIN**  
**KM 222/08**



**HARTMANN**  
**KM 226/08** 8,5 cm/3 1/3"  
**KM 226/14** 14,0 cm/5 1/2"



**HARTMANN**  
**KM 228/08**  
**KM 228/14**



**HARTMANN-NOYES**  
**KM 230/08**



**DUCKBILL**  
**KM 233/08**



**WEINGÄRTNER**  
**KM 234/08**



**HARTMANN**  
**KM 238/20** = 2,0 mm  
**KM 238/25** = 2,5 mm  
**KM 238/30** = 3,0 mm

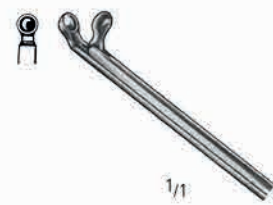

**HARTMANN**  
**KM 240/20** = 2,0 mm  
**KM 240/25** = 2,5 mm  
**KM 240/30** = 3,0 mm

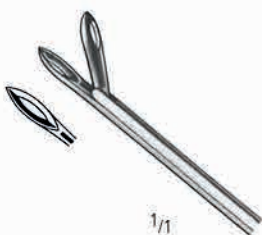

**STRÜMPEL**  
**KM 242/08**



**HARTMANN**  
**KM 244/08**

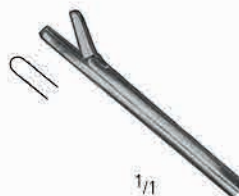

**HARTMANN**  
**KM 248/08**

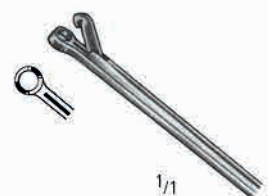

**HARTMANN-HOFFMANN**  
**KM 248/20**

OHR OTOLGY OTOLOGIA OTOLOGIE OTOLOGIA

Mikro Ohrzangchen  
 Micro Ear Forceps  
 Micro pinzas auriculares  
 Micro pinces auriculaires  
 Micro pinze auricolari

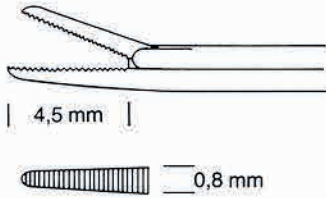

**KM 300/08**

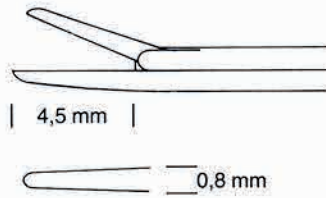

**KM 304/08**

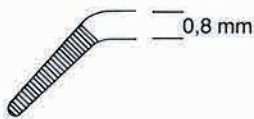

**KM 308/08**



**KM 312/08**

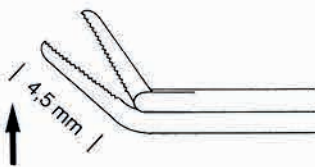

**KM 316/08**

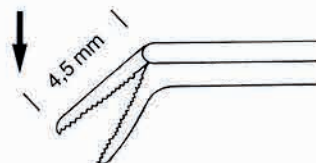

**KM 320/08**

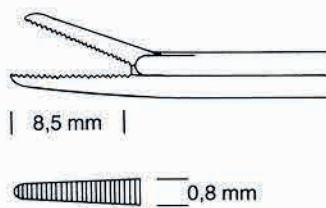

**KM 324/08**

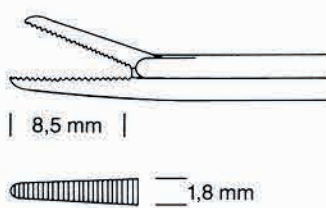

**KM 326/08**

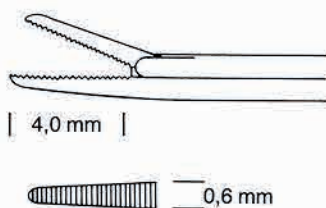

**KM 328/08**

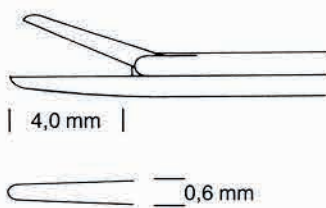

**KM 330/08**

AA  
AB  
AC  
AD  
AE  
AF  
AK  
AL  
AO  
AP  
AR  
KA  
KL  
KM  
KO  
KU  
KYE  
X

**KM** OHR OTOTOLOGY OTOLOGIA OTOLOGIE OTOLOGIA

Mikro Ohrzängchen  
 Micro Ear Forceps  
 Micro pinzas auriculares  
 Micro pinces auriculaires  
 Micro pinze auricolari

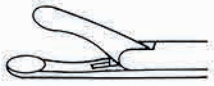

gerade  
 straight  
 rectas  
 droits  
 rette

**KM 334/08**

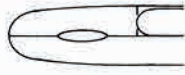

4,0 mm

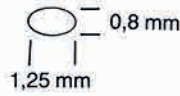

0,8 mm  
 1,25 mm



rechts gebogen  
 curved right  
 curvas derecha  
 courbes à droite  
 curva destra

**KM 338/08**

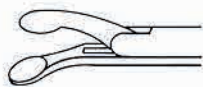

links gebogen  
 curved left  
 curvas izquierda  
 courbes à gauche  
 curva sinistra

**KM 342/08**

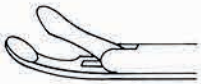

aufgebogen  
 curved up  
 curvas arriba  
 courbes en montant  
 curva in alto

**KM 346/08**



abgebogen  
 curved down  
 curvas abajo  
 courbes en bas  
 curva in basso

**KM 350/08**

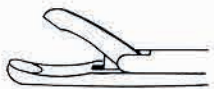

**CRURA-NIPPER**  
**KM 354/08**

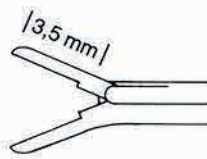

**McGEE**  
**KM 356/08**

OHR OTOLGY OTOLOGIA OTOLOGIE OTOLOGIA

Mikro Ohrzängchen  
 Micro Ear Forceps  
 Micro pinzas auriculares  
 Micro pinces auriculaires  
 Micro pinze auricolari

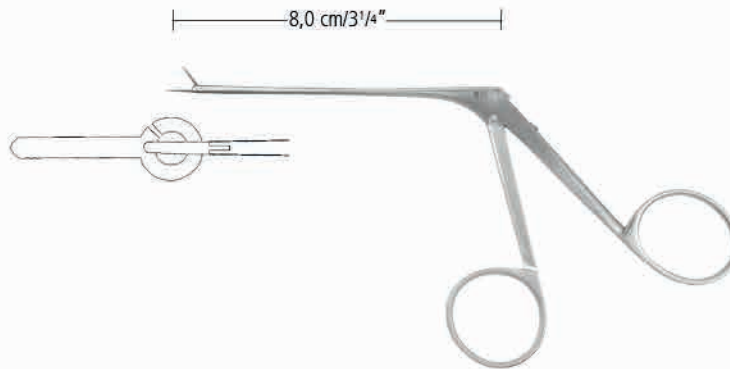

**FULLER**  
**KM 358/08**

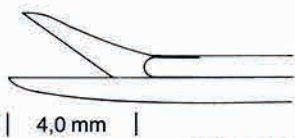

**KM 362/08**

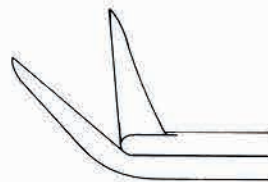

**KM 364/08**

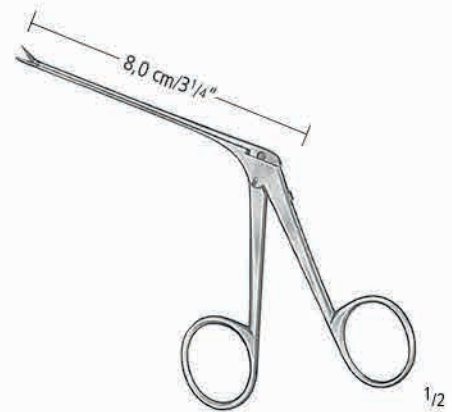

**BELLUCCI**

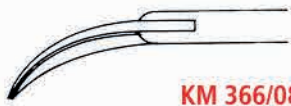

**KM 366/08**



**KM 370/08**

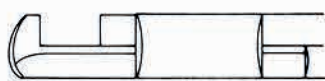

**KM 376/08**

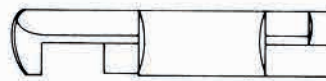

**KM 378/08**



**DIETER**

AA  
 AB  
 AC  
 AD  
 AE  
 AF  
 AK  
 AL  
 AO  
 AP  
 AR  
 KA  
 KL  
**KM**  
 KO  
 KU  
 KYE  
 X



**KM** OHR OTOTOLOGY OTOLOGIA OTOLOGIE OTOLOGIA

Mikro Ohrzängchen, Stanzen  
 Micro Ear Forceps, Punches  
 Micro pinzas auriculares, Pinzas osteótomos  
 Micro pinces auriculaires, Pincés ostéotomes  
 Micro pinze auricolari, Pinze osteotomi

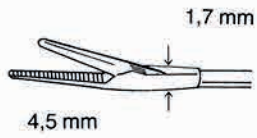

**KM 400/08**

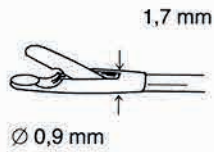

**KM 405/08**

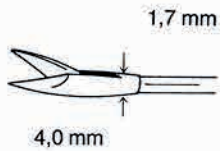

**KM 410/08**



**WULLSTEIN**



**CITELLI**  
**KM 490/01**  
**KM 490/02**  
**KM 490/03**



**BEYER**  
**KM 492/19**

Weitere Stanzen siehe Gruppen KO und KS.  
 For further Punches see sections KO and KS.  
 Para otras pinzas cortantes ver seccion KO y KS.  
 D'autres pincés coupantes voir groupe KO et KS.  
 Altre pinze taglienti vedi gruppo KO e KS.



OHR OTOLGY OTOLOGIA OTOLOGIE OTOLOGIA

Küretten, Löffel  
Curettes, Spoons  
Curetas, Cucharillas  
Curettes  
Curette, Cucchjai

stumpf - blunt - romas - mousses - smusse



KM 520/00 KM 521/00 KM 522/00 KM 522/01 KM 522/02 KM 522/03 KM 522/04 KM 522/05



Fig.000 00 0 1 2 3 4 5

KM 530/00 KM 531/00 KM 532/00 KM 532/01 KM 532/02 KM 532/03 KM 532/04 KM 532/05

scharf - sharp - cortantes - tranchantes - taglienti

**BUCK**  
16,5 cm/6 1/2"



KM 536/01 KM 536/02

**SHAPLEIGH**  
13,0 cm/5"



**LANGENBECK**  
KM 538/13  
13,0 cm/5"



**BARTH**  
KM 540/18  
18,0 cm/7"



**JANSEN**  
KM 542/15  
15,0 cm/6"

AA  
AB  
AC  
AD  
AE  
AF  
AK  
AL  
AO  
AP  
AR  
KA  
KL  
KM  
KO  
KU  
KYE  
X

Schlingen, Hackchen  
 Loops, Hooklets  
 Asas, Ganchitos  
 Anses, Crochets  
 Anse, Uncini



**KM 550/01**

**KM 550/02**

**KM 550/03**

**BILLEAU**  
 16,5 cm/6 1/2"



**KM 552/01**

**KM 552/02**

**SNELLEN**  
 16,5 cm/6 1/2"

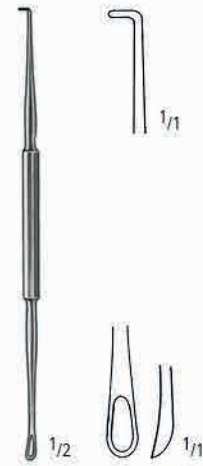

**GROSS**  
**KM 556/12**  
 12,0 cm/4 3/4"



**HARTMANN**  
**KM 560/16**  
 16,5 cm/6 1/2"

**ZAUFAL**  
**KM 566/16**  
 16,5 cm/6 1/2"



**WAGENER**  
 14,0 cm/5 1/2"

**LUCAE**  
 14,0 cm/5 1/2"

Parazentesenadeln, Messer  
 Paracentesis Needles, Knives  
 Aguja para paracentesis, Cuchillos  
 Aiguilles à paracentèse, Couteaux  
 Aghi per paracentesi, Coltelli



**POLITZER**  
**KM 610/16**  
 16,5 cm/6 1/2"



**LUCAE**  
**KM 612/18**  
 18,5 cm/7 1/8"



**POLITZER**  
**KM 614/17**  
 17,0 cm/6 3/4"



**POLITZER**  
**KM 616/16**  
 16,0 cm/6 1/4"

AA  
 AB  
 AC  
 AD  
 AE  
 AF  
 AK  
 AL  
 AO  
 AP  
 AR  
 KA  
 KL  
**KM**  
 KO  
 KU  
 KYE  
 X

Nadeln, Häkchen  
 Needles, Hooklets  
 Agujas, Ganchos  
 Aiguilles, Crochets  
 Aghi, Ganci



**BARBARA**  
 25°  
 KM 630/03  
 KM 630/06  
 KM 630/10

- 0,3 mm
- 0,6 mm
- 1,0 mm
- 1,2 mm
- 1,5 mm
- 2,0 mm
- 2,5 mm



**SHAMBAUGH**  
 45°  
 KM 631/03  
 KM 631/06  
 KM 631/10  
 KM 631/12  
 KM 631/15  
 KM 631/20  
 KM 631/25



**SHAMBAUGH**  
 90°  
 KM 632/03  
 KM 632/06  
 KM 632/10  
 KM 632/12  
 KM 632/15  
 KM 632/20  
 KM 632/25



**BARBARA**  
 KM 633/06  
 KM 633/10



16,0 cm/6 1/4"



**BARBARA**  
 KM 634/00



**BARBARA**  
 KM 634/01



**BARBARA**  
 KM 634/02



**ROSEN**  
 KM 634/03

OHR OTOLGY OTOLOGIA OTOLOGIE OTOLOGIA

Nadeln, Hakchen  
Needles, Hooklets  
Agujas, Ganchos  
Aiguilles, Crochets  
Aghi, Ganci



0,3 mm **KM 638/03**  
0,6 mm **KM 638/06**  
1,0 mm **KM 638/10**



**KM 640/03**  
**KM 640/06**  
**KM 640/10**



**KM 642/03**  
**KM 642/06**  
**KM 642/10**



0,3 mm **KM 639/03**  
0,6 mm **KM 639/06**  
1,0 mm **KM 639/10**



**KM 641/03**  
**KM 641/06**  
**KM 641/10**



**KM 643/03**  
**KM 643/06**  
**KM 643/10**



16,0 cm/6 1/4"



**McGEE**  
0,5 mm **KM 646/05**  
1,0 mm **KM 646/10**



**McGEE**  
**KM 647/05**  
**KM 647/10**



**BARBARA**  
**KM 648/00**



**ROSEN**  
**KM 648/01**

AA  
AB  
AC  
AD  
AE  
AF  
AK  
AL  
AO  
AP  
AR  
KA  
KL  
KM  
KO  
KU  
KYE  
X



**KM** OHR OTOTOLOGY OTOLOGIA OTOLOGIE OTOLOGIA

Messer  
Knives  
Cuchillos  
Couteaux  
Coltelli



1/2

**ROSEN**  
16,0 cm/6 1/4"



1/1

**KM 660/10**  
1,0 mm



1/1

**KM 660/14**  
1,4 mm



1/1

**KM 660/16**  
1,6 mm



1/1

**KM 660/20**  
2,0 mm



1/1

**KM 660/26**  
2,6 mm



1/1

**KM 660/28**  
2,8 mm



1/1

**KM 660/30**  
3,0 mm



1/2

16,0 cm/6 1/4"



1/1

**PLESTER**  
**KM 662/16**



1/1

**KM 663/16**



1/1

**PLESTER**  
**KM 665/16**



1/1

**TABB**  
**KM 666/16**



1/2

**SCHUKNECHT**  
16,0 cm/6 1/4"



1/1

**KM 667/16**



1/1

**KM 668/16**



1/2

**WULLSTEIN**  
**KM 669/16**  
16,0 cm/6 1/4"



1/1



1/2

**SCHUKNECHT**  
**KM 670/16**  
16,0 cm/6 1/4"



1/1



**FISCH**  
16,0 cm/6 1/4"



**KM 680/01**



**KM 680/02**



**KM 680/03**



**KM 680/04**



**HOUSE**  
16,0 cm/6 1/4"



**KM 682/35**  
3,5 mm



**KM 682/40**  
4,0 mm



**KM 682/45**  
4,5 mm



**KM 682/50**  
5,0 mm



**ROSEN**  
19,0 cm/7 1/2"



**KM 683/15**  
1,5 mm



**KM 683/25**  
2,5 mm



**ROSEN**  
16,0 cm/6 1/4"



**KM 684/01**



**KM 684/02**



**KM 684/03**

rund  
round  
redondo  
rond  
rotondo



**KM 684/04**



**KM 684/05**



**KM 684/06**



**PLESTER**  
**KM 685/16**  
16,0 cm/6 1/4"

**KM** OHR OTOTOLOGY OTOLOGIA OTOLOGIE OTOLOGIA

Instrumente für die Stapes-Fußplatte  
 Footplate Hand Instruments  
 Instrumentos para la platina estapediense  
 Instruments pour chirurgie de l'étrier  
 Strumenti per lo stapes



**HOUSE**  
 15,0 cm/6"  
**KM 703/01** 1,0 + 1,2 mm  
**KM 703/02** 1,5 + 1,8 mm



**HOUSE**  
 15,0 cm/6"  
**KM 705/01**  
**KM 705/02**

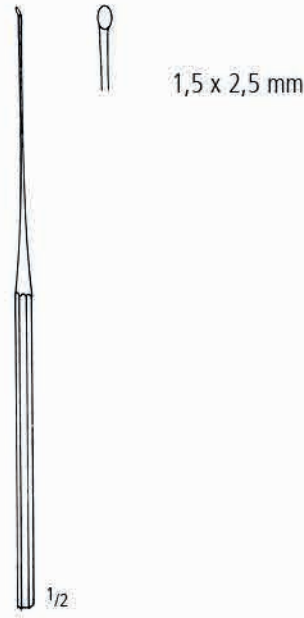

**SHEA**  
**KM 706/16**  
 16,0 cm/6 1/4"



**SHEA**  
**KM 707/16**  
 16,0 cm/6 1/4"



16,0 cm/6 1/4"



**BUCKINGHAM**  
**KM 710/01**



**BUCKINGHAM**  
**KM 710/02**



**BUCKINGHAM**  
**KM 710/03**



**LARKIN**  
**KM 711/01**



**LARKIN**  
**KM 711/02**



**LARKIN**  
**KM 711/03**

OHR OTOLGY OTOLOGIA OTOLOGIE OTOLOGIA

Instrumente für die Stapes-Fußplatte  
 Footplate Hand Instruments  
 Instrumentos para la platina estapediense  
 Instruments pour chirurgie de l'étrier  
 Strumenti per lo stapes



**HEERMANN**  
**KM 715/00**



0,7 mm  
**KM 715/01**



0,7 mm  
**KM 715/02**



1,0 mm  
**KM 715/03**



1,5 mm  
**KM 715/04**



3,0 mm  
**KM 715/05**



**KM 716/00**  
 19,5 cm/7<sup>3</sup>/<sub>4</sub>"



**SCHUKNECHT**  
**KM 717/00**



**FISCH**  
**KM 719/16**  
 16,0 cm/6<sup>1</sup>/<sub>4</sub>"

AA  
 AB  
 AC  
 AD  
 AE  
 AF  
 AK  
 AL  
 AO  
 AP  
 AR  
 KA  
 KL  
**KM**  
 KO  
 KU  
 KYE  
 X

Küretten, Elevatorien, Raspatorien  
 Curettes, Elevators, Raspatories  
 Curetas, Elevadores, Legras  
 Curettes, Elévateurs, Rugines  
 Curette, Elevatori, Periostotomi



- Fig. 0  
**KM 760/00**
- Fig. 00  
**KM 760/01**
- Fig. 000  
**KM 760/02**
- Fig. 0000  
**KM 760/03**
- Fig. 00000  
**KM 760/04**

**LEMPERT**  
21,0 cm/8<sup>1</sup>/<sub>4</sub>"



- 2,2 mm  
**KM 762/01**
- 3,2 mm  
**KM 762/02**

**WULLSTEIN**  
16,0 cm/6<sup>1</sup>/<sub>4</sub>"



3,0 mm

**LEMPERT**  
**KM 764/03**  
16,0 cm/6<sup>1</sup>/<sub>4</sub>"



**SHAMBAUGH-DERLACKI**  
**KM 765/16**  
16,5 cm/6<sup>1</sup>/<sub>2</sub>"



**LEMPERT**  
17,0 cm/6<sup>3</sup>/<sub>4</sub>"

- 2,0 mm  
**KM 766/02**
- 3,0 mm  
**KM 766/03**
- 4,0 mm  
**KM 766/04**
- 5,0 mm  
**KM 766/05**



Küretten, Elevatorien, Meißel, Messer  
 Curettes, Elevators, Chisel, Knives  
 Curetas, Elevadores, Cinceles, Cuchillos  
 Curettes, Elévateurs, Ciseaux, Coutreaux  
 Curette, Elevatori, Scalpelli, Coltelli



1/2

**JANSEN**

19,0 cm/7 1/2"

9,0 mm **KM 768/09**  
 14,0 mm **KM 768/14**



1/2

**PASSOW**

13,0 cm/5"

2,0 X 2,0 mm **KM 769/02**  
 3,0 X 3,0 mm **KM 769/03**



1/2

**BEALES**

16,0 cm/6 1/4"

Fig. 1

**KM 771/01**



Fig. 2

**KM 771/02**



1/2

**MUCK**

**KM 778/13**

13,0 cm/5"

AA  
AB  
AC  
AD  
AE  
AF  
AK  
AL  
AO  
AP  
AR  
KA  
KL  
KM  
KO  
KU  
KYE  
X

Saugrohre  
Suction Tubes  
Tubos de aspiración  
Canules d'aspiration  
Cannule per aspirazione



Weitere Sauginstrumente siehe Gruppe AO.  
More suction instruments in chapter AO.  
Para otras Tubos de aspiración ver seccion AO.  
D'autres canules d'aspiration groupe AO.  
Altre cannule per aspirazione vedi gruppo AO.



**HOUSE**

- 0,9 + 0,7 mm **KM 830/09**
- 1,2 + 0,9 mm **KM 830/12**
- 1,5 + 1,2 mm **KM 830/15**
- 1,8 + 1,8 mm **KM 830/18**
- 2,5 + 2,0 mm **KM 830/25**
- 3,0 + 2,0 mm **KM 830/30**
- 4,5 + 2,0 mm **KM 830/45**

**BARON (SCHUKNECHT)**

- 1,0 mm x 75 mm **KM 832/10**
- 1,5 mm x 75 mm **KM 832/15**
- 2,0 mm x 75 mm **KM 832/20**



**ZÖLLNER**  
**KM 835/00**



- Ø 0,5 mm **KM 835/05**
- Ø 0,7 mm **KM 835/07**



**WULLSTEIN**  
**KM 836/00**



**HOUSE**  
**KM 837/00**



**HOUSE**

- 0,6 mm **KM 838/06**
- 0,8 mm **KM 838/08**
- 1,0 mm **KM 838/10**
- 1,2 mm **KM 838/12**
- 1,5 mm **KM 838/15**
- 1,8 mm **KM 838/18**
- 2,0 mm **KM 838/20**
- 2,2 mm **KM 838/22**
- 2,5 mm **KM 838/25**
- 3,0 mm **KM 838/30**

Saugrohre  
Suction Tubes  
Tubos de aspiración  
Canules d'aspiration  
Cannule per aspirazione



**VERHOEVEN**

- 0,7 mm x 100 mm **KM 842/07**
- 0,9 mm x 100 mm **KM 842/09**
- 1,2 mm x 100 mm **KM 842/12**
- 1,6 mm x 100 mm **KM 842/16**



**VERHOEVEN**  
straight

- 1,2 mm x 90 mm **KM 843/12**
- 1,5 mm x 90 mm **KM 843/15**
- 2,0 mm x 90 mm **KM 843/20**
- 3,0 mm x 90 mm **KM 843/30**



**VERHOEVEN**  
down curved

- 1,2 mm x 90 mm **KM 844/12**
- 1,5 mm x 90 mm **KM 844/15**
- 2,0 mm x 90 mm **KM 844/20**



**VERHOEVEN**  
up curved

- 1,2 mm x 90 mm **KM 845/12**
- 1,5 mm x 90 mm **KM 845/15**
- 2,0 mm x 90 mm **KM 845/20**

AA  
AB  
AC  
AD  
AE  
AF  
AK  
AL  
AO  
AP  
AR  
KA  
KL  
KM  
KO  
KU  
KYE  
X



**COTTLE**  
**KM 850/24**  
 19,0 cm/7 1/2"  
 240 g



**HAJEK**  
**KM 851/14**  
 22,0 cm/8 3/4"  
 140 g



Ø 25,0 mm  
 320 g  
 mit auswechselbaren Backen  
 with interchangeable discs  
 con tapas intercambiables  
 avec plaques interchangeables  
 con placche intercambiabili.

**KA 556/32**  
 18,0 cm/7"

**KA 556/99**  
 Nylonbacken allein, paarweise  
 Nylon Faces only, pair  
 Tapas de Nylon sueltas, par  
 Plaques en Nylon seules, paire  
 Placche in Nylon sole, a paia



**HARTMANN**  
 14,0 cm/5 1/2"

- **KM 858/00**
- **KM 858/01**
- **KM 858/02**
- **KM 858/03**
- **KM 858/04**
- **KM 858/05**

Stimmgabeln  
Tuning Forks  
Diapasones  
Diapasons  
Diapason

**ALU**



**HARTMANN**



**HARTMANN  
ALU**



**LUCAE**



**HARTMANN-FRENCH**

- c<sup>2</sup> 16
- c<sup>2</sup> 32
- c 64
- c 128
- c<sup>1</sup> 256
- c<sup>2</sup> 512
- c<sup>3</sup> 1024
- c<sup>4</sup> 2048
- c<sup>5</sup> 4096

- KM 862/00
- KM 862/01
- KM 862/02
- KM 862/03
- KM 862/04
- KM 862/05

- KM 862/10
- KM 862/11
- KM 862/12
- KM 862/13
- KM 862/14
- KM 862/15

- KM 863/00
- KM 863/01
- KM 863/02
- KM 863/03
- KM 863/04
- KM 863/05

- KM 864/00
- KM 864/01
- KM 864/02
- KM 864/03
- KM 864/04



KM 865/05 = KM 862/02  
KM 862/03  
KM 862/04  
KM 864/03  
KM 864/04

KM 865/06 = KM 862/02  
KM 862/03  
KM 862/04  
KM 862/05  
KM 864/03  
KM 864/04

KM 865/08 = KM 862/02  
KM 862/03  
KM 862/04  
KM 862/05  
KM 864/01  
KM 864/02  
KM 864/03  
KM 864/04

AA  
AB  
AC  
AD  
AE  
AF  
AK  
AL  
AO  
AP  
AR  
KA  
KL  
KM  
KO  
KU  
KYE  
X



Stimmgabeln  
Tuning Forks  
Diapasones  
Diapasons  
Diapason

**ALU**



C 64

**KM 866/01**



C 128

**KM 866/02**



C 256

**KM 866/03**



C 512

**KM 866/04**



C 1024

**KM 866/05**



C 2048

**KM 866/06**



C 4096

**KM 866/07**



**KM 867/05 =** KM 866/02  
KM 866/03  
KM 866/04  
KM 866/05  
KM 866/06

OHR OTOLGY OTOLOGIA OTOLOGIE OTOLOGIA

Luftdusche, Pulverbläser  
Air Bag, Powder Blower  
Insufladores, Pulverizadores  
Insufflateurs  
Insuffiatori



KM 890/01



Ø 4 mm = KM 890/04



Ø 15 mm = KM 890/15  
Ø 17 mm = KM 890/17  
Ø 22 mm = KM 890/22



KM 890/30

**POLITZER**

- KM 890/00 = KM 890/00  
KM 890/04  
KM 890/15  
KM 890/17  
KM 890/22  
KM 890/30

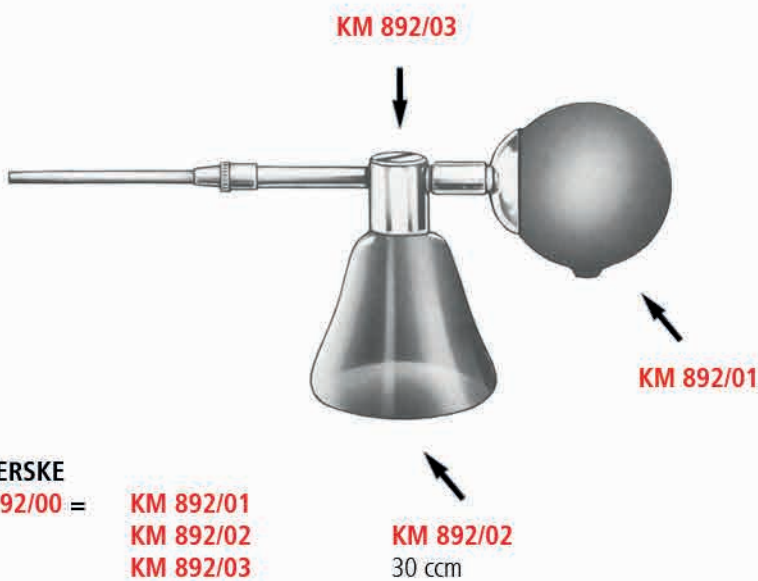

**KABIERSKE**

- KM 892/00 = KM 892/01  
KM 892/02  
KM 892/03  
KM 892/08  
KM 892/11  
KM 892/13

KM 892/02  
30 ccm



8,0 cm/3" KM 892/08



11,0 cm/4 1/3" KM 892/11



13,0 cm/5" KM 892/13

AA  
AB  
AC  
AD  
AE  
AF  
AK  
AL  
AO  
AP  
AR  
KA  
KL  
KM  
KO  
KU  
KYE  
X

Ohrspritzen  
 Ear Syringes  
 Jeringas auriculares  
 Seringues auriculaires  
 Siringhe per orecchio



**KM 898/01**



**KM 898/02**



**KM 898/03**



- 50 ml **KM 898/05**
- 75 ml **KM 898/08**
- 100 ml **KM 898/10**
- komplett
- complete
- completo
- complet
- completo

Paukenröhrchen  
 Ventilation Tubes  
 Tubes de ventilation  
 Tubos de ventilación  
 Tubi di ventilazione

**TITAN**



**TÜBINGER**

- Ø 1,00 mm = **KM 899/00**
- Ø 1,25 mm = **KM 899/01**
- Ø 1,50 mm = **KM 899/02**

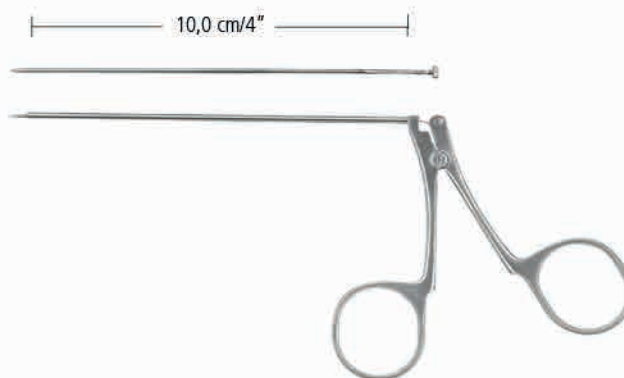

**KM 910/10**



**GELFOAM-HOUSE**

- 18,0 cm/7"
- 11 x 14 mm **KM 920/11**
- 22 x 30 mm **KM 920/22**
- 30 x 30 mm **KM 920/30**

AA  
 AB  
 AC  
 AD  
 AE  
 AF  
 AK  
 AL  
 AO  
 AP  
 AR  
 KA  
 KL  
**KM**  
 KO  
 KU  
 KYE  
 X





HNO  
ENT  
ORL

KO

nopa<sup>®</sup> instruments

Rhinologie  
Rhinology  
Rinología  
Rhinologie  
Rinología

Seite 309-358  
Page 309-358  
Página 309-358  
Page 309-358  
Pagina 309-358





NASE RHINOLOGY RINOLOGIA RHINOLOGIE RINOLOGIA

Nasenspekula  
Nasal Specula  
Especulos nasales  
Spéculums nasaux  
Specoli nasali



**HARTMANN-HALLE**  
15,0 cm/6"



**KO 050/01**



**KO 050/02**

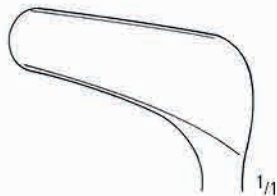

**KO 050/03**



**HARTMANN**  
15,0 cm/6"



**KO 052/01**

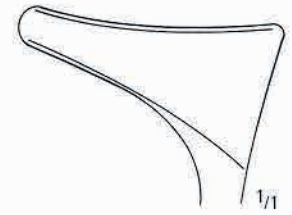

**KO 052/02**

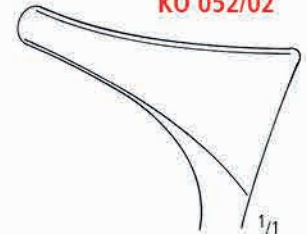

**KO 052/03**



**TIECK-HALLE**  
13,5 cm/5 1/4"



**KO 060/01**



**KO 060/02**



**BECKMANN**  
**KO 063/13**  
13,0 cm/5"



**BECKMANN**  
15,0 cm/6"



**KO 065/01**



**KO 065/02**



**KO 065/03**

AA  
AB  
AC  
AD  
AE  
AF  
AK  
AL  
AO  
AP  
AR  
KA  
KL  
KM  
KO  
KU  
KYE  
X

**KO** NASE RHINOLOGY RINOLOGIA RHINOLOGIE RINOLOGIA

Nasenspekula, Nasenrachen-Spekulum  
 Nasal Specula, Nasopharyngeal Speculum  
 Espécules nasales, Espéculo nasolaringeal  
 Spéculums nasaux, Spéculum nasopharyngien  
 Specoli nasali, Specolum nasolaringeale



**KILLIAN**  
13,0 cm/5"

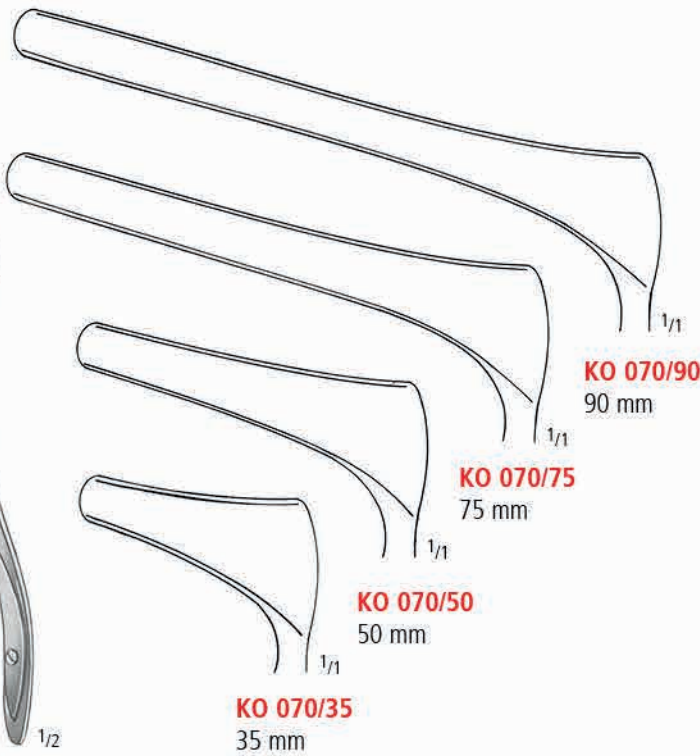

**KO 070/35**  
35 mm

**KO 070/50**  
50 mm

**KO 070/75**  
75 mm

**KO 070/90**  
90 mm

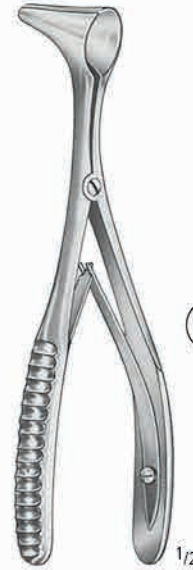

**MOD. WIEN**  
14,5 cm/5<sup>3</sup>/<sub>4</sub>"

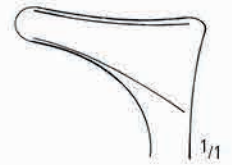

**KO 080/01**

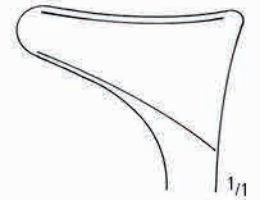

**KO 080/02**

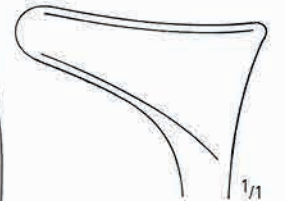

**KO 080/03**



**SONNENSCHN**  
**KO 081/15**  
15,0 cm/6"



**MARTIN**  
**KO 082/13**  
13,0 cm/5"



**CARDIFF**  
**KO 083/13**  
13,0 cm/5"



**PILCHER**  
**KO 084/15**  
15,0 cm/6"



**YANKAUER**  
**KO 087/19**  
19,0 cm/7<sup>1</sup>/<sub>2</sub>"

NASE RHINOLOGY RINOLOGIA RHINOLOGIE RINOLOGIA

Nasenspekula  
Nasal Specula  
Especúlos nasales  
Spéculums nasaux  
Specoli nasali



**COTTLE**  
**KO 090/01-04**  
15,0 cm/6"

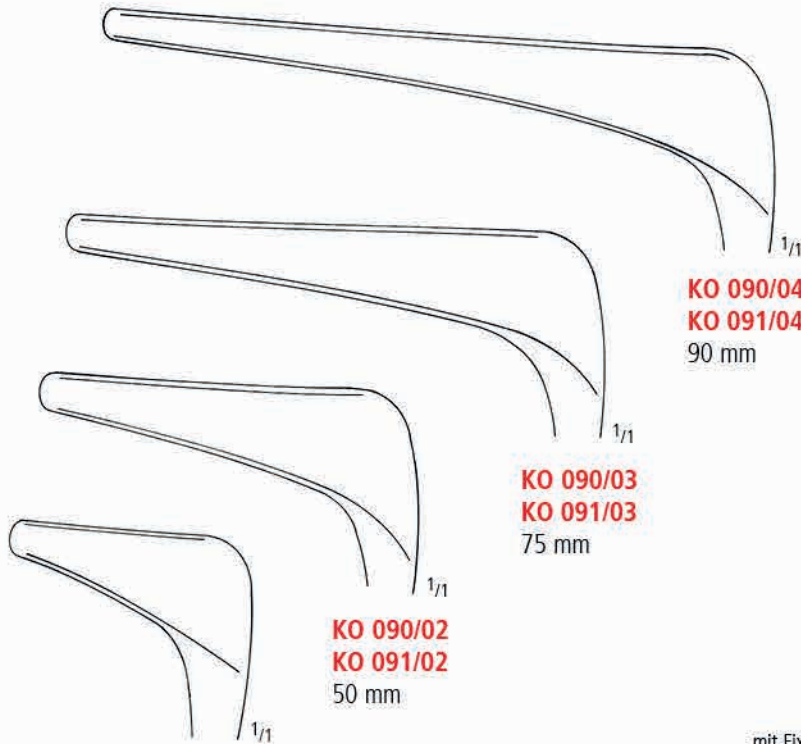

**KO 090/01**  
**KO 091/01**  
35 mm

**KO 090/03**  
**KO 091/03**  
75 mm

**KO 090/04**  
**KO 091/04**  
90 mm



mit Fixierschraube  
with fixing screw  
con tornillo de fijación  
avec vis de fixation  
con vite fissaggio

**COTTLE**  
**KO 091/01-04**  
15,0 cm/6"



**KO 094/01**



**KO 094/02**



**KO 094/03**

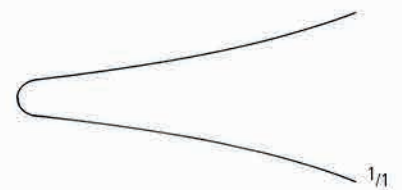

**KO 095/01**



**KO 095/02**

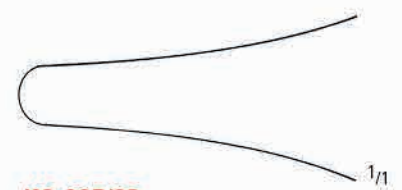

**KO 095/03**



**THUDICHUM**  
**(GOLDSMITH)**  
6,5 cm/2 1/2"



**VOLTOLINI**  
**(DUPLAY)**

AA  
AB  
AC  
AD  
AE  
AF  
AK  
AL  
AO  
AP  
AR  
KA  
KL  
KM  
KO  
KU  
KYE  
X



Polypenschnürer  
 Nasal Snares  
 Polipótomos  
 Serre-nœuds pour polypes  
 Serranodi per polipi



**KRAUSE**  
**KO 100/00**  
 26,0 cm/10<sup>1</sup>/<sub>2</sub>"



**KRAUSE-VOSS**  
**KO 102/00**  
 26,0 cm/10<sup>1</sup>/<sub>2</sub>"

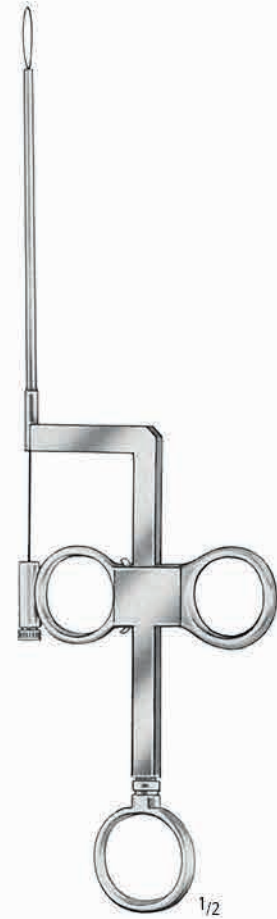

**LANGE-WILDE**  
**KO 104/00**  
 24,0 cm/9<sup>1</sup>/<sub>2</sub>"



**KO 120/12**

Bündel mit 12 Stück  
 bundles of 1 dozen each  
 en atados de 12 piezas  
 en paquets de 12 pièces  
 in fascetti di 12 pezzi



10,0 m/33 ft.

0,3 mm **KO 121/03**

NASE RHINOLOGY RINOLOGIA RHINOLOGIE RINOLOGIA

Polypenzangen  
 Nasal Polypus Forceps  
 Pinzas para pólipos  
 Pincès à polypes nasaux  
 Pinze per polipi nasali



**HARTMANN**  
 KO 150/16 16,0 cm/6<sup>1</sup>/<sub>4</sub>"  
 KO 150/20 20,0 cm/8"

**HEYMANN-KNIGHT**  
 KO 151/18 18,0 cm/7"

**LUBET-BARBON**  
 KO 152/20 20,0 cm/8"

**KILLIAN**  
 KO 153/17 17,0 cm/6<sup>3</sup>/<sub>4</sub>"

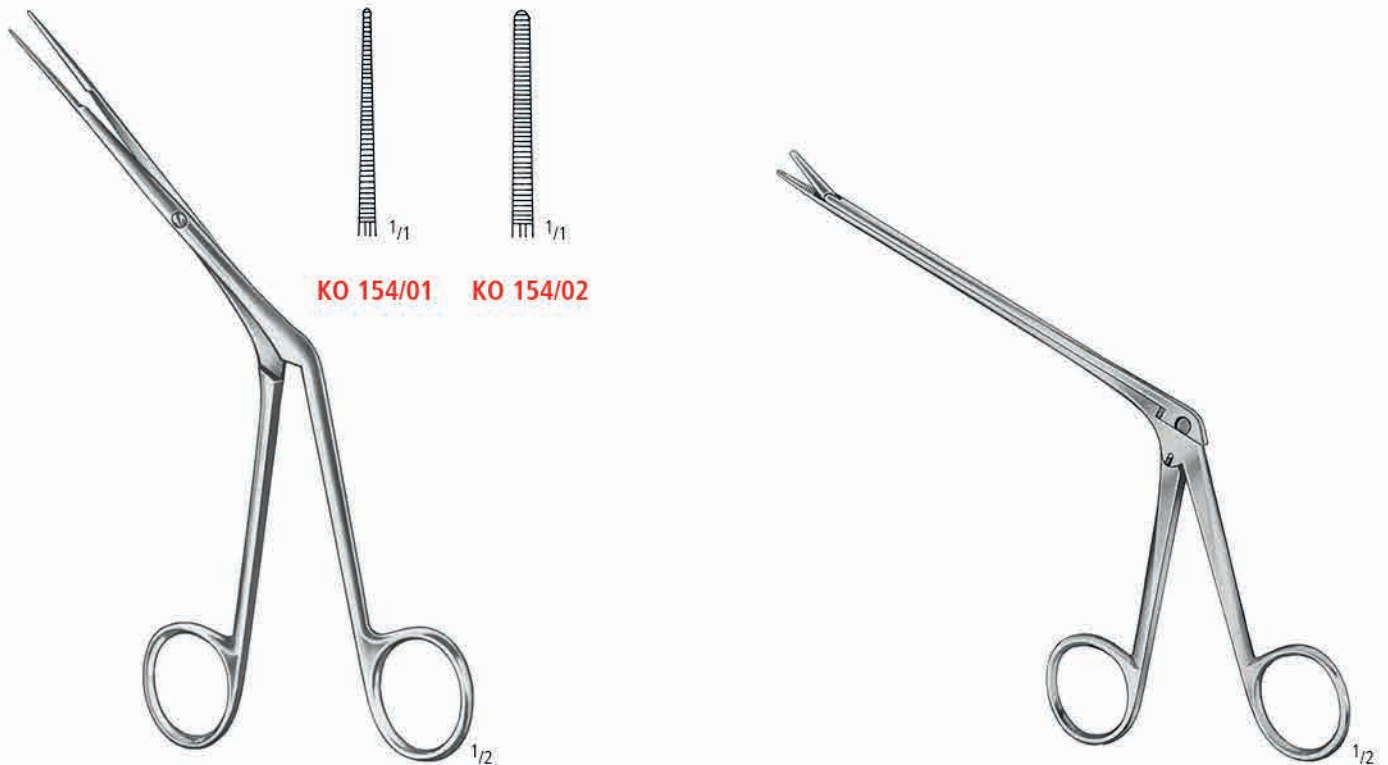

KO 154/01 KO 154/02

**WESTMACOTT**  
 20,0 cm/8"

**HARTMANN**  
 KO 155/19 19,0 cm/7<sup>1</sup>/<sub>2</sub>"

AA  
 AB  
 AC  
 AD  
 AE  
 AF  
 AK  
 AL  
 AO  
 AP  
 AR  
 KA  
 KL  
 KM  
 KO  
 KU  
 KYE  
 X



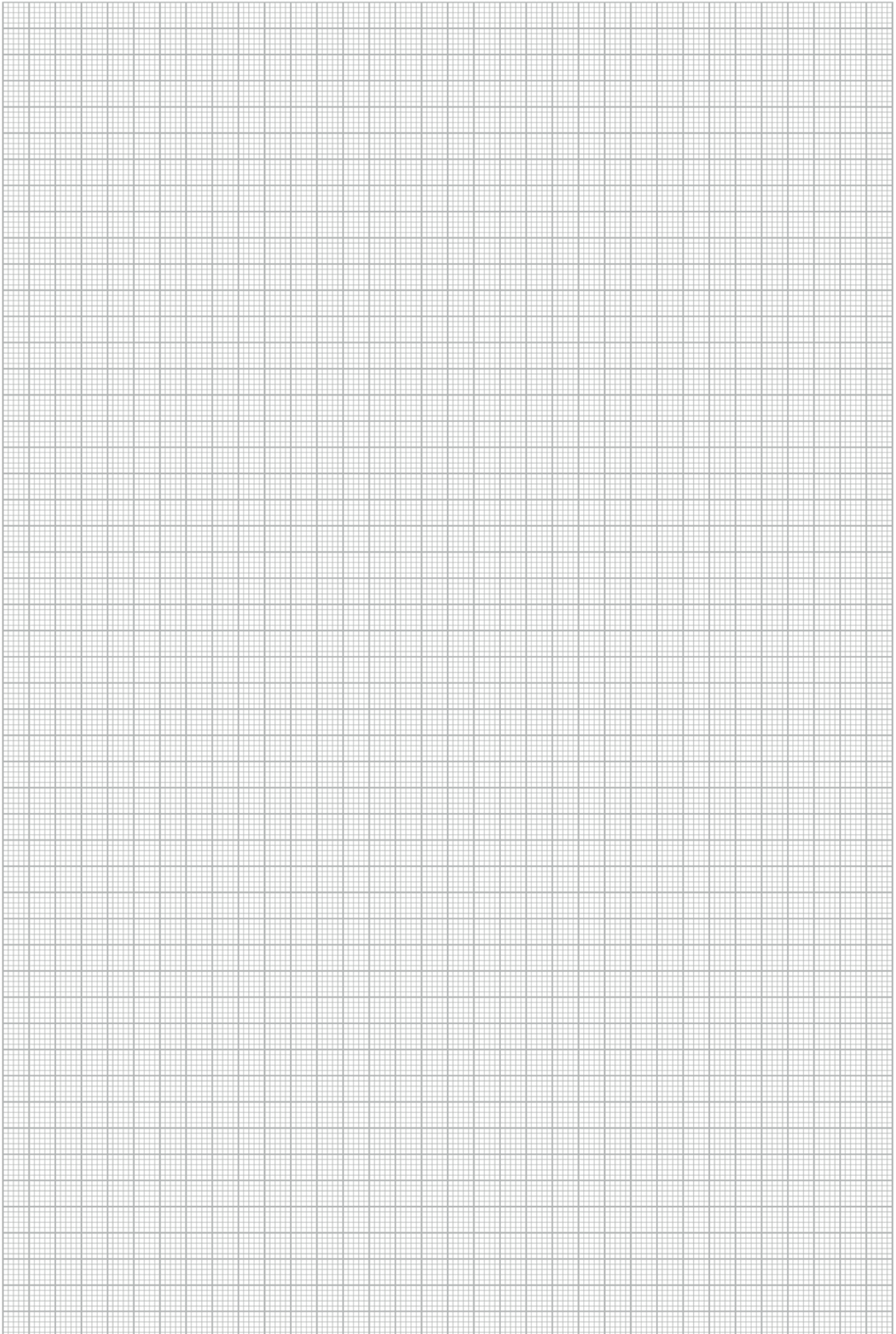

Stirnhöhlenstanze  
 Frontal sinus punch forceps  
 Pinzas para seno frontal  
 Pincès pour sinus frontal  
 Pinze per seno frontale

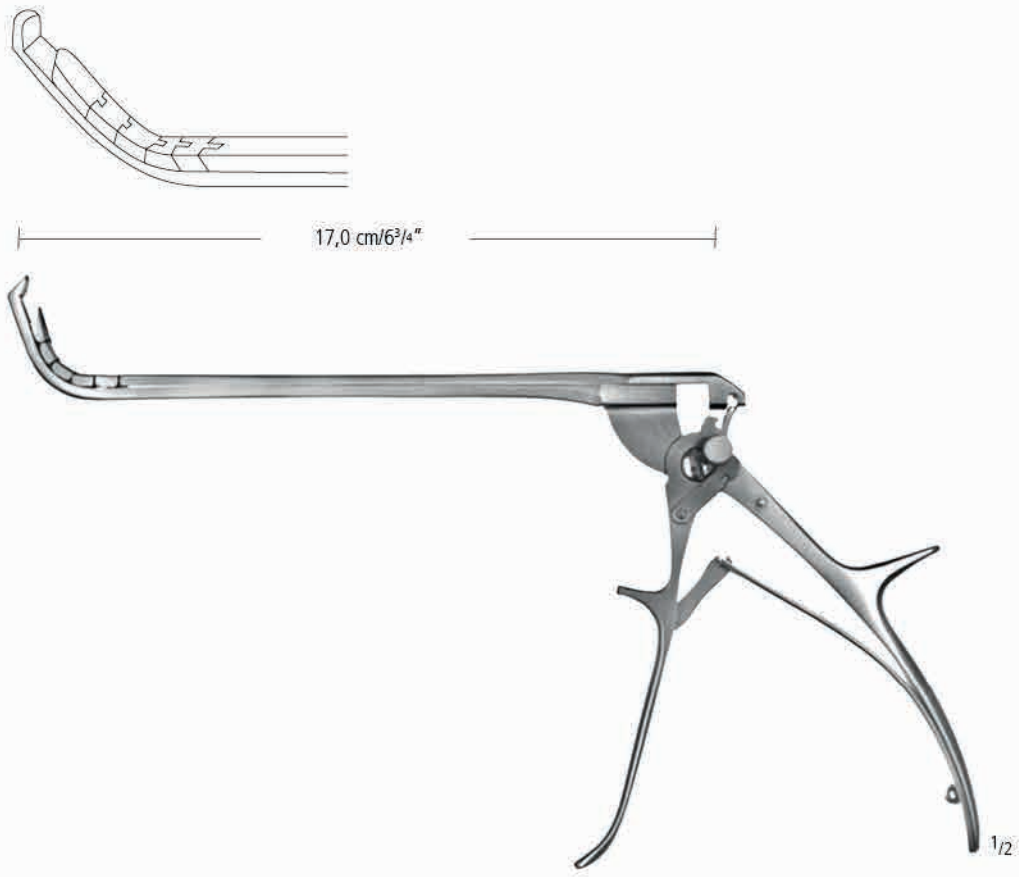





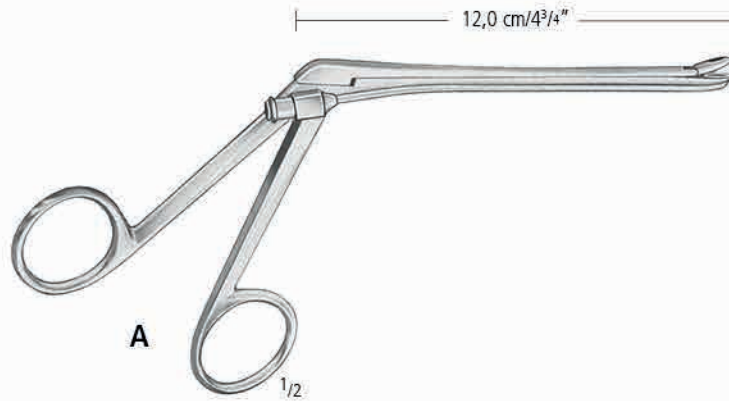

2,0 mm **KO 165/02**  
 3,0 mm **KO 165/03**

AA  
 AB  
 AC  
 AD  
 AE  
 AF  
 AK  
 AL  
 AO  
 AP  
 AR  
 KA  
 KL  
 KM  
**KO**  
 KU  
 KYE  
 X

Sinuskopie-Zängen  
 Sinuscopy Forceps  
 Pinzas para senoscopia  
 Pince à sinus  
 Pinze per sinuscopia



**WEIL-BLAKESLEY**

				
		2,5 mm	3,0 mm	3,5 mm
	0°	A <b>KO 170/01</b>	<b>KO 170/02</b>	<b>KO 170/03</b>
		B <b>KO 170/11</b>	<b>KO 170/12</b>	<b>KO 170/13</b>
	45°	A <b>KO 170/06</b>	<b>KO 170/07</b>	<b>KO 170/08</b>
		B <b>KO 170/16</b>	<b>KO 170/17</b>	<b>KO 170/18</b>
	90°	A <b>KO 170/21</b>	<b>KO 170/22</b>	<b>KO 170/23</b>
		B <b>KO 170/31</b>	<b>KO 170/32</b>	<b>KO 170/33</b>

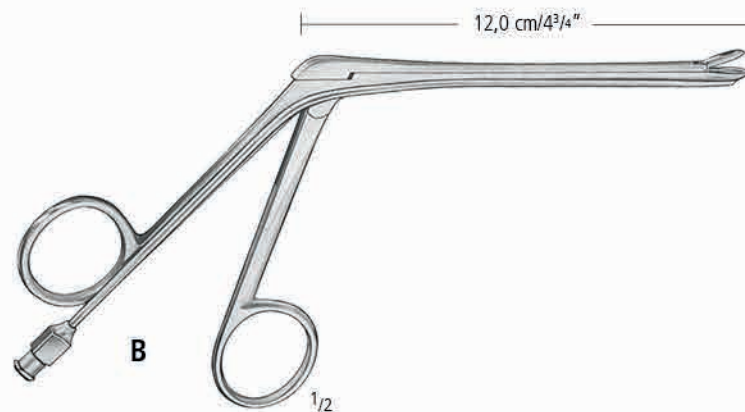









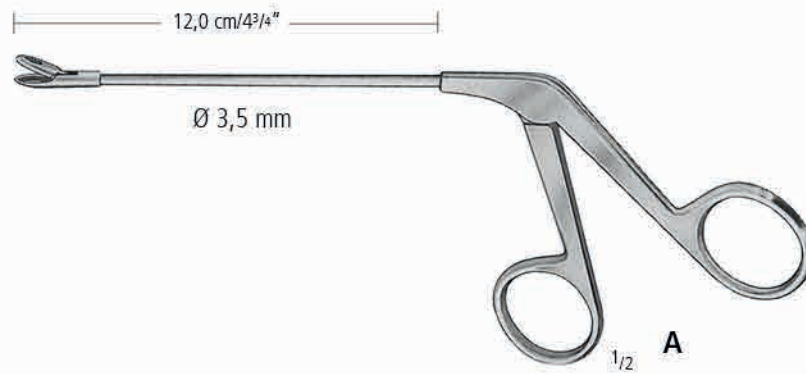

**WEIL-BLAKESLEY**



NASE RHINOLOGY RINOLOGIA RHINOLOGIE RINOLOGIA

Sinuskopie-Zangen  
 Sinuscopy Forceps  
 Pinzas para senoscopia  
 Pince à sinus  
 Pinze per sinuscopia



					
		2,5 mm	3,0 mm	3,5 mm	4,0 mm
WEIL-BLAKESLEY 0°	A	<b>KO 171/01</b>	<b>KO 171/02</b>	<b>KO 171/03</b>	<b>KO 171/04</b>
	B	<b>KO 171/11</b>	<b>KO 171/12</b>	<b>KO 171/13</b>	<b>KO 171/14</b>
					
		2,5 mm	3,0 mm	3,5 mm	4,0 mm
WEIL-BLAKESLEY 45°	A	<b>KO 171/06</b>	<b>KO 171/07</b>	<b>KO 171/08</b>	<b>KO 171/09</b>
	B	<b>KO 171/16</b>	<b>KO 171/17</b>	<b>KO 171/18</b>	<b>KO 171/19</b>
					
		4,0 x 10,0 mm			
TAKAHASHI	A	<b>KO 171/27</b>			
					
		1,0 x 10,0 mm			
STRUYCKEN	A	<b>KO 171/28</b>			

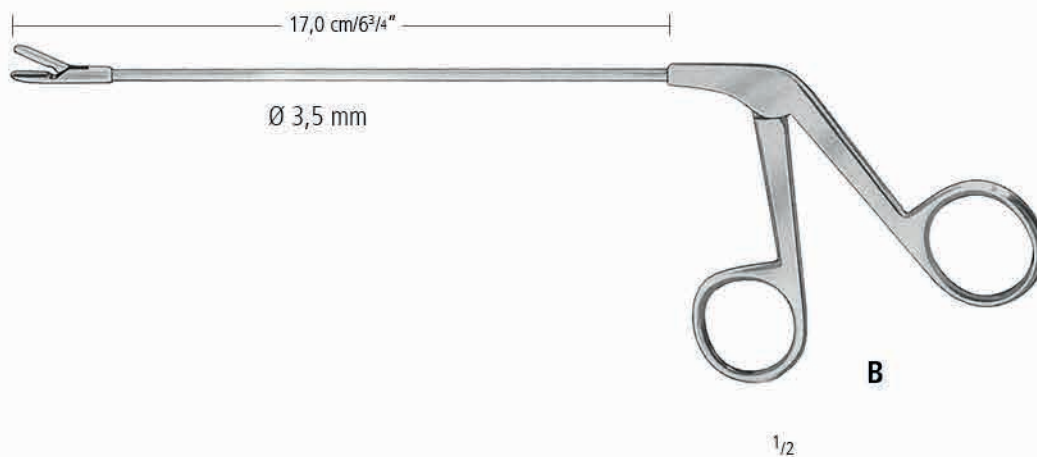

AA  
AB  
AC  
AD  
AE  
AF  
AK  
AL  
AO  
AP  
AR  
KA  
KL  
KM  
KO  
KU  
KYE  
X

Sinuskopie-Zangen  
 Sinuscopy Forceps  
 Pinzas para senoscopia  
 Pince à sinus  
 Pinze per sinuscopia

**STANZEN  
 RETRO-PUNCHES**

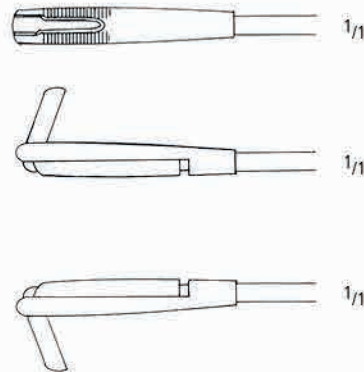

Ø 3,0 mm	Ø 4,5 mm
1,5 x 3,0 mm	2,5 x 6,5 mm

<b>KO 175/01</b>	<b>KO 175/03</b>
------------------	------------------

<b>KO 175/11</b>	<b>KO 175/13</b>
------------------	------------------

<b>KO 175/21</b>	<b>KO 175/23</b>
------------------	------------------

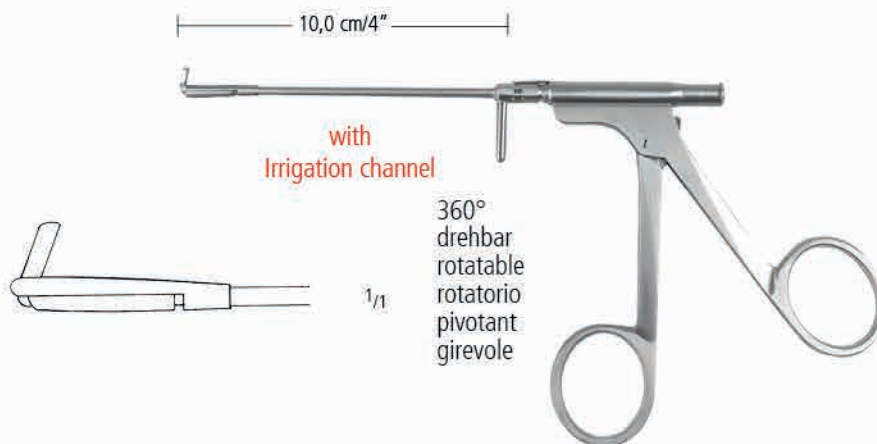

Ø 3,0 mm	Ø 3,0 mm
1,5 x 3,0 mm	2,0 x 5,0 mm

<b>KO 175/31</b>	<b>KO 175/32</b>
------------------	------------------

Sinuskopie-Zangen  
 Sinuscopy Forceps  
 Pinzas para senoscopia  
 Pince à sinus  
 Pinze per sinuscopia

**RUNDKOPF-STANZEN**  
**CIRCULAR-PUNCHES**

18,0 cm/7"

with  
Irrigation channel

$\alpha$	$\emptyset$	
0°	3,5 mm	<b>KO 177/01</b>
0°	4,5 mm	<b>KO 177/02</b>

17,0 cm/6¾"

with  
Irrigation channel

$\alpha$	$\emptyset$	
65°	3,5 mm	<b>KO 177/03</b>
65°	4,5 mm	<b>KO 177/04</b>

17,0 cm/ 6¾"

with  
Irrigation channel

$\alpha$	$\emptyset$	
45°	3,5 mm	<b>KO 177/05</b>
45°	4,5 mm	<b>KO 177/06</b>

AA  
AB  
AC  
AD  
AE  
AF  
AK  
AL  
AO  
AP  
AR  
KA  
KL  
KM  
KO  
KU  
KYE  
X

Sinuskopie-Zangen  
 Sinuscopy Forceps  
 Pinzas para senoscopia  
 Pince à sinus  
 Pinze per sinuscopia

**SCHEREN  
 SCISSORS**

glatt  
 smooth



**KO 180/01**



**KO 180/02**



**KO 180/03**

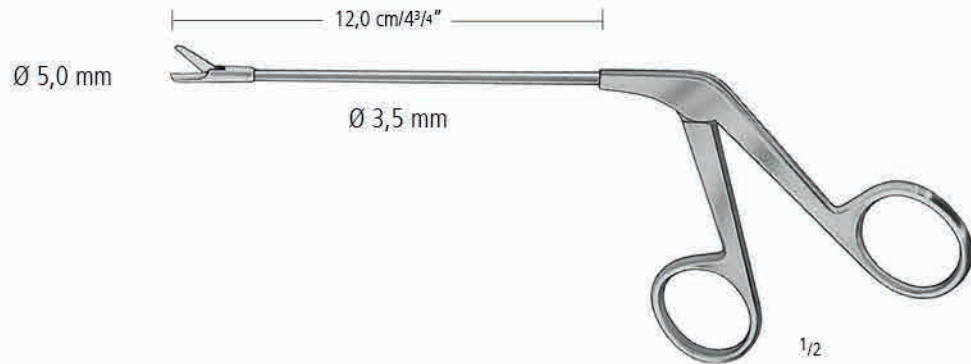

gezahnt  
 serrated



**KO 180/11**



**KO 180/12**



**KO 180/13**

Sinuskopie-Zangen  
 Sinuscopy Forceps  
 Pinzas para senoscopia  
 Pince à sinus  
 Pinze per sinuscopia

**SCHEREN  
 SCISSORS**

glatt  
 smooth

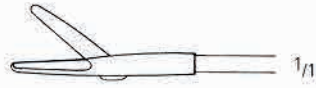

1/1

**KO 180/21**



1/1

**KO 180/22**



1/1

**KO 180/23**

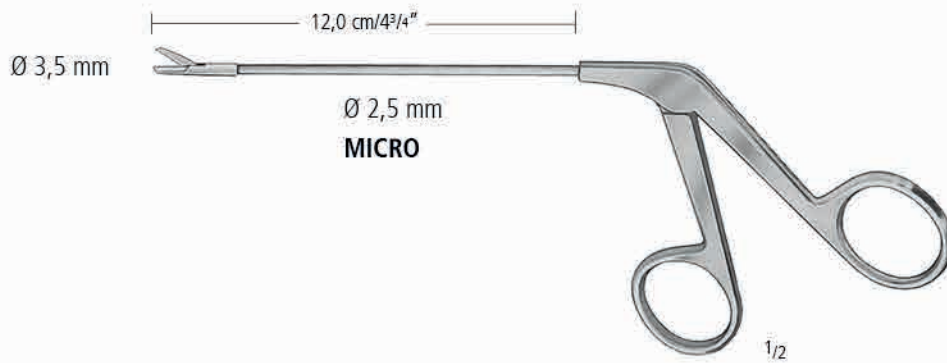

gezahnt  
 serrated



1/1

**KO 180/31**



1/1

**KO 180/32**



1/1

**KO 180/33**

AA  
 AB  
 AC  
 AD  
 AE  
 AF  
 AK  
 AL  
 AO  
 AP  
 AR  
 KA  
 KL  
 KM  
 KO  
 KU  
 KYE  
 X



Sinuskopie-Zangen  
 Sinuscopy Forceps  
 Pinzas para senoscopia  
 Pince à sinus  
 Pinze per sinuscopia

**STIRNHÖHLEN ZANGEN  
 FRONTAL SINUS FORCEPS**

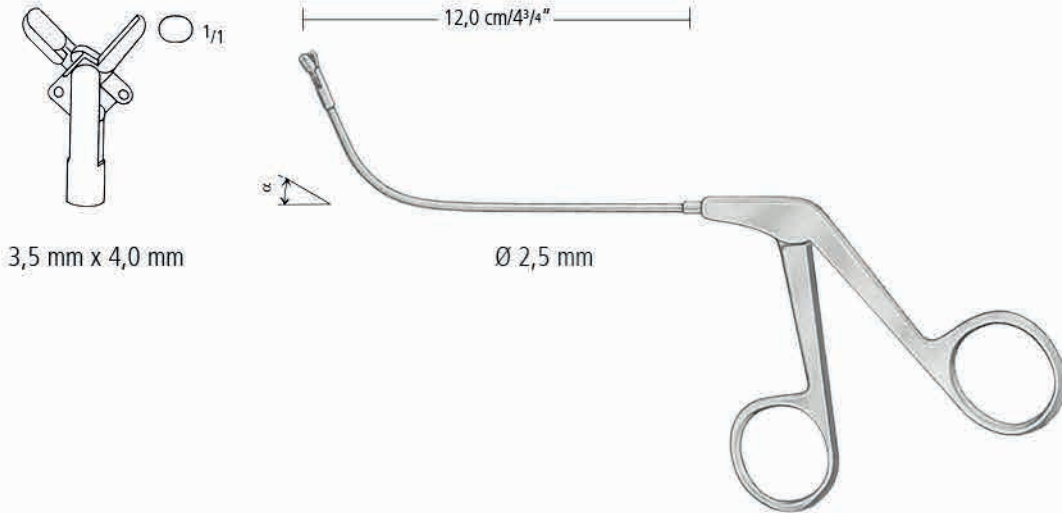

$\alpha$	horizontal öffnend horizontal cutting	vertikal öffnend vertical cutting
70°	<b>KO 185/01</b>	<b>KO 185/11</b>
90°	<b>KO 185/02</b>	<b>KO 185/12</b>
110°	<b>KO 185/03</b>	<b>KO 185/13</b>

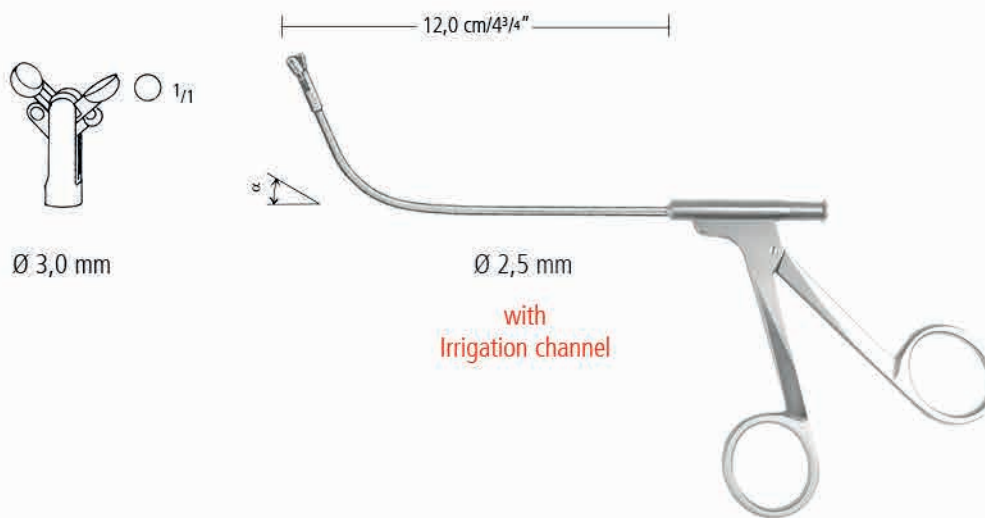

**STAMMBERGER**

$\alpha$	horizontal öffnend horizontal cutting	vertikal öffnend vertical cutting
65°	<b>KO 186/01</b>	<b>KO 186/02</b>

Sinuskopie-Zangen  
 Sinuscopy Forceps  
 Pinzas para senoscopia  
 Pince à sinus  
 Pinze per sinuscopia

**STIRNHÖHLEN ZANGEN  
 FRONTAL SINUS FORCEPS**

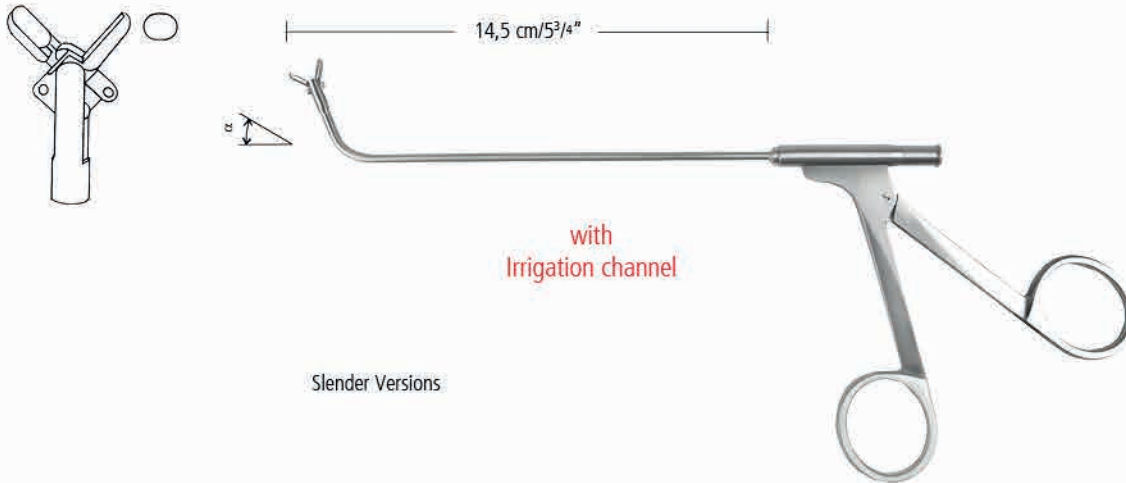

Slender Versions

	Ausstanzung Bite	horizontal öffnend horizontal cutting	vertikal öffnend vertical cutting
50°	2,0 mm	<b>KO 187/01</b>	<b>KO 187/02</b>
50°	3,0 mm	<b>KO 187/03</b>	<b>KO 187/04</b>
50°	4,0 mm	<b>KO 187/05</b>	<b>KO 187/06</b>
90°	2,0 mm	<b>KO 187/11</b>	<b>KO 187/12</b>
90°	3,0 mm	<b>KO 187/13</b>	<b>KO 187/14</b>
90°	4,0 mm	<b>KO 187/15</b>	<b>KO 187/16</b>

AA  
AB  
AC  
AD  
AE  
AF  
AK  
AL  
AO  
AP  
AR  
KA  
KL  
KM  
KO  
KU  
KYE  
X

Sinuskopie-Zangen  
 Sinuscopy Forceps  
 Pinzas para senoscopia  
 Pince à sinus  
 Pinze per sinuscopia

**KIEFERNHÖHLEN FASSZANGEN  
 ANTRUM GRASPING FORCEPS**

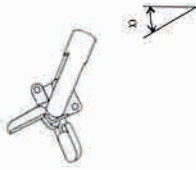

vertical jaw opening

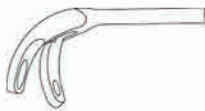
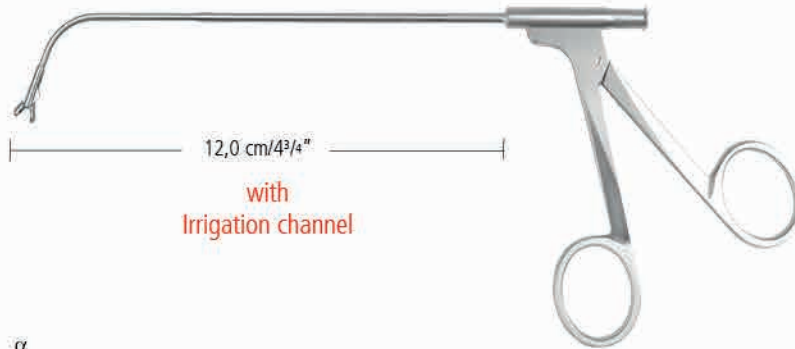

90° bis 120° rückwärts  
 90° to 120° backbiter

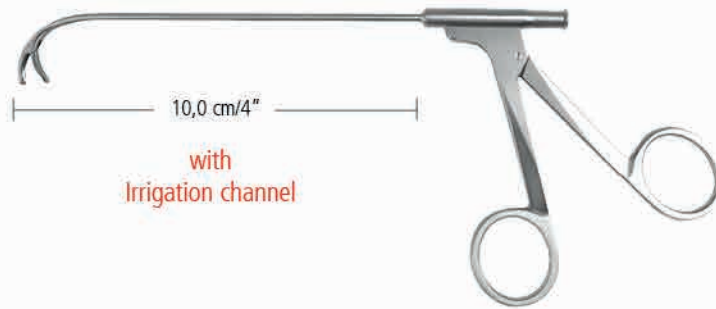

**KO 190/02**



90° bis 120° rückwärts  
 90° to 120° backbiter

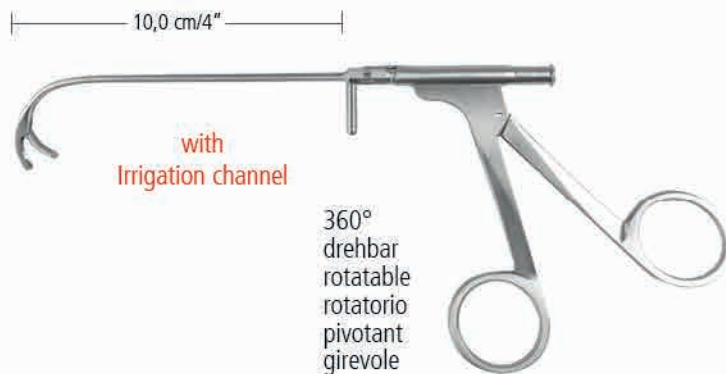

**KO 190/03**

NASE RHINOLOGY RINOLOGIA RHINOLOGIE RINOLOGIA

Sinuskopie-Zangen  
 Sinuscopy Forceps  
 Pinzas para senoscopia  
 Pince à sinus  
 Pinze per sinuscopia



KO 200/01



KO 200/02



KO 200/03



KO 200/04



KO 200/05

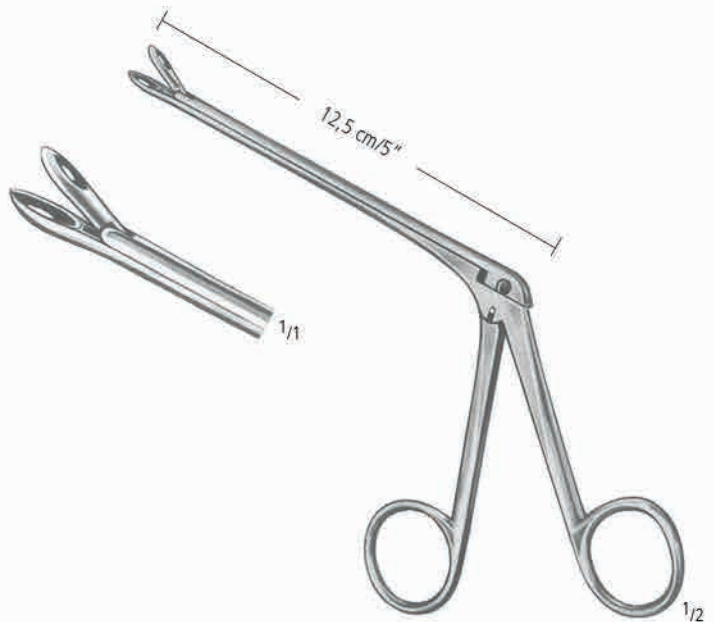

WEIL-BLAKESLEY



KO 201/01



KO 201/02



KO 201/03

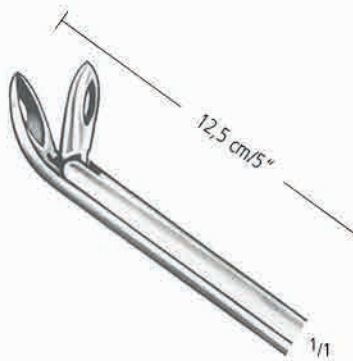

WEIL-BLAKESLEY

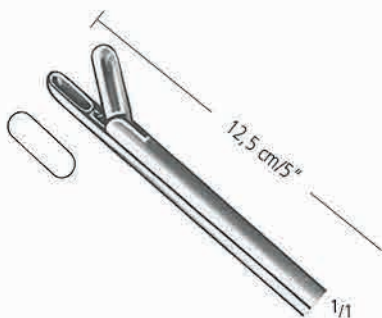

WATSON-WILLIAMS  
 KO 203/12

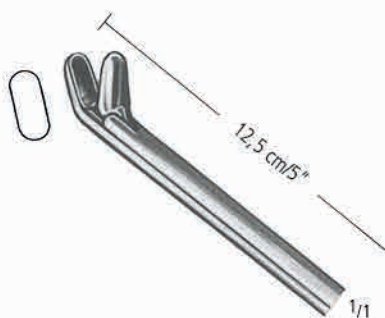

WATSON-WILLIAMS  
 KO 204/12

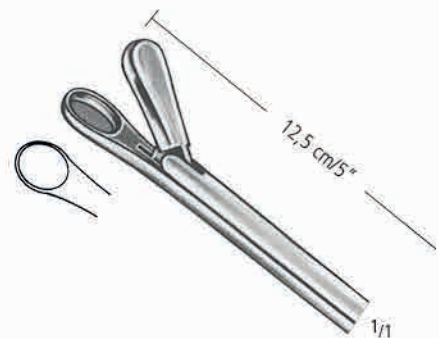





WATSON-WILLIAMS  
 KO 205/12

AA  
 AB  
 AC  
 AD  
 AE  
 AF  
 AK  
 AL  
 AO  
 AP  
 AR  
 KA  
 KL  
 KM  
 KO  
 KU  
 KYE  
 X

**KO** NASE RHINOLOGY RINOLOGIA RHINOLOGIE RINOLOGIA

Scharfe Nasenzangen  
 Nasal Cutting Forceps  
 Pinzas cortantes para nariz  
 Pincès coupantes pour le nez  
 Pinze taglienti per il naso

-   $\frac{1}{1}$  5 mm  
**KO 210/05**
-   $\frac{1}{1}$  7 mm  
**KO 210/07**
-   $\frac{1}{1}$  9 mm  
**KO 210/09**
-   $\frac{1}{1}$  11 mm  
**KO 210/11**



**HARTMANN**



**KO 214/01**



**KO 214/02**



**KO 214/03**

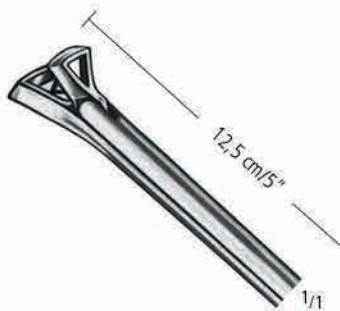

**SCHMEDEN**



**KO 215/01**



**KO 215/02**



**STRUYCKEN**



NASE RHINOLOGY RINOLOGIA RHINOLOGIE RINOLOGIA

Scharfe Nasenzangen  
 Nasal Cutting Forceps  
 Pinzas cortantes para nariz  
 Pincès coupantes pour le nez  
 Pinze taglienti per il naso



TAKAHASHI

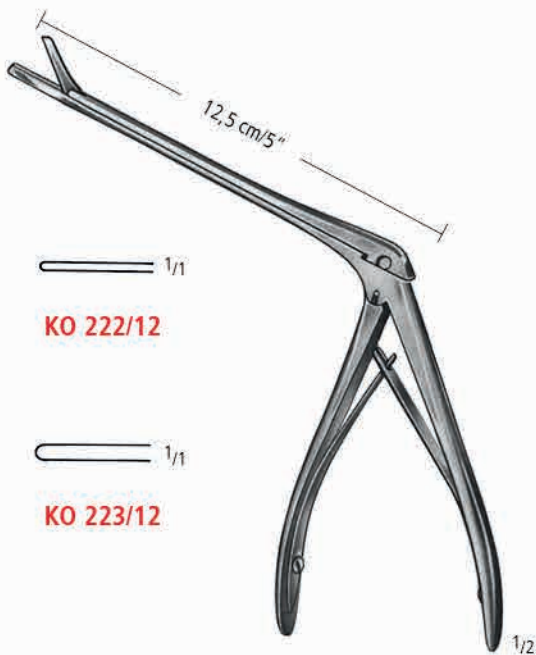

STRUYCKEN



JANSEN-MIDDLETON

KO 225/19  
 19,0 cm/7 1/2"



JANSEN-MIDDLETON

KO 226/19  
 19,0 cm/7 1/2"

AA  
 AB  
 AC  
 AD  
 AE  
 AF  
 AK  
 AL  
 AO  
 AP  
 AR  
 KA  
 KL  
 KM  
 KO  
 KU  
 KYE  
 X

Siebbein- und Septumzangen  
 Ethmoid and Septum Forceps  
 Pinzas para etmoides y para el tabique nasal  
 Pince ethmoidales et pour la cloison nasale  
 Pinze etmoidali e per il setto nasale



**CRAIG**  
**KO 230/17**  
 17,0 cm/6<sup>3</sup>/<sub>4</sub>"



**BRUENINGS**  
 19,0 cm/7<sup>1</sup>/<sub>2</sub>"

**KO 235/01**

**KO 235/02**

**KO 235/03**

**KO 235/04**



**LUC**  
 20,0 cm/8"

**KO 236/01**

**KO 236/02**

**KO 237/01**

**KO 237/02**

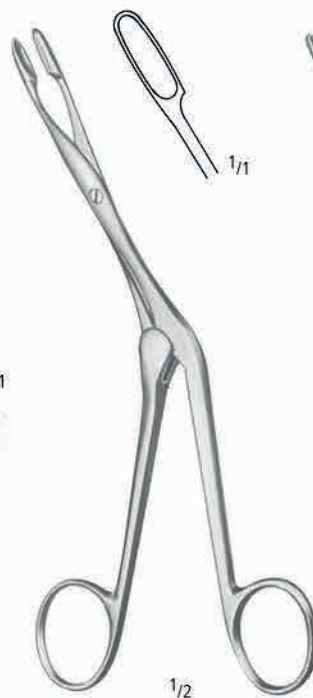

**KNIGHT**  
**KO 238/18**  
 18,0 cm/7"



**HEYMANN**  
 18,0 cm/7"

**KO 240/01**

**KO 240/02**

**KO 240/03**

NASE RHINOLOGY RINOLOGIA RHINOLOGIE RINOLOGIA

Nasenzangen  
Nasal Forceps  
Pinzas para nariz  
Pincas pour le nez  
Pinze per il naso

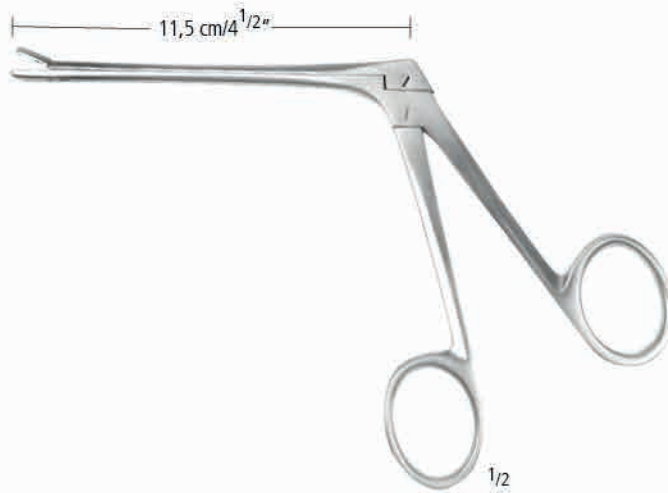

**ST. BARTHOLOMEW**  
3,0 mm  
19,0 cm / 7 1/2"

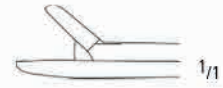

**KO 245/00**  
straight

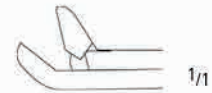

**KO 245/01**  
140° up

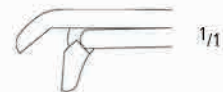

**KO 245/02**  
140° down



**KAZANJIAN**  
**KO 247/19**  
19,0 cm / 7 1/2"



**JATHO**  
**KO 248/15**  
15,0 cm / 6"

AA  
AB  
AC  
AD  
AE  
AF  
AK  
AL  
AO  
AP  
AR  
KA  
KL  
KM  
KO  
KU  
KYE  
X

**KO** NASE RHINOLOGY RINOLOGIA RHINOLOGIE RINOLOGIA

Keilbeinstanzen  
 Sphenoid Punches  
 Pinzas para seno esfenoidal  
 Pincès pour sinus sphénoïdal  
 Pinze per seno sfenoidale

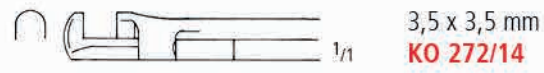
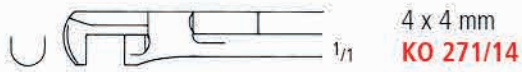

**HAJEK-KOFFLER**



**HAJEK-KOFFLER**  
**KO 274/16**



**KERRISON**



Keilbeinstanzen  
Sphenoid Punches  
Pinzas para seno esfenoidal  
Pinces pour sinus sphénoïdal  
Pinze per seno sfenoidale

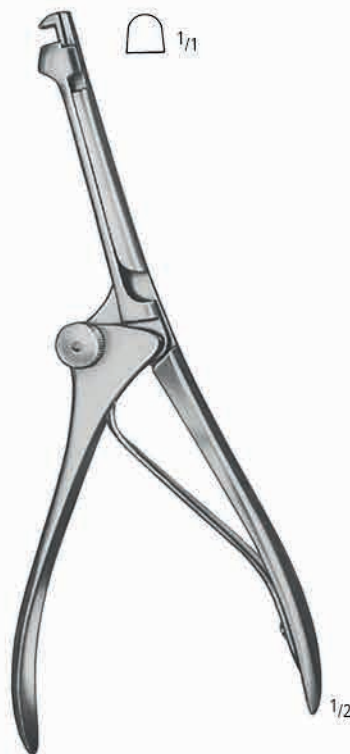
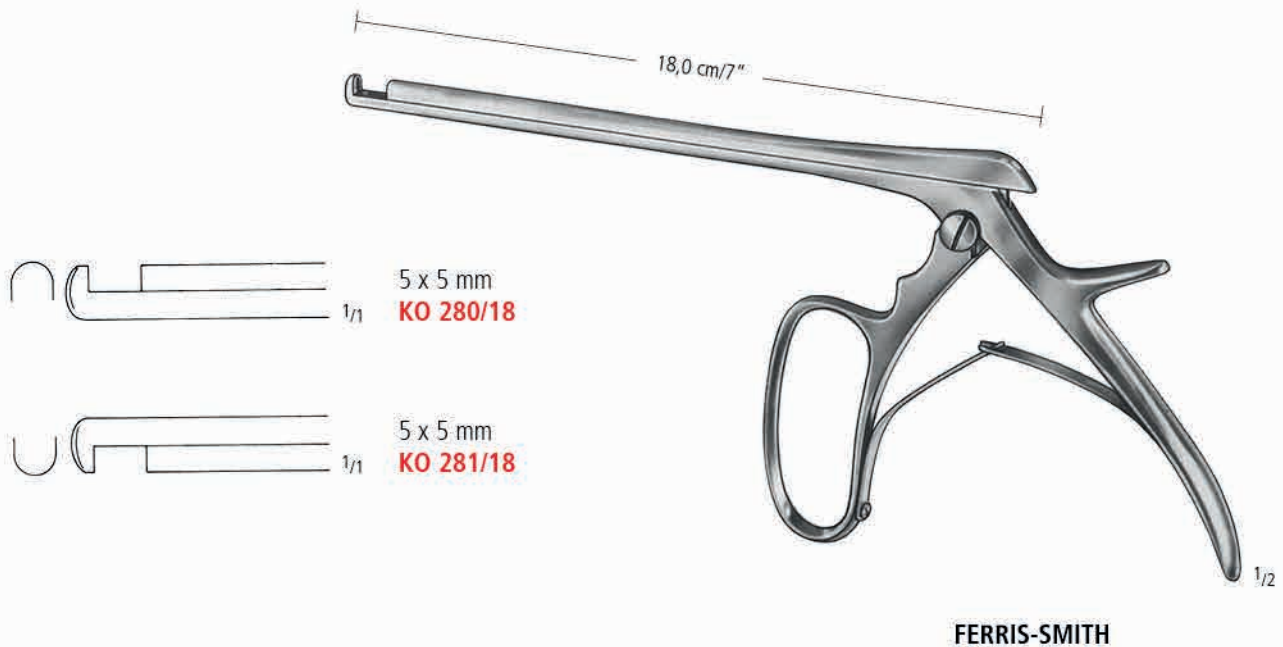

**HAJEK-CLAUS**  
**KO 285/20**  
20,0 cm/8"

Weitere Stanzen in Gruppe KS.  
For further punches see section KS.  
Para otras pinzas cortantes ver seccion KS.  
D'autres pinces coupantes voir groupe KS.  
Altre pinze taglienti vedi gruppo KS.

AA  
AB  
AC  
AD  
AE  
AF  
AK  
AL  
AO  
AP  
AR  
KA  
KL  
KM  
KO  
KU  
KYE  
X



**KO** NASE RHINOLOGY RINOLOGIA RHINOLOGIE RINOLOGIA

Nasenplastik- und Operationsmesser  
 Rhinoplastic and Nasal Knives  
 Bisturías para operaciones de la nariz  
 Bistouris pour opérations du nez  
 Bisturi per operazioni nasali

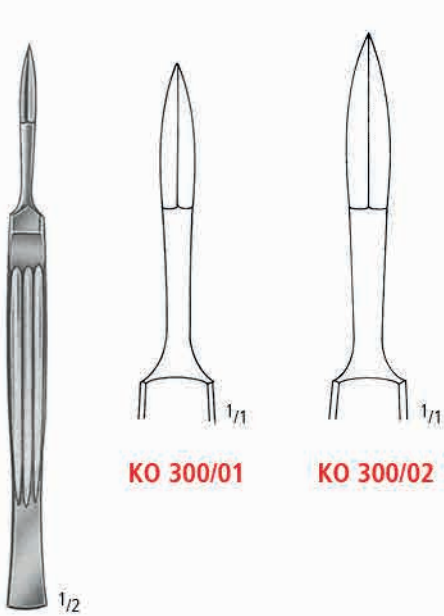

**KO 300/01**

**KO 300/02**

**JOSEPH**  
**KO 300/01-KO 301/02**  
 14,5 cm/5<sup>3</sup>/<sub>4</sub>"



**FOMON**  
**KO 304/16**  
 16,0 cm/6<sup>1</sup>/<sub>4</sub>"



**MASING**  
**KO 305/13**  
 13,0 cm/5"



**COTTLE**  
**KO 306/15**  
 15,0 cm/6"



**COTTLE**  
**KO 307/15**  
 15,0 cm/6"



**CONVERSE**  
**KO 308/16**  
 16,0 cm/6<sup>1</sup>/<sub>4</sub>"



**JOSEPH**  
**KO 309/15**  
 15,0 cm/6"



**FREER "D"**  
**KO 310/01**  
 15,0 cm/6"



**FREER**  
**KO 310/03**  
 15,0 cm/6"



**JOSEPH**  
**KO 316/16**  
 16,5 cm/6<sup>1</sup>/<sub>2</sub>"

NASE RHINOLOGY RINOLOGIA RHINOLOGIE RINOLOGIA

Saug-Elevatoren, Spülkanülen, Septumnadel, Stirnhöhlen-Dilatator  
 Aspirating Elevator, Irrigating Cannulas, Septum needle, Frontal Sinus Dilators  
 Elevador aspirador, Cánulas irrigación, Agujas para Septum, Dilatadores para el seno frontal  
 Élévateur aspirant, Canules à irrigation, Aiguilles pour Septum, Dilatateurs pour le sinus frontal  
 Elevatore con aspirazione, Cannule per irrigazione, Aghi per Septum, Dilatatori per il seno frontale



**FREER**  
**KO 320/21**  
 21,0 cm/8<sup>1</sup>/<sub>4</sub>"



**GORNEY**  
**KO 321/18**  
 18,0 cm/7"



**NEGUS**  
**KO 322/21**  
 21,0 cm/8<sup>1</sup>/<sub>4</sub>"



**PAULSEN**  
 18,0 cm/7<sup>3</sup>/<sub>4</sub>"  
 Ø 1,5 mm **KO 323/15**  
 Ø 2,5 mm **KO 323/25**



**GUILLEN**  
**KO 324/20**  
 20,0 cm/8"



20,0 cm/8"  
 Ø 4,0 mm **KO 325/40**  
 Ø 5,0 mm **KO 325/50**



**MYLES**  
 9,0 cm/3<sup>1</sup>/<sub>2</sub>" **KO 326/09**  
 11,5 cm/4<sup>1</sup>/<sub>2</sub>" **KO 326/11**  
 Silver



**SEPTUM**  
**KO 327/08**  
 Ø 0,8mm  
 Luer



**RITTER-HALLE**  
 2,5 mm **KO 328/25**  
 3,0 mm **KO 328/30**  
 4,0 mm **KO 328/40**  
 5,0 mm **KO 328/50**

Sauginstrumente siehe Gruppe AO  
 More suction instruments in chapter AO  
 Para otras Tubos de aspiración ver sección AO  
 D'autres canules d'aspiration groupe AO  
 Altre cannule per aspirazione vedi gruppo AO

AA  
 AB  
 AC  
 AD  
 AE  
 AF  
 AK  
 AL  
 AO  
 AP  
 AR  
 KA  
 KL  
 KM  
 KO  
 KU  
 KYE  
 X

**KO** NASE RHINOLOGY RINOLOGIA RHINOLOGIE RINOLOGIA

Septummesser, Septum- und Periost-Elevatoren  
 Septum Knives, Septum and Periosteal Elevators  
 Bisturios para el tabique nasal y para el periostio, elevadores  
 Bistouris pour la cloison et le périoste, élévateurs  
 Bisturi per il setto ed il periostio, elevatori



**BALLENGER**  
**KO 330/03-05**  
 20,0 cm/8"



3,0 mm  
**KO 330/03**  
**KO 331/03**



4,0 mm  
**KO 330/04**  
**KO 331/04**



5,0 mm  
**KO 330/05**  
**KO 331/05**



**BALLENGER**  
**KO 331/03-05**  
 20,0 cm/8"



**TRELAT**  
**KO 333/14**  
 14,5 cm/ 5<sup>3</sup>/<sub>4</sub>"



**BALLENGER**  
 5,0 x 4,0 mm  
**KO 334/22**  
 22,0 cm/8<sup>3</sup>/<sub>4</sub>"



**ROGER**  
 4,5 x 4,5 mm  
**KO 335/19**  
 19,0 cm/7<sup>1</sup>/<sub>2</sub>"



**CARTER**  
**KO 336/21**  
 21,0 cm/8<sup>1</sup>/<sub>4</sub>"



**AUFRICHT**  
**KO 338/17**  
 17,0 cm/6<sup>3</sup>/<sub>4</sub>"

NASE RHINOLOGY RINOLOGIA RHINOLOGIE RINOLOGIA

Septum- und Periost-Elevatoren  
 Septum and Periosteal Elevators  
 Elevadores para el tabique nasal y para el periostio  
 Élévateurs pour la cloison et le périoste  
 Elevatori per il setto ed il periostio

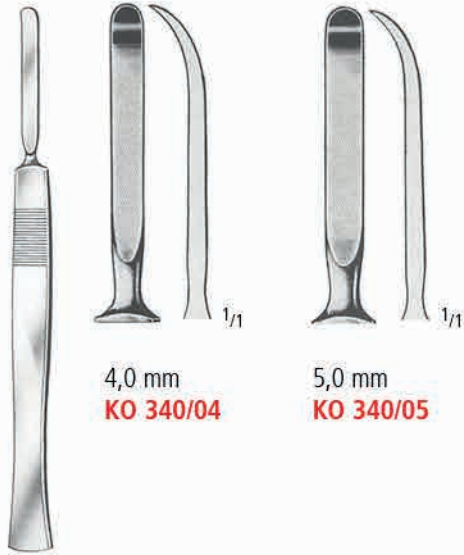

4,0 mm  
**KO 340/04**

5,0 mm  
**KO 340/05**



**HALLE**  
**KO 342/16**  
 16,5 cm/6 1/2"



**JOSEPH**  
**KO 343/16**  
 16,0 cm/6 1/4"

**McKENTY**  
 15,0 cm/6"



**KO 344/19**

scharf  
 sharp  
 cortante  
 tranchant  
 tagliente

**KO 345/19**

stumpf  
 blunt  
 romo  
 mousse  
 smusso

**JOSEPH-MASING**  
**KO 341/22**  
 21,0 cm/8 1/4"



**COTTLE**  
**KO 349/23**  
 23,0 cm/9"



**McKENTY**  
**KO 350/22**  
 22,0 cm/8 3/4"

**FREER**  
 19,0 cm/7 1/2"

**FREER**  
**KO 348/18**  
 18,0 cm/7"

AA  
 AB  
 AC  
 AD  
 AE  
 AF  
 AK  
 AL  
 AO  
 AP  
 AR  
 KA  
 KL  
 KM  
 KO  
 KU  
 KYE  
 X



Septum- und Periost-Elevatorien  
 Septum and Periosteal Elevators  
 Elevadores para el tabique nasal y para el periostio  
 Élévateurs pour la cloison et le périoste  
 Elevatori per il setto ed il periostio



**COTTLE**  
**KO 352/21**  
 21,0 cm/8<sup>1</sup>/<sub>4</sub>"



**MASING**  
**KO 353/21**  
 21,0 cm/8<sup>1</sup>/<sub>4</sub>"



**HOWARTH**  
**KO 354/21**  
 21,5 cm/8<sup>1</sup>/<sub>2</sub>"



**KILLIAN**  
**KO 355/18**  
 18,0 cm/7"



**KILLIAN**  
**KO 356/22**  
 22,0 cm/8<sup>3</sup>/<sub>4</sub>"



NASE RHINOLOGY RINOLOGIA RHINOLOGIE RINOLOGIA

Instrumente zur Nasenplastik  
 Rhinoplastic Instruments  
 Instrumentos para la plástica nasal  
 Instruments pour la plastique nasale  
 Strumenti per la plastica nasale



**NOLST-TRENITÉ  
 JOSEPH**  
**KO 357/20**  
 20,0 cm/8"



**PIERCE**  
**KO 358/21**  
 21,0 cm/8 1/4"



**PENNINGTON**  
**KO 359/21**  
 21,0 cm/8 1/4"



**JOSEPH**  
 19,0 cm/7 1/2"



**KO 362/00**



**KO 362/01**



**KO 362/02**

AA  
 AB  
 AC  
 AD  
 AE  
 AF  
 AK  
 AL  
 AO  
 AP  
 AR  
 KA  
 KL  
 KM  
 KO  
 KU  
 KYE  
 X

**KO** NASE RHINOLOGY RINOLOGIA RHINOLOGIE RINOLOGIA

Nasenraspeln  
Nasal Rasps  
Escofinas nasal  
Râpes nasale  
Raspe nasali

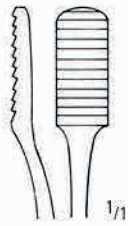

**KO 365/01**

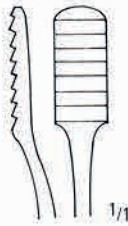

**KO 365/02**

**LEWIS**  
18,0 cm/7"

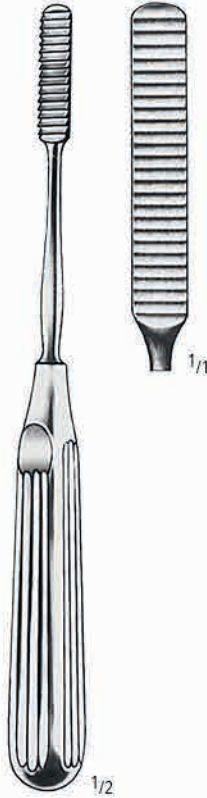

**COTTLE**  
**KO 366/21**  
21,0 cm/8 1/4"

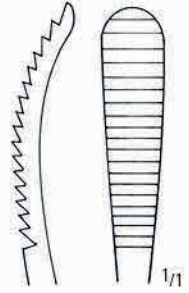

**KO 367/01**

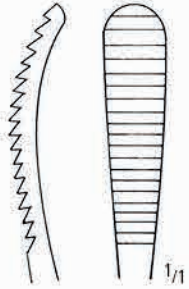

**KO 367/02**

**AUFRICHT**  
21,0 cm/8 1/4"

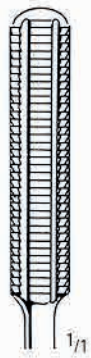

**MALTZ**  
**KO 368/18**  
18,0 cm/7"



nopa®  
**TUE**

**AUFRICHT GLABELLA**  
**KO 368/20**  
20,0 cm/8"



**KO 369/01**



**KO 369/02**

**JOSEPH**  
16,0 cm/6 1/4"



**GALLAGHER**  
**KO 370/00**  
16,0 cm/6 1/4"

NASE RHINOLOGY RINOLOGIA RHINOLOGIE RINOLOGIA

Nasenraspeln  
Nasal Rasps  
Escofinas nasal  
Râpes nasale  
Raspe nasali



**WIENER**  
18,0 cm/7"



**KO 375/01**



**KO 375/02**

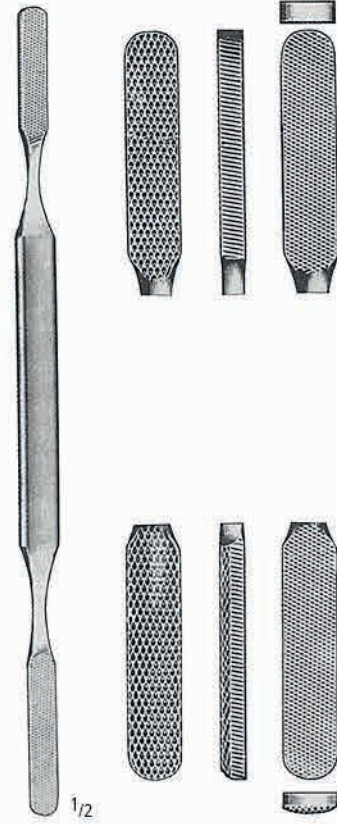

**FOMON**  
**KO 377/21**  
21,0 cm/8 1/4"

nopa® DIAMOND



**FOMON**  
**KO 377/31**  
21,0 cm/8 1/4"



**MASING**  
**KO 378/21**  
21,0 cm/8 1/4"



**MASING**  
**KO 379/21**  
21,0 cm/8 1/4"

AA  
AB  
AC  
AD  
AE  
AF  
AK  
AL  
AO  
AP  
AR  
KA  
KL  
KM  
KO  
KU  
KYE  
X

Nasenraspel  
Nasal Rasps  
Escofinas nasal  
Râpes nasale  
Raspe nasali



Fig. 1  
**KO 380/01**



Fig. 2  
**KO 380/02**



Fig. 3  
**KO 380/03**



Fig. 4  
**KO 380/04**



Fig. 5  
**KO 380/05**



**MILLER-COLBURN**  
**KO 380/01-05**  
19,0 cm/7 1/2"



Fig. 1  
**KO 381/01**



Fig. 2  
**KO 381/02**



Fig. 3  
**KO 381/03**



Fig. 4  
**KO 381/04**



Fig. 5  
**KO 381/05**



**MILLER-COLBURN**  
**KO 381/01-05**  
19,0 cm/7 1/2"



NASE RHINOLOGY RINOLOGIA RHINOLOGIE RINOLOGIA

Nasenraspeln  
Nasal Rasps  
Escofinas nasal  
Râpes nasale  
Raspe nasali



**LEWIS**  
KO 390/01-02  
18,0 cm/7"



nopa®  
**TUC**

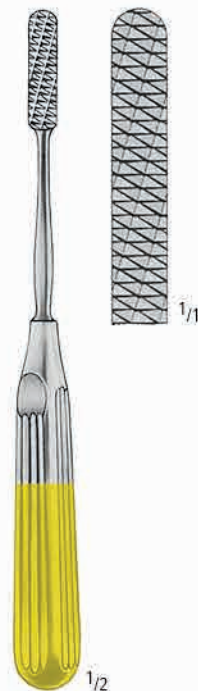

**COTTLE**  
KO 392/21  
21,0 cm/8 1/4"



**FOMON**  
KO 395/01-05  
20,0 cm/8"



KO 395/01



KO 395/02



KO 395/03



KO 395/04



KO 395/05



AA  
AB  
AC  
AD  
AE  
AF  
AK  
AL  
AO  
AP  
AR  
KA  
KL  
KM  
KO  
KU  
KYE  
X



**KO** NASE RHINOLOGY RINOLOGIA RHINOLOGIE RINOLOGIA

Feine Wundhaken  
 Delicate Hooks  
 Ganchos  
 Crochets très fins  
 Divaricatori sottili



**JOSEPH**  
**KO 400/01**  
 15,0 cm/6"



**JOSEPH**  
 16,0 cm/6<sup>1</sup>/<sub>4</sub>"



**KO 400/02**  
 2,0 mm



**KO 400/05**  
 5,0 mm



**KO 400/07**  
 7,0 mm



**KO 400/10**  
 10,0 mm



**COTTLE**  
**KO 402/16**  
 16,0 cm/6<sup>1</sup>/<sub>4</sub>"



**FOMON**  
**KO 403/17**  
 17,0 cm/6<sup>3</sup>/<sub>4</sub>"



**LANGE**  
**KO 404/22**  
 22,0 cm/8<sup>3</sup>/<sub>4</sub>"



**FOMON**  
**KO 405/16**  
 16,0 cm/6<sup>1</sup>/<sub>4</sub>"



**FREER**  
**KO 406/15**  
 15,0 cm/6"

NASE RHINOLOGY RINOLOGIA RHINOLOGIE RINOLOGIA

Feine Wundhaken  
Delicate Hooks  
Ganchos  
Crochets très fins  
Divaricatori sottili

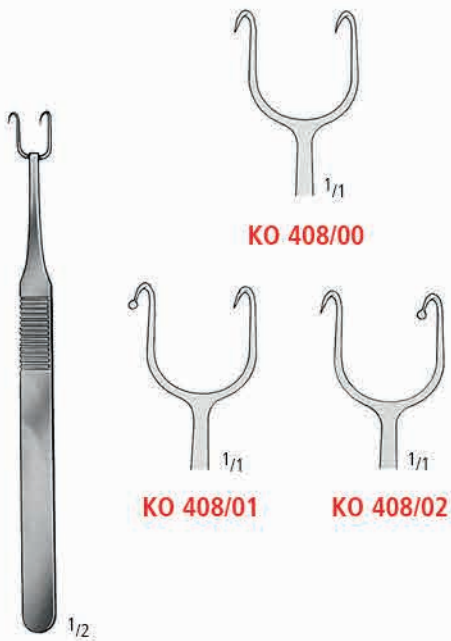

**COTTLE**  
14,0 cm/5½"



**COTTLE (MILLARD)**  
KO 409/00



**KILNER**  
KO 410/10



**COTTLE**  
KO 411/14  
14,0 cm/5½"



**COTTLE-NEIVERT**  
KO 412/20  
20,0 cm/8"



**CONVERSE**  
KO 413/12  
12,0 cm/4¾"



**MASING**  
KO 414/20  
20,0 cm/8"



**COTTLE**  
KO 415/15  
15,0 cm/6"



**COTTLE**  
KO 416/15  
15,0 cm/6"

AA  
AB  
AC  
AD  
AE  
AF  
AK  
AL  
AO  
AP  
AR  
KA  
KL  
KM  
KO  
KU  
KYE  
X

Instrumente zur Nasenplastik  
 Rhinoplastic Instruments  
 Instrumentos para la plástica nasal  
 Instruments pour la plastique nasale  
 Strumenti per la plastica nasale



**AUFRICHT (WALTER)**  
**KO 428/14**  
 13,5 cm/5<sup>1</sup>/<sub>4</sub>"

**AUFRICHT**  
**KO 430/45**  
 16,0 cm/6<sup>1</sup>/<sub>4</sub>"

**AUFRICHT**  
**KO 430/50**  
 mit Kaltlicht  
 with fibre optic illumination

**COTTLE**  
**KO 435/11**  
 11,0 cm/4<sup>1</sup>/<sub>3</sub>"

9,0 mm



**MC INDOE**  
**KO 442/09**  
 15,0 cm/6"

10,0 mm



**MC INDOE**  
**KO 442/10**  
 15,0 cm/6"



**BARSKY**  
**KO 443/15**  
 15,0 cm/6"



**HUMBY**  
**KO 444/12**  
 11,5 cm/ 4<sup>1</sup>/<sub>2</sub>"



**CONVERSE**  
 9,0 cm/3<sup>1</sup>/<sub>2</sub>"  
 9,5 x 18,00 mm **KO 445/18**  
 12,5 x 28,0 mm **KO 445/28**  
 13,5 x 41,0 mm **KO 445/41**  
 13,5 x 53,0 mm **KO 445/53**

NASE RHINOLOGY RINOLOGIA RHINOLOGIE RINOLOGIA

Küretten, Löffel, Messer  
 Sharp Currettes, Spoons, Knives  
 Curetas cortantes, Cucharillas, Cuchillos  
 Currettes tranchantes, Couteaux  
 Curette taglienti, Cucchiai, Coltelli



**KO 480/01**  
Fig. 1

**KO 480/02**  
Fig. 2

**KO 480/03**  
Fig. 3

**KO 480/04**  
Fig. 4

**KO 480/05**  
Fig. 5

**KO 480/06**  
Fig. 6



**COAKLEY**  
**KO 481/19**  
19,0 cm/7 1/2"

**FAULKNER**  
**KO 482/21**  
21,0 cm/8 1/4"

**MACKAY**  
**KO 483/21**  
21,0 cm/8 1/4"  
2,5 x 5,0 mm

**COAKLEY**  
**KO 480/01-06**  
17,0 cm/6 3/4"



**SEWALL**  
**KO 485/20**  
20,0 cm/8"

**PRATT**  
**KO 486/21**  
21,0 cm/8 1/4"

**MACKAY**  
**KO 489/21**  
21,0 cm/8 1/4"

**KO 490/20**  
20,0 cm/8"

**KUHN-BOLGER**  
55°  
**KO 492/55**  
19,0 cm/7 1/2"

**KUHN-BOLGER**  
90°  
**KO 492/90**  
19,0 cm/7 1/2"

AA  
AB  
AC  
AD  
AE  
AF  
AK  
AL  
AO  
AP  
AR  
KA  
KL  
KM  
**KO**  
KU  
KYE  
X



**KO** NASE RHINOLOGY RINOLOGIA RHINOLOGIE RINOLOGIA

Küretten, Löffel, Flach- und Hohlmeißel  
 Sharp Curettes, Spoons, Chisels and Gouges  
 Curetas cortantes, Cucharillas, Cinceles y Gubias  
 Curettes tranchantes, Ciseaux-burins et Gouges  
 Curette taglienti, Cucchiari, Scalpelli e Sgorbie



**UFFENDORDE**  
**KO 493/21**  
 21,0 cm/8<sup>1</sup>/<sub>4</sub>"



**UFFENDORDE**  
**KO 494/21**  
 21,0 cm/8<sup>1</sup>/<sub>4</sub>"



**HALLE**  
**KO 495/21**  
 21,0 cm/8<sup>1</sup>/<sub>4</sub>"



**FREER**  
**KO 602/04**  
 16,0 cm/6<sup>1</sup>/<sub>4</sub>"



**FREER**  
**KO 603/04**  
 16,0 cm/6<sup>1</sup>/<sub>4</sub>"



**WEST**  
**KO 604/04**  
 16,0 cm/6<sup>1</sup>/<sub>4</sub>"



**WEST**  
**KO 605/04**  
 16,0 cm/6<sup>1</sup>/<sub>4</sub>"



**FREER**  
**KO 606/06**  
 15,0 cm/6"



**BALLENGER**  
 16,0 cm/6<sup>1</sup>/<sub>4</sub>"



**KILLIAN**  
**KO 608/05**  
 17,0 cm/6<sup>3</sup>/<sub>4</sub>"



**KILLIAN-CLAUS**  
**KO 609/05**  
 17,0 cm/6<sup>3</sup>/<sub>4</sub>"



NASE RHINOLOGY RINOLOGIA RHINOLOGIE RINOLOGIA

Osteotome und Flachmeißel  
 Osteotomes and Chisels  
 Osteótomos y Cinceles  
 Ostéotomes et Ciseaux-burins  
 Osteotomi e Scalpelli



**COTTLE**  
18,0 cm/7"

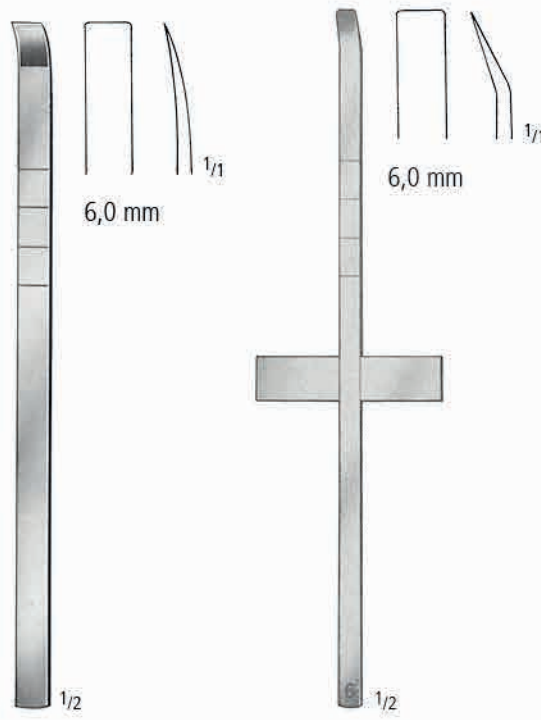

**COTTLE**  
**KO 611/06**  
18,0 cm/7"

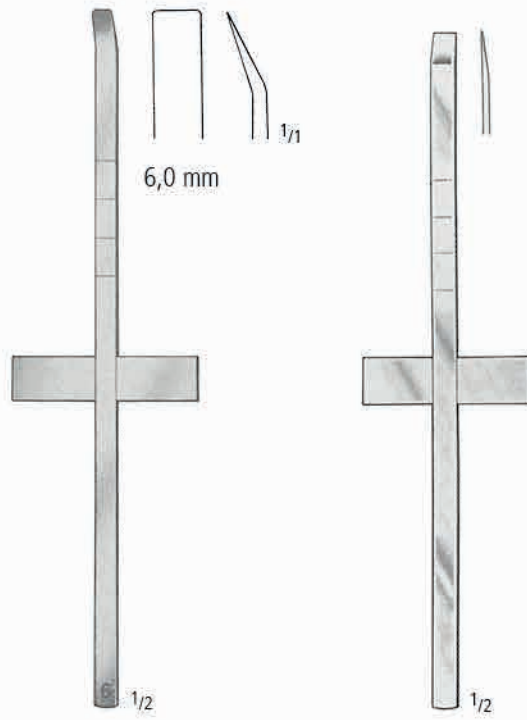

**COTTLE**  
18,0 cm/7"

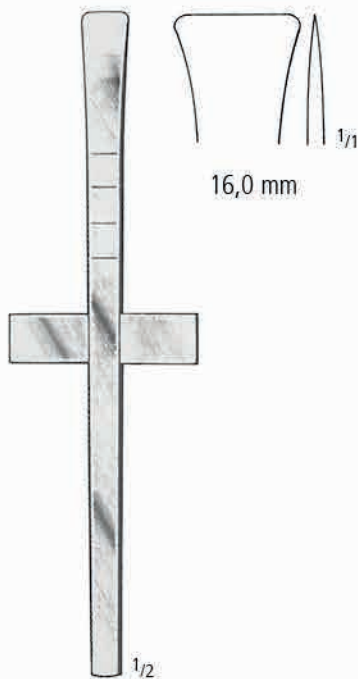

**COTTLE**  
**KO 614/16**  
18,0 cm/7"

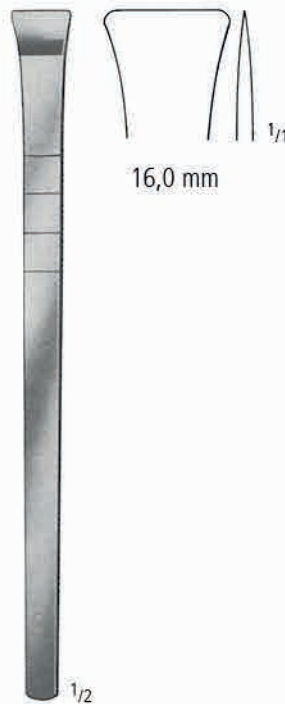

**COTTLE**  
**KO 615/16**  
18,0 cm/7"



**KO 617/02**  
18,0 cm/7"

AA  
AB  
AC  
AD  
AE  
AF  
AK  
AL  
AO  
AP  
AR  
KA  
KL  
KM  
**KO**  
KU  
KYE  
X

Osteotome  
Osteotomes  
Osteótomos  
Ostéotomes  
Osteotomi



**KO 618/20**  
2,0 mm



**KO 618/25**  
2,5 mm



**KO 619/22**  
2,2 mm



**KO 619/30**  
3,0 mm



**KO 618/30**  
3,0 mm



**KO 618/40**  
4,0 mm



**KO 619/40**  
4,0 mm

**NOLST-TRENITÉ  
MIKRO-OSTEOTOM**  
18,0 cm/7"



**KO 620/10**  
10,0 mm

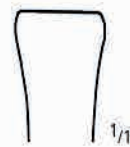

**KO 620/12**  
12,0 mm



**KO 620/14**  
14,0 mm

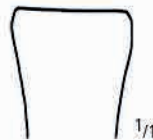

**KO 620/16**  
16,0 mm



**KO 620/18**  
18,0 mm

**NOLST-TRENITÉ  
OSTEOTOM**  
18,0 cm/7"

NASE RHINOLOGY RINOLOGIA RHINOLOGIE RINOLOGIA

Osteotome und Flachmeißel  
 Osteotomes and Chisels  
 Osteótomos y Cinceles  
 Ostéotomes et Ciseaux-burins  
 Osteotomi e Scalpelli

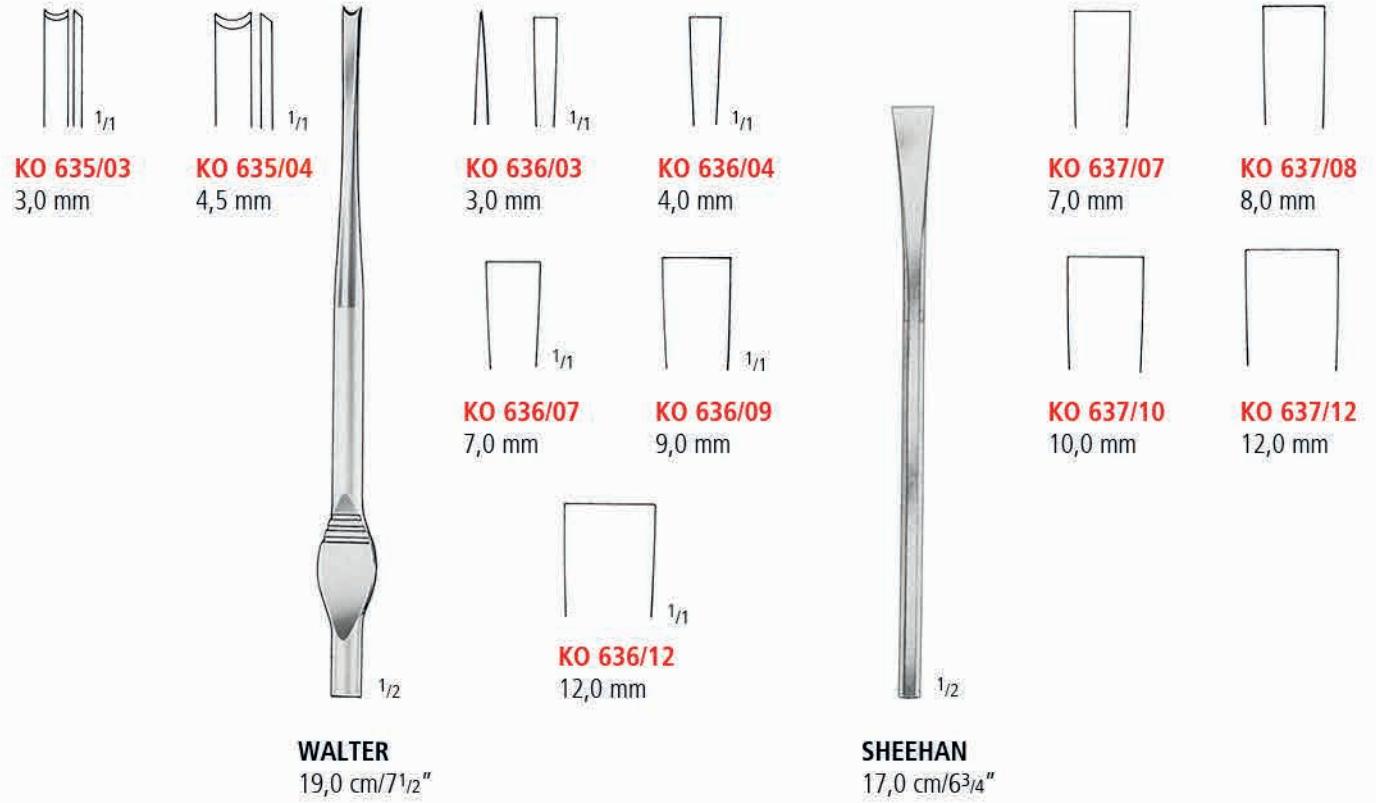

**KO 635/03**  
3,0 mm

**KO 635/04**  
4,5 mm

**KO 636/03**  
3,0 mm

**KO 636/04**  
4,0 mm

**KO 636/07**  
7,0 mm

**KO 636/09**  
9,0 mm

**KO 636/12**  
12,0 mm

**WALTER**  
19,0 cm/7½"

**KO 637/07**  
7,0 mm

**KO 637/08**  
8,0 mm

**KO 637/10**  
10,0 mm

**KO 637/12**  
12,0 mm

**SHEEHAN**  
17,0 cm/6¾"

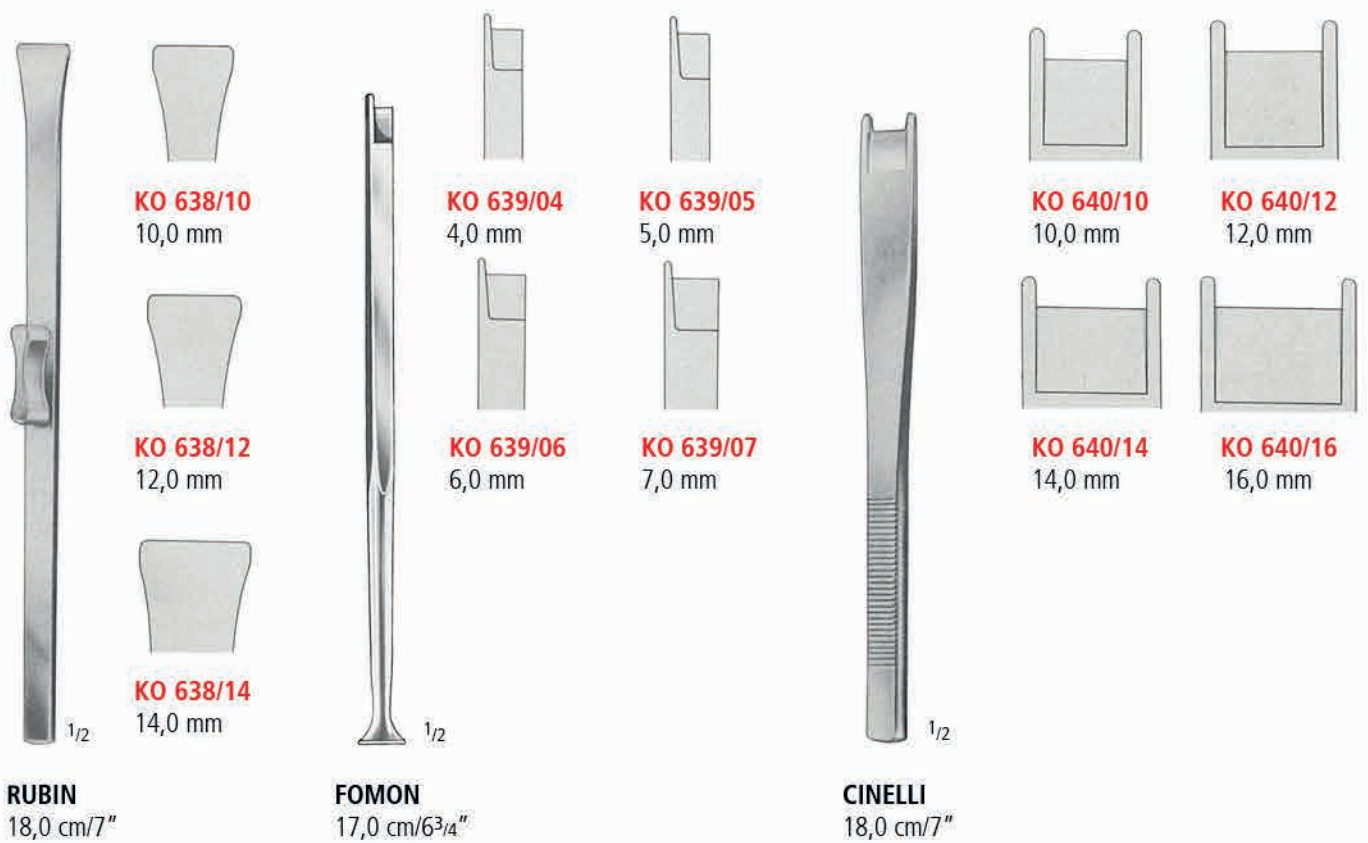

**KO 638/10**  
10,0 mm

**KO 638/12**  
12,0 mm

**KO 638/14**  
14,0 mm

**RUBIN**  
18,0 cm/7"

**KO 639/04**  
4,0 mm

**KO 639/05**  
5,0 mm

**KO 639/06**  
6,0 mm

**KO 639/07**  
7,0 mm

**FOMON**  
17,0 cm/6¾"

**KO 640/10**  
10,0 mm

**KO 640/12**  
12,0 mm

**KO 640/14**  
14,0 mm

**KO 640/16**  
16,0 mm

**CINELLI**  
18,0 cm/7"

AA  
AB  
AC  
AD  
AE  
AF  
AK  
AL  
AO  
AP  
AR  
KA  
KL  
KM  
KO  
KU  
KYE  
X

Osteotome und Flachmeißel  
 Osteotomes and Chisels  
 Osteótomos y Cinceles  
 Ostéotomes et Ciseaux-burins  
 Osteotomi e Scalpelli



**MASING**  
**KO 643/00**  
 17,5 cm/7"



**MASING**  
**KO 643/01**  
 17,5 cm/7"



**MASING**  
**KO 643/02**  
 17,5 cm/7"



**SILVER**  
**KO 644/00**  
 18,0 cm/7"



**SILVER**  
**KO 644/01**  
 18,0 cm/7"

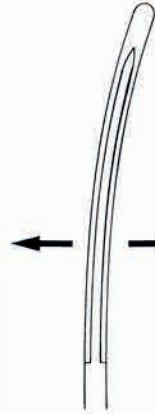

**SILVER**  
**KO 644/02**  
 18,0 cm/7"



**NEIVERT**  
**KO 645/00**  
 20,0 cm/8"



**ANDERSON-NEIVERT**  
**KO 645/01**  
 20,0 cm/8"



**ANDERSON-NEIVERT**  
**KO 645/02**  
 20,0 cm/8"



**CONVERSE**  
**KO 646/01**



**CONVERSE**  
**KO 646/02**



**CONVERSE**  
**KO 646/00**  
 19,0 cm/7 1/2"



**OBWEGESER**  
**KO 647/02**  
 18,5 cm/7 1/3"



NASE RHINOLOGY RINOLOGIA RHINOLOGIE RINOLOGIA

Ringmesser  
 Adenoid Currettes  
 Cuchillos para vegetaciones adenoides  
 Couteaux à végétations adénoïdes  
 Coltelli per vegetazioni adenoidee



1/1 Fig. 0  
**KO 700/00**  
**KO 701/00**



1/1 Fig. 1  
**KO 700/01**  
**KO 701/01**



1/1 Fig. 2  
**KO 700/02**  
**KO 701/02**



1/1 Fig. 3  
**KO 700/03**  
**KO 701/03**



1/1 Fig. 4  
**KO 700/04**  
**KO 701/04**



1/1 Fig. 5  
**KO 700/05**  
**KO 701/05**



1/1 Fig. 6  
**KO 700/06**  
**KO 701/06**



**BECKMANN**  
**KO 700/01-06**  
 22,0 cm/8<sup>3</sup>/<sub>4</sub>"



**BECKMANN (NEGUS)**  
**KO 701/01-06**  
 22,0 cm/8<sup>3</sup>/<sub>4</sub>"



**BARNHILL**  
**KO 702/01-04**  
 22,0 cm/8<sup>3</sup>/<sub>4</sub>"

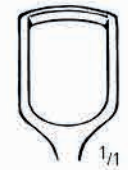

1/1  
**KO 702/01**

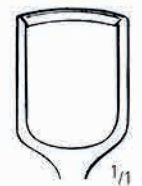

1/1  
**KO 702/02**

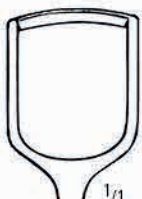

1/1  
**KO 702/03**



1/1  
**KO 702/04**

AA  
 AB  
 AC  
 AD  
 AE  
 AF  
 AG  
 AH  
 AI  
 AJ  
 AK  
 AL  
 AM  
 AN  
 AO  
 AP  
 AQ  
 AR  
 AS  
 AT  
 AU  
 AV  
 AW  
 AX  
 AY  
 AZ  
 BA  
 BB  
 BC  
 BD  
 BE  
 BF  
 BG  
 BH  
 BI  
 BJ  
 BK  
 BL  
 BM  
 BN  
 BO  
 BP  
 BQ  
 BR  
 BS  
 BT  
 BU  
 BV  
 BW  
 BX  
 BY  
 BZ  
 CA  
 CB  
 CC  
 CD  
 CE  
 CF  
 CG  
 CH  
 CI  
 CJ  
 CK  
 CL  
 CM  
 CN  
 CO  
 CP  
 CQ  
 CR  
 CS  
 CT  
 CU  
 CV  
 CW  
 CX  
 CY  
 CZ  
 DA  
 DB  
 DC  
 DD  
 DE  
 DF  
 DG  
 DH  
 DI  
 DJ  
 DK  
 DL  
 DM  
 DN  
 DO  
 DP  
 DQ  
 DR  
 DS  
 DT  
 DU  
 DV  
 DW  
 DX  
 DY  
 DZ  
 EA  
 EB  
 EC  
 ED  
 EE  
 EF  
 EG  
 EH  
 EI  
 EJ  
 EK  
 EL  
 EM  
 EN  
 EO  
 EP  
 EQ  
 ER  
 ES  
 ET  
 EU  
 EV  
 EW  
 EX  
 EY  
 EZ  
 FA  
 FB  
 FC  
 FD  
 FE  
 FF  
 FG  
 FH  
 FI  
 FJ  
 FK  
 FL  
 FM  
 FN  
 FO  
 FP  
 FQ  
 FR  
 FS  
 FT  
 FU  
 FV  
 FW  
 FX  
 FY  
 FZ  
 GA  
 GB  
 GC  
 GD  
 GE  
 GF  
 GG  
 GH  
 GI  
 GJ  
 GK  
 GL  
 GM  
 GN  
 GO  
 GP  
 GQ  
 GR  
 GS  
 GT  
 GU  
 GV  
 GW  
 GX  
 GY  
 GZ  
 HA  
 HB  
 HC  
 HD  
 HE  
 HF  
 HG  
 HH  
 HI  
 HJ  
 HK  
 HL  
 HM  
 HN  
 HO  
 HP  
 HQ  
 HR  
 HS  
 HT  
 HU  
 HV  
 HW  
 HX  
 HY  
 HZ  
 IA  
 IB  
 IC  
 ID  
 IE  
 IF  
 IG  
 IH  
 II  
 IJ  
 IK  
 IL  
 IM  
 IN  
 IO  
 IP  
 IQ  
 IR  
 IS  
 IT  
 IU  
 IV  
 IW  
 IX  
 IY  
 IZ  
 JA  
 JB  
 JC  
 JD  
 JE  
 JF  
 JG  
 JH  
 JI  
 JJ  
 JK  
 JL  
 JM  
 JN  
 JO  
 JP  
 JQ  
 JR  
 JS  
 JT  
 JU  
 JV  
 JW  
 JX  
 JY  
 JZ  
 KA  
 KB  
 KC  
 KD  
 KE  
 KF  
 KG  
 KH  
 KI  
 KJ  
 KK  
 KL  
 KM  
 KN  
 KO  
 KP  
 KQ  
 KR  
 KS  
 KT  
 KU  
 KV  
 KW  
 KX  
 KY  
 KZ  
 LA  
 LB  
 LC  
 LD  
 LE  
 LF  
 LG  
 LH  
 LI  
 LJ  
 LK  
 LL  
 LM  
 LN  
 LO  
 LP  
 LQ  
 LR  
 LS  
 LT  
 LU  
 LV  
 LW  
 LX  
 LY  
 LZ  
 MA  
 MB  
 MC  
 MD  
 ME  
 MF  
 MG  
 MH  
 MI  
 MJ  
 MK  
 ML  
 MM  
 MN  
 MO  
 MP  
 MQ  
 MR  
 MS  
 MT  
 MU  
 MV  
 MW  
 MX  
 MY  
 MZ  
 NA  
 NB  
 NC  
 ND  
 NE  
 NF  
 NG  
 NH  
 NI  
 NJ  
 NK  
 NL  
 NM  
 NN  
 NO  
 NP  
 NQ  
 NR  
 NS  
 NT  
 NU  
 NV  
 NW  
 NX  
 NY  
 NZ  
 OA  
 OB  
 OC  
 OD  
 OE  
 OF  
 OG  
 OH  
 OI  
 OJ  
 OK  
 OL  
 OM  
 ON  
 OO  
 OP  
 OQ  
 OR  
 OS  
 OT  
 OU  
 OV  
 OW  
 OX  
 OY  
 OZ  
 PA  
 PB  
 PC  
 PD  
 PE  
 PF  
 PG  
 PH  
 PI  
 PJ  
 PK  
 PL  
 PM  
 PN  
 PO  
 PP  
 PQ  
 PR  
 PS  
 PT  
 PU  
 PV  
 PW  
 PX  
 PY  
 PZ  
 QA  
 QB  
 QC  
 QD  
 QE  
 QF  
 QG  
 QH  
 QI  
 QJ  
 QK  
 QL  
 QM  
 QN  
 QO  
 QP  
 QQ  
 QR  
 QS  
 QT  
 QU  
 QV  
 QW  
 QX  
 QY  
 QZ  
 RA  
 RB  
 RC  
 RD  
 RE  
 RF  
 RG  
 RH  
 RI  
 RJ  
 RK  
 RL  
 RM  
 RN  
 RO  
 RP  
 RQ  
 RR  
 RS  
 RT  
 RU  
 RV  
 RW  
 RX  
 RY  
 RZ  
 SA  
 SB  
 SC  
 SD  
 SE  
 SF  
 SG  
 SH  
 SI  
 SJ  
 SK  
 SL  
 SM  
 SN  
 SO  
 SP  
 SQ  
 SR  
 SS  
 ST  
 SU  
 SV  
 SW  
 SX  
 SY  
 SZ  
 TA  
 TB  
 TC  
 TD  
 TE  
 TF  
 TG  
 TH  
 TI  
 TJ  
 TK  
 TL  
 TM  
 TN  
 TO  
 TP  
 TQ  
 TR  
 TS  
 TT  
 TU  
 TV  
 TW  
 TX  
 TY  
 TZ  
 UA  
 UB  
 UC  
 UD  
 UE  
 UF  
 UG  
 UH  
 UI  
 UJ  
 UK  
 UL  
 UM  
 UN  
 UO  
 UP  
 UQ  
 UR  
 US  
 UT  
 UY  
 UZ  
 VA  
 VB  
 VC  
 VD  
 VE  
 VF  
 VG  
 VH  
 VI  
 VJ  
 VK  
 VL  
 VM  
 VN  
 VO  
 VP  
 VQ  
 VR  
 VS  
 VT  
 VU  
 VV  
 VW  
 VX  
 VY  
 VZ  
 WA  
 WB  
 WC  
 WD  
 WE  
 WF  
 WG  
 WH  
 WI  
 WJ  
 WK  
 WL  
 WM  
 WN  
 WO  
 WP  
 WQ  
 WR  
 WS  
 WT  
 WU  
 WV  
 WW  
 WX  
 WY  
 WZ  
 XA  
 XB  
 XC  
 XD  
 XE  
 XF  
 XG  
 XH  
 XI  
 XJ  
 XK  
 XL  
 XM  
 XN  
 XO  
 XP  
 XQ  
 XR  
 XS  
 XT  
 XU  
 XV  
 XW  
 XX  
 XY  
 XZ  
 YA  
 YB  
 YC  
 YD  
 YE  
 YF  
 YG  
 YH  
 YI  
 YJ  
 YK  
 YL  
 YM  
 YN  
 YO  
 YP  
 YQ  
 YR  
 YS  
 YT  
 YU  
 YV  
 YW  
 YX  
 YZ  
 ZA  
 ZB  
 ZC  
 ZD  
 ZE  
 ZF  
 ZG  
 ZH  
 ZI  
 ZJ  
 ZK  
 ZL  
 ZM  
 ZN  
 ZO  
 ZP  
 ZQ  
 ZR  
 ZS  
 ZT  
 ZU  
 ZV  
 ZW  
 ZX  
 ZY  
 ZZ



Ringmesser, Tonsillotome  
 Adenoid Curettes, Adenotomes  
 Cuchillos para vegetaciones adenoideas, Adenótomos  
 Couteaux à végétations adénoïdes, Adénotomes  
 Coltelli per vegetazioni adenoidee, Adenotomi

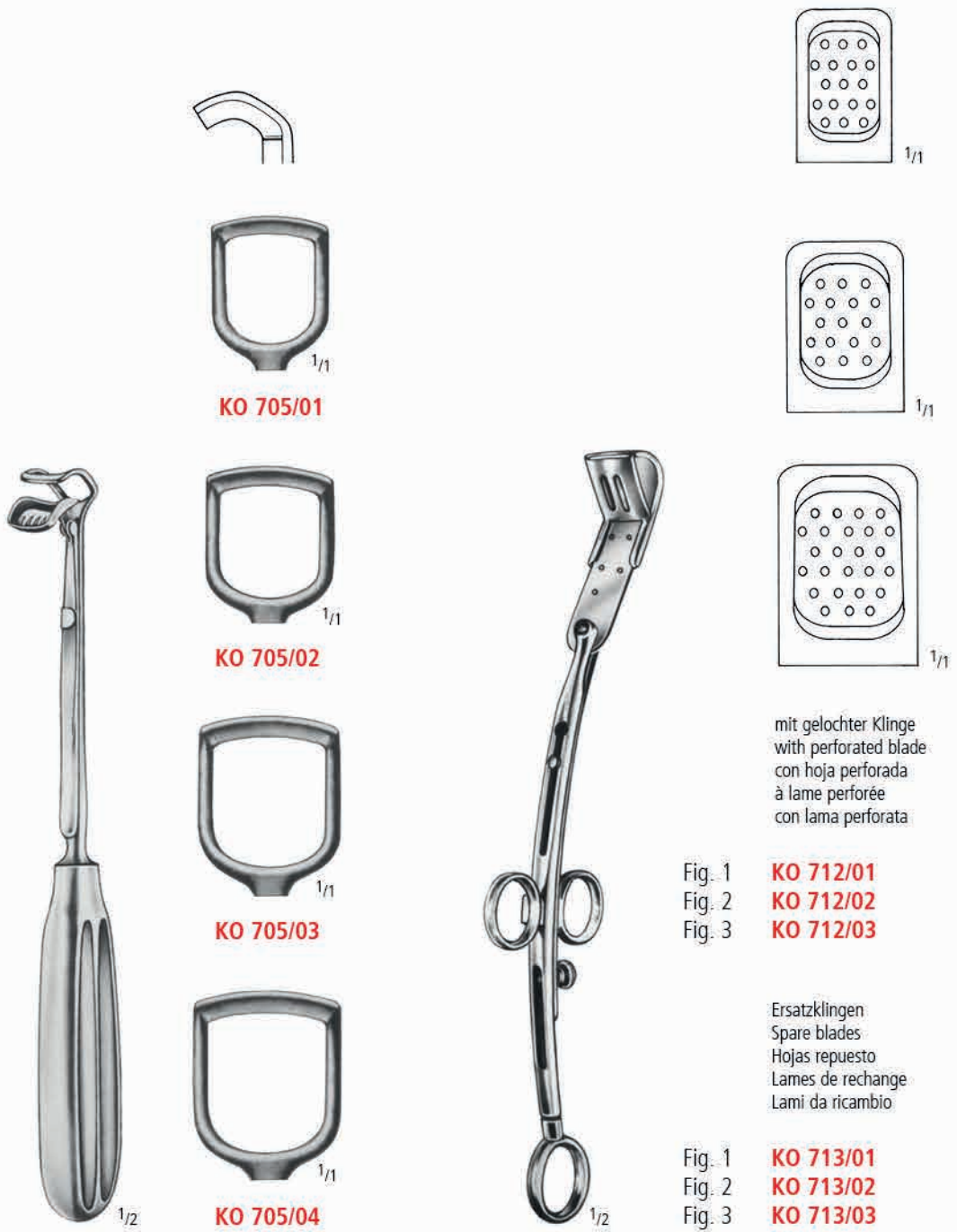

**ST. CLAIR-THOMPSON**  
**KO 705/01-04**  
 21,0 cm/8 1/4"

**LA FORCE**  
 25,0 cm/10"

mit gelochter Klinge  
 with perforated blade  
 con hoja perforada  
 à lame perforée  
 con lama perforata

Fig. 1 **KO 712/01**  
 Fig. 2 **KO 712/02**  
 Fig. 3 **KO 712/03**

Ersatzklingen  
 Spare blades  
 Hojas repuesto  
 Lames de rechange  
 Lami da ricambio

Fig. 1 **KO 713/01**  
 Fig. 2 **KO 713/02**  
 Fig. 3 **KO 713/03**

Septumrichtzangen  
 Septum Straightening Forceps  
 Pinzas para enderezar el tabique nasal  
 Pincas pour la cloison nasale  
 Pinze per raddrizzare il setto nasale



**ASCH**  
**KO 750/23**  
 23,0 cm/9"



**WALSHAM**  
 23,0 cm/9"



**KO 751/00**



**KO 751/01**



**KO 751/02**

AA  
 AB  
 AC  
 AD  
 AE  
 AF  
 AK  
 AL  
 AO  
 AP  
 AR  
 KA  
 KL  
 KM  
 KU  
 KYE  
 X

**KO**

Instrumente zur Nasenplastik  
 Rhinoplastic Instruments  
 Instrumentos para la plástica nasal  
 Instruments pour la plastique nasale  
 Strumenti per la plastica nasale



**RUBIN**  
**KO 753/20**  
 20,0 cm/8"



**KRESSNER**  
 20,0 cm/8"



**KO 754/60**  
 2,5 x 60 mm



**KO 754/70**  
 4 x 70 mm



**KO 754/75**  
 5 x 75 mm

Knorpelquetscher  
 Cartilage crusher  
 Trituradora de sustancia cartilaginosa  
 Presse pour matière cartilagineuse  
 Trita cartilagine



**COTTLE**  
**KO 756/00**



**BOIES**  
**KO 757/18**  
 18,0 cm/7"



**GOLDMANN**  
**KO 758/20**  
 20,0 cm/8"

Hämmer  
Mallets  
Martillos  
Maillets  
Martelli



Ø 25,0 mm  
140 g

mit auswechselbaren Backen  
with interchangeable discs  
con tapas intercambiables  
avec plaques interchangeables  
con placche intercambiabili

1/2

**KO 800/18**  
18,0 cm/7"

**KO 800/99**

Ferrozellbacken allein, paarweise  
Ferrozell Faces only, pair  
Tapas de Ferrozell sueltas, par  
Plaques en Ferrozell seules, paire  
Placche in Ferrozell sole, a paia



Ø 30,0 mm  
240 g

1/2

**COTTLE**  
**KO 801/19**  
19,0 cm/7 1/2"



Ø 25,0 mm  
320 g

mit auswechselbaren Backen  
with interchangeable discs  
con tapas intercambiables  
avec plaques interchangeables  
con placche intercambiabili

1/2

**KA 556/32**  
18,0 cm/7"

**KA 556/99**

Nylonbacken allein, paarweise  
Nylon Faces only, pair  
Tapas de Nylon sueltas, par  
Plaques en Nylon seules, paire  
Placche in Nylon sole, a paia

Weitere Hämmer siehe Gruppe KA  
More Mallets in chapter KA  
Para otras Martillos ver seccion KA  
D'autres Maillets groupe KA  
Altre Martelli vedi gruppo KA

AA  
AB  
AC  
AD  
AE  
AF  
AK  
AL  
AO  
AP  
AR  
KA  
KL  
KM  
KU  
KYE  
X

KO

Wundhaken  
 Retractors  
 Separadores  
 Ecarteurs  
 Divaricatori



**BRUENINGS-BRUNK**  
**KO 820/19**  
 19,0 cm/7½"



**SCHÄFER**  
**KO 821/23**  
 23,0 cm/9"

Weitere Wundhaken siehe Gruppe AK  
 More Retractors in chapter AK  
 Para otras Separadores ver seccion AK  
 D'autres Ecarteurs groupe AK  
 Altre Divaricatori vedi gruppo AK



VERSCHIEDENES  
VARIOUS ITEMS  
DIVERSOS ARTICULOS  
ARTICLES DIVERS  
ARTICOLI DIVERSI

KU

nopa<sup>®</sup> instruments





Ø x h		
40 x 19 mm	0,05 l	<b>KU 300/04</b>
61 x 30 mm	0,07 l	<b>KU 300/06</b>
80 x 40 mm	0,14 l	<b>KU 300/08</b>
116 x 50 mm	0,35 l	<b>KU 300/11</b>
128 x 55 mm	0,45 l	<b>KU 300/12</b>
147 x 65 mm	0,70 l	<b>KU 300/14</b>



<b>KU 301/01</b>	= 0,25 l
<b>KU 301/02</b>	= 0,50 l
<b>KU 301/03</b>	= 1,00 l
<b>KU 301/04</b>	= 2,00 l

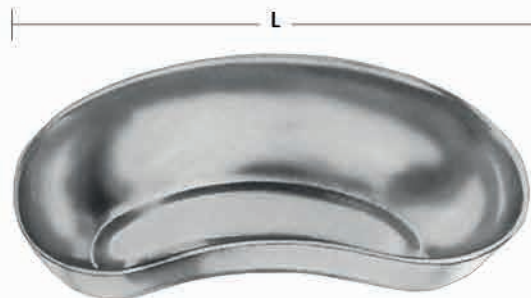

L = 170 mm	<b>KU 302/17</b>
L = 200 mm	<b>KU 302/20</b>
L = 250 mm	<b>KU 302/25</b>
L = 275 mm	<b>KU 302/27</b>



**KU 303/65** →

**KU 303/00**  
Ø = 65 mm



**KU 304/50** = 50 x 25 x 4,5 mm  
**KU 304/65** = 65 x 42 x 8,0 mm  
**KU 304/75** = 75 x 25 x 4,5 mm



**KU 306/15** = 150 x 95 x 13 mm

AA  
AB  
AC  
AD  
AE  
AF  
AK  
AL  
AO  
AP  
AR  
KA  
KL  
KM  
KO  
KYE  
X

**KU**



l x b x h	
230 x 155 x 30 mm	<b>KU 307/23</b>
300 x 175 x 30 mm	<b>KU 307/30</b>
300 x 175 x 40 mm	<b>KU 308/30</b>
350 x 240 x 36 mm	<b>KU 308/35</b>
400 x 300 x 50 mm	<b>KU 308/50</b>

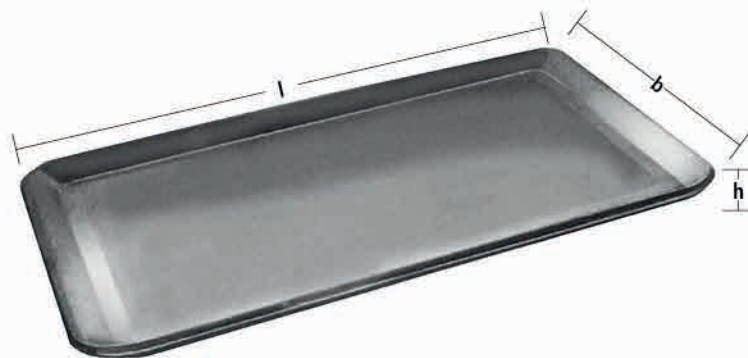

l x b x h	
210 x 160 x 10 mm	<b>KU 309/21</b>
240 x 180 x 10 mm	<b>KU 309/24</b>
310 x 150 x 10 mm	<b>KU 309/31</b>
310 x 210 x 10 mm	<b>KU 310/31</b>
350 x 240 x 10 mm	<b>KU 310/35</b>
400 x 270 x 20 mm	<b>KU 310/40</b>
420 x 280 x 10 mm	<b>KU 310/42</b>

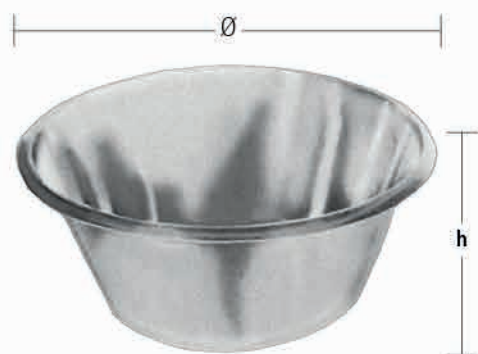

Ø x h	l	
165 x 60 mm	0,75	<b>KU 311/16</b>
175 x 70 mm	1,00	<b>KU 311/17</b>
220 x 80 mm	2,00	<b>KU 311/22</b>
225 x 90 mm	2,50	<b>KU 311/23</b>
240 x 110 mm	3,00	<b>KU 311/24</b>
275 x 115 mm	4,50	<b>KU 311/27</b>
290 x 125 mm	6,00	<b>KU 311/29</b>
310 x 120 mm	6,00	<b>KU 311/31</b>
345 x 125 mm	8,50	<b>KU 311/34</b>
380 x 130 mm	11,00	<b>KU 311/38</b>



l x b x h	
16,5 x 9,0 x 3,5 cm	<b>KU 312/16</b>
20,0 x 10,0 x 5,0 cm	<b>KU 312/20</b>
22,0 x 15,0 x 5,0 cm	<b>KU 312/22</b>
26,0 x 15,0 x 5,0 cm	<b>KU 312/26</b>
30,5 x 20,5 x 5,0 cm	<b>KU 312/30</b>

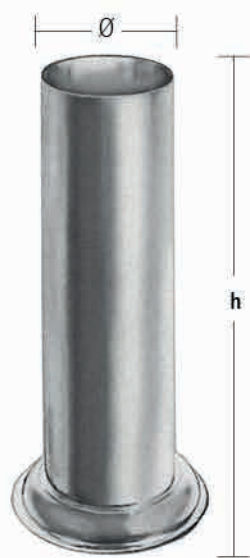

Ø x h	
30 x 90 mm	<b>KU 314/09</b>
50 x 100 mm	<b>KU 314/10</b>
50 x 130 mm	<b>KU 314/13</b>
50 x 175 mm	<b>KU 314/17</b>
75 x 100 mm	<b>KU 315/10</b>
75 x 130 mm	<b>KU 315/13</b>
75 x 175 mm	<b>KU 315/17</b>

AA  
AB  
AC  
AD  
AE  
AF  
AK  
AL  
AO  
AP  
AR  
KA  
KL  
KM  
KO  
KYE  
X

**KU**





**MAYO**  
**KU 318/14**  
 14,0 cm/5<sup>1</sup>/<sub>2</sub>"



**MAYO**  
**KU 320/14**  
 14,0 cm/5<sup>1</sup>/<sub>2</sub>"



**CHEATE**  
**KU 321/27**  
 27,0 cm/10<sup>1</sup>/<sub>2</sub>"

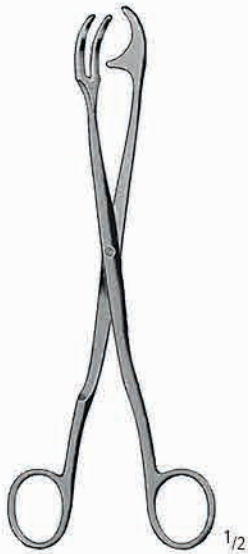

**ROGGE**  
**KU 322/23**  
 23,0 cm/9"



**PYE-SMITH (HARRISON)**  
**KU 323/25** 25,0 cm/10"  
**KU 323/30** 30,0 cm/12"

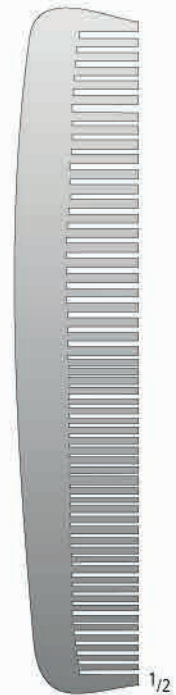

**KU 325/18**  
 18,0 cm/7"

container system  
container system  
sistema de contenedor  
système de conteneur  
sistema del contenitore

**KYE**

**nopa**<sup>®</sup> instruments

Unser komplettes Container Programm finden Sie  
in unserem Katalog „Container System“.

For our complete range of sterilizing containers  
kindly refer to our catalogue „Container system“.

Para nuestro gama completa de contenedores,  
por favor consulte nuestro catálogo de  
„Sistema de contenedor“.

Pour notre gamme complet des conteneurs, consultez  
notre catalogue „Système de conteneur“.

Per nostro assortimento completo di contenitore,  
consultare il nostro catalogo „Sistema del Contenitore“.



COLOR SAMPLE BOARD



Erklärung zu unseren Symbolen • Explanation of our symbols • Explicación de nuestros símbolos  
• Explication de nos figures • Spiegazione dei nostri simboli

Wanne • Bottom • Fondo • Fond • Fondo



Wanne nicht gelocht  
Bottom not perforated  
Fondo no perforado  
Fond non poinçonné  
Fondo non perforato



Wanne gelocht  
Bottom perforated  
Fondo perforado  
Fond poinçonné  
Fondo perforato

Deckel • Lid • Tapa • Couvercle • Coperchio



Deckel gelocht  
Lid perforated  
Tapa perforada  
Couvercle poinçonné  
Coperchio perforato



Sicherheitsdeckel  
Safety lid  
Tapa de seguridad  
Couvercle de sécurité  
Coperchio di sicurezza



Deckel nicht gelocht  
Lid not perforated  
Tapa no perforada  
Couvercle non poinçonné  
Coperchio non perforato

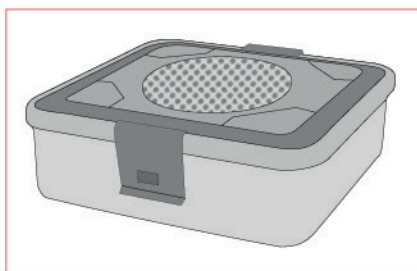

Zur Verwendung mit Sterilisationscontainern  
For use with sterilization containers  
Por uso con contenedores de esterilización  
Pour l'usage avec des conteneurs de sterilisation  
Per l'uso con contenitori di sterilizzazione

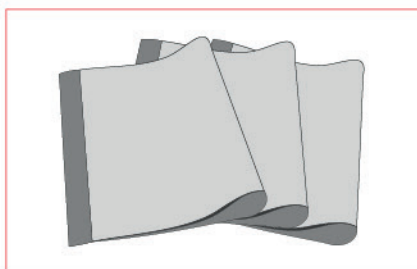

Zur Verwendung mit Weichverpackung  
For the use with soft packaging materials  
Por uso con envase blando  
Pour l'usage avec des emballages mous  
Per l'uso con imballaggio blando



**1/2**  
Container

Deckel gelocht, allein  
Lid perforated, only  
Tapa perforada, suelta  
Couvercle poinçonné, seul  
Coperchio perforato, solo



**L(mm)**   **B(mm)**  
285   280



Sicherheitsdeckel alleine, nur zur Verwendung mit Deckel gelocht  
Safety lid only, only for use with lid perforated  
Tapa de seguridad suelta, sólo para uso con tapa perforada  
Couvercle de sécurité seul, utilisation uniquement avec couvercle poinçonné  
Coperchio di sicurezza solo, solo per uso con coperchio perforato



**L(mm)**   **B(mm)**  
285   280



Deckel nicht gelocht, allein  
Lid not perforated, only  
Tapa no perforada, suelta  
Couvercle non poinçonné, seul  
Coperchio non perforato, solo



**L(mm)**   **B(mm)**  
285   280





Bestellinformation: Wanne + Deckel  
 Order information: Bottom + Lid  
 Información de pedido: Fondo + Tapa  
 Information de commande: Fond + Couverture  
 Informazione dell'ordine: Fondo + Coperchio

**1/2**  
**Container**

KYE  
 SK  
 KYE  
 SK  
 KYE  
 SK  
 SU



Wanne gelocht, allein  
 Bottom perforated, only  
 Fondo perforado, suelto  
 Fond poinçonné, seul  
 Fondo perforato, solo



Wanne nicht gelocht, allein  
 Bottom not perforated, only  
 Fondo no perforado, suelto  
 Fond non poinçonné, seul  
 Fondo non perforato, solo



L(mm)	B(mm)	H(mm)	
285	280	100	<b>KYE 284/10</b>
285	280	135	<b>KYE 284/13</b>
285	280	150	<b>KYE 284/15</b>
285	280	200	<b>KYE 284/20</b>
285	280	260	<b>KYE 284/26</b>

L(mm)	B(mm)	H(mm)	
285	280	100	<b>KYE 286/10</b>
285	280	135	<b>KYE 286/13</b>
285	280	150	<b>KYE 286/15</b>
285	280	200	<b>KYE 286/20</b>
285	280	260	<b>KYE 286/26</b>



L(mm)	B(mm)	H(mm)	
255	245	30	<b>SK 105/03</b>
255	245	50	<b>SK 105/05</b>
255	245	60	<b>SK 105/06</b>
255	245	70	<b>SK 105/07</b>
255	245	100	<b>SK 105/10</b>

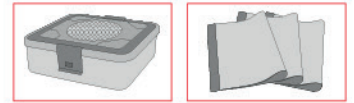

L(mm)	B(mm)	
255	245	<b>SK 105/50</b>

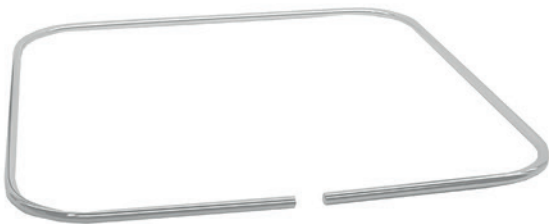
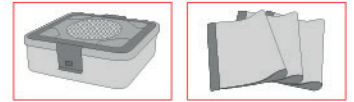

L(mm)	B(mm)	
255	255	<b>SK 105/61</b>

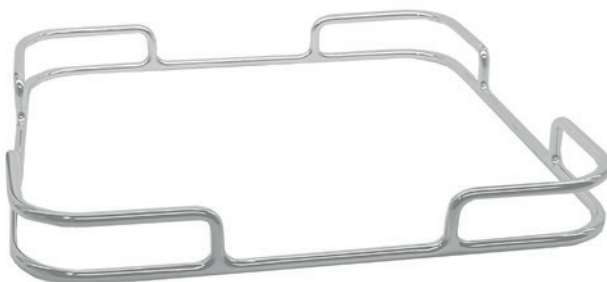

L(mm)	B(mm)	H(mm)	
255	255	30	<b>SK 105/62</b>





L(mm)	B(mm)	H(mm)	
255	245	130	<b>SK 105/71</b>
255	245	180	<b>SK 105/72</b>
255	245	230	<b>SK 105/73</b>



Lochblechsiebkorb  
Perforated steel basket  
Cestilla de acero perforado  
Panier d'acier poinçonné  
Cestello d'acciaio perforato



L(mm)	B(mm)	H(mm)	
255	245	50	<b>SK 110/05</b>
255	245	60	<b>SK 110/06</b>
255	245	70	<b>SK 110/07</b>
255	245	100	<b>SK 110/10</b>



Siebdeckel  
Top for basket  
Tapa para cestilla  
Couvercle pour panier  
Coperchio per cestello



L(mm)	B(mm)	
255	245	<b>SK 110/50</b>

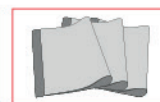



**3/4**  
Container



Deckel gelocht, allein  
Lid perforated, only  
Tapa perforada, suelta  
Couvercle poinçonné, seul  
Coperchio perforato, solo



**L(mm)**   **B(mm)**  
465   280



Sicherheitsdeckel alleine, nur zur Verwendung mit Deckel gelocht  
Safety lid only, only for use with lid perforated  
Tapa de seguridad suelta, sólo para uso con tapa perforada  
Couvercle de sécurité seul, utilisation uniquement avec couvercle poinçonné  
Coperchio di sicurezza solo, solo per uso con coperchio perforato



**L(mm)**   **B(mm)**  
465   280



Deckel nicht gelocht, allein  
Lid not perforated, only  
Tapa no perforada, suelta  
Couvercle non poinçonné, seul  
Coperchio non perforato, solo



**L(mm)**   **B(mm)**  
465   280



Bestellinformation: Wanne + Deckel  
 Order information: Bottom + Lid  
 Información de pedido: Fondo + Tapa  
 Information de commande: Fond + Couvercle  
 Informazione dell'ordine: Fondo + Coperchio

**3/4**  
**Container**

KYE  
 SK  
**KYE**  
 SK  
 KYE  
 SK  
 SU



Wanne gelocht, allein  
 Bottom perforated, only  
 Fondo perforado, suelto  
 Fond poinçonné, seul  
 Fondo perforato, solo



Wanne nicht gelocht, allein  
 Bottom not perforated, only  
 Fondo no perforado, suelto  
 Fond non poinçonné, seul  
 Fondo non perforato, solo



L(mm)	B(mm)	H(mm)	
465	280	100	<b>KYE 282/10</b>
465	280	135	<b>KYE 282/13</b>
465	280	150	<b>KYE 282/15</b>

L(mm)	B(mm)	H(mm)	
465	280	100	<b>KYE 283/10</b>
465	280	135	<b>KYE 283/13</b>
465	280	150	<b>KYE 283/15</b>





L(mm)	B(mm)	H(mm)	
405	255	30	<b>SK 205/03</b>
405	255	50	<b>SK 205/05</b>
405	255	60	<b>SK 205/06</b>
405	255	70	<b>SK 205/07</b>
405	255	100	<b>SK 205/10</b>

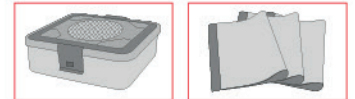

L(mm)	B(mm)	
405	255	<b>SK 205/50</b>

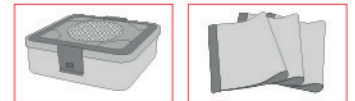

L(mm)	B(mm)	
405	255	<b>SK 205/61</b>

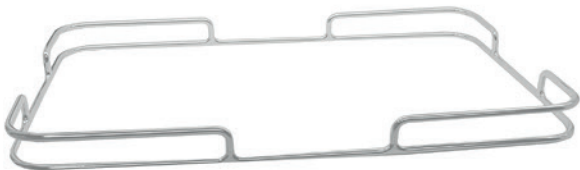
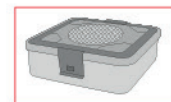

L(mm)	B(mm)	H(mm)	
405	255	30	<b>SK 205/62</b>

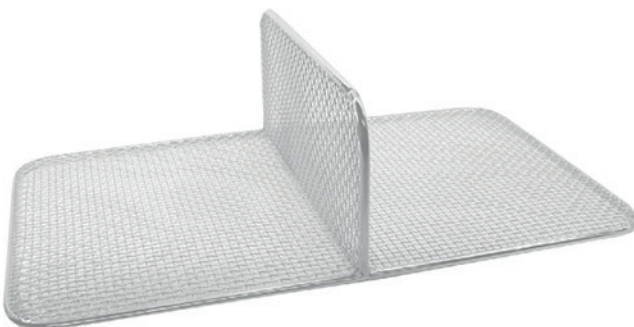

L(mm)	B(mm)	H(mm)	
405	250	130	<b>SK 205/71</b>



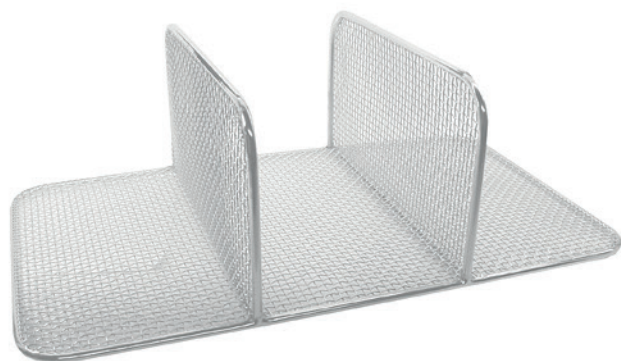

L(mm) B(mm) H(mm)

405 250 130 **SK 205/72**

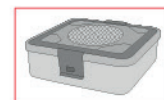

KYE

SK

KYE

SK

KYE

SK

SU



**Lochblechsiebkorb**  
**Perforated steel basket**  
**Cestilla de acero perforado**  
**Panier d'acier poinçonné**  
**Cestello d'acciaio perforato**



L(mm) B(mm) H(mm)

410 250 50 **SK 210/05**  
 410 250 60 **SK 210/06**  
 410 250 70 **SK 210/07**  
 410 250 100 **SK 210/10**



**Siebdeckel**  
**Top for basket**  
**Tapa para cestilla**  
**Couvercle pour panier**  
**Coperchio per cestello**



L(mm) B(mm)

410 250 **SK 210/50**

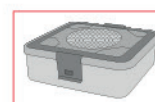

**1/1**  
Container

Deckel gelocht, allein  
Lid perforated, only  
Tapa perforada, suelta  
Couvercle poinçonné, seul  
Coperchio perforato, solo



**L(mm)**   **B(mm)**  
580   280



**KYE 280/51**



**KYE 280/52**



**KYE 280/53**



**KYE 280/54**



**KYE 280/55**

Sicherheitsdeckel alleine, nur zur Verwendung mit Deckel gelocht  
Safety lid only, only for use with lid perforated  
Tapa de seguridad suelta, sólo para uso con tapa perforada  
Couvercle de sécurité seul, utilisation uniquement avec couvercle poinçonné  
Coperchio di sicurezza solo, solo per uso con coperchio perforato



**L(mm)**   **B(mm)**  
580   280



**KYE 281/51**



**KYE 281/52**



**KYE 281/53**



**KYE 281/54**



**KYE 281/55**

Deckel nicht gelocht, allein  
Lid not perforated, only  
Tapa no perforada, suelta  
Couvercle non poinçonné, seul  
Coperchio non perforato, solo



**L(mm)**   **B(mm)**  
580   280



**KYE 289/51**



**KYE 289/52**



**KYE 289/53**



**KYE 289/54**



**KYE 289/55**



Bestellinformation: Wanne + Deckel  
 Order information: Bottom + Lid  
 Información de pedido: Fondo + Tapa  
 Information de commande: Fond + Couverture  
 Informazione dell'ordine: Fondo + Coperchio

**1/1**  
**Container**

KYE  
 SK  
 KYE  
 SK  
**KYE**  
 SK  
 SU



Wanne gelocht, allein  
 Bottom perforated, only  
 Fondo perforado, suelto  
 Fond poinçonné, seul  
 Fondo perforato, solo



Wanne nicht gelocht, allein  
 Bottom not perforated, only  
 Fondo no perforado, suelto  
 Fond non poinçonné, seul  
 Fondo non perforato, solo



L(mm)	B(mm)	H(mm)	
580	280	100	<b>KYE 285/10</b>
580	280	135	<b>KYE 285/13</b>
580	280	150	<b>KYE 285/15</b>
580	280	200	<b>KYE 285/20</b>
580	280	260	<b>KYE 285/26</b>

L(mm)	B(mm)	H(mm)	
580	280	100	<b>KYE 287/10</b>
580	280	135	<b>KYE 287/13</b>
580	280	150	<b>KYE 287/15</b>
580	280	200	<b>KYE 287/20</b>
580	280	260	<b>KYE 287/26</b>

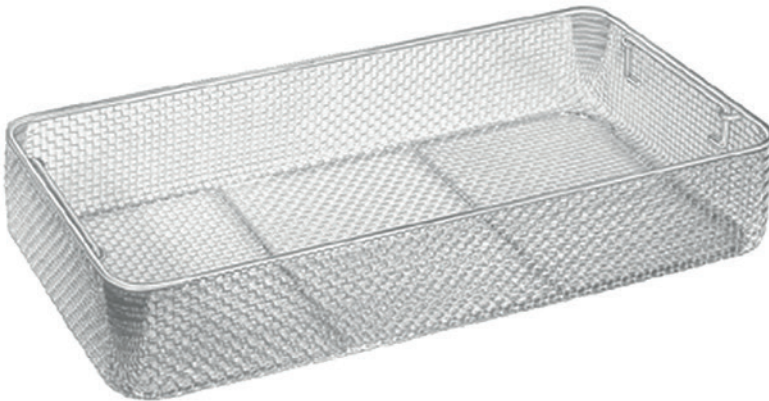

L(mm)	B(mm)	H(mm)	
485	255	30	<b>SK 305/03</b>
485	255	50	<b>SK 305/05</b>
485	255	60	<b>SK 305/06</b>
485	255	70	<b>SK 305/07</b>
485	255	100	<b>SK 305/10</b>
540	255	30	<b>SK 307/03</b>
540	255	50	<b>SK 307/05</b>
540	255	60	<b>SK 307/06</b>
540	255	70	<b>SK 307/07</b>
540	255	100	<b>SK 307/10</b>

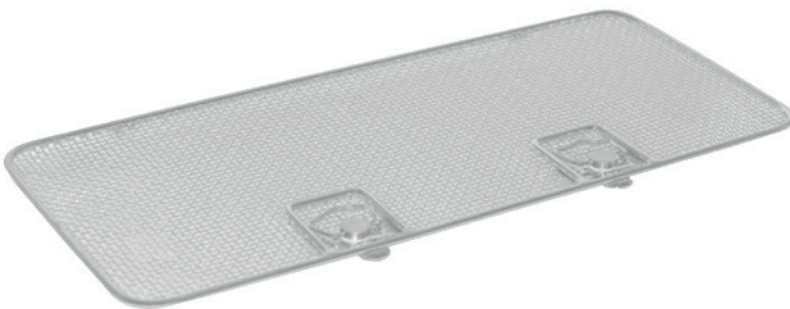

L(mm)	B(mm)	
485	255	<b>SK 305/50</b>
540	255	<b>SK 307/50</b>

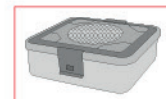



KYE

SK

KYE

SK

KYE

SK

SU



L(mm)	B(mm)
545	255

**SK 307/61**

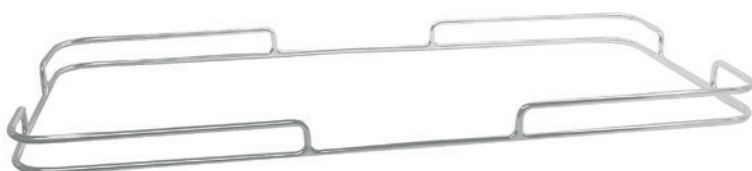
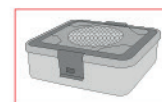

L(mm)	B(mm)	H(mm)
545	255	30

**SK 307/62**

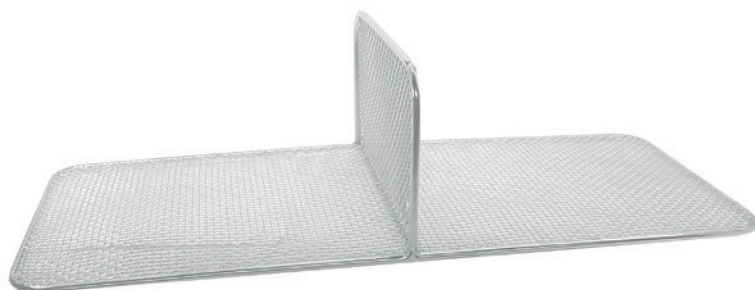
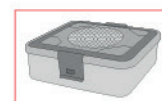

L(mm)	B(mm)	H(mm)
510	250	130
510	250	180
510	250	230

**SK 307/71**

**SK 307/75**

**SK 307/76**

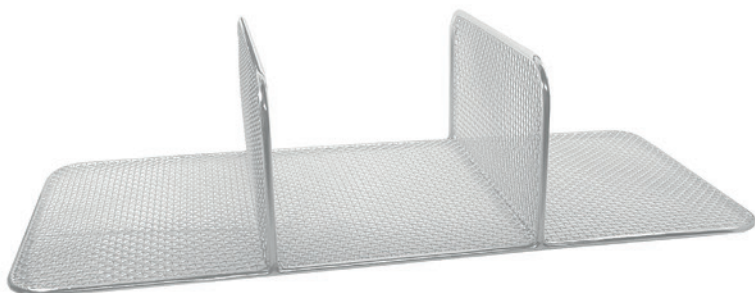

L(mm)	B(mm)	H(mm)
510	250	130
510	250	180
510	230	230

**SK 307/72**

**SK 307/78**

**SK 307/79**

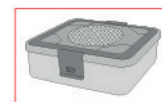

Lochblechsiebkorb  
 Perforated steel basket  
 Cestilla de acero perforado  
 Panier d'acier poinçonné  
 Cestello d'acciaio perforato



L(mm)	B(mm)	H(mm)	
480	250	50	<b>SK 310/05</b>
480	250	60	<b>SK 310/06</b>
480	250	70	<b>SK 310/07</b>
480	250	100	<b>SK 310/10</b>
540	250	50	<b>SK 311/05</b>
540	250	60	<b>SK 311/06</b>
540	250	70	<b>SK 311/07</b>
540	250	100	<b>SK 311/10</b>



Siebdeckel  
 Top for basket  
 Tapa para cestilla  
 Couvercle pour panier  
 Coperchio per cestello



L(mm)	B(mm)	
480	250	<b>SK 310/50</b>
540	250	<b>SK 311/50</b>

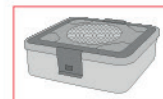

VERSCHIEDENES  
VARIOUS ITEMS  
ARTICULOS DIVERSOS  
ARTICLES DIVERS  
ARTICOLI DIVERSI

SU

nopa<sup>®</sup> instruments

Unser komplettes Programm Verschiedenes finden Sie in unserem Katalog „Container System“.

For our complete range of Various items kindly refer to our catalogue „Container system“.

Para nuestro gama completa de Artículos Diversos, por favor consulte nuestro catálogo de „Sistema de contenedor“.

Pour notre gamme complet des Articles Divers, consultez notre catalogue „Système de conteneur“.

Per nostro assortimento completo di Articoli Diversi, consultare il nostro catalogo „Sistema del Contenitore“.





Ø(mm)

- 40 **SU 105/40**
- 45 **SU 105/45**
- 55 **SU 105/55**
- 75 **SU 105/75**



Ø(mm)

- 40 **SU 106/40**
- 45 **SU 106/45**
- 55 **SU 106/55**
- 75 **SU 106/75**



L(mm)    Ø(mm)

- 240    60    **SU 108/24**

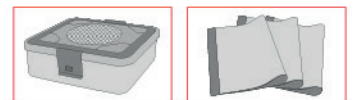

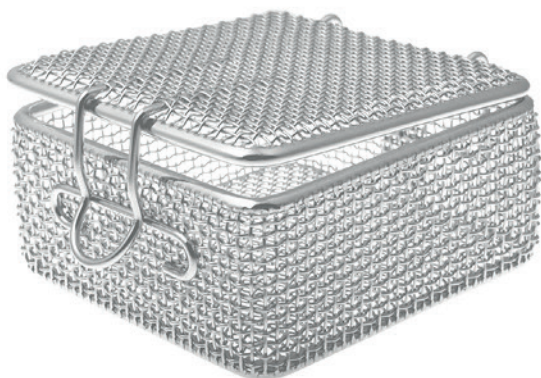

L(mm)	B(mm)	H(mm)	
30	30	30	<b>SU 121/02</b>
30	40	20	<b>SU 121/04</b>
40	40	20	<b>SU 121/06</b>
40	40	40	<b>SU 121/08</b>
60	60	20	<b>SU 121/10</b>
60	60	40	<b>SU 121/12</b>
60	60	60	<b>SU 121/14</b>
80	40	20	<b>SU 121/16</b>
80	40	30	<b>SU 121/18</b>
80	40	40	<b>SU 121/20</b>
80	80	20	<b>SU 121/22</b>
80	80	40	<b>SU 121/24</b>
80	80	60	<b>SU 121/26</b>
80	80	80	<b>SU 121/28</b>
100	100	10	<b>SU 121/30</b>
105	70	25	<b>SU 121/32</b>
120	120	30	<b>SU 121/34</b>
120	120	60	<b>SU 121/36</b>
150	50	35	<b>SU 121/38</b>
190	85	100	<b>SU 121/40</b>
200	100	35	<b>SU 121/42</b>
220	140	50	<b>SU 121/44</b>
235	80	30	<b>SU 121/46</b>
235	155	40	<b>SU 121/48</b>
240	30	40	<b>SU 121/50</b>
240	120	35	<b>SU 121/52</b>
240	240	60	<b>SU 121/54</b>
240	240	80	<b>SU 121/56</b>
275	175	35	<b>SU 121/58</b>
275	200	35	<b>SU 121/60</b>







**L(mm) B(mm) H(mm)**

120	250	30	<b>SU 150/03</b>
120	250	50	<b>SU 150/05</b>
120	250	60	<b>SU 150/06</b>
120	250	70	<b>SU 150/07</b>
120	250	100	<b>SU 150/10</b>

240	250	30	<b>SU 151/03</b>
240	250	50	<b>SU 151/05</b>
240	250	60	<b>SU 151/06</b>
240	250	70	<b>SU 151/07</b>
240	250	100	<b>SU 151/10</b>

255	245	30	<b>SU 152/03</b>
255	245	50	<b>SU 152/05</b>
255	245	60	<b>SU 152/06</b>
255	245	70	<b>SU 152/07</b>
255	245	100	<b>SU 152/10</b>

405	250	30	<b>SU 153/03</b>
405	250	50	<b>SU 153/05</b>
405	250	60	<b>SU 153/06</b>
405	250	70	<b>SU 153/07</b>
405	250	100	<b>SU 153/10</b>

405	255	30	<b>SU 154/03</b>
405	255	50	<b>SU 154/05</b>
405	255	60	<b>SU 154/06</b>
405	255	70	<b>SU 154/07</b>
405	255	100	<b>SU 154/10</b>

480	250	30	<b>SU 155/03</b>
480	250	50	<b>SU 155/05</b>
480	250	60	<b>SU 155/06</b>
480	250	70	<b>SU 155/07</b>
480	250	100	<b>SU 155/10</b>

485	255	30	<b>SU 156/03</b>
485	255	50	<b>SU 156/05</b>
485	255	60	<b>SU 156/06</b>
485	255	70	<b>SU 156/07</b>
485	255	100	<b>SU 156/10</b>

**L(mm) B(mm) H(mm)**

480	360	30	<b>SU 157/03</b>
480	360	50	<b>SU 157/05</b>
480	360	60	<b>SU 157/06</b>
480	360	70	<b>SU 157/07</b>
480	360	100	<b>SU 157/10</b>

480	480	30	<b>SU 158/03</b>
480	480	50	<b>SU 158/05</b>
480	480	60	<b>SU 158/06</b>
480	480	70	<b>SU 158/07</b>
480	480	100	<b>SU 158/10</b>

515	245	30	<b>SU 159/03</b>
515	245	50	<b>SU 159/05</b>
515	245	60	<b>SU 159/06</b>
515	245	70	<b>SU 159/07</b>
515	245	100	<b>SU 159/10</b>

540	250	30	<b>SU 160/03</b>
540	250	50	<b>SU 160/05</b>
540	250	60	<b>SU 160/06</b>
540	250	70	<b>SU 160/07</b>
540	250	100	<b>SU 160/10</b>



**L(mm) B(mm)**

120	250	<b>SU 150/20</b>
240	250	<b>SU 151/20</b>
255	245	<b>SU 152/20</b>
405	250	<b>SU 153/20</b>
405	255	<b>SU 154/20</b>
480	250	<b>SU 155/20</b>
485	255	<b>SU 156/20</b>
480	360	<b>SU 157/20</b>
480	480	<b>SU 158/20</b>
515	245	<b>SU 159/20</b>
540	250	<b>SU 160/20</b>





KYE

SK

KYE

SK

KYE

SK

SU



SU 509/25



SU 509/45



Nur Deckel farbig  
Lid colored only  
Solamente tapa en diferentes colores  
Seulement de couvercle de couleurs différentes  
Solo coperchio colorato

L(mm)	B(mm)	H(mm)			
250	60	50	SU 509/25	SU 509/26	SU 509/27
450	70	70	SU 509/45	SU 509/46	SU 509/47

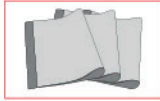

Nur Deckel farbig  
Lid colored only  
Solamente tapa en diferentes colores  
Seulement de couvercle de couleurs différentes  
Solo coperchio colorato

L(mm)	B(mm)	H(mm)			
250	60	50	<b>SU 512/25</b>	<b>SU 512/26</b>	<b>SU 512/27</b>
450	70	70	<b>SU 512/45</b>	<b>SU 512/46</b>	<b>SU 512/47</b>



KYE

SK

KYE

SK

KYE

SK



L(mm)	B(mm)	H(mm)	für 1 Endoskop for 1 Telescope	für 2 Endoskope for 2 Telescopes
180	80	52	<b>SU 515/18</b>	
290	80	52	<b>SU 515/29</b>	<b>SU 516/29</b>
460	80	52	<b>SU 515/46</b>	<b>SU 516/46</b>
600	80	52	<b>SU 515/60</b>	
640	150	77	<b>SU 515/64</b>	
670	80	52	<b>SU 515/67</b>	
700	80	52	<b>SU 515/70</b>	

SU



Mit Silikonfixierungen  
with silicon fixations





L(mm)	B(mm)	H(mm)	
290	160	52	<b>SU 520/05</b>
310	150	77	<b>SU 520/10</b>
460	160	52	<b>SU 520/20</b>
460	225	52	<b>SU 520/30</b>
580	160	52	<b>SU 520/40</b>

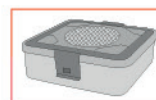



ENDOSKOPIE  
ENDOSCOPY  
ENDOSCOPIA  
ENDOSCOPIE  
ENDOSCOPIA

X

nopa<sup>®</sup> instruments

Weitere Endoskopie-Instrumente finden Sie in unserem Katalog „Endoskopie“.

For further endoscopic instruments kindly refer to our catalogue „Endoscopy“.

Para instrumental de endoscopía adicional, por favor consulte nuestro catálogo de „Endoscopía“.

Pour des instruments d'endoscopie supplémentaires, consultez notre catalogue „Endoscopie“.

Per gli altri strumenti endoscopia, consultare il nostro catalogo „Endoscopia“.





>> Trokarhülsen und Trokare >> Trocar Sleeves and Trocars >> Camisa para trocares y trocares >> Trocards à manche et trocards >> Manicotti trequarti e trequarti	393	<b>XK</b>
>> Easy Clean	394-399	<b>XM</b>
>> Sinuskopie, Otoskopie >> Sinuscopy, otoscopy >> Senoscopia, otoscopia >> Sinuscopie, otoscopie >> Sinuscopia, otoscopia	400-402	<b>XP</b>
>> Flexibles Nasopharyngoskop >> Flexible Nasopharyngoscope >> Nasopharyngoscopio flexible >> Nasopharyngoscope flexible >> Nasopharyngoscopio flessibile	403	<b>XQ</b>
>> HF-Instrumente und Zubehör >> HF-Instruments and accessories >> AF-instrumentos y accesorios >> HF-instruments et accessoires >> AF-strumenti ed accessori	404-411	<b>XR</b>
>> Kaltlichtkabel, Zoom Adapter >> Fibre optic cable, Zoom Adapter >> Cable fibra óptica, Zoom Adaptador >> Câble fibre optique, Zoom Connexion >> Cavo fibra ottica, Zoom Adattatore	412-414	<b>XT</b>

Wundhaken mit Kaltlichtbeleuchtung  
 Retractor with fibreoptic illumination  
 Retractor con iluminación de fibra óptica  
 Rétracteur avec illumination par fibre optique  
 Divaricatore con illuminazione a fibre ottiche



**FERREIRA**  
**AK 451/10**  
 10 cm/4"

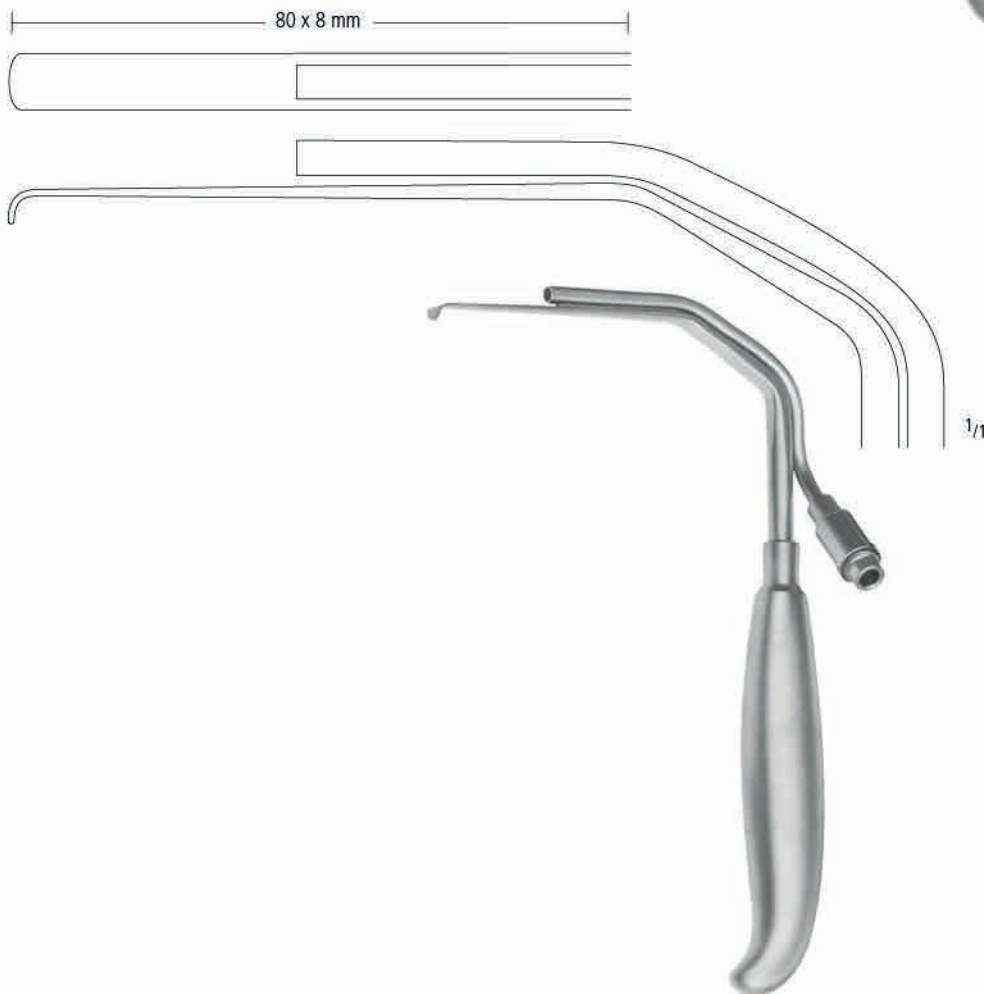

**AK 452/15**

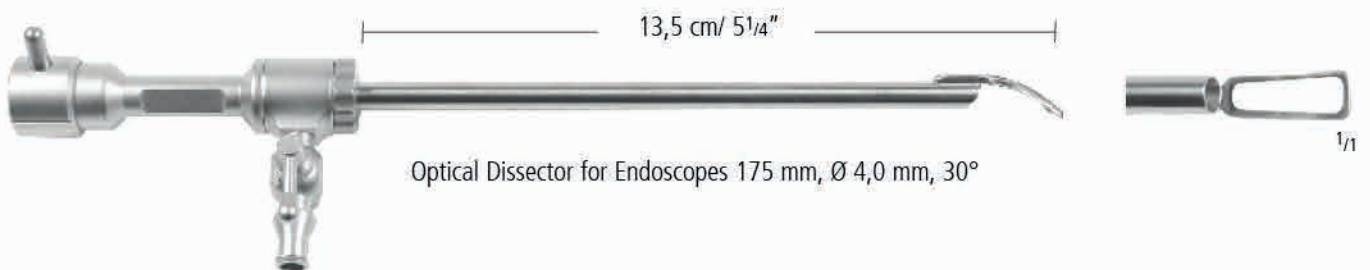

Optical Dissector for Endoscopes 175 mm, Ø 4,0 mm, 30°

**AK 456/01**

ENDOSKOPIE ENDOSCOPY ENDOSCOPIA ENDOSCOPIE ENDOSCOPIA

Trokarhülsen und Trokare  
Trocar Sleeves and Trocars  
Camisa para trocares y trocares  
Trocards à manche et trocards  
Manicotti tre quarti e tre quarti

XK

XM

XP

XQ

XR

XT



Ⓐ + Ⓑ Universal sheaths with rotating stopcocks

UNIVERSAL SHEATHS L = 175 mm

	Ø mm	A	B
STANDARD	2,7	XK 709/01	XK 709/02
	4,0	XK 709/11	XK 709/12
SMALL JOINT	2,7	XK 709/31	XK 709/32



TROCARS AND OBTURATOR

	Ø mm	∧	∩
STANDARD	2,7	XK 710/01	XK 710/02
	4,0	XK 710/11	XK 710/12
SMALL JOINT	2,7	XK 710/31	XK 710/32



# easyClean<sup>®</sup>



**XM 010/00**



**XM 014/00**



Ø 5,0 mm      L      18,0 cm/7"      **XM 020/18**

höchste Präzision und Qualität >> maximum precision and quality standards



Bestellinformation: Bestellen Sie bitte Griff, Schaft und Arbeitseinsatz.  
 Ordering information: Please order handle, tube and working tip.

easyClean<sup>®</sup>

XX

**XM**

XP

XQ

XR

XT



**XM 016/00**



Ø 5,0 mm      L      18,0 cm/7"      **XM 020/18**

höchste Präzision und Qualität >> maximum precision and quality standards







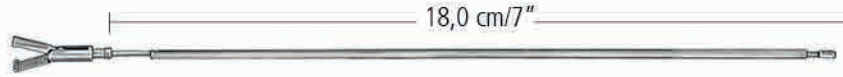

Bestellinformation: Bestellen Sie bitte Griff, Schaft und Arbeitseinsatz.  
Ordering information: Please order handle, tube and working tip.

Biopsie, scharfe Präparation  
 Biopsy, sharp dissection  
 Biopsía, disección en punta  
 Biopsie, dissection tranchant  
 Biopsia, dissezione tagliente

# easyClean<sup>®</sup>



	1/1	Ø 5,0 mm	18,0 cm/7"	<b>XM 104/18</b>
STANZE PUNCH				
	1/1	Ø 5,0 mm		<b>XM 108/18</b>
HAKENSTANZE HOOK PUNCH				
	1/1	Ø 5,0 mm		<b>XM 130/18</b>
MICROSCHERE MICRO SCISSORS				
	1/1	Ø 5,0 mm		<b>XM 131/18</b>
MICROSCHERE GEBOGEN MICRO SCISSORS CURVED				
	1/1	Ø 5,0 mm		<b>XM 134/18</b>
HAKENSCHERE HOOK SCISSORS				
	1/1	Ø 5,0 mm		<b>XM 138/18</b>
METZENBAUM SCHERE METZENBAUM SCISSORS				
	1/1	Ø 5,0 mm		<b>XM 139/18</b>
METZENBAUM SCHERE GEBOGEN METZENBAUM SCISSORS CURVED				

Stumpfe Präparation, Fasszangen  
Blunt Dissection, grasping forceps  
Dissección roma, pinzas de aprehensión  
Dissection émoussée, pinces à préhension  
Dissezione smusse, pinze da presa

easyClean<sup>®</sup>



1/1 Ø 5,0 mm

**XM 160/18**



1/1 Ø 5,0 mm

**XM 168/18**



1/1 Ø 5,0 mm

**XM 170/18**



1/1 Ø 5,0 mm

**XM 172/18**



1/1 Ø 5,0 mm

**XM 202/18**



1/1 Ø 5,0 mm

**XM 208/18**

XX

XM

XP

XQ

XR

XT

Fasszangen  
Grasping Forceps  
Pinzas de aprehensión  
Pinces à préhension  
Pinze da presa

# easyClean®



1/1

Ø 5,0 mm

18,0 cm/7"

**XM 212/18**

SCHARFER ATRAUMATISCHER GREIFER  
SHARP ATRAUMATIC GRASPER



1/1

Ø 5,0 mm

**XM 214/18**

GEZAHNTER GREIFER KOBRA  
TOOTHED GRASPER COBRA



1/1

Ø 5,0 mm

**XM 216/18**

ALLIGATOR GREIFZANGE  
ALLIGATOR GRASPING FORCEPS



1/1

Ø 5,0 mm

5,0 x 30,0 mm  
5,0 x 40,0 mm  
5,0 x 50,0 mm

**XM 220/18**  
**XM 221/18**  
**XM 222/18**

**DE BAKEY**



1/1

Ø 5,0 mm

2,5 x 30,0 mm  
2,5 x 40,0 mm  
2,5 x 50,0 mm

**XM 228/18**  
**XM 229/18**  
**XM 230/18**

**GLASSMAN**



1/1

Ø 5,0 mm

**XM 236/18**

**ALLIS**



Fasszangen  
Grasping Forceps  
Pinzas de aprehensión  
Pincas à préhension  
Pinze da presa

# easyClean<sup>®</sup>



1/1 Ø 5,0 mm

18,0 cm/7"

**XM 245/18**



1/1 Ø 5,0 mm

**XM 254/18**



1/1 Ø 5,0 mm

**XM 258/18**



1/1 Ø 5,0 mm

**XM 260/18**

XX

XM

XP

XQ

XR

XT

Scharfe Präparation, Faszangen  
 Sharp dissection, Grasping Forceps  
 Disección en punta, Pinzas de aprehensión  
 Dissection tranchant, Pincas à préhension  
 Dissezione tagliente, Pinze da presa



**XM 295/18**

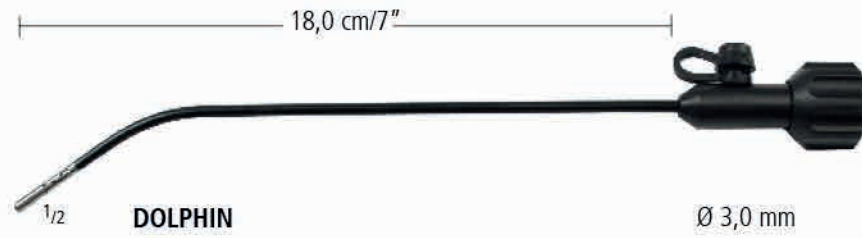

**XM 296/18**



>> autoklavierbar  
autoclavable

>> mit Anschluss für  
with adaptors for

Storz  
Wolf  
ACMI

1/1

	STANDARD 90°			
Ø mm	$\alpha = 0^\circ$	$\alpha = 30^\circ$	$\alpha = 70^\circ$	
2,7	XP 700/30	XP 700/33	XP 700/37	



>> autoklavierbar  
autoclavable

>> mit Anschluss für  
with adaptors for

Storz  
Wolf  
ACMI

1/1

Arthroscope	Ø mm	$\alpha = 0^\circ$	$\alpha = 30^\circ$	$\alpha = 45^\circ$	$\alpha = 70^\circ$	Wide angle
	4,0	XP 701/40	XP 701/43	XP 701/45	XP 701/47	



>> autoklavierbar  
autoclavable

>> mit Anschluss für  
with adaptors for

Storz  
Wolf  
ACMI

1/1

Ø mm	$\alpha = 0^\circ$	$\alpha = 30^\circ$	$\alpha = 70^\circ$	Wide angle
4,0	XP 703/40	XP 703/43	XP 703/47	

Otoskopie  
Otoscopy  
Otoscofia  
Otoscopie  
Otoscofia



>> autoklavierbar  
autoclavable

>> mit Anschluss für  
with adaptors for

Storz  
Wolf  
ACMI

	STANDARD 90°		
Ø mm	$\alpha = 0^\circ$	$\alpha = 30^\circ$	$\alpha = 70^\circ$
2,7	<b>XP 704/30</b>	<b>XP 704/33</b>	<b>XP 704/37</b>

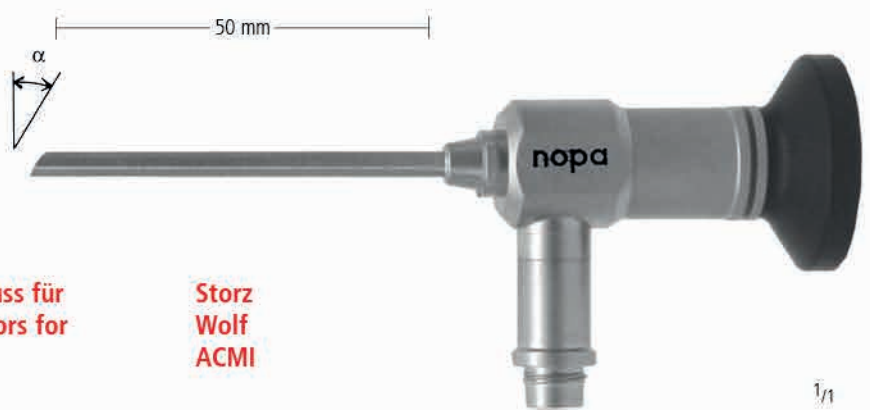

>> autoklavierbar  
autoclavable

>> mit Anschluss für  
with adaptors for

Storz  
Wolf  
ACMI

	STANDARD 90°	
Ø mm	$\alpha = 0^\circ$	$\alpha = 30^\circ$
4,0	<b>XP 718/40</b>	<b>XP 718/43</b>

Flexibles Nasopharyngoskop  
Flexible Nasopharyngoscope  
Nasopharyngoscopio flexible  
Nasopharyngoscope flexible  
Nasopharyngoscopio flessibile

XK

XM

XP

XQ

XR

XT

## flexible nasopharyngoscope

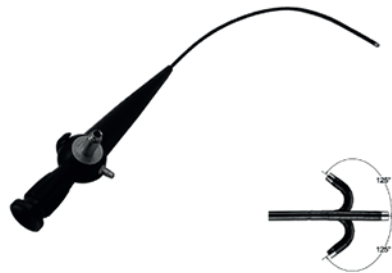

XQ 510/30

Das nopa Nasopharyngoskop wird komplett mit Aufbewahrungskoffer und Drucktester geliefert.  
The nopa nasopharyngoscope will be delivered in a case and with a pressure testing device.

### Flexibles Nasopharyngoskop

#### Beschreibung XQ 510/30

Diese neue Generation des flexiblen Nasopharyngoskops von nopa wurde unter Berücksichtigung der neuesten Produktionsmethoden und Technologien in enger Zusammenarbeit mit klinischen Anwendern entwickelt.

Die innovativen Besonderheiten und die herausragende optische Qualität garantieren dem Benutzer ein optimales Bild.

Die neue Generation der Bildübertragungs-Technik liefert brillante Detailaufnahmen sowohl in den Ecken eines Bildes als auch in der Bildmitte. Das Erkennen kleinster Strukturen wird dadurch erheblich erleichtert. Die Wiedergabe der natürlichen Farben ermöglicht dem Benutzer eine bessere Diagnostik.

Das nopa Nasopharyngoskop bietet ein Höchstmaß an Hygiene.

#### Technische Daten

##### XQ 510/30

nopa Nasopharyngoskop

Bildwinkel:	85°
Tiefenschärfe:	2,5 - 5,0 mm
Außendurchmesser:	3,6 mm
Außendurchmesser distales Ende:	3,6 mm
Nutzlänge:	300 mm

Schwenkbereich des distalen Endes

Aufwärts:	125°
Abwärts:	125°

Technische Änderungen zur Produktverbesserung vorbehalten.

### flexible nasopharyngoscope

#### Description XQ 510/30

This new generation of the flexible nasopharyngoscope from nopa has been newly developed in close cooperation with clinical users, with an eye to production methods and technologies.

The innovative features and the outstanding optical quality provide the best image for the user.

The new generation of image transmission technology provides brilliant detail definition at the edges of the images as well as in the centre. Recognition of even the smallest structures is thereby greatly facilitated. The natural colour rendition assists the user with better diagnostic.

The new generation is also designed for optimum hygiene.

#### Technical data

##### XQ 510/30

nopa nasopharyngoscope

Field of view:	85°
Depth of field:	2,5 - 5,0 mm
Outer diameter insertion tube:	3,6 mm
Outer diameter distal end:	3,6 mm
Working length:	300 mm

Bending range of distal tip

Upward:	125°
Down:	125°

Specification subject to change without notice.



Elektrodenhandgriffe  
Electrode handles  
Mangos porta-electrodos  
Manches porte-électrodes  
Mancini porta elettrodi



**ERBE**  
**XR 800/01**



**MARTIN/BERCHTOLD**  
**XR 800/05**



**MARTIN/BERCHTOLD**  
**XR 801/05**

ENDOSKOPIE ENDOSCOPY ENDOSCOPIA ENDOSCOPIE ENDOSCOPIA

Elektrodenhandgriffe mit Kabel  
 Electrode handles with cable  
 Mangos porta-electrodos con cable fijo  
 Manches porte-électrodes avec câble  
 Mancini porta elettrodi con cavo

XX

XM

XP

XQ

**XR**

XT



**MARTIN/BERCHTOLD**  
**XR 803/05**

**ERBE (U.S.)**  
**XR 804/01**

**VALLEYLAB**  
**XR 805/09**

**VALLEYLAB**  
**XR 806/09**

Anschlusskabel  
 Connection cords  
 Cables de conexión  
 Câbles de raccordement  
 Cavi da connessione

monopolar

bipolar



MARTIN / BERCHTOLD

300 cm  
 500 cm

**XR 827/03**  
**XR 827/05**

**XR 828/03**  
**XR 828/05**

**XR 830/03**  
**XR 830/05**

monopolar

bipolar

monopolar

bipolar



300 cm  
 500 cm

**ERBE**  
**XR 831/03**  
**XR 831/05**  
 (ACC/ICC)

**ERBE**  
**XR 831/13**  
 (T-Serie)

**ERBE/SELECT**  
**XR 832/03**  
**XR 832/05**

**ERBE**  
**XR 833/03**  
**XR 833/05**

**VALLEYLAB**  
**XR 834/03**  
**XR 834/05**  
 (in D nicht zulässig  
 nach MedGV)

Anschlusskabel  
 Connection cords  
 Cables de conexión  
 Câbles de raccordement  
 Cavi da connessione

## für neutralelektroden for patient plates



300 cm  
 500 cm



**XR 835/35**  
**XR 835/55**



300 cm  
 500 cm



**XR 836/31**  
**XR 836/51**

## monopolar



Monopolares Hochfrequenzkabel  
 Monopolar high frequency cord  
 L = 3,0 m **XR 837/03**  
 L = 5,0 m **XR 837/05**



**XR 838/04**  
 10,0 cm/4"  
 4,0 mm

XX  
 XM  
 XP  
 XQ  
**XR**  
 XT

Elektroden  
Electrodes  
Electrodos  
Electrodes  
Elettrodi

## universal



XR 841/01



XR 841/02



XR 841/03



XR 841/04



XR 841/05



XR 841/06



XR 841/07



XR 841/08



XR 841/09



XR 841/10



XR 841/11



XR 841/12



Elektroden  
Electrodes  
Electrodos  
Electrodes  
Elettrodi

XX

XM

XP

XQ

**XR**

XT

# universal



XR 843/01



XR 843/02



XR 843/03



XR 843/04



XR 843/05



XR 843/06



XR 843/07



XR 843/08



XR 843/09

Bi-Koagulations-Pinzetten  
 Bi-Coagulation-Forceps  
 Pinzas para la Bi-Coagulación  
 Pince pour la Bi-Coagulation  
 Pinze per la Bi-Coagulazione



16,0 cm/6 1/4"	<b>XR 890/16A</b>	<b>XR 891/16C</b>	<b>XR 894/16C</b>		
16,0 cm/6 1/4"	<b>XR 890/16C</b>	<b>XR 891/16D</b>	<b>XR 894/16D</b>		
16,0 cm/6 1/4"	<b>XR 890/16E</b>	<b>XR 891/16E</b>			
20,0 cm/8"	<b>XR 890/20A</b>	<b>XR 891/20A</b>	<b>XR 894/20A</b>		
20,0 cm/8"	<b>XR 890/20C</b>	<b>XR 891/20C</b>	<b>XR 894/20C</b>	<b>XR 895/20C</b>	<b>XR 896/20C</b>
20,0 cm/8"	<b>XR 890/20E</b>	<b>XR 891/20F</b>	<b>XR 894/20E</b>		
20,0 cm/8"			<b>XR 894/20F</b>		
22,0 cm/8 3/4"	<b>XR 890/22A</b>	<b>XR 891/22C</b>	<b>XR 894/22D</b>		
22,0 cm/8 3/4"	<b>XR 890/22C</b>		<b>XR 894/22E</b>		<b>XR 896/22C</b>

A=2,0 mm

C=1,0 mm



D=0,5 mm

E=Nadel

F=Profil



11,0 cm/4 1/3"	<b>XR 898/11D</b>	<b>XR 899/11D</b>
11,0 cm/4 1/3"	<b>XR 898/11E</b>	<b>XR 899/11E</b>

Kaltlichtkabel  
Fibre optic cable  
Cable fibra óptica  
Câble fibre optique  
Cavo fibra ottica

XX

XM

XP

XQ

XR

**XT**



- XT 035/18** Ø 3,5 mm, 180 cm
- XT 035/23** Ø 3,5 mm, 230 cm
- XT 035/30** Ø 3,5 mm, 300 cm
  
- XT 045/18** Ø 4,5 mm, 180 cm
- XT 045/23** Ø 4,5 mm, 230 cm
- XT 045/30** Ø 4,5 mm, 300 cm
  
- XT 060/23** Ø 6,0 mm, 230 cm

**Kaltlicht-Grundkabel**  
**Basic fibre optic cable**



- XT 070/18** Ø 4,5 mm, 180 cm
- XT 070/23** Ø 4,5 mm, 230 cm
- XT 070/30** Ø 4,5 mm, 300 cm

- >> **Zusätzliche Isolierung**
- >> **Metallspirale**
- >> **Silikonmantel**
- >> **Sterilisierbar**

- >> **Additionally insulated**
- >> **Metal spiral**
- >> **Silicon tube**
- >> **Autoclavable**

Adapter  
Adapter  
Adaptador  
Connexion  
Adattatore

**Projektor-Seite**  
**Projector side**

**Endoskop-Seite**  
**Endoscope side**

**XT 100/01**



**STORZ**



**XT 100/11**

**STORZ/WINTER + IBE**  
**OLYMPUS/STRYKER**

**XT 100/02**



**WOLF/HENKE-SASS**



**XT 100/12**

**WOLF/HENKE-SASS**

**XT 100/03**



**ACM/HEINE**



**XT 100/13**

**ACM/HEINE**

**XT 100/04**



**WINTER + IBE**

**XT 100/05**



**OLYMPUS**

**Bestellinformation / Ordering information**

**>> Bitte bestellen Sie Kaltlicht-  
grundkabel mit 2 Adaptern**

**>> Please order the basic fibre  
optic cable and two adapters**

Zoom - Adapter  
 Zoom - Adapter  
 Zoom - Adaptador  
 Zoom - Connexion  
 Zoom - Adattatore

XX

XM

XP

XQ

XR

XT



**XT 361/40**

Zoom - Objektiv	15 mm - 25 mm
zoom - objective	15 mm - 25 mm



**XT 361/50**

Zoom - Objektiv	25 mm - 40 mm
Zoom - objective	25 mm - 40 mm





# Inhaltsverzeichnis

	Seite		Seite
<b>A</b>		<b>BARTH</b> , Ohrlöffel	289
<b>ABRAHAM</b> , Tonsillennmesser	247	<b>BAUMGARTNER</b> , Nadelhalter	105
<b>ACM/HEINE</b> , Adapter	412	<b>BEALES</b> , Elevatorien	299
Adenotome	354	<b>BECKMANN(NEGUS)</b> , Ringmesser	353
<b>ADLERKREUTZ</b> , Pinzetten	42	<b>BECKMANN</b> , Nasenspekula	311
<b>ADSON</b> , Hartmetallpinzetten <b>TUC</b>	57	<b>BECKMANN</b> , Ringmesser	353
<b>ADSON</b> , Nadelhalter	105	<b>BEER</b> , Cilienpinzetten	51
<b>ADSON</b> , Pinzetten	36, 37	<b>BELLUCCI</b> , Mikro Ohrzängchen	287
<b>ADSON</b> , Saugrohre	160	<b>BERCHTOLD/MARTIN</b> , Anschlusskabel	406
<b>ADSON-BABY</b> , selbsthaltender Wundsperrerr	152	<b>BERCHTOLD/MARTIN</b> , Elektrohandgriffe	404
<b>ADSON-BROWN</b> , Pinzetten	37	<b>BERCHTOLD/MARTIN</b> , Elektrohandgriffe mit Kabel	405
<b>ADSON-MICRO</b> , Pinzetten	36	<b>BERNHARD</b> , Tuchklemmen	30
<b>ADSON-TOENNIS-DELICATE</b> , Hartmetallscheren <b>TUC</b>	93	Besteck, Diagnostik-	192, 193
<b>ADVENTITIA</b> , Mikroscheren	80, 82	<b>BEYER</b> , Hohlmeißelzangen	225
<b>ALDERDYCE</b> , Elevatorien	217	<b>BEYER</b> , Stanzen	288
<b>ALEXANDER</b> , Meißel	198	Bi-Koagulations-Pinzetten	410
<b>ALLIGATOR</b> , Kehlkopfpolypenzange	273	<b>BILLEAU</b> , Ohrschlingen	290
<b>ALLIS</b> , Fasszange	398	Biopsie	396
<b>ALLIS</b> , Gewebefasszängchen	17	<b>BLOHMKE</b> , Tonsillenzangen	252
<b>ALM</b> , Wundsperrerr	149	<b>BLUMENTHAL</b> , Hohlmeißelzangen	223
<b>ALY</b> , Sensibilitätsinstrument	188	Blutdruckmessapparate	191
<b>ANDERSON-NEIVERT</b> , Osteotome	352	<b>BÖHLER</b> , Hohlmeißelzangen	225
<b>ANDREWS-PYNCHON</b> , Saugrohre	157	<b>BOIES</b> , Instrumente zur Nasenplastik	356
Anlegezangen	19	<b>BOLGER-KUHN</b> , Küretten	347
Anschlusskabel	406, 407	<b>BONACCOLTO</b> , Nahtpinzetten	54
Arbeitseinsätze, easyClean	396-399	<b>BONN MODELL</b> , Nahtpinzetten	54
<b>ARRUGA</b> , Hartmetallnadelhalter <b>TUC</b>	115	<b>BONNEY</b> , Fasspinzetten	44
<b>ARRUGA</b> , Nadelhalter	102	<b>BONNEY</b> , Hartmetallpinzetten <b>TUC</b>	58
Arterienklemmen	21-28	<b>BOSE</b> , Dilatatoren	241
<b>ASCH</b> , Septumrichtzangen	355	<b>BOSE</b> , Tracheal-Häkchen	242
<b>AUFRICHT GLABELLA</b> , Nasenraspeln	340	<b>BÖTTCHER</b> , Tonsillenscheren	72
<b>AUFRICHT(WALTER)</b> , Instrumente zur Nasenplastik	346	<b>BOUCHERON</b> , Ohrspekula	279
<b>AUFRICHT</b> , Instrumente zur Nasenplastik	346	<b>BOWMAN</b> , Speichelgangsonden	274
<b>AUFRICHT</b> , Instrumente zur Nasenplastik mit Kaltlichtbeleuchtung	346	<b>BOYLE-DAVIS</b> , Mundsperrerr	233
<b>AUFRICHT</b> , Nasenraspeln	340	<b>BOYNTON</b> , Hartmetallnadelhalter <b>TUC</b>	115
<b>AUFRICHT</b> , Periost-Elevatorien	336	<b>BOYNTON</b> , Nadelhalter	102
<b>AUSTIN</b> , Mikropinzetten	46	<b>BRODIE</b> , Sonden	154
<b>B</b>		<b>BROPHY</b> , Pinzetten	40
<b>BABCOCK</b> , Darmfasszangen	17	<b>BROPHY-SULLIVAN</b> , feine Scheren	75
<b>BABCOCK</b> , Fasszange	399	<b>BROWN</b> , Pinzetten	41
<b>BABY-ADSON</b> , selbsthaltende Wundsperrerr	152	<b>BROWN-ADSON</b> , Pinzetten	37
<b>BABY-CRILE-WOOD</b> , Hartmetallnadelhalter <b>TUC</b>	111	<b>BRUENINGS</b> , Aufsätze	256, 257
<b>BABY-CRILE-WOOD</b> , Nadelhalter	104	<b>BRUENINGS</b> , Ohrspekula	280
<b>BABY-LEXER</b> , Präparierschere	71	<b>BRUENINGS</b> , Siebbein- und Septumzangen	330
<b>BABY-METZENBAUM</b> , Präparierschere	66	<b>BRUENINGS</b> , Tonsillennmesser	247
<b>BABY-MIXTER</b> , Präparier- und Ligaturklemmen	29	<b>BRUENINGS</b> , Tonsillenschnürer	254
<b>BABY-POOLE</b> , Saugrohre	158	<b>BRUENINGS</b> , Zungendrücker	239
<b>BABY-SENN-MILLER</b> , feine Wundhaken	141	<b>BRUENINGS-BRUNK</b> , Wundhaken	358
<b>BABY-WEITLANER</b> , selbsthaltende Wundsperrerr	150	<b>BRUNS</b> , scharfe Löffel	210, 213
<b>BABY-WEITLANER</b> , Wundsperrerr	150	Bruststütze für Mundsperrerr	236
<b>BACKHAUS</b> , Tuchklemmen	31	<b>BRYANT</b> , Schwammzange	130
<b>BACON</b> , Hohlmeißelzangen	224	<b>BUCK</b> , Ligaturscheren	78
<b>BAINBRIDGE</b> , Arterienklemmen	28	<b>BUCK</b> , Ohrküretten	289
<b>BALL &amp; SOCKET</b> , Tuchklemmen	31	<b>BUCK</b> , Ohrzängchen	283
<b>BALLENGER</b> , Hohlmeißel	348	<b>BUCKINGHAM</b> , Instrumente für die Stapes-Fußplatte	296
<b>BALLENGER</b> , Septum-Elevatorien	336	Bulldogklemmen	18, 19
<b>BALLENGER</b> , Septummesser	336	<b>C</b>	
<b>BALLENGER</b> , Tonsillenzangen	252	<b>CAIRNS</b> , Arterienklemmen	27
<b>BALLENGER-FOERSTER</b> , Schwammzangen	133, 134	<b>CANFIELD</b> , Tonsillennmesser	247
<b>BALLENGER-SLUDER</b> , Tonsillotom	253	<b>CAPLAN</b> , Nasenscheren	73
<b>BARBARA</b> , Ohrnadeln	292, 293	<b>CARDIFF</b> , Nasenspekula	312
<b>BARBON-LUBET</b> , Polypenzangen	315	<b>CARDIOPHON</b> , Stethoskop	190
<b>BARNHILL</b> , Ringmesser	353	<b>CARPENTER</b> , Tonsillennmesser	247
<b>BARON(SCHUKNECHT)</b> , Saugrohre	300	<b>CARREL</b> , Arterienklemme	21
<b>BARSKY</b> , Instrumente zur Nasenplastik	346	<b>CARROLL</b> , Hartmetallnadelhalter <b>TUC</b>	109
		<b>CARROLL</b> , Nadelhalter	104



	Seite		Seite
<b>CARTER</b> , Septum-Elevatorien	336	<b>CRILE-WOOD-BABY</b> , Hartmetallnadelhalter <b>TUC</b>	111
<b>CASTROVIEJO</b> , Hartmetallmikronadelhalter <b>TUC</b>	117	<b>CRILE-WOOD-BABY</b> , Nadelhalter	104
<b>CASTROVIEJO</b> , Klängenbrecher	100	<b>CRURA-NIPPER</b> , Mikro Ohrzängchen	286
<b>CASTROVIEJO</b> , Nahtpinzetten	53	<b>CUSHING</b> , feine Wundhaken	137
<b>CHADWICK</b> , Augenscheren	77	<b>CUSHING</b> , Hartmetallpinzetten <b>TUC</b>	57
<b>CHAPUT</b> , Fasszange	20	<b>CUSHING</b> , Pinzetten	39
<b>CHEATLE</b> , Sterilisierzangen	364	<b>CUSHING-TAYLOR</b> , Hartmetallpinzetten <b>TUC</b>	57
<b>CHEVALIER-JACKSON</b> , Tracheal-Kanülen	244		
<b>CHILDE</b> , Wundklammerpinzetten	127	<b>D</b>	
Chirurgische Scheren	62-65	<b>DAHMEN</b> , Meißel	205
<b>CHRIS-TROUTMAN</b> , Klängenbrecher	100	<b>DAHMEN</b> , Osteotome	205
Cilienpinzetten	51	<b>DANDY</b> , Kopfhautklemmen	28
<b>CINELLI</b> , Flachmeißel	351	Darmfasszangen	17
<b>CITELLI</b> , Stanzen	288	<b>DAVIS-BOYLE</b> , Mundsperrer	233
<b>CLAR</b> 55, Stirnlampen	182	<b>DAVIS-MAYER</b> , Mundsperrer	235
<b>CLAR STANDARD</b> , Stirnlampen	182	<b>DAVIS-RAGNELL</b> , feine Wundhaken	141
<b>CLAUS-HAJEK</b> , Keilbeinstanzen	333	<b>DE BAKEY</b> , Atraumatische Pinzetten	55
<b>CLAUS-KILLIAN</b> , Hohlmeißel	348	<b>DE BAKEY</b> , Fasszange	398
<b>CLEVELAND</b> , Hohlmeißelzangen	222	<b>DE BAKEY</b> , Hartmetallnadelhalter <b>TUC</b>	108
<b>CLEVELAND</b> , Knochensplitterzangen	227	<b>DE BAKEY</b> , Hartmetallpinzetten <b>TUC</b>	58
<b>CLEVELAND-GARDNER</b> , Knochensplitterzangen	226	<b>DE BAKEY</b> , Saugrohre	157
<b>CLOWARD</b> , scharfe Löffel	213	<b>DE LA ROZA</b> , Unterbindungsnadeln	125
<b>COAKLEY</b> , Küretten	347	<b>DEAVER</b> , Scheren	64
<b>COBB</b> , Meißel	204	<b>DENHART</b> , Mundsperrer	231
<b>COLBURN-MILLER</b> , Nasenraspeln	342	<b>DERF</b> , Hartmetallnadelhalter <b>TUC</b>	110
<b>COLLER</b> , Arterienklemmen	24	<b>DERF</b> , Nadelhalter	102
<b>COLLIER</b> , Nadelhalter	102	<b>DERF-CONVERSE</b> , Nadelhalter	102
<b>COLLIN</b> , Hämmer	207	<b>DERLACKI-SHAMBAUGH</b> , Raspatorien	298
<b>COLLIN</b> , Skalpellgriffe	97	Dermatome	99, 100
<b>COLLIN</b> , Wundklammerzängchen	126	<b>DESMARRES</b> , feine Wundhaken	141
<b>COLLIN</b> , Zungenzangen	240	Diagnostik	181-194
<b>COLLIN-DUVAL</b> , Fasspinzette	43	Diagnostikbestecke	192, 193
<b>COLLIN-HARTMANN</b> , Wundhaken	146	<b>DIEFFENBACH</b> , Bulldogklemmen	19
<b>COLVER</b> , Tonsillenzangen	252	<b>DIETER</b> , Mikro Ohrzängchen	287
<b>CONE</b> , Mundsperrer	152	<b>DIETRICH</b> , Hartmetallmikronadelhalter <b>TUC</b>	117
Container 1/1	376-380	Dilatatoren	241
Container 1/2	368-371	<b>DINGMANN</b> , Mundsperrer	233
Container 3/4	371-375	Dissektionmikroschere	80, 82
Container System	365-388	Dissektoren	248-250, 307
Container, Endoskopie	385-387	Dissektoren, Face-Lift	218-221
<b>CONVERSE</b> , feine Wundhaken	345	<b>DIXON-LOVELACE</b> , Arterienklemmen	28
<b>CONVERSE</b> , Flachmeißel	352	<b>DOLPHIN</b> , Stumpfe Präparation	397, 400
<b>CONVERSE</b> , Hartmetallnadelhalter <b>TUC</b>	110	<b>DOUGHTY-KILNER</b> , Mundsperrer	232
<b>CONVERSE</b> , Instrumente zur Nasenplastik	346	<b>DOUGLAS</b> , Cilienpinzetten	51
<b>CONVERSE</b> , Nasenplastik- und Operationsmesser	334	<b>DOUGLAS</b> , Tonsillennmesser	247
<b>CONVERSE-DERF</b> , Nadelhalter	102	<b>DOYEN</b> , Nadelhalter	102
<b>CORDES</b> , Aufsätze	257	<b>DOYEN</b> , Sonden	153
<b>CORWIN</b> , Hartmetalldrahtzangen <b>TUC</b>	116	<b>DOYEN</b> , Tuchklemmen	30
<b>COTTLE KAZANJIAN</b> , Knochensplitterzangen	226	<b>DOYEN</b> , Zungendrucker	239
<b>COTTLE(MILLARD)</b> , feine Wundhaken	345	<b>DRAFFIN</b> , Bruststütze für Mundsperrer	236
<b>COTTLE</b> , Columellaklemme	346	Drahtzangen mit Hartmetalleinsätzen <b>TUC</b>	73
<b>COTTLE</b> , Elevatorien	337	<b>DUCKBILL</b> , Ohrzängchen	284
<b>COTTLE</b> , feine Wundhaken	344, 345	<b>DUEHRSEN</b> , Pinzetten	41
<b>COTTLE</b> , Flachmeißel	349	<b>DUNHILL</b> , Arterienklemmen	27
<b>COTTLE</b> , Hämmer	207, 302, 357	<b>DUPLAY(VOLTOLINI)</b> , Nasenspekula	313
<b>COTTLE</b> , Instrumente zur Nasenplastik	346	<b>DUPLAY</b> , Kornzangen	133
<b>COTTLE</b> , Knorpelquetscher	356	<b>DUPLEX</b> , Stethoskope	190
<b>COTTLE</b> , Nasenpinzetten	52	<b>DUPUY WEISS</b> , Tonsillennadeln	251
<b>COTTLE</b> , Nasenplastik- und Operationsmesser	334	<b>DURANTE</b> , Fasspinzetten	44
<b>COTTLE</b> , Nasenraspeln	340, 343	<b>DUVAL</b> , Fasspinzetten	44
<b>COTTLE</b> , Nasenschere	73	<b>DUVAL-COLLIN</b> , Fasspinzetten	43
<b>COTTLE</b> , Nasenspekula	313		
<b>COTTLE</b> , Osteotome	349	<b>E</b>	
<b>COTTLE-NEIVERT</b> , feine Wundhaken	345	easyClean	394-399
<b>COUPLAND</b> , Saugrohre	158	<b>ECONOM</b> , Diagnostikbestecke	192
<b>CRAIG</b> , Siebbein- und Septumzangen	330	<b>EICKEN-KILLIAN</b> , Saugkanüle	159
<b>CRILE</b> , Arterienklemmen	24	Einführungszängchen für Paukenröhrchen	307
<b>CRILE</b> , Nadelhalter	107	Elektroden	408, 409
<b>CRILE-MURRAY</b> , Nadelhalter	104	Elektrohandgriffe	404
<b>CRILE-RANKIN</b> , Arterienklemmen	24	Elektrohandgriffe mit Kabel	405
<b>CRILE-WOOD</b> , Hartmetallnadelhalter <b>TUC</b>	111		
<b>CRILE-WOOD</b> , Nadelhalter	104		

	Seite		Seite
Elevatorien	216, 217, 298, 299	Gaumensegelhaken	226
Endolaryngeale Mikrochirurgie	259-266	Gefäßdilatatoren	47
Endoskope	401, 402	Gefäßklemmen	20
Endoskopie	399-413	<b>GELFOAM-HOUSE</b> , Quetschzangen	307
<b>ENGLISCHES MODELL</b> , Tuchklemmen	30	<b>GEMINI</b> , Präparier- und Ligaturklemmen	29
Epiglottis Wundhaken	272	<b>GERALD</b> , Pinzetten	39
<b>ERBE</b> (U.S.), Elektrohandgriffe mit Kabel	404	Gewebefasszängchen	17
<b>ERBE</b> , Anschlusskabel	406	<b>GILLIES</b> , feine Wundhaken	135
<b>ERBE</b> , Elektrohandgriffe	404	<b>GILLIES</b> , Hartmetallnadelhalter <b>TUC</b>	113
<b>ERBE/SELECT</b> , Anschlusskabel	405	<b>GILLIES</b> , Hartmetallpinzetten <b>TUC</b>	56
<b>EUFRATE PASQUÉ</b> , Hartmetallnadelhalter <b>TUC</b>	109	<b>GILLIES</b> , Nadelhalter	106
<b>EVES</b> , Tonsillenschnürer	254	<b>GILLIES</b> , Pinzetten	43
<b>EWALD</b> , Pinzetten	37	<b>GLASSMANN</b> , Fasszange	398
<b>F</b>		<b>GOLDMAN-FOX</b> , Hartmetallscheren <b>TUC</b>	93
Face-Lift Dissektoren	218-221	<b>GOLDMANN</b> , Instrumente zur Nasenplastik	356
Facelift-Markierer	188	<b>GOLDSMITH(THUDICHUM)</b> , Nasenspekula	313
Facelift-Scheren	69	<b>GOOD</b> , Tonsillenscheren	72
<b>FARABEUF</b> , Wundhaken	147	<b>GOOD-SCHWECKENDICK</b> , Tonsillenscheren	72
<b>FARRELL</b> , Watteträger	154	<b>GORNEY</b> , Präparierscheren	70
<b>FARRIOR</b> , Ohrspekula	279	<b>GORNEY</b> , Saug-Elevatorien	335
Fasspinzetten	43, 44, 397-400	<b>GORNEY-FREEMAN</b> , Facelift-Scheren	69
<b>FAULKNER</b> , Küretten	347	<b>GRAEFE</b> , feine Wundhaken	136
<b>FEILCHENFELD</b> , Splitterpinzetten	48	<b>GRAZIL</b> , Chirurgische Scheren	63
<b>FEIN</b> , Watteträger	155	<b>GREEN-SENN</b> , feine Wundhaken	140
Feine Wundhaken	135-141	<b>GROSS</b> , Ohrhäkchen	290
<b>FERGUSSON</b> , Saugrohre	159	<b>GROSS-MAIER</b> , Kornzangen	131, 132
<b>FERREIRA</b> , Wundhaken	148	<b>GRUBER</b> , Ohrspekula	278
<b>FERRIS-SMITH</b> , Keilbeinstanzen	333	<b>GRUENWALD (JANSEN)</b> , Nasen-Pinzette	52
<b>FERRIS-SMITH</b> , Pinzetten	42	<b>GUEDEL</b> , Tracheal-Kanülen	244
Fingerschützer	230	<b>GULEN</b> , Spülkanülen	335
<b>FINSEN</b> , Wundsperrer	149	<b>GUTHRIE</b> , feine Wundhaken	139
<b>FISCH</b> , Dissektoren	295	<b>GWYNNE</b> , Dissektoren	250
<b>FISCH</b> , Fußplattenhäkchen	297	<b>H</b>	
<b>FISCHER</b> , Tonsillensmesser	247	Hähne	162
Fixierpinzetten	53	<b>HAJEK</b> , Hämmer	302
Flach- und Hohlmeißel	348	<b>HAJEK-CLAUS</b> , Keilbeinstanzen	333
<b>FLEXIBLES NASOPHARYNGOSKOP</b>	403	<b>HAJEK-KOFFLER</b> , Keilbeinstanzen	332
<b>FOERSTER-BALLENGER</b> , Schwammzangen	133, 134	Häkchen	290
<b>FOMON</b> , feine Wundhaken	344	Haken, Wund-	135-152, 240, 241, 358
<b>FOMON</b> , Flachmeißel	351	<b>HALLE</b> , Elevatorien	337
<b>FOMON</b> , Nasenplastik- und Operationsmesser	334	<b>HALLE</b> , Küretten	348
<b>FOMON</b> , Nasenraspeln	341, 343	<b>HALLE</b> , Nasenscheren	73
<b>FOMON</b> , Nasenscheren	73	<b>HALLE-HARTMANN</b> , Nasenspekula	311
<b>FOMON</b> , Präparierscheren	70	<b>HALLE-RITTER</b> , Stirnhöhlen-Dilatator	335
<b>FOREGGER-WISCONSIN FIBRE OPTIC</b> , Kaltlichtlaryngoskope	168	<b>HALLE-TIECK</b> , Nasenspekula	311
<b>FOREGGER-WISCONSIN</b> , Laryngoskope	164	<b>HALSEY</b> , Hartmetallnadelhalter <b>TUC</b>	110
<b>FOX</b> , scharfe Löffel	212	<b>HALSEY</b> , Nadelhalter	103
<b>FRAENKEL</b> , Aufsätze	257	<b>HALSTED</b> , Arterienklemmen	22
<b>FRAENKEL</b> , Kehlkopfpolypenzangen	272, 273	<b>HALSTED-MOSQUITO</b> , Arterienklemmen	22
<b>FRAZIER</b> , feine Wundhaken	135	Hämmer	207-209, 302, 357
<b>FRAZIER</b> , Saugrohre	159	Handgriffe, easyClean	394, 395
<b>FREEMAN-GORNEY</b> , Facelift-Scheren	69	<b>HARMS</b> , Nahtpinzetten	54
<b>FREER</b> , Elevatorien	217, 337	<b>HARRISON (PYE-SMITH)</b> , Sterilisierzange	364
<b>FREER</b> , feine Wundhaken	344	<b>HARTMANN</b> , Arterienklemmen	21
<b>FREER</b> , Flachmeißel	348	<b>HARTMANN</b> , Hohlmeißelzangen	223
<b>FREER</b> , Hohlmeißel	348	<b>HARTMANN</b> , Nasenspekula	311
<b>FREER</b> , Nasenplastik- und Operationsmesser	338	<b>HARTMANN</b> , Ohrhäkchen	290
<b>FREER</b> , Rhinoplastik-Instrumente	334	<b>HARTMANN</b> , Ohrspekula	278
<b>FREER</b> , Saug-Elevatorien	335	<b>HARTMANN</b> , Ohrzängchen	283, 284
<b>FRENCH-EYE-RYDER</b> , Hartmetallnadelhalter <b>TUC</b>	108	<b>HARTMANN</b> , Polypenzangen	315
<b>FRENCH-HARTMANN</b> , Stimmgabeln	303	<b>HARTMANN</b> , Saugrohre	302
<b>FRENZEL</b> , Zungendrucker	239	<b>HARTMANN</b> , scharfe Nasenzangen	328
<b>FRIEDMAN</b> , Hohlmeißelzangen	222	<b>HARTMANN</b> , scharfe Tonsillenzangen	255
<b>FULLER</b> , Mikro Ohrzängchen	287	<b>HARTMANN</b> , Stimmgabeln	303
<b>G</b>		<b>HARTMANN</b> , Zungendrucker	238
<b>GALLAGHER</b> , Nasenraspeln	340	<b>HARTMANN-COLLIN</b> , Wundhaken	146
<b>GARDNER-CLEVELAND</b> , Knochensplitterzangen	226	<b>HARTMANN-FRENCH</b> , Stimmgabeln	303
Gaumenbogenhalter	226	<b>HARTMANN-HALLE</b> , Nasenspekula	311
		<b>HARTMANN-HOFFMANN</b> , Ohrzängchen	284
		<b>HARTMANN-NOYES</b> , Ohrzängchen	284



<b>HARTMANN-WULLSTEIN</b> , Ohrzängchen	284
<b>HEATH-RICHTER</b> , Wundklammerzängchen	126
<b>HEERMANN</b> , Instrumente für die Stapes-Fußplatte	297
<b>HEGAR-OLSEN</b> , Hartmetallnadelhalter <b>TUC</b>	113
<b>HEGAR-OLSEN</b> , Nadelhalter	106
<b>HEGENBARTH</b> , Wundklammerpinzetten	126
<b>HEISTER</b> , Mundsperrerr	230
<b>HENKE</b> , Dissektoren	248
<b>HENKE-SASS/WOLF</b> , Adapter	412
<b>HENLEY</b> , Wundperrerr	150
<b>HERBERHOLD</b> , Mundsperrerr	235
<b>HESSBERG</b> , Unterbindungsnadeln	125
<b>HEYMANN</b> , Nasenscheren	73
<b>HEYMANN</b> , Siebbein- und Septumzangen	330
<b>HEYMANN-KNIGHT</b> , Polypenzangen	315
<b>HF</b> -Instrumente und Zubehör	407-410
<b>HIBBS SPRATT</b> , scharfe Löffel	213
<b>HIBBS</b> , Meißel	200
<b>HIBBS</b> , Osteotome	200
<b>HILGER</b> , Mundspiegelansätze	269
<b>HOEN</b> , Elevatorien	217
<b>HOFER</b> , Gaumenbogenhalter	251
Hohlmeißel	197-206, 299, 348
Hohlmeißelzangen	222-225
<b>HOKE</b> , Osteotome	197
<b>HOLINGER</b> , Laryngoskope	178
<b>HOPKINS-JOHNS</b> , Anlegezangen	19
<b>HOPKINS-JOHNS</b> , Bulldogklemmen	19
<b>HORNE-JOBSON</b> , Watteträger	155
<b>HOSPITAL-PROVIDENCE</b> , Arterienklemmen	23
<b>HOUSE</b> , Instrumente für die Stapes-Fußplatte	296
<b>HOUSE</b> , Mikroinstrumente	295
<b>HOUSE</b> , Saugrohre	300
<b>HOUSE-GELFOAM</b> , Quetschzangen	307
<b>HOWARTH</b> , Elevatorien	338
<b>HUBER</b> , Universalgriff	256
<b>HUMBY</b> , Dermatome	99
<b>HUMBY</b> , Instrumente zur Nasenplastik	346
<b>HUNTER</b> , Fasszange	399
<b>HUNTER</b> , Splitterpinzetten	48
<b>HUPP</b> , Tracheal-Häkchen	243
<b>HURD</b> , Dissektoren	248

**I**

Instrumente für die Stapes-Fußplatte	296, 297
Instrumente zur Nasenplastik	339, 346, 356
Instrumente, Sensibilitäts-	188
Instrumentenablageplatten	361
Instrumentenkästen	363
Inzisionsscheren	64
Irisscheren	76
<b>ITERSON</b> , Tracheal-Häkchen	242

**J**

<b>JACKSON</b> , Kaltlichtlaryngoskope	178
<b>JACKSON</b> , Tracheal-Häkchen	243
<b>JACKSON-CHEVALIER</b> , Tracheal-Kanülen	244
<b>JACOBI</b> , Unterbindungsnadeln	125
<b>JACOBSON</b> , Hartmetallnadelhalter <b>TUC</b>	109
<b>JALASVIRTA</b> , Ohrpinzetten	52
<b>JANET</b> , Spritzen	161
<b>JANSEN (GRUENDWALD)</b> , Nasen-Pinzette	52
<b>JANSEN</b> , Elevatorien	299
<b>JANSEN</b> , Nasenpinzetten	52
<b>JANSEN</b> , Ohrlöffel	289
<b>JANSEN</b> , scharfe Löffel	214
<b>JANSEN</b> , Wundsperrerr	149
<b>JANSEN-MIDDLETON</b> , scharfe Nasenzangen	329
<b>JANSEN-ZAUFAL</b> , Hohlmeißelzangen	225
<b>JATHO</b> , Nasenzangen	331

<b>JENNINGS</b> , Mundsperrerr	231
<b>JEWELER</b> , Hartmetallpinzetten <b>TUC</b>	56
<b>JOBSON-HORNE</b> , Watteträger	155
<b>JOHNS-HOPKINS</b> , Anlegezangen	19
<b>JOHNS-HOPKINS</b> , Bulldogklemmen	19
<b>JONES</b> , Tuchklemmen	30
<b>JOSEPH</b> , Elevatorien	337
<b>JOSEPH</b> , feine Wundhaken	139, 344
<b>JOSEPH</b> , Instrumente zur Nasenplastik	339, 356
<b>JOSEPH</b> , Nasenplastik- und Operationsmesser	334
<b>JOSEPH</b> , Nasenraspeln	340
<b>JOSEPH</b> , Präparierscheren	71
<b>JOSEPH-MASING</b> , Elevatorien	337
<b>KABIERSKE</b> , Pulverbläser	305
<b>KALT</b> , Hartmetallmikronadelhalter <b>TUC</b>	117
<b>KALT</b> , Mikronadelhalter mit Hartmetall, <b>TUC</b>	117

**K**

Kaltlichtkabel	411
Kaltlichtlaryngoskope	167-170, 178
Kaltlichtträger	213
Kanülen	156-162
Katheterzangen	171
<b>KAYE</b> , Face-Lift-Scheren <b>TUC</b>	93
<b>KAZANJIAN</b> , Nasenzangen	331
Kehlkopfpolypenzangen	273
Kehlkopfspiegel	271
Keilbeinstanzen	332, 333
<b>KELLY</b> , Arterienklemmen	24
<b>KELLY-RANKIN</b> , Arterienklemmen	24
<b>KELLY-RICHARDSON</b> , Wundhaken	145
<b>KELMAN-McPHERSON</b> , Nahtpinzetten	53
<b>KERRISON</b> , Keilbeinstanzen	332
<b>KILLIAN</b> , Elevatorien	338
<b>KILLIAN</b> , Hohlmeißel	348
<b>KILLIAN</b> , Nasenspekula	312
<b>KILLIAN</b> , Polypenzangen	315
<b>KILLIAN</b> , Septumschere	272
<b>KILLIAN-CLAUS</b> , Hohlmeißel	348
<b>KILLIAN-EICKEN</b> , Saugrohre	159
<b>KILNER</b> , feine Wundhaken	135, 345
<b>KILNER</b> , Hartmetallnadelhalter <b>TUC</b>	110
<b>KILNER</b> , Nadelhalter	103
<b>KILNER-DOUGHTY</b> , Mundsperrerr	232
<b>KILNER-RAGNELL</b> , Präparierscheren	71
Klammern, Wund-	127
<b>KLEINERT-KUTZ</b> , feine Wundhaken	135
<b>KLEINERT-KUTZ</b> , Hohlmeißelzangen	225
Klemmen	15-32
Klemmen, Arterien-	21-28
Klemmen, Bulldog-	18, 19
Klemmen, Kopfhaut-	28
Klemmen, Ligatur- und Präparier-	29
Klemmen, Präparier- und Ligatur-	29
Klemmen, Schlauch-	32
Klemmen, Tuch-	30, 31
Klingenbrecher	100
<b>KLINIKUM BERLIN</b> , Schlauchklemmen	32
<b>KNAPP</b> , feine Wundhaken	139
<b>KNIGHT</b> , Siebbein- und Septumzangen	330
<b>KNIGHT-HEYMANN</b> , Polypenzangen	315
Knochensplitterzangen	226, 227
<b>KOCHER</b> , Sonden	246
<b>KOCHER</b> , Wundhaken	142, 144
<b>KOCHER-DELICATE</b> , Arterienklemmen	27
<b>KOCHER-LANGENBECK</b> , Wundhaken	143
<b>KOCHER-OCHSNER</b> , Arterienklemmen	26
<b>KOFFLER-HAJEK</b> , Keilbeinstanzen	332
Kopfhautklemmen	28
Kornzangen	131, 132
<b>KRAUSE</b> , Aufsätze	257





	Seite		Seite
<b>KRAUSE</b> , Polypenschnürer	282, 314	<b>LITTAUER-LISTON</b> , Knochensplitterzangen	226
<b>KRAUSE-VOSS</b> , Polypenschnürer	282, 314	<b>LITTLE</b> , Wundhaken	144
<b>KRESSNER</b> , Instrumente zur Nasenplastik	356	<b>LITTLER</b> , feine Scheren	75
<b>KROENIG</b> , Zungendrücker	239	<b>LOCKHART-MUMMERY</b> , Sonden	154
<b>KROENLEIN</b> , Fasszangen	20	Löffel	289, 347, 348
<b>KRONECKER</b> , Unterbindungsnadeln	125	<b>LOPEZ-REINKE</b> , Dissektoren	249
<b>KRONE-MARSCHIK</b> , Tonsillenzangen	252	<b>LORNA</b> , Tuchklemme	31
Kropffasszangen	246	<b>LOVELACE-DIXON</b> , Arterienklemmen	28
Kropfscheren	73	<b>LUBET-BARBON</b> , Polypenzangen	315
<b>KUHN-BOLGER</b> , Küretten	347	<b>LUC</b> , Siebbein- und Septumzangen	330
Küretten	210-214	<b>LUCAE</b> , Hämmer	208
<b>KUTZ-KLEINERT</b> , feine Wundhaken	135	<b>LUCAE</b> , Nasenpinzetten	52
<b>KUTZ-KLEINERT</b> , Hohlmeisselzangen	225	<b>LUCAE</b> , Ohrhäkchen	290
		<b>LUCAE</b> , Parazentesenadeln	291
<b>L</b>		<b>LUCAE</b> , Stimmgabeln	303
		<b>LUCAS</b> , Meißel	197
<b>LA FORCE</b> , Adenotome	354	<b>LUER</b> , Hohlmeisselzangen	223
<b>LABORDE</b> , Dilatatoren	241	<b>LUER</b> , Tracheal-Häkchen	243
<b>LACK</b> , Zungendrücker	238	<b>LUER</b> , Tracheal-Kanülen	244
<b>LAHEY</b> , Kropffasszangen	246	Luftdusche	305
<b>LAHEY</b> , Wundhaken	144	<b>LUKENS</b> , Tracheal-Häkchen	242
<b>LAMBOTTE</b> , Osteotome	206	<b>LUNIATSCHECK</b> , Dissektoren	249
<b>LAMBOTTE-MINI</b> , Osteotome	206		
Lampen, Stirn-	181-185	<b>M</b>	
<b>LANE</b> , chirurgische Pinzetten	38	<b>MACKAY</b> , Küretten	347
<b>LANE</b> , Tuchklemmen	30	<b>MACKAY</b> , Sichelmesser	347
<b>LANGE</b> , Aufsätze	257	<b>MAGILL</b> , Katheterzangen	171
<b>LANGE</b> , feine Wundhaken	344	<b>MALTZ</b> , Nasenraspeln	340
<b>LANGE</b> , Kehlkopfpolypenzangen	273	<b>MARLIN</b> , Nahtmaterial	250
<b>LANGE</b> , Wundklammerpinzetten	127	<b>MARQUARDT</b> , Hohlmeisselzangen	224
<b>LANGENBECK</b> , Elevatorien	216	<b>MARSCHIK</b> , Tonsillen-Pinzette	250
<b>LANGENBECK</b> , Fingerschützer	230	<b>MARSCHIK-KRONE</b> , Tonsillenzangen	252
<b>LANGENBECK</b> , Hartmetallnadelhalter <b>TUC</b>	116	<b>MARTEL</b> , Gefäßklemme	20
<b>LANGENBECK</b> , Nadelhalter	107	<b>MARTIN</b> , Nasenspekula	312
<b>LANGENBECK</b> , Ohrküretten	289	<b>MARTIN/BERCHTOLD</b> , Anschlusskabel	406
<b>LANGENBECK</b> , Raspatorien	215	<b>MARTIN/BERCHTOLD</b> , Elektrohandgriffe	404
<b>LANGENBECK-DELICATE</b> , Hartmetallnadelhalter <b>TUC</b>	116	<b>MARTIN/BERCHTOLD</b> , Elektrohandgriffe mit Kabel	405
<b>LANGENBECK-KOCHER</b> , Wundhaken	143	<b>MARTINI</b> , scharfe Löffel	214
<b>LANGENBECK-MINI</b> , feine Wundhaken	140	<b>MARYLAND</b> , Stumpfe Präparation	397
<b>LANGENBECK-RYDER</b> , Hartmetallnadelhalter <b>TUC</b>	116	<b>MASING</b> , Elevatorien	338
<b>LANGE-WILDE</b> , Polypenschnürer	282, 314	<b>MASING</b> , feine Wundhaken	345
<b>LARKIN</b> , Instrumente für die Stapes-Fußplatte	296	<b>MASING</b> , Flachmeißel	352
Laryngo-Bronchoskopie-Zangen	267	<b>MASING</b> , Nasenplastik- und Operationsmesser	334
Laryngoskope	163-166	<b>MASING</b> , Nasenraspeln	341
Laryngoskope, Kaltlicht-	167-170, 178	<b>MASING-JOSEPH</b> , Elevatorien	337
Laryngoskope, Operations-	172-180	<b>MASS-GENERAL-HOSPITAL (M.G.H.)</b> , Nadelhalter	105
Laryngo-Zangen	272	<b>MASTIN</b> , Muskelklemme	246
<b>LEMPERT</b> , Elevatorien	298	<b>MATHIEU</b> , Hartmetallnadelhalter <b>TUC</b>	113
<b>LEMPERT</b> , Hohlmeißelzangen	224	<b>MATHIEU</b> , Nadelhalter	106
<b>LEMPERT</b> , Küretten	298	<b>MATHIEU-DELICATE</b> , Hartmetallnadelhalter <b>TUC</b>	114
<b>LEMPERT</b> , Raspatorien	298	<b>MATHIEU-DELICATE</b> , Nadelhalter	106
<b>LERICHE</b> , Arterienklemmen	23	<b>MATHIEU-RYDER</b> , Hartmetallnadelhalter <b>TUC</b>	114
<b>LEWIS</b> , Nasenraspeln	340, 343	<b>MATHIEU-RYDER-VASCULAR</b> , Hartmetallnadelhalter <b>TUC</b>	114
<b>LEXER</b> , Hartmetallscheren <b>TUC</b>	90	<b>MAUNDER</b> , Mundkeil	230
<b>LEXER</b> , Meißel	202, 203	<b>MAYER-DAVIS</b> , Mundsperrer	235
<b>LEXER</b> , Osteotome	202, 203	<b>MAYFIELD</b> , Hohlmeißelzangen	224
<b>LEXER</b> , Präparierscheren	70	<b>MAYO</b> , Hartmetallscheren <b>TUC</b>	87
<b>LEXER-BABY</b> , Präparierscheren	71	<b>MAYO</b> , Scheren	65
<b>LEXER-MINI</b> , Meißel	202	<b>MAYO</b> , Sterilisierklammern	364
<b>LEXER-MINI</b> , Osteotome	202	<b>MAYO</b> , Zungendrücker	239
<b>LICHTENBERG</b> , Hartmetallnadelhalter <b>TUC</b>	115	<b>MAYO-HEGAR</b> , Hartmetallnadelhalter <b>TUC</b>	108
<b>LICHTWITZ</b> , Trokare	156	<b>MAYO-HEGAR</b> , Nadelhalter	105
Ligatur- und Präparierklemmen	29	<b>MAYO-HEGAR-DELICATE</b> , Hartmetallnadelhalter <b>TUC</b>	108
Ligaturscheren	77, 78	<b>MAYO-HEGAR-DELICATE</b> , Nadelhalter	105
Lippen- und Wangenhalter	238, 239	<b>MAYO-STILLE</b> , Hartmetallscheren <b>TUC</b>	88
<b>LISTER</b> , Hartmetallscheren <b>TUC</b>	93	<b>MAYO-STILLE</b> , Scheren	65
<b>LISTER</b> , Tupferzangen	130	<b>MC INDOE</b> , Instrumente zur Nasenplastik	346
<b>LISTON</b> , Knochensplitterzangen	226	<b>MC INDOE</b> , Knochensplitterzangen	227
<b>LISTON-RUSKIN</b> , Knochensplitterzangen	227	<b>MC INDOE</b> , Pinzetten	37
<b>LISTON-WALTON</b> , Knochensplitterzangen	227	<b>MC INTOSH FIBRE OPTIC</b> , Laryngoskope	167
<b>LITTAUER</b> , Cilienpinzetten	51	<b>MC INTOSH</b> , Laryngoskope	163
<b>LITTAUER</b> , Ligaturscheren	77		



<b>MC IVOR</b> , Mundsperrerr	234
<b>MCDONALD</b> , Elevatorien	217
<b>MC GEE</b> , Mikro Ohrzängchen	286
<b>MC GEE</b> , Ohrhäkchen	293
<b>MCKENTY</b> , Elevatorien	337
<b>MCKERNAN</b> , Fasszange	399
<b>MCKESSON</b> , Mundkeile	237
<b>MCPHERSON</b> , Nahtpinzetten	53
<b>MCPHERSON-KELMAN</b> , Nahtpinzetten	53
<b>MEAD</b> , Hämmer	208
<b>MEAD</b> , Hohlmeißelzangen	223
Meißel	197-206, 299, 348-352
Messapparate, Blutdruck-	191
Messbecher	360
Messer	291, 334, 347
Messer, Tonsillen-	247
Metallkamm	364
<b>METZENBAUM</b> , Endoskopie-Scheren	396, 400
<b>METZENBAUM</b> , Hartmetallnadelhalter <b>TUC</b>	114
<b>METZENBAUM</b> , Hartmetallscheren <b>TUC</b>	88, 89
<b>METZENBAUM</b> , Präparierscheren	65, 66
<b>METZENBAUM-BABY</b> , Präparierscheren	66
<b>METZENBAUM-DELICATE</b> , Hartmetallscheren <b>TUC</b>	90, 91
<b>METZENBAUM-DELICATE</b> , Präparierscheren	68
<b>METZENBAUM-NELSON</b> , Präparierscheren	67
<b>MEYERDING</b> , feine Wundhaken	140
<b>MICHEL</b> , Kehlkopfspiegel	271
<b>MICHEL</b> , Wundklammern	127
<b>MICHEL</b> , Wundklammerpinzetten	126
<b>MICRO-ADSON</b> , Pinzetten	36
<b>MICRO-MOSQUITO</b> , Arterienklemmen	22
<b>MICRO-RYDER</b> , Hartmetallnadelhalter <b>TUC</b>	108
<b>MICROVASCULAR</b> , Hartmetallnadelhalter <b>TUC</b>	149
<b>MICRO-WULLSTEIN</b> , Saugrohre	159
<b>MIDDELDORPF</b> , Wundhaken	145
<b>MIDDLETON-JANSEN</b> , scharfe Nasenzangen	329
Mikro Ohrzängchen	285-288
Mikroinstrumente	295
Mikronadelhalter	117-123
Mikronadelhalter mit Rundgriff	118-122
Mikropinzetten	46, 47
Mikroscheren	79-84
Mikroscheren, Adventitia	80, 82
Mikroscheren, Dissection	80, 82
<b>MILLARD(COTTLE)</b> , feine Wundhaken	345
<b>MILLER FIBRE OPTIC</b> , Laryngoskope	169
<b>MILLER</b> , Laryngoskope	165
<b>MILLER-COLBURN</b> , Nasenraspeln	342
<b>MILLER-SENN</b> , feine Wundhaken	141
<b>MILLER-SENN-BABY</b> , feine Wundhaken	141
<b>MILLIGAN</b> , Mundsperrerr	151
<b>MINI</b> , Skalpellgriffe	98
<b>MINI-FRIEDMAN</b> , Hohlmeißelzangen	222
<b>MINI-LAMBOTTE</b> , Osteotome	206
<b>MINI-LANGENBECK</b> , feine Wundhaken	140
<b>MINI-LEXER</b> , Meißel	202
<b>MINI-LEXER</b> , Osteotome	202
<b>MINI-RUSKIN</b> , Hohlmeißelzangen	225
<b>MIXTER</b> , Scheren	64
<b>MIXTER-BABY</b> , Präparier- und Ligaturklemmen	29
<b>MIXTER-O'SHAUGNESSY</b> , Präparier- und Ligaturklemmen	29
<b>MOD.BONN</b> , feine Scheren	76
<b>MOD.BONN</b> , Nahtpinzetten	54
<b>MOD.TÜBINGEN</b> , Nahtpinzetten	54
<b>MOD.WIEN</b> , Nasenspekula	312
<b>MOD.WÜRZBURG</b> , Mundsperrerr	234
<b>MODELL USA</b> , Pinzetten	36
<b>MOLDESTAD</b> , feine Wundhaken	137
<b>MOLLISON</b> , Dissektoren	249
<b>MOLLISON</b> , Mundsperrerr	151
<b>MOLT</b> , Mundsperrerr	230
<b>MORITZ-SCHMIDT</b> , Zungendrucker	238

<b>MOSHER-WAGENER</b> , Intubationsrohr	243
<b>MOSQUITO-HALSTED</b> , Arterienklemmen	22
<b>MOSQUITO-MICRO</b> , Arterienklemmen	22
<b>MUCK</b> , Messer	299
<b>MULDOON</b> , Speichelgangdilatoren	275
<b>MUMMERY-LOCKHART</b> , Sonden	154
Mundkeile	230, 237
Mundsperrerr	230-236
Mundspiegelansätze	269, 270
Mundspiegelgriffe	268
<b>MURRAY-CRILE</b> , Nadelhalter	104
<b>MUSEUX</b> , Tonsillenzangen	252
Muskelklemme	246
<b>MYLES</b> , Spülkanülen	335
<b>MYRTLE-LEAF</b> , Sonden	151

**N**

Nadelhalter	102-116
Nadelhalter, Endoskopie-	397
Nadelhalter, Hartmetall <b>TUC</b> -	108-119
Nadelhalter, Mikro-	117-123
Nadeln, Reverdin-	124
Nadeln, Unterbindungs-	124, 125
Nadel-Sterilisierkästen	361
<b>NAGER</b> , Tonsillenretraktor	251
Naht	101-128
Naht-Instrument	107
Nahtpinzetten	53, 54, 126, 127
Narkose	163-180
Nasen- und Ohrpinzetten	52
Nasenrachen-Spekulum	312
Nasenraspeln	340-343
Nasenscheren	73
Nasenspekula	311-313
Nasenzangen	327-329
<b>NEGUS(BECKMANN)</b> , Ringmesser	353
<b>NEGUS</b> , Bruststütze für Mundsperrerr	236
<b>NEGUS</b> , Saug-Elevatorien	335
<b>NEIVERT</b> , Hartmetallnadelhalter <b>TUC</b>	110
<b>NEIVERT</b> , Nadelhalter	103
<b>NEIVERT</b> , Osteotome	352
<b>NEIVERT-ANDERSON</b> , Osteotome	352
<b>NEIVERT-COTTLE</b> , feine Wundhaken	345
<b>NELATON</b> , Sonden	153
<b>NELSON-METZENBAUM</b> , Präparierscheren	67
<b>NEW ORLEANS</b> , Hartmetallnadelhalter <b>TUC</b>	109
<b>NEWS</b> , Tracheal-Häkchen	243
Nierenschalen	360
<b>NIJMEGEN</b> , Saugrohre	159
<b>NOLST-TRENITÉ JOSEPH</b> , Instrumente zur Nasenplastik	339
<b>NOLST-TRENITÉ</b> , Osteotome	350
<b>NORTHBENT</b> , Ligaturscheren	78
<b>NOYES-HARTMANN</b> , Ohrzängchen	284
Nystagmusbrillen	186, 187

**O**

<b>O'BRIAN</b> , feine Scheren	76
<b>O'CONNOR</b> , feine Wundhaken	136
<b>OBWEGESER</b> , Osteotome	352
<b>OBWEGESER</b> , Wundhaken	143
<b>OCHSNER-KOCHER</b> , Arterienklemmen	26
<b>OEHLER</b> , Hartmetallpinzetten <b>TUC</b>	56
Ohr- und Nasenpinzetten	52
Ohrhäkchen	290, 292, 293
Ohrküretten	289, 298, 299
Ohrlöffel	289
Ohrnadeln	291-293
Ohrschlingen	290
Ohrspekula	278-281
Ohrspritzen	306

	Seite		Seite
Ohrzängchen	283, 284	Punktion/Kanülen	156-162
Ohrzängchen, Mikro-	284-288	<b>PYE-SMITH (HARRISON)</b> , Sterilisierzangen	364
<b>OLSEN-HEGAR</b> , Hartmetallnadelhalter <b>TUC</b>	113	<b>PYNCHON-ANDREWS</b> , Saugrohre	157
<b>OLSEN-HEGAR</b> , Nadelhalter	106	<b>Q</b>	
<b>OLYMPUS</b> , Adapter	411	Quetschzangen	307
Operations-Laryngoskope	172-180	<b>QUIRE</b> , Ohrzängchen	283
Optischer Retraktor	148	<b>R</b>	
Orthopädie	195-228	<b>RAGNELL-DAVIS</b> , feine Wundhaken	141
Osteotome	197-206, 299, 349-352	<b>RAGNELL-KILNER</b> , Präparierscheren	71
Oto-/Ophthalmoskop	193	<b>RALK</b> , Splitterpinzetten	50
<b>OTOSKOP UNI</b> , Diagnostikbesteck	193	<b>RAMPLEY</b> , Schwammzangen	134
Otoskop, Video-	194	<b>RANKIN-CRILE</b> , Arterienklemmen	24
<b>P</b>		<b>RANKIN-KELLY</b> , Arterienklemmen	24
Parazentesenadeln	291	Raspatorien	215, 216, 298
<b>PARKER</b> , Wundhaken	147	<b>REICHERT</b> , Epiglottis Wundhaken	272
<b>PARTSCH</b> , Hämmer	208	<b>REILL</b> , Mikronadelhalter	120
<b>PARTSCH</b> , Meißel	198	<b>REINKE-LOPEZ</b> , Dissektoren	249
<b>PASSOW</b> , Meißel	299	Repositionszangen	228
<b>PAUFIQUE</b> , Nahtpinzetten	54	Reverdin, Nadeln	124
Paukenröhrchen	307	<b>REYNOLDS</b> , Präparierscheren	72
<b>PAULSEN</b> , Spülkanülen	335	<b>RICHARDSON-KELLY</b> , Wundhaken	145
<b>PEAN</b> , Faszangen	20	<b>RICHTER</b> , Scheren	64
<b>PEAN-DELICATE</b> , Arterienklemmen	27	<b>RICHTER-HEATH</b> , Wundklammerzängchen	126
<b>PEAN-ROCHESTER</b> , Arterienklemmen	25	<b>RING</b> , Mundsperrer	234
<b>PEERS</b> , Tuchklemmen	31	Ringmesser	353, 354
<b>PEET</b> , Splitterpinzetten	50	<b>RIRAP</b> , Stethoskop	189
<b>PENNINGTON</b> , Faszangen	20	<b>RITTER-HALLE</b> , Stirnhöhlen-Dilatator	335
<b>PENNINGTON</b> , Instrumente zur Nasenplastik	339	<b>ROCHESTER-PEAN</b> , Arterienklemmen	25
<b>PERWITZSCHKY</b> , feine Scheren	74, 275	<b>RÖDER</b> , Tonsillen-Nahtinstrument	250
<b>PETERSEN-SMITH</b> , Meißel	199	<b>ROEDER</b> , Tuchklemmen	31
<b>PETERSEN-SMITH</b> , Osteotome	199	<b>ROGER</b> , Septum-Elevatorien	336
<b>PIERCE</b> , Instrumente zur Nasenplastik	339	<b>ROGGE</b> , Sterilisierzangen	364
<b>PIFFARD</b> , scharfe Löffel	212	<b>ROLLET</b> , feine Wundhaken	139
<b>PILCHER</b> , Nasenspekula	312	<b>ROSE</b> , Tracheal-Häkchen	243
Pinzetten, anatomisch	34-42	<b>ROSEN</b> , Messer	294
Pinzetten, chirurgisch	34-42	<b>ROSEN</b> , Mikroinstrumente	295
Pinzetten, Cilien-	51	<b>ROSEN</b> , Ohrnadeln	292, 293
Pinzetten, Fass-	43, 44, 397-400	<b>ROSER-KÖNIG</b> , Mundsperrer	231
Pinzetten, Hartmetall <b>TUC</b>	56-58	<b>ROUX</b> , Wundhaken	146
Pinzetten, Mikro-	46, 47	<b>ROWE</b> , Repositionszange	228
Pinzetten, Naht-	53, 54, 126, 127	<b>RUBIN</b> , Instrumente zur Nasenplastik	356
Pinzetten, Ohr- und Nasen-	52	<b>RUBIN</b> , Osteotome	351
Pinzetten, Splitter-	48-50	<b>RUSKIN</b> , Hohlmeißelzangen	225
Pinzetten, Uhrmacher-	45	<b>RUSKIN-LISTON</b> , Knochensplitterzangen	227
Pinzetten, Wundklammer-	127	<b>RUSKIN-MINI</b> , Hohlmeißelzangen	225
<b>PITHA</b> , Mundkeil	230	<b>RUSS.MODELL</b> , Fasspinzetten	44
<b>PLESTER</b> , Messer	294	<b>RYDER-FRENCH-EYE</b> , Hartmetallnadelhalter <b>TUC</b>	108
<b>PLESTER</b> , Mikroinstrumente	295	<b>RYDER-MATHIEU VASCULAR</b> , Hartmetallnadelhalter <b>TUC</b>	114
<b>PLESTER</b> , Saugrohre	159	<b>RYDER-MATHIEU</b> , Hartmetallnadelhalter <b>TUC</b>	114
<b>PLESTER</b> , Wundsperrer	152	<b>RYDER-MICRO</b> , Hartmetallnadelhalter <b>TUC</b>	108
<b>POLITZER</b> , Luftdusche	305	<b>S</b>	
<b>POLITZER</b> , Messer	291	<b>SANVENERO</b> , Präparierscheren	71
<b>POLITZER</b> , Ohrspekula	278	<b>SAROT</b> , Hartmetallnadelhalter <b>TUC</b>	111
<b>POLITZER</b> , Parazentesenadeln	291	<b>SAROT</b> , Nadelhalter	104
Polypenschnürer	282, 314	<b>SAUERBRUCH</b> , Wundhaken	144
Polypenzangen	272, 273, 315	Saug-Elevatorien	335
<b>POOLE</b> , Saugrohre	158	Saugrohre	157-160, 300, 301
<b>POOLE-BABY</b> , Saugrohre	158	<b>SCALP-CONTOUR</b> , Wundsperrer	152
<b>POTTS-SMITH</b> , Hartmetallpinzetten <b>TUC</b>	56	<b>SCHAEDEL</b> , Tuchklemmen	30
<b>POTTS-SMITH</b> , Pinzetten	40	<b>SCHÄFER</b> , Wundhaken	358
Präparier- und Ligaturklemmen	29	Schalen	360, 363
Präparierscheren	65-72	Scharfe Löffel	210-214
<b>PRATT</b> , Fistelsonden	154	Scharfe Nasenzangen	327-329
<b>PRATT</b> , Küretten	347	Scharfe Präparation	396, 400
<b>PRECISA</b> , Blutdruckmessapparate	191	Scharfe Tonsillenzangen	255
<b>PRESBYTERIAN</b> , Schlauchklemmen	32	<b>SCHEDE</b> , scharfe Löffel	211
<b>PRINCE</b> , Tonsillenscheren	72		
<b>PROVIDENCE-HOSPITAL</b> , Arterienklemmen	23		
Pulverbläser	305		
Punktion	156-162		



	Seite		Seite
<b>SCHEINMANN</b> , Aufsätze	257	Sonden	153-155, 274
Scheren	59-94	<b>SONNENSCHNEID</b> , Nasenspekula	312
Scheren, Chirurgische-	62-65	Speichelgangdilatatoren	275
Scheren, Endoskopie-	396	Speichelgangsonden	274
Scheren, fein	74-77	<b>SPENCER</b> , Ligaturscheren	77
Scheren, Hartmetall <b>TUC</b>	85-93	<b>SPENCER-DELICATE</b> , Ligaturscheren	77
Scheren, Kropf-	73	<b>SPENCER-WELLS</b> , Arterienklemmen	21
Scheren, Ligatur-	77, 78	Spiegel, Kehlkopf-	271
Scheren, Mikro-	79-84	Spiegel, Postrhinoskopie-	272
Scheren, Nasen-	73	Spiegel, Stirn-	181, 183
Scheren, Nerv-Präparier-	70	Spiegelansätze, Mund-	269, 270
Scheren, Präparier-	65-72	Splitterpinzetten	48-50
Scheren, Supercut <b>SC</b>	61	<b>SPRATT</b> , scharfe Löffel	211
Scheren, Tonsillen-	72	Spritzen	161, 306
<b>SCHINK</b> , Dermatom	99	Spülkanülen	335
Schlauchklemmen	32	<b>ST.BARTHOLOMEW</b> , Nasenzangen	331
Schlingen	290	<b>ST.CLAIR-THOMPSON</b> , Postrhinoskopie-Spiegel	272
<b>SCHMEDEN</b> , scharfe Nasenzangen	328	<b>ST.CLAIR-THOMPSON</b> , Ringmesser	354
<b>SCHMEDEN</b> , scharfe Tonsillenzangen	255	<b>ST.MARTIN</b> , Nahtpinzetten	53
<b>SCHMIDT-MORITZ</b> , Zungendrucker	238	<b>STACKE</b> , Sonden	153
<b>SCHOEMAKER</b> , Kropfscheren	73	<b>STAMMBERGER</b> , Sinuskopie-Zangen	324
<b>SCHOENBORN</b> , Tracheal-Häkchen	242	<b>STANDARD</b> , anatomische Pinzetten	34
<b>SCHUHKNECHT</b> , Biegegerät für Stapes-Drahtprothesen	297	<b>STANDARD</b> , chirurgische Pinzetten	34
<b>SCHUKNECHT</b> , Messer	294	<b>STANDARD</b> , Chirurgische Scheren	62
<b>SCHUKNECHT(BARON)</b> , Saugrohre	300	<b>STANDARD</b> , Hartmetallscheren <b>TUC</b>	86, 87
<b>SCHUHKNECHT</b> , Wundsperrerr	151	<b>STANDARD</b> , Pinzetten	34
<b>SCHUMACHER</b> , Aufsätze	257	<b>STANDARD</b> , Zungendrucker	239
Schwammzangen	130-134	Standgefäße	363
<b>SCHWECKENDICK-GOOD</b> , Tonsillenscheren	72	Stanzen	288, 320, 321, 332, 333
<b>SEBILEAU</b> , Elevatorien	216	Stanzen, Endoskopie-	396
<b>SECCO</b> , Mundspiegelgriffe	268	<b>STELLBRINK</b> , Hohlmeißelzangen	222
<b>SEIFFERT</b> , Aufsätze	257	Sterilisierklammern	364
Selbsthaltende Wundsperrerr	149-152	Sterilisierzangen	364
<b>SELECT/ERBE</b> , Anschlusskabel	406	<b>STERNBERG</b> , Wangen- und Lippenhalter	238
<b>SEMKEN</b> , Hartmetallpinzetten <b>TUC</b>	56	<b>STERNUM</b> , Hartmetalldrahtzangen <b>TUC</b>	116
<b>SEMKEN</b> , Pinzetten	37, 38	Stethoskope	189, 190
<b>SENN-GREEN</b> , feine Wundhaken	140	<b>STEVENS</b> , Hartmetallscheren <b>TUC</b>	92
<b>SENNING (SCHWED.MODELL)</b> , Nadelhalter	105	<b>STEVENS</b> , Sehnenscheren	77
<b>SENNING(SCHWED.MODELL)</b> , Hartmetallnadelhalter <b>TUC</b>	109	<b>STIEGLITZ</b> , Splitterpinzetten	50
<b>SENN-MILLER</b> , feine Wundhaken	141	<b>STIERLEN</b> , Zungendrucker	241
<b>SENN-MILLER-BABY</b> , feine Wundhaken	141	<b>STILLE</b> , Meißel	201
Sensibilitätsinstrumente	188	<b>STILLE</b> , Osteotome	201
Septum- und Periost-Elevatorien	336-338	<b>STILLE</b> , Pinzetten	42
Septum- und Siebbeinzangen	330	<b>STILLE-MAYO</b> , Hartmetallscheren <b>TUC</b>	88
<b>SEPTUM</b> , Septumnadel	335	<b>STILLE-MAYO</b> , Scheren	65
Septummesser	336	Stimmgabeln	303, 304
Septumnadel	335	Stirnhöhlen-Dilatator	335
Septumrichtzangen	355	Stirnhöhlenstanze	317
<b>SEWALL</b> , Küretten	347	Stirnlampen	181-185
<b>SHAMBAUGH</b> , Ohrhäkchen	292	Stirnspiegel	181, 183
<b>SHAMBAUGH-DERLACKI</b> , Raspatorien	298	<b>STORZ</b> , Adapter	412
<b>SHAPLEIGH</b> , Ohrküretten	289	<b>STRÜMPFEL</b> , Ohrzängchen	284
<b>SHEA</b> , Instrumente für die Stapes-Fußplatte	296	<b>STRUYCKEN</b> , scharfe Nasenzangen	328, 329
<b>SHEEHAN</b> , Osteotome	351	<b>STRUYCKEN</b> , Sinuskopie-Zangen	319
<b>SHORTBENT</b> , Ligaturscheren	78	<b>STRYKER</b> , Adapter	412
Siebbein- und Septumzangen	330	Stumpfe Präparation	397
<b>SIEGLE</b> , Ohrspekula	281	<b>SULLIVAN-BROPHY</b> , feine Scheren	75
<b>SILVER</b> , Dermatom	100	Super Cut Scheren	61
<b>SILVER</b> , Osteotome	352	<b>SYME</b> , Unterbindungsadeln	124
<b>SIMPLEX</b> , Wangenhalter	238		
<b>SINUSCOPY</b> , Trokare	156	<b>T</b>	
Sinuskopie-Zangen	318-327	<b>TABB</b> , Messer	294
Skalpelli	96-98	<b>TAKAHASHI</b> , scharfe Nasenzangen	329
<b>SLUDER-BALLENGER</b> , Tonsillotom	253	<b>TAKAHASHI</b> , Sinuskopie-Zangen	319
<b>SMITH-FERRIS</b> , Keilbeinstanzen	333	<b>TAYLOR</b> , Pinzetten	38
<b>SMITH-FERRIS</b> , Pinzetten	42	<b>TAYLOR-CUSHING</b> , Hartmetallpinzetten <b>TUC</b>	57
<b>SMITH-PETERSEN</b> , Meißel	199	<b>TERRIER</b> , Arterienklemmen	21
<b>SMITH-PETERSEN</b> , Osteotome	199	<b>THIESS</b> , Hämmer	208
<b>SMITH-POTTS</b> , Hartmetallpinzetten <b>TUC</b>	56	<b>THOMPSON-ST.CLAIR</b> , Postrhinoskopie-Spiegel	272
<b>SMITH-POTTS</b> , Pinzetten	40	<b>THOREK</b> , Präparierscheren	70
<b>SNELLEN</b> , Ohrschlingen	290	<b>THUDICHUM(GOLDSMITH)</b> , Nasenspekula	313
<b>SNITMAN</b> , Wundsperrerr	149		



	Seite		Seite
<b>TIECK-HALLE</b> , Nasenspekula	311	<b>WALSHAM</b> , Septumrichtzangen	355
<b>TILLEY</b> , Ohrzängchen	283	<b>WALTER(AUFRICHT)</b> , Instrumente zur Nasenplastik	346
<b>TIVNEN</b> , Tonsillenzangen	252	<b>WALTER</b> , feine Wundhaken	141
<b>TOBOLD</b> , Zungendrücker	238	<b>WALTER</b> , Flachmeissel	351
<b>TOENNIS</b> , Hartmetallnadelhalter <b>TUC</b>	115	<b>WALTER</b> , Osteotome	351
<b>TOENNIS</b> , Nadelhalter	107	<b>WALTON</b> , feine Scheren	76
<b>TOENNIS-ADSON-DELICATE</b> , Hartmetallscheren <b>TUC</b>	93	<b>WALTON-LISTON</b> , Knochensplitterzangen	227
<b>TOHOKU-JAPAN</b> , Tuchklemmen	31	<b>WALTON-YANKAUER</b> , Saugrohre	157
Tonsillenanülen	253	Wangen- und Lippenhalter	238, 239
Tonsillen-Kompressorium	253	<b>WANGENSTEEN</b> , Hartmetallpinzetten <b>TUC</b>	58
Tonsillennmesser	247	<b>WARTENBERG</b> , Sensibilitätsinstrumente	188
Tonsillennadeln	251	<b>WATSON</b> , Dermatom	99
Tonsillen-Nahtinstrument	251	<b>WATSON-WILLIAMS</b> , scharfe Nasenzangen	327
Tonsillennretraktor	251	Watteträger	154, 155
Tonsillenscheren	72	<b>WAUGH</b> , Fassspinzette	43
Tonsillenschnürer	254	<b>WEBSTER</b> , Hartmetallnadelhalter <b>TUC</b>	110
Tonsillenzangen	252	<b>WEBSTER</b> , Nadelhalter	103
Tonsillotom	253	<b>WEERDA</b> , Dilatator	241
<b>TOYNBEE</b> , Ohrspekula	278	<b>WEIL-BLAKESLEY</b> , scharfe Nasenzangen	327
Tracheal-Häkchen	242, 243	<b>WEIL-BLAKESLEY</b> , Sinuskopie-Zangen	318, 319
Tracheal-Kanülen	244	<b>WEINGÄRTNER</b> , Ohrzängchen	284
Tracheotomie-Besteck	245	<b>WEITLANER</b> , Wundsperrer	150
<b>TRELAT</b> , Periot-Elevatorien	336	<b>WEITLANER-BABY</b> , Wundsperrer	150
<b>TREPSAT</b> , Facelift-Schere	69	<b>WELLS-SPENCER</b> , Arterienklemmen	21
<b>TROELTSCH-WILDE</b> , Ohrpinzetten	52	<b>WEST</b> , Flachmeißel	348
Trokare	156, 241	<b>WEST</b> , Hohlmeißel	348
Trokarhülsen und Trokare	393	<b>WESTMACOTT</b> , Polypenzangen	315
<b>TROUSSEAU</b> , Dilatatoren	241	<b>WHITE</b> , Tonsillenzangen	252
<b>TROUTMAN-CHRIS</b> , Klingendreher	100	<b>WHITEHEAD</b> , Mundsperrer	232
<b>TÜBINGEN MODELL</b> , Nahtpinzetten	54	<b>WIEDER</b> , Zungendrücker	238
<b>TÜBINGER MODELL</b> , Wundsperrer	152	<b>WIENER</b> , Nasenraspeln	341
<b>TÜBINGER</b> , Paukenröhrchen	307	<b>WILDE-LANGE</b> , Polypenschnürer	282, 314
Tuchklemmen	30, 31	<b>WILDER</b> , Speichelgangdilatatoren	275
<b>TUFFIER</b> , Fasszangen	20	<b>WILDE-TROELTSCH</b> , Ohrpinzetten	52
Tupferzangen	130-134	<b>WILLIAMS-WATSON</b> , scharfe Nasenzangen	327
<b>TYDING</b> , Tonsillenschnürer	254	<b>WILLIGER</b> , Elevatorien	216
<b>TYDING</b> , Tonsillenzangen	252	<b>WILLIGER</b> , Hämmer	207
<b>U</b>			
<b>UCKERMANN</b> , Trokare	241	<b>WILLIGER</b> , Raspatorien	216
<b>UCKERMANN</b> , Watteträger	155	<b>WILLIGER</b> , scharfe Löffel	214
<b>UFFENORDE</b> , Küretten	348	<b>WILMER</b> , Irisschere	76
Uhrmacherpinzetten	45	<b>WINTER + IBE</b> , Adapter	412
<b>UNI OTOSKOP</b> , Diagnostik-Bestecke	193	<b>WOLF/HENKE-SASS</b> , Adapter	412
<b>UNI-ECONOM</b> , Diagnostik-Bestecke	192	<b>WULLSTEIN MICRO</b> , Saugrohre	159
<b>UNIV. MINNESOTA</b> , Zungendrücker	239	<b>WULLSTEIN</b> , Elevatorien	298
<b>UNIVERSAL</b> , Hohlmeißelzangen	222	<b>WULLSTEIN</b> , Messer	294
Universalgriffe und Aufsätze	256, 257	<b>WULLSTEIN</b> , Mikro Ohrzängchen	288
Unterbindungsnadeln	124, 125	<b>WULLSTEIN</b> , Saugrohre	300
<b>V</b>			
<b>VALLEYLAB</b> , Anschlusskabel	406	<b>WULLSTEIN</b> , Wundsperrer	151
<b>VALLEYLAB</b> , Elektrohandgriffe mit Kabel	405	<b>WULLSTEIN-HARTMANN</b> , Ohrzängchen	284
Verbindungsstücke	162	Wundhaken	135-152, 240, 241, 358
<b>VERHOEVEN</b> , Saugrohre	301	Wundhaken mit Kaltlichtbeleuchtung	148
Verschiedenes und Zubehör	359-364	Wundhaken, fein	135-141
Verschiedenes zur Sterilisation	381-388	Wundklammern	127
Video-Otoskop	194	Wundklammerpinzetten	127
<b>WISE</b> , Knüpfpinzetten mit Plateau	46	Wundklammerzängchen	126
<b>VOLKMANN</b> , scharfe Löffel	210, 214	Wundsperrer, selbsthaltend	149-152
<b>VOLKMANN</b> , Wundhaken	142	<b>WÜRZBURG</b> , Dissektoren	249
<b>VOLTOLINI(DUPLAY)</b> , Nasenspekula	313	<b>Y</b>	
<b>VOSS-KRAUSE</b> , Polypenschnürer	282, 314	<b>YANKAUER</b> , Nasenspekula	312
<b>W</b>			
<b>WACHENFELDT</b> , Wundklammerpinzetten	126	<b>YANKAUER</b> , Saugrohre	157
<b>WAGENER</b> , Ohrhäkchen	290	<b>YANKAUER-WALTON</b> , Saugrohre	157
<b>WAGENER-MOSHER</b> , Intubationsrohr	243	<b>YOUNG</b> , Zungenzangen	240
<b>WAGNER</b> , feine Scheren	74	<b>Z</b>	
Zängchen, Wundklammer-			
Zangen, Draht- mit Hartmetalleinsätzen <b>TUC</b>			
Zangen, Korn-			
Zangen, Schwamm-			
Zangen, Tupfer-			





---

Seite

<b>ZAUFAL</b> , Ohrhäkchen	290
<b>ZAUFAL-JANSEN</b> , Hohlmeißelzangen	225
<b>ZIEGLER</b> , Cilienpinzetten	51
<b>ZÖLLNER</b> , Saugrohre	300
Zoom-Adapter	413
Zubehör für (Laser) Operations-Laryngoskope	177, 179, 180
Zungendrucker	238, 239
Zungenzangen	240, 241

# Index

	Page		Page
<b>A</b>			
<b>ABRAHAM</b> , tonsil knives	247	<b>BARBARA</b> , ear needles	292, 293
Accessories for (laser) operating laryngoscopes	177, 179, 180	<b>BARBON-LUBET</b> , nasal polypus forceps	315
<b>ACM/HEINE</b> , adapter	412	<b>BARNHILL</b> , adenoid curettes	353
Adapter	412	<b>BARON(SCHUKNECHT)</b> , suction tubes	300
Adenoid curettes	353, 354	<b>BARSKY</b> , rhinoplastic instruments	346
Adenotomes	354	<b>BARTH</b> , ear spoons	289
<b>ADLERKREUTZ</b> , tissue forceps	42	<b>BAUMGARTNER</b> , needle holders	105
<b>ADSON</b> , dissecting forceps tungsten <b>TUC</b>	57	<b>BEALES</b> , elevators	299
<b>ADSON</b> , dressing forceps	36, 37	<b>BECKMANN(NEGUS)</b> , adenoid curettes	353
<b>ADSON</b> , needle holders	105	<b>BECKMANN</b> , adenoid curettes	353
<b>ADSON</b> , suction tubes	160	<b>BECKMANN</b> , nasal specula	311
<b>ADSON-BABY</b> , selfretaining retractors	152	<b>BEER</b> , cilia forceps	51
<b>ADSON-BROWN</b> , dressing forceps	37	<b>BELLUCCI</b> , micro ear forceps	287
<b>ADSON-MICRO</b> , dressing and tissue forceps	36	<b>BERCHTOLD/MARTIN</b> , connection cords	406
<b>ADSON-TOENNIS-DELICATE</b> , scissors tungsten <b>TUC</b>	93	<b>BERCHTOLD/MARTIN</b> , electrode handles	404
Adventitia, micro scissors	80, 82	<b>BERCHTOLD/MARTIN</b> , electrode handles with fix cable	405
Air bag	305	<b>BERNHARD</b> , towel forceps	30
<b>ALDERDYCE</b> , elevators	217	<b>BEYER</b> , bone rongeurs	225
<b>ALEXANDER</b> , chisels	198	<b>BEYER</b> , punches	288
<b>ALLIGATOR</b> , laryngeal polypus forceps	273	Bi-Coagulation-Forceps	410
<b>ALLIS</b> , grasping forceps	398	<b>BILLEAU</b> , ear loops	290
<b>ALLIS</b> , tissue seizing forceps	17	Biopsy	396
<b>ALM</b> , retractors	149	Blade breakers	100
<b>ALY</b> , sensibility instruments	188	<b>BLOHMKE</b> , tonsil forceps	252
Anaesthesia	163-180	Blood pressure manometers	191
<b>ANDERSON-NEIVERT</b> , osteotomes	352	<b>BLUMENTHAL</b> , bone rongeurs	223
<b>ANDREWS-PYNCHON</b> , suction tubes	157	Blunt dissection	397
Applicators, cotton	154, 155	<b>BÖHLER</b> , bone rongeurs	225
<b>ARRUGA</b> , needle holder	102	<b>BOIES</b> , rhinoplastic instruments	355
<b>ARRUGA</b> , needle holder tungsten <b>TUC</b>	115	<b>BOLGER-KUHN</b> , sharp curettes	347
Artery forceps	21-28	<b>BONACCOLTO</b> , suture forceps	54
Artery forceps, delicate	27	Bone curettes	210-214
<b>ASCH</b> , septum straightening forceps	355	Bone cutting forceps	226, 227
Aspirating elevator	335	Bone rongeurs	222-225
<b>AUFRICHT GLABELLA</b> , nasal rasps	340	<b>BONNEY</b> , dissecting forceps tungsten <b>TUC</b>	58
<b>AUFRICHT(WALTER)</b> , rhinoplastic instruments	346	<b>BONNEY</b> , grasping forceps	44
<b>AUFRICHT</b> , nasal rasps	340	<b>BOSE</b> , dilators	241
<b>AUFRICHT</b> , periosteal elevator	336	<b>BOSE</b> , trachea retractors	242
<b>AUFRICHT</b> , rhinoplastic instruments	346	<b>BÖTTCHER</b> , tonsil scissors	72
<b>AUFRICHT</b> , rhinoplastic instruments with fibre optic illumination	346	<b>BOUCHERON</b> , ear specula	279
<b>AUSTIN</b> , micro forceps	46	Bowls	360, 363
<b>B</b>			
<b>BABCOCK</b> , grasping forceps	399	<b>BOWMAN</b> , probes	274
<b>BABCOCK</b> , tissue seizing forceps	17	<b>BOYLE-DAVIS</b> , mouth gags	233
<b>BABY-ADSON</b> , selfretaining retractors	152	<b>BOYNTON</b> , needle holders	102
<b>BABY-CRILE-WOOD</b> , needle holders	104	<b>BOYNTON</b> , needle holders tungsten <b>TUC</b>	115
<b>BABY-CRILE-WOOD</b> , needle holders tungsten <b>TUC</b>	111	<b>BRODIE</b> , probes	154
<b>BABY-LEXER</b> , scissors	71	<b>BROPHY(SULLIVAN)</b> , fine scissors	75
<b>BABY-METZENBAUM</b> , scissors	66	<b>BROPHY</b> , dressing and tissue forceps	40
<b>BABY-MILLER-SENN</b> , delicate retractors	141	<b>BROWN</b> , tissue forceps	41
<b>BABY-MIXTER</b> , dissecting and ligature forceps	29	<b>BROWN-ADSON</b> , dressing forceps	37
<b>BABY-POOLE</b> , suction tubes	158	<b>BRUENINGS</b> , ear specula	280
<b>BABY-SENN-MILLER</b> , delicate retractors	141	<b>BRUENINGS</b> , ethmoid and septum forceps	330
<b>BABY-WEITLANER</b> , retractors	150	<b>BRUENINGS</b> , tips	256, 257
<b>BACKHAUS</b> , towel forceps	31	<b>BRUENINGS</b> , tongue depressors	239
<b>BACON</b> , bone rongeurs	224	<b>BRUENINGS</b> , tonsil knives	247
<b>BAINBRIDGE</b> , artery forceps	28	<b>BRUENINGS</b> , tonsil snares	254
<b>BALL &amp; SOCKET</b> , towel forceps	31	<b>BRUENINGS-BRUNK</b> , retractors	358
<b>BALLENGER</b> , gouges	348	<b>BRUNS</b> , bone curettes	210, 213
<b>BALLENGER</b> , septum elevator	336	<b>BRYANT</b> , dressing forceps	130
<b>BALLENGER</b> , septum knives	336	<b>BUCK</b> , ear curettes	289
<b>BALLENGER</b> , tonsil forceps	252	<b>BUCK</b> , ear forceps	283
<b>BALLENGER-FOERSTER</b> , sponge holding forceps	133, 134	<b>BUCK</b> , ligature scissors	78
<b>BALLENGER-SLUDER</b> , tonsillectome	253	<b>BUCKINGHAM</b> , footplate hand instruments	296
		Bulldog clamps	18, 19
<b>C</b>			
		<b>CAIRNS</b> , artery forceps	27



<b>CANFIELD</b> , tonsil knives	247	<b>COTTLE</b> , nasal rasps	340, 343
<b>CAPLAN</b> , nasal scissors	73	<b>COTTLE</b> , nasal scissors	73
<b>CARDIFF</b> , nasal specula	312	<b>COTTLE</b> , nasal specula	313
<b>CARDIOPHON</b> , stethoscope	190	<b>COTTLE</b> , nose dressing forceps	52
<b>CARPENTER</b> , tonsil knives	247	<b>COTTLE</b> , osteotomes	349
<b>CARREL</b> , artery forceps	21	<b>COTTLE</b> , rhinoplastic and nasal knives	334
<b>CARROLL</b> , needle holders	104	<b>COTTLE</b> , rhinoplastic instruments	346
<b>CARROLL</b> , needle holders tungsten <b>TUC</b>	109	<b>COTTLE-NEIVERT</b> , delicate hooks	345
<b>CARTER</b> , septum elevator	336	Cotton applicators	154, 156
<b>CASTROVIEJO</b> , blade breakers	100	<b>COUPLAND</b> , suction tubes	158
<b>CASTROVIEJO</b> , micro needle holders tungsten <b>TUC</b>	117	<b>CRAIG</b> , ethmoid and septum forceps	330
<b>CASTROVIEJO</b> , suture forceps	53	<b>CRILE</b> , artery forceps	24
Catheter forceps	171	<b>CRILE</b> , needle holders	107
<b>CHADWICK</b> , eye scissors	77	<b>CRILE-MURRAY</b> , needle holders	104
<b>CHAPUT</b> , seizing forceps	20	<b>CRILE-RANKIN</b> , artery forceps	24
<b>CHEATLE</b> , sterilizing forceps	364	<b>CRILE-WOOD</b> , needle holders	104
Cheek and lip retractors	238, 239	<b>CRILE-WOOD</b> , needle holders tungsten <b>TUC</b>	111
Chest support for mouth gag	236	<b>CRILE-WOOD-BABY</b> , needle holders	104
<b>CHEVALIER-JACKSON</b> , trachea tubes	244	<b>CRURA-NIPPER</b> , micro ear forceps	286
<b>CHILDE</b> , suture forceps	127	Curettes	210-214, 289, 298, 347, 348
Chisels	197-206, 299, 348-352	<b>CUSHING</b> , delicate hooks	137
<b>CHRIS-TROUTMAN</b> , blade breakers	100	<b>CUSHING</b> , dissecting forceps tungsten <b>TUC</b>	57
Cilia forceps	51	<b>CUSHING</b> , dressing and tissue forceps	39
<b>CINELLI</b> , chisels	351	<b>CUSHING-TAYLOR</b> , dissecting forceps tungsten <b>TUC</b>	57
<b>CITELLI</b> , punches	288		
Clamps, bulldog	18, 19	<b>D</b>	
Clamps, tubing	32		
<b>CLAR 55</b> , head lamps	182	<b>DAHMEN</b> , chisels	205
<b>CLAR STANDARD</b> , head lamps	182	<b>DAHMEN</b> , osteotomes	205
<b>CLAUS-HAJEK</b> , sphenoid punches	333	<b>DANDY</b> , scalp flap forceps	28
<b>CLAUS-KILLIAN</b> , gouges	348	<b>DAVIS-BOYLE</b> , mouth gags	233
<b>CLEVELAND</b> , bone cutting forceps	227	<b>DAVIS-MAYER</b> , mouth gags	235
<b>CLEVELAND</b> , bone rongeurs	222	<b>DAVIS-RAGNELL</b> , delicate retractors	141
<b>CLEVELAND-GARDNER</b> , bone cutting forceps	226	<b>DE BAKEY(MAYO-HEGAR-DELICATE)</b> , needle holders <b>TUC</b>	108
Clips, suture	127	<b>DE BAKEY</b> , dissecting forceps tungsten <b>TUC</b>	58
<b>CLOWARD</b> , bone curettes	213	<b>DE BAKEY</b> , grasping forceps	398
<b>COAKLEY</b> , curettes	347	<b>DE BAKEY</b> , non-traumatic tissue forceps	55
<b>COBB</b> , chisels	204	<b>DE BAKEY</b> , suction tubes	157
<b>COLBURN-MILLER</b> , nasal rasps	342	<b>DE LA ROZA</b> , ligature needles	125
<b>COLLER</b> , artery forceps	24	<b>DEAVER</b> , operating scissors	64
<b>COLLIER</b> , needle holders	102	Delicate artery forceps	27
<b>COLLIN</b> , mallets	207	Delicate hooks	135-141, 344, 345
<b>COLLIN</b> , scalpel handles	97	Delicate retractors	135-141
<b>COLLIN</b> , suture forceps	126	<b>DENHART</b> , mouth gags	231
<b>COLLIN</b> , tongue holding forceps	240	<b>DERF</b> , needle holders	102
<b>COLLIN-DUVAL</b> , grasping forceps	43	<b>DERF</b> , needle holders tungsten <b>TUC</b>	110
<b>COLLIN-HARTMANN</b> , retractors	146	<b>DERF-CONVERSE</b> , needle holders	102
<b>COLVER</b> , tonsil forceps	252	<b>DERLACKI-SHAMBAUGH</b> , raspatories	298
<b>CONE</b> , retractors	152	Dermatomes	99, 100
Connecting pieces	162	<b>DESMARRES</b> , delicate retractors	141
Connection cords	406, 407	Diagnostic Sets	192, 193
Container 1/1	376-380	Diagnostics	181-194
Container 1/2	368-371	<b>DIEFFENBACH</b> , bulldog clamps	19
Container 3/4	371-375	<b>DIETER</b> , micro ear forceps	287
Container System	365-388	<b>DIETRICH</b> , micro needle holders tungsten <b>TUC</b>	117
Container, endoscopy	385-387	Dilators	241
<b>CONVERSE</b> , chisels	352	<b>DINGMANN</b> , mouth gags	233
<b>CONVERSE</b> , delicate hooks	345	Directors	246
<b>CONVERSE</b> , needle holders tungsten <b>TUC</b>	110	Dissecting, ligature forceps	29
<b>CONVERSE</b> , rhinoplastic instruments	334, 346	Dissecting, scissors	65-72
<b>CONVERSE</b> , rhinoplastic instruments	346	Dissection, micro scissors	80, 82
<b>CONVERSE-DERF</b> , needle holders	102	Dissectors	248-250, 307
<b>CORDES</b> , tips	257	Dissectors, face-lift	218-221
<b>CORWIN</b> , wire twisting forceps tungsten <b>TUC</b>	116	<b>DIXON-LOVELACE</b> , artery forceps	28
<b>COTTLE KAZANJIAN</b> , bone cutting forceps	226	<b>DOLPHIN</b> , blunt/sharp dissection	397, 400
<b>COTTLE(MILLARD)</b> , delicate hooks	345	<b>DOUGHTY-KILNER</b> , mouth gags	232
<b>COTTLE</b> , cartilage crusher	356	<b>DOUGLAS</b> , cilia forceps	51
<b>COTTLE</b> , chisels	349	<b>DOUGLAS</b> , tonsil knives	247
<b>COTTLE</b> , columella forceps	346	<b>DOYEN</b> , needle holders	102
<b>COTTLE</b> , delicate hooks	344, 345	<b>DOYEN</b> , probes	153
<b>COTTLE</b> , elevators	337, 338	<b>DOYEN</b> , tongue depressor	239
<b>COTTLE</b> , mallets	207, 302, 357	<b>DOYEN</b> , towel forceps	30

	Page		Page
<b>DRAFFIN</b> , bipod for mouth gag	236	Fixation forceps	53
Dressing and tissue forceps	34-42	Flexible Nasopharyngoscope	403
<b>DUCKBILL</b> , ear forceps	284	<b>FOERSTER-BALLENGER</b> , sponge holding forceps	133, 134
Ductus salivatory dilators	275	<b>FOMON</b> , chisels	351
Ductus salivatory probes	274	<b>FOMON</b> , delicate hooks	344
<b>DUEHRSSSEN</b> , dressing and tissue forceps	41	<b>FOMON</b> , dissecting scissors	70
<b>DUNHILL</b> , artery forceps	27	<b>FOMON</b> , nasal rasps	341, 343
<b>DUPLAY(VOLTOLINI)</b> , nasal specula	313	<b>FOMON</b> , nasal scissors	73
<b>DUPLAY</b> , polypus forceps	133	<b>FOMON</b> , rhinoplastic and nasal knives	334
<b>DUPLEX</b> , stethoscopes	190	Footplate hand instruments	296, 297
<b>DUPUY WEISS</b> , tonsil needles	251	Forceps, artery	21-28
<b>DURANTE</b> , grasping forceps	44	Forceps, catheter	171
<b>DUVAL</b> , grasping forceps	44	Forceps, cilia	51
<b>DUVAL-COLLIN</b> , grasping forceps	43	Forceps, dissecting and ligature	29
		Forceps, dressing and tissue	34-42
<b>E</b>		Forceps, ear and nose dressing	52
Ear curettes	289, 298, 299	Forceps, fixation	53
Ear dressing forceps	52	Forceps, grasping	43, 44, 397-400
Ear forceps	283, 284	Forceps, hemostatic	15-32
Ear forceps, micro	284-288	Forceps, jeweler's	45
Ear hooklets	290, 292, 293	Forceps, micro	46, 47
Ear knives	291, 294, 295	Forceps, non-traumatic vascular tissue	55
Ear loops	290	Forceps, polypus and dressing	131-134
Ear needles	291-293	Forceps, scalp flap	28
Ear specula	278-281	Forceps, seizing	20, 246
Ear spoons	289	Forceps, setting	19
Ear syringes	306	Forceps, splinter	48-50
easyClean	394-399	Forceps, sponge holding	130-134
<b>ECONOM-UNI</b> , diagnostic sets	192	Forceps, suture	53, 54, 126, 127
<b>EICKEN-KILLIAN</b> , suction tubes	159	Forceps, suture tying with platform	46, 47
Electrode handles	404	Forceps, tissue seizing	17
Electrode handles with fix cable	405	Forceps, towel	30, 31
Electrodes	408, 409	Forceps, tungsten <b>TUC</b>	56-58
Elevators	216, 217, 298, 299	Forceps, wire twisting tungsten <b>TUC</b>	116
Endolaryngeal micro-surgery	259-266	<b>FOREGGER(WISCONSIN)</b> , fibre optic laryngoscopes	168
Endoscopes	401, 402	<b>FOREGGER(WISCONSIN)</b> , laryngoscopes	164
Endoscopy	399-413	<b>FOX</b> , bone curettes	212
<b>ENGL.MODELL</b> , towel forceps	30	<b>FOX-GOLDMAN</b> , scissors tungsten <b>TUC</b>	93
Epiglottis retractor	272	<b>FRAENKEL</b> , laryngeal polypus forceps	272, 273
<b>ERBE (U.S.)</b> , electrode handles with fix cable	405	<b>FRAENKEL</b> , tips	257
<b>ERBE</b> , connection cords	406	<b>FRAZIER</b> , delicate hooks	135
<b>ERBE</b> , electrode handles	404	<b>FRAZIER</b> , suction tubes	159
<b>ERBE/SELECT</b> , connection cords	406	<b>FREEMAN-GORNEY</b> , facelift scissors	69
Ethmoid and septum forceps	330	<b>FREER</b> , aspirating elevator	335
<b>EUFRATE PASQUE</b> , microvascular needle holders <b>TUC</b>	109	<b>FREER</b> , chisels	348
<b>EVES</b> , tonsil snares	254	<b>FREER</b> , delicate hooks	344
<b>EWALD</b> , dressing and tissue forceps	37	<b>FREER</b> , elevators	217, 337
		<b>FREER</b> , gouges	348
<b>F</b>		<b>FREER</b> , rhinoplastic instruments	334
Face-lift dissectors	218-221	<b>FRENCH-EYE/Ryder</b> , needle holders tungsten <b>TUC</b>	108
Facelift marker	188	<b>FRENCH-HARTMANN</b> , tuning forks	303
Facelift scissors	69	<b>FRENZEL</b> , tongue depressors	239
<b>FARABEUF</b> , retractors	147	<b>FRIEDMAN</b> , bone rongeurs	222
<b>FARRELL</b> , cotton applicators	154	Frontal sinus dilators	335
<b>FARRIOR</b> , ear specula	279	Frontal sinus punch forceps	317
<b>FAULKNER</b> , curettes	347	<b>FULLER</b> , micro ear forceps	287
<b>FEILCHENFELD</b> , splinter forceps	48		
<b>FEIN</b> , cotton applicators	155	<b>G</b>	
<b>FERGUSSON</b> , suction tubes	159	<b>GALLAGHER</b> , nasal rasps	340
<b>FERREIRA</b> , retractors	148	<b>GARDNER-CLEVELAND</b> , bone cutting forceps	226
<b>FERRIS-SMITH</b> , sphenoid punches	333	<b>GELFOAM-HOUSE</b> , pressure forceps	307
<b>FERRIS-SMITH</b> , tissue forceps	42	<b>GEMINI</b> , dissecting and ligature forceps	29
Fibre optic cable	411	<b>GERALD</b> , dissecting and tissue forceps	39
Fibre optic laryngoscopes	167-170, 178	<b>GILLIES</b> , delicate hooks	135
Fine scissors	74-77	<b>GILLIES</b> , dissecting forceps tungsten <b>TUC</b>	56
Finger protectors	230	<b>GILLIES</b> , needle holders	106
<b>FINSEN</b> , retractors	149	<b>GILLIES</b> , needle holders tungsten <b>TUC</b>	113
<b>FISCH</b> , dissectors	295	<b>GILLIES</b> , tissue forceps	43
<b>FISCH</b> , footplate hook	297	<b>GLASSMANN</b> , grasping forceps	398
<b>FISCHER</b> , tonsil knives	247	Goitre enucleation scissors	73
		Goitre seizing forceps	246



<b>GOLDMAN-FOX</b> , scissors tungsten <b>TUC</b>	93	Hemostats	15-32
<b>GOLDMANN</b> , rhinoplastic instruments	355	<b>HENKE</b> , dissectors	248
<b>GOLDSMITH (THUDICHUM)</b> , nasal specula	313	<b>HENKE-SASS/WOLF</b> , adapter	412
<b>GOOD</b> , tonsil scissors	72	<b>HENLEY</b> , retractors	150
<b>GOOD-SCHWECKENDICK</b> , tonsil scissors	72	<b>HERBERHOLD</b> , mouth gags	235
<b>GORNEY</b> , aspirating elevator	335	<b>HESSBERG</b> , ligature needles	125
<b>GORNEY</b> , dissecting scissors	70	<b>HEYMANN</b> , ethmoid and septum forceps	330
<b>GORNEY-FREEMAN</b> , facelift scissors	69	<b>HEYMANN</b> , nasal scissors	73
Gouges	197-206, 299, 348	<b>HEYMANN-KNIGHT</b> , nasal polypus forceps	315
Graduated Measures	360	<b>HF-Instruments and accessories</b>	407-410
<b>GRAEFE</b> , delicate hooks	136	<b>HIBBS SPRATT</b> , bone curettes	213
Grasping forceps	43, 44, 397-400	<b>HIBBS</b> , chisels	200
<b>GRAZIL</b> , operating scissors	63	<b>HIBBS</b> , osteotomes	200
<b>GREEN-SENN</b> , delicate retractors	140	<b>HILGER</b> , mouth mirrors	269
<b>GROSS</b> , ear hooklets	290	<b>HOEN</b> , elevators	217
<b>GROSS-MAIER</b> , polypus forceps	131, 132	<b>HOFFMANN-HARTMANN</b> , ear forceps	284
<b>GRUBER</b> , ear specula	278	<b>HOKE</b> , osteotomes	197
<b>GRUENWALD (JANSEN)</b> , nasal forceps	52	<b>HOLINGER</b> , laryngoscopes	178
<b>GUEDEL</b> , trachea tubes	244	Hooklets	290
<b>GULEN</b> , irrigating cannulas	335	Hooks, delicate	135-141, 344, 345
<b>GUTHRIE</b> , delicate hooks	139	<b>HOPKINS-JOHNS</b> , bulldog clamps	19
<b>GWYNNE</b> , dissectors	250	<b>HOPKINS-JOHNS</b> , setting forceps	19
<b>H</b>		<b>HORNE-JOBSON</b> , cotton applicators	155
<b>HAJEK</b> , mallets	302	<b>HOSPITAL-PROVIDENCE</b> , artery forceps	23
<b>HAJEK-CLAUS</b> , sphenoid punches	333	<b>HOUSE</b> , footplate hand instruments	296
<b>HAJEK-KOFFLER</b> , sphenoid punches	332	<b>HOUSE</b> , micro instruments	295
<b>HALLE</b> , elevators	337	<b>HOUSE</b> , suction tubes	300
<b>HALLE</b> , nasal scissors	337	<b>HOUSE-GELFOAM</b> , pressure forceps	307
<b>HALLE</b> , sharp curettes	348	<b>HOWARTH</b> , elevators	338
<b>HALLE-HARTMANN</b> , nasal specula	311	<b>HUBER</b> , universal handle	256
<b>HALLE-RITTER</b> , frontal sinus dilators	335	<b>HUMBY</b> , dermatome	99
<b>HALLE-TIECK</b> , nasal specula	311	<b>HUMBY</b> , rhinoplastic instruments	346
<b>HALSEY</b> , needle holders	103	<b>HUNTER</b> , grasping forceps	399
<b>HALSEY</b> , needle holders tungsten <b>TUC</b>	110	<b>HUNTER</b> , splinter forceps	48
<b>HALSTED</b> , artery forceps	22	<b>HUPP</b> , trachea retractors	243
<b>HALSTED-MOSQUITO</b> , artery forceps	22	<b>HURD</b> , dissectors	248
Handles, easyClean	394, 395	<b>I</b>	
<b>HARMS</b> , suture forceps	54	Incision scissors	64
<b>HARRISON (PYE-SMITH)</b> , sterilizing forceps	364	Inserts, easyClean	396-399
<b>HARTMANN</b> , artery forceps	21	Instrument boxes	363
<b>HARTMANN</b> , bone rongeurs	223	Instrument Storing Tray	374
<b>HARTMANN</b> , ear catheter	302	Iris scissors	76
<b>HARTMANN</b> , ear forceps	283, 284	Irrigating cannulas	335
<b>HARTMANN</b> , ear hooklets	290	<b>ITERSON</b> , trachea retractors	242
<b>HARTMANN</b> , ear specula	278	<b>J</b>	
<b>HARTMANN</b> , nasal cutting forceps	328	<b>JACKSON</b> , fibre optic laryngoscopes	178
<b>HARTMANN</b> , nasal polypus forceps	315	<b>JACKSON</b> , trachea retractors	243
<b>HARTMANN</b> , nasal specula	311	<b>JACKSON-CHEVALIER</b> , trachea tubes	244
<b>HARTMANN</b> , tongue depressors	238	<b>JACOBI</b> , ligature needles	125
<b>HARTMANN</b> , tonsil punches	255	<b>JACOBSON</b> , needle holders tungsten <b>TUC</b>	109
<b>HARTMANN</b> , tuning forks	303	<b>JALASVIRTA</b> , ear dressing forceps	52
<b>HARTMANN-COLLIN</b> , retractors	146	<b>JANET</b> , syringes	161
<b>HARTMANN-FRENCH</b> , tuning forks	303	<b>JANSEN (GRUENDWALD)</b> , nasal forceps	52
<b>HARTMANN-HALLE</b> , nasal specula	311	<b>JANSEN</b> , bone curettes	214
<b>HARTMANN-HOFFMANN</b> , ear forceps	284	<b>JANSEN</b> , ear spoons	289
<b>HARTMANN-NOYES</b> , ear forceps	284	<b>JANSEN</b> , elevators	299
<b>HARTMANN-WULLSTEIN</b> , ear forceps	284	<b>JANSEN</b> , nose dressing forceps	52
Head lamps	181-185	<b>JANSEN</b> , self-retaining retractors	149
Head mirrors	181, 183	<b>JANSEN-MIDDLETON</b> , nasal cutting forceps	329
<b>HEATH-RICHTER</b> , suture forceps	126	<b>JANSEN-ZAUFAL</b> , bone rongeurs	225
<b>HEERMANN</b> , footplate hand instruments	297	Jars	363
<b>HEGAR-MAYO</b> , needle holders	105	<b>JATHO</b> , nasal forceps	331
<b>HEGAR-MAYO</b> , needle holders tungsten <b>TUC</b>	108	<b>JENNINGS</b> , mouth gags	231
<b>HEGAR-MAYO-DELICATE(DE BAKEY)</b> , needle holders <b>TUC</b>	108	<b>JEWELER</b> , dissecting forceps tungsten <b>TUC</b>	56
<b>HEGAR-MAYO-DELICATE</b> , needle holders	105	Jeweler's forceps	45
<b>HEGAR-OLSEN</b> , needle holders	106	<b>JOBSON-HORNE</b> , cotton applicators	155
<b>HEGAR-OLSEN</b> , needle holders tungsten <b>TUC</b>	113	<b>JOHNS-HOPKINS</b> , bulldog clamps	19
<b>HEGENBARTH</b> , suture forceps	126	<b>JOHNS-HOPKINS</b> , setting forceps	19
<b>HEISTER</b> , mouth gags	230		
Hemostatic forceps	15-32		



	Page		Page
<b>JONES</b> , towel forceps	30	<b>LANGE</b> , suture forceps	127
<b>JOSEPH</b> , delicate hooks	139, 344	<b>LANGE</b> , tips	257
<b>JOSEPH</b> , dissecting scissors	71	<b>LANGENBECK</b> , ear curettes	289
<b>JOSEPH</b> , elevators	337	<b>LANGENBECK</b> , elevators	216
<b>JOSEPH</b> , nasal rasps	340	<b>LANGENBECK</b> , finger protectors	230
<b>JOSEPH</b> , rhinoplastic and nasal knives	334	<b>LANGENBECK</b> , needle holders	107
<b>JOSEPH</b> , rhinoplastic instruments	339, 356	<b>LANGENBECK</b> , needle holders tungsten <b>TUC</b>	116
<b>JOSEPH-MASING</b> , elevators	337	<b>LANGENBECK</b> , raspatories	215
<b>K</b>		<b>LANGENBECK-DELICATE</b> , needle holders tungsten <b>TUC</b>	116
<b>KABIERSKE</b> , powder blower	305	<b>LANGENBECK-KOCHER</b> , retractors	143
<b>KALT</b> , micro needle holders tungsten <b>TUC</b>	117	<b>LANGENBECK-MINI</b> , delicate retractors	140
<b>KAYE</b> , face-lift-scissors <b>TUC</b>	93	<b>LANGENBECK-RYDER</b> , needle holders tungsten <b>TUC</b>	116
<b>KAZANJIAN</b> , nasal forceps	331	<b>LANGE-WILDE</b> , polypus snares	282, 314
<b>KELLY (RICHARDSON)</b> , retractors	145	<b>LARKIN</b> , footplate hand instruments	296
<b>KELLY</b> , artery forceps	24	Laryngeal forceps	272
<b>KELLY-RANKIN</b> , artery forceps	24	Laryngeal mirrors	271
<b>KELMAN-McPHERSON</b> , suture forceps	53	Laryngeal polypus forceps	273
<b>KERRISON</b> , sphenoid punches	332	Laryngo-bronchoscopy forceps	267
Kidney bowls	360	Laryngoscopes	163-166
<b>KILLIAN</b> , elevators	338	Laryngoscopes, fibre optic	167-170, 178
<b>KILLIAN</b> , gouges	348	Laryngoscopes, operating	172-180
<b>KILLIAN</b> , nasal polypus forceps	315	<b>LEMPERT</b> , bone rongeurs	224
<b>KILLIAN</b> , nasal specula	312	<b>LEMPERT</b> , curettes	298
<b>KILLIAN</b> , septum scissors	272	<b>LEMPERT</b> , elevators	298
<b>KILLIAN-CLAUS</b> , gouges	348	<b>LEMPERT</b> , raspatories	298
<b>KILLIAN-EICKEN</b> , suction tubes	159	<b>LERICHE</b> , artery forceps	23
<b>KILNER (RAGNELL)</b> , scissors	71	<b>LEWIS</b> , nasal rasps	340, 343
<b>KILNER</b> , delicate hooks	135, 345	<b>LEXER</b> , chisels	202, 203
<b>KILNER</b> , needle holders	103	<b>LEXER</b> , osteotomes	202, 203
<b>KILNER</b> , needle holders tungsten <b>TUC</b>	110	<b>LEXER</b> , scissors	70
<b>KILNER-DOUGHTY</b> , mouth gags	232	<b>LEXER</b> , scissors tungsten <b>TUC</b>	90
<b>KLEINERT-KUTZ</b> , bone rongeurs	225	<b>LEXER-BABY</b> , scissors	71
<b>KLEINERT-KUTZ</b> , delicate hooks	135	<b>LEXER-MINI</b> , chisels	202
<b>KLINIKUM BERLIN</b> , tubing clamps	32	<b>LEXER-MINI</b> , osteotomes	202
<b>KNAPP</b> , delicate hooks	139	<b>LICHTENBERG</b> , needle holders tungsten <b>TUC</b>	115
<b>KNIGHT</b> , ethmoid and septum forceps	330	<b>LICHTWITZ</b> , trocars	156
<b>KNIGHT-HEYMANN</b> , nasal polypus forceps	315	Ligature and dissecting forceps	29
Knives	291, 334, 347	Ligature, scissors	77, 78
Knives, tonsil	247	Lip and cheek retractors	238, 239
<b>KOCHER</b> , directors	246	<b>LISTER</b> , dressing forceps	130
<b>KOCHER</b> , retractors	142, 144	<b>LISTER</b> , scissors tungsten <b>TUC</b>	93
<b>KOCHER-DELICATE</b> , artery forceps	27	<b>LISTON</b> , bone cutting forceps	226
<b>KOCHER-LANGENBECK</b> , retractors	143	<b>LISTON-RUSKIN</b> , bone cutting forceps	227
<b>KOCHER-OCHSNER</b> , artery forceps	26	<b>LISTON-WALTON</b> , bone cutting forceps	227
<b>KOFFLER-HAJEK</b> , sphenoid punches	332	<b>LITTAUER</b> , cilia forceps	51
<b>KRAUSE</b> , polypus snares	282, 314	<b>LITTAUER</b> , ligature scissors	77
<b>KRAUSE</b> , tips	257	<b>LITTAUER-LISTON</b> , bone cutting forceps	226
<b>KRAUSE-VOSS</b> , polypus snares	282, 314	<b>LITTLE</b> , retractors	144
<b>KRESSNER</b> , rhinoplastic instruments	355	<b>LITTLER</b> , fine scissors	75
<b>KROENIG</b> , tongue depressors	239	<b>LOCKHART-MUMMERY</b> , probes	154
<b>KROENLEIN</b> , seizing forceps	20	Loops	290
<b>KRONECKER</b> , ligature needles	125	<b>LOPEZ-REINKE</b> , dissectors	249
<b>KRONE-MARSCHIK</b> , tonsil forceps	252	<b>LORNA</b> , towel forceps	31
<b>KUHN-BOLGER</b> , sharp curettes	347	<b>LOVELACE-DIXON</b> , artery forceps	28
<b>KUTZ-KLEINERT</b> , bone rongeurs	225	<b>LUBET-BARBON</b> , nasal polypus forceps	315
<b>KUTZ-KLEINERT</b> , delicate hooks	135	<b>LUC</b> , ethmoid and septum forceps	330
<b>L</b>		<b>LUCAE</b> , ear hooklets	290
<b>LA FORCE</b> , adenotomes	354	<b>LUCAE</b> , mallets	208
<b>LABORDE</b> , dilators	241	<b>LUCAE</b> , nose dressing forceps	52
<b>LACK</b> , tongue depressor	238	<b>LUCAE</b> , paracentesis needles	291
<b>LAHEY</b> , goitre seizing forceps	246	<b>LUCAE</b> , tuning forks	303
<b>LAHEY</b> , retractors	144	<b>LUCAS</b> , chisels	197
<b>LAMBOTTE</b> , osteotomes	206	<b>LUER</b> , bone rongeurs	223
<b>LAMBOTTE-MINI</b> , osteotomes	206	<b>LUER</b> , trachea retractors	243
<b>LANE</b> , tissue forceps	38	<b>LUER</b> , trachea tubes	244
<b>LANE</b> , towel forceps	30	<b>LUKENS</b> , trachea retractors	242
<b>LANGE</b> , delicate hooks	344	<b>LUNIATSCHECK</b> , dissectors	249
<b>LANGE</b> , laryngeal polypus forceps	273	<b>M</b>	
		<b>MACKAY</b> , sharp curettes	347
		<b>MACKAY</b> , sickle knife	347



<b>MAGILL</b> , catheter forceps	171	Micro forceps	46, 47
<b>MAIER-GROSS</b> , polypus forceps	131, 132	Micro instruments	295
Mallets	207-209, 302, 357	Micro needle holders	117-123
<b>MALTZ</b> , nasal rasps	340	Micro needle holders with pen-type handle	118-122
<b>MARLIN</b> , suture material	250	Micro scissors	79-84
<b>MARQUARDT</b> , bone rongeurs	224	<b>MICRO WULLSTEIN</b> , suction tubes	159
<b>MARSCHIK</b> , tonsil forceps	250	<b>MICRO-ADSON</b> , dressing and tissue forceps	36
<b>MARSCHIK-KRONE</b> , tonsil forceps	252	<b>MICRO-MOSQUITO</b> , artery forceps	22
<b>MARTEL</b> , scalp flap forceps	20	Micro-Needle holders	117-123
<b>MARTIN</b> , nasal specula	312	<b>MICRO-RYDER</b> , needle holders tungsten <b>TUC</b>	108
<b>MARTIN/BERCHTOLD</b> , connection cords	406	<b>MICROVASCULAR EUFRATE PASQUE</b> , needle holders <b>TUC</b>	109
<b>MARTIN/BERCHTOLD</b> , electrode handles	404	<b>MIDDELDORPF</b> , retractors	145
<b>MARTIN/BERCHTOLD</b> , electrode handles with fix cable	405	<b>MIDDLETON-JANSEN</b> , nasal cutting forceps	329
<b>MARTINI</b> , bone curettes	214	<b>MILLARD(COTTLE)</b> , delicate hooks	345
<b>MARYLAND</b> , blunt dissection	397	<b>MILLER</b> , fibre optic laryngoscopes	169
<b>MASING</b> , chisels	352	<b>MILLER</b> , laryngoscopes	165
<b>MASING</b> , delicate hooks	345	<b>MILLER-COLBURN</b> , nasal rasps	342
<b>MASING</b> , elevators	338	<b>MILLER-SENN</b> , delicate retractors	141
<b>MASING</b> , nasal rasps	341	<b>MILLER-SENN-BABY</b> , delicate retractors	141
<b>MASING</b> , rhinoplastic and nasal knives	334	<b>MILLIGAN</b> , retractors	151
<b>MASING-JOSEPH</b> , elevators	337	<b>MINI</b> , scalpel handles	98
<b>MASS.-GENERAL-HOSPITAL</b> , needle holders	105	<b>MINI-FRIEDMAN</b> , bone rongeurs	222
<b>MASTIN</b> , muscular clamp	246	<b>MINI-LAMBOTTE</b> , osteotomes	206
<b>MATHIEU</b> , needle holders	106	<b>MINI-LANGENBECK</b> , delicate retractors	140
<b>MATHIEU</b> , needle holders tungsten <b>TUC</b>	113	<b>MINI-LEXER</b> , chisels	202
<b>MATHIEU-DELICATE</b> , needle holders	106	<b>MINI-LEXER</b> , osteotomes	202
<b>MATHIEU-DELICATE</b> , needle holders tungsten <b>TUC</b>	114	<b>MINI-RUSKIN</b> , bone rongeurs	225
<b>MATHIEU-RYDER VASCULAR</b> , needle holders tungsten <b>TUC</b>	114	Mirrors, laryngeal	271
<b>MATHIEU-RYDER</b> , needle holders tungsten <b>TUC</b>	114	Mirrors, mouth	269, 270
<b>MAUNDER</b> , oral wedge	230	Mirrors, post-rhinoscopic	272
<b>MAYER-DAVIS</b> , mouth gags	235	<b>MIXTER</b> , operating scissors	64
<b>MAYFIELD</b> , bone rongeurs	224	<b>MIXTER-BABY</b> , dissecting and ligature forceps	29
<b>MAYO</b> , safety pins	364	<b>MIXTER-O'SHAUGNESSY</b> , dissecting and ligature forceps	29
<b>MAYO</b> , scissors	65	<b>MOD. BONN</b> , fine scissors	76
<b>MAYO</b> , scissors tungsten <b>TUC</b>	87	<b>MOD. BONN</b> , suture forceps	54
<b>MAYO</b> , tongue depressors	239	<b>MOD.TÜBINGEN</b> , suture forceps	54
<b>MAYO-HEGAR</b> , needle holders	105	<b>MOD.USA</b> , dressing and tissue forceps	36
<b>MAYO-HEGAR</b> , needle holders tungsten <b>TUC</b>	108	<b>MOD.WIEN</b> , nasal specula	312
<b>MAYO-HEGAR-DELICATE(DE BAKEY)</b> , needle holders <b>TUC</b>	108	<b>MOD.WÜRZBURG</b> , mouth gags	234
<b>MAYO-HEGAR-DELICATE</b> , needle holders	105	<b>MOLDESTAD</b> , delicate hooks	137
<b>MAYO-STILLE</b> , scissors	65	<b>MOLLISON</b> , dissectors	249
<b>MAYO-STILLE</b> , scissors tungsten <b>TUC</b>	88	<b>MOLLISON</b> , retractors	151
<b>MC INDOE</b> , bone cutting forceps	227	<b>MOLT</b> , mouth gags	230
<b>MC INDOE</b> , dressing forceps	37	<b>MORITZ-SCHMIDT</b> , tongue depressors	238
<b>MC INDOE</b> , rhinoplastic instruments	346	<b>MOSHER-WAGENER</b> , tubes	243
<b>MC INTOSH</b> , fibre optic laryngoscopes	167	<b>MOSQUITO-HALSTED</b> , artery forceps	22
<b>MC INTOSH</b> , laryngoscopes	163	<b>MOSQUITO-MICRO</b> , artery forceps	22
<b>MC IVOR</b> , mouth gags	234	Mouth gags	230-236
<b>MCDONALD</b> , elevators	217	Mouth mirror handles	268
<b>MCGEE</b> , ear hooklets	293	Mouth mirrors	269, 270
<b>MCGEE</b> , micro ear forceps	286	<b>MUCK</b> , knives	299
<b>MCKENTY</b> , elevators	337	<b>MULDOON</b> , ductus salivatory dilators	275
<b>MCKERNAN</b> , grasping forceps	399	<b>MUMMERY-LOCKHART</b> , probes	154
<b>MCKESSON</b> , oral wedges	237	<b>MURRAY-CRILE</b> , needle holders	104
<b>MCPHERSON</b> , suture forceps	53	Muscular clamp	246
<b>MCPHERSON-KELMAN</b> , suture forceps	53	<b>MUSEUX</b> , tonsil forceps	252
<b>MEAD</b> , bone rongeurs	223	<b>MYLES</b> , irrigating cannulas	335
<b>MEAD</b> , mallets	208	<b>MYRTLE LEAF</b> , probes	153
Metal comb	364		
<b>METZENBAUM</b> , endoscopy scissors	396, 400	<b>N</b>	
<b>METZENBAUM</b> , needle holders tungsten <b>TUC</b>	114	<b>NAGER</b> , tonsil retractor	251
<b>METZENBAUM</b> , scissors	65, 66	Nasal and tonsil scissors	72, 73
<b>METZENBAUM</b> , scissors tungsten <b>TUC</b>	88, 89	Nasal cutting forceps	327-329
<b>METZENBAUM-BABY</b> , scissors	66	Nasal polypus forceps	315
<b>METZENBAUM-DELICATE</b> , scissors	68	Nasal rasps	340-343
<b>METZENBAUM-DELICATE</b> , scissors tungsten <b>TUC</b>	90, 91	Nasal snares	314
<b>METZENBAUM-NELSON</b> , scissors	67	Nasal specula	311-313
<b>MEYERDING</b> , delicate retractors	140	Nasopharyngeal speculum	312
<b>MICHEL</b> , laryngeal mirrors	271	Needle holders	102-116
<b>MICHEL</b> , suture clips	127	Needle holders, endoscopy	397
<b>MICHEL</b> , suture forceps	126	Needle holders, micro	117-123
Micro ear forceps	285-288		

	Page		Page
Needle holders, micro tungsten <b>TUC</b>	117-119	<b>PLESTER</b> , micro instruments	295
Needle holders, tungsten <b>TUC</b>	108-119	<b>PLESTER</b> , retractors	152
Needle Sterilizing Cases	361	<b>PLESTER</b> , suction tubes	159
Needles, reverdin	124	<b>POLITZER</b> , air bag	305
Needles, special	156-162	<b>POLITZER</b> , ear specula	278
<b>NEGUS(BECKMANN)</b> , adenoid currettes	353	<b>POLITZER</b> , knives	291
<b>NEGUS</b> , aspirating elevator	335	<b>POLITZER</b> , paracentesis needles	291
<b>NEGUS</b> , chest support for mouth gag	236	Polypus and dressing forceps	131-134
<b>NEIVERT</b> , needle holders	103	Polypus snares	282, 314
<b>NEIVERT</b> , needle holders tungsten <b>TUC</b>	110	<b>POOLE</b> , suction tubes	158
<b>NEIVERT</b> , osteotomes	352	<b>POOLE-BABY</b> , suction tubes	158
<b>NEIVERT-ANDERSON</b> , osteotomes	352	<b>POTTS-SMITH</b> , dissecting forceps tungsten <b>TUC</b>	56
<b>NEIVERT-COTTLE</b> , delicate hooks	345	<b>POTTS-SMITH</b> , dressing and tissue forceps	40
<b>NELATON</b> , probes	153	Powder blower	305
<b>NELSON-METZENBAUM</b> , scissors	67	<b>PRATT</b> , fistula probe	154
<b>NEW ORLEANS</b> , needle holders tungsten <b>TUC</b>	109	<b>PRATT</b> , sharp currettes	347
<b>NEWS</b> , trachea retractors	243	<b>PRECISA</b> , blood pressure manometers	191
<b>NIJMEGEN</b> , suction tubes	159	<b>PRESBYTERIAN</b> , tubing clamps	32
<b>NOLST-TRENITÉ JOSEPH</b> , rhinoplastic instruments	339	Pressure forceps	307
<b>NOLST-TRENITÉ</b> , osteotomes	350	<b>PRINCE</b> , tonsil scissors	72
Non-traumatic vascular tissue forceps	55	Probes	153-155, 274
<b>NORTHBENT</b> , ligature scissors	78	<b>PROVIDENCE-HOSPITAL</b> , artery forceps	23
Nose dressing forceps	52	Punches	288, 320, 321, 332, 333
<b>NOYES-HARTMANN</b> , ear forceps	284	Punches, endoscopy	396
Nystagmus spectacles	186, 187	Puncture	156-162
<b>O</b>		<b>PYE-SMITH (HARRISON)</b> , sterilizing forceps	364
<b>O'BRIAN</b> , fine scissors	76	<b>PYNCHON-ANDREWS</b> , suction tubes	157
<b>O'CONNOR</b> , delicate hooks	136	<b>Q</b>	
<b>O'SHAUGNESSY-MIXTER</b> , dissecting and ligature forceps	29	<b>QUIRE</b> , ear forceps	283
<b>OBWEGESER</b> , osteotomes	352	<b>R</b>	
<b>OBWEGESER</b> , retractors	143	<b>RAGNELL (KILNER)</b> , scissors	71
<b>OCHSNER-KOCHER</b> , artery forceps	26	<b>RAGNELL-DAVIS</b> , delicate retractors	141
<b>OEHLER</b> , dissecting forceps tungsten <b>TUC</b>	56	<b>RALK</b> , splinter forceps	50
<b>OLSEN-HEGAR</b> , needle holders	106	<b>RAMPLEY</b> , sponge holding forceps	134
<b>OLSEN-HEGAR</b> , needle holders tungsten <b>TUC</b>	113	<b>RANKIN-CRILE</b> , artery forceps	24
<b>OLYMPUS</b> , adapter	412	<b>RANKIN-KELLY</b> , artery forceps	24
Operating laryngoscopes	172-180	Raspatories	215, 216, 298
Optical retractor	148	Razor Blades	100
Oral wedges	230, 237	<b>REICHERT</b> , epiglottis retractor	272
Orthopaedic	195-228	<b>REILL</b> , micro needle holders	120
Osteotomes	197-206, 299, 349-352	<b>REINKE-LOPEZ</b> , dissectors	249
Oto-/ophthalmoscope	193	Reposition forceps	228
Otoscope, video	194	Retractor with fibre optic illumination	148
<b>OTOSKOP UNI</b> , diagnostic set	193	Retractors	135-152, 240, 241, 358
<b>P</b>		Retractors, delicate	135-141
Palate arch retractor	237	Retractors, self-retaining	149-152
Paracentesis needles	291	<b>REVERDIN</b> , needles	124
<b>PARKER</b> , retractors	147	<b>REYNOLDS</b> , scissors	72
<b>PARTSCH</b> , chisels	198	Rhinoplastic and nasal knives	334
<b>PARTSCH</b> , mallets	208	Rhinoplastic instruments	339, 346, 356
<b>PASSOW</b> , chisels	299	<b>RICHARDSON(KELLY)</b> , retractors	145
<b>PAUFIQUE</b> , suture forceps	54	<b>RICHTER</b> , operating scissors	64
<b>PAULSEN</b> , irrigating cannulas	335	<b>RICHTER-HEATH</b> , suture forceps	126
<b>PEAN</b> , seizing forceps	20	<b>RING</b> , mouth gags	234
<b>PEAN-DELICATE</b> , artery forceps	27	<b>RIRAP</b> , stethoscopes	189
<b>PEAN-ROCHESTER</b> , artery forceps	25	<b>RITTER-HALLE</b> , frontal sinus dilators	335
<b>PEERS</b> , towel forceps	31	<b>ROCHESTER-PEAN</b> , artery forceps	25
<b>PEET</b> , splinter forceps	50	<b>RÖDER</b> , tonsil ligating instruments	250
<b>PENNINGTON</b> , rhinoplastic instruments	339	<b>ROEDER</b> , towel forceps	31
<b>PENNINGTON</b> , seizing forceps	20	<b>ROGER</b> , septum elevator	336
<b>PERWITZSCHKY</b> , fine scissors	74, 275	<b>ROGGE</b> , sterilizing forceps	364
<b>PETERSEN-SMITH</b> , chisels	199	<b>ROLLET</b> , delicate hooks	139
<b>PETERSEN-SMITH</b> , osteotomes	199	<b>ROSE</b> , trachea retractors	243
<b>PIERCE</b> , rhinoplastic instruments	339	<b>ROSEN</b> , ear needles	292, 293
<b>PIFFARD</b> , bone currettes	212	<b>ROSEN</b> , knives	294
<b>PILCHER</b> , nasal specula	312	<b>ROSEN</b> , micro instruments	295
<b>PITHA</b> , oral wedge	230	<b>ROSER-KÖNIG</b> , mouth gags	231
<b>PLESTER</b> , knives	294	<b>ROUX</b> , retractors	146



<b>ROWE</b> , reposition forceps	228	Septum and periosteal elevators	336-338
<b>RUBIN</b> , osteotomes	351	Septum knives	336
<b>RUBIN</b> , rhinoplastic instruments	356	Septum needle	335
<b>RUSKIN</b> , bone rongeurs	225	Septum straightening forceps	355
<b>RUSKIN-LISTON</b> , bone cutting forceps	227	<b>SEPTUM</b> , septum needle	335
<b>RUSKIN-MINI</b> , bone rongeurs	225	Setting forceps	19
<b>RUSS.MODELL</b> , grasping forceps	44	<b>SEWALL</b> , curettes	347
<b>RYDER/FRENCH EYE</b> , needle holders tungsten <b>TUC</b>	108	<b>SHAMBAUGH</b> , ear hooklets	292
<b>RYDER-LANGENBECK</b> , needle holders tungsten <b>TUC</b>	116	<b>SHAMBAUGH-DERLACKI</b> , raspatories	298
<b>RYDER-MATHIEU VASCULAR</b> , needle holders tungsten <b>TUC</b>	114	<b>SHAPLEIGH</b> , ear curettes	289
<b>RYDER-MATHIEU</b> , needle holders tungsten <b>TUC</b>	114	Sharp dissection	396, 400
<b>RYDER-MICRO</b> , needle holders tungsten <b>TUC</b>	108	<b>SHEA</b> , footplate hand instruments	296
<b>S</b>		<b>SHEEHAN</b> , osteotomes	351
Safety pins	364	<b>SHORTBENT</b> , ligature scissors	78
<b>SANVENERO</b> , scissors	71	<b>SIEGLE</b> , ear specula	281
<b>SAROT</b> , needle holders	104	<b>SILVER</b> , dermatomes	100
<b>SAROT</b> , needle holders tungsten <b>TUC</b>	111	<b>SILVER</b> , osteotomes	352
<b>SAUERBRUCH</b> , retractors	144	<b>SIMPLEX</b> , cheek retractors	238
Scalp flap forceps	28	Sinuscopy forceps and scissors	318-327
<b>SCALP-CONTOUR</b> , retractors	152	<b>SINUSCOPY</b> , trocars	156
Scalpel, handles	96-98	<b>SLUDER-BALLENGER</b> , tonsillectome	253
<b>SCHAEDEL</b> , towel forceps	30	<b>SMITH-FERRIS</b> , sphenoid punches	333
<b>SCHÄFER</b> , retractors	358	<b>SMITH-FERRIS</b> , tissue forceps	42
<b>SCHEDE</b> , bone curettes	211	<b>SMITH-PETERSEN</b> , chisels	199
<b>SCHEINMANN</b> , tips	257	<b>SMITH-PETERSEN</b> , osteotomes	199
<b>SCHINK</b> , dermatomes	99	<b>SMITH-POTTS</b> , dissecting forceps tungsten <b>TUC</b>	56
<b>SCHMEDEN</b> , nasal cutting forceps	328	<b>SMITH-POTTS</b> , dressing and tissue forceps	40
<b>SCHMEDEN</b> , tonsil punches	255	<b>SNELLEN</b> , ear loops	290
<b>SCHMIDT-MORITZ</b> , tongue depressors	238	<b>SNITMAN</b> , self-retaining retractors	149
<b>SCHOEMAKER</b> , goitre enucleation scissors	73	Soft palate retractor	237
<b>SCHOENBORN</b> , trachea retractors	242	<b>SONNENSCHIEIN</b> , nasal specula	312
<b>SCHUHKNECHT</b> , bending device for stapedial wire prostheses	297	Special needles	156-162
<b>SCHUKNECHT</b> , knives	294	<b>SPENCER</b> , ligature scissors	77
<b>SCHUHKNECHT</b> , retractors	151	<b>SPENCER-DELICATE</b> , ligature scissors	77
<b>SCHUKNECHT(BARON)</b> , suction tubes	300	<b>SPENCER-WELLS</b> , artery forceps	21
<b>SCHUMACHER</b> , tips	257	Sphenoid punches	332, 333
<b>SCHWECKENDICK-GOOD</b> , tonsil scissors	72	Splinter forceps	48-50
Scissors	59-94	Sponge forceps	130-134
Scissors, dissecting	65-72	Spoons	289, 347, 348
Scissors, endoscopy	396	<b>SPRATT</b> , bone curettes	211
Scissors, fine	74-77	<b>ST.BARTHOLOMEW</b> , nasal forceps	331
Scissors, goitre enucleation	73	<b>ST.CLAIR-THOMPSON</b> , adenoid curettes	354
Scissors, incision	64	<b>ST.CLAIR-THOMPSON</b> , post-rhinoscopic mirror	272
Scissors, iris	76	<b>ST.MARTIN</b> , suture forceps	53
Scissors, ligature	77, 78	<b>STACKE</b> , probes	153
Scissors, micro	79-84	<b>STAMMBERGER</b> , sinuscopy forceps	324
Scissors, micro adventitia	80, 82	<b>STANDARD</b> , dressing and tissue forceps	34
Scissors, micro dissection	80, 82	<b>STANDARD</b> , operating scissors	62
Scissors, nasal	73	<b>STANDARD</b> , scissors tungsten <b>TUC</b>	86, 87
Scissors, nerve dissecting	70	<b>STANDARD</b> , tongue depressors	239
Scissors, operating	62-65	<b>STELLBRINK</b> , bone rongeurs	222
Scissors, super-cut <b>SC</b>	61	Sterilizing forceps	364
Scissors, tenotomy	77, 78	<b>STERNBERG</b> , cheek and lip retractors	238
Scissors, tonsil	72	<b>STERNUM</b> , wire twisting forceps tungsten <b>TUC</b>	116
Scissors, tungsten <b>TUC</b>	85-93	Stethoscopes	189, 190
<b>SEBILEAU</b> , elevators	216	<b>STEVENS</b> , scissors tungsten <b>TUC</b>	92
<b>SECCO</b> , mouth mirror handle	268	<b>STEVENS</b> , tenotomy scissors	77
<b>SEIFFERT</b> , tips	257	<b>STIEGLITZ</b> , splinter forceps	50
Seizing forceps	20, 246	<b>STIERLEN</b> , tongue depressor	241
<b>SELECT/ERBE</b> , connection cords	406	<b>STILLE</b> , chisels	201
Self-retaining retractors	149-152	<b>STILLE</b> , dressing and tissue forceps	42
<b>SEMKEN</b> , dissecting forceps tungsten <b>TUC</b>	56	<b>STILLE</b> , osteotomes	201
<b>SEMKEN</b> , dressing and tissue forceps	37, 38	<b>STILLE-BARRAYA</b> , tissue forceps	42
<b>SENN-GREEN</b> , delicate retractors	140	<b>STILLE-MAYO</b> , scissors	65
<b>SENNING(SWED.MODEL)</b> , needle holders	105	<b>STILLE-MAYO</b> , scissors tungsten <b>TUC</b>	88
<b>SENNING(SWED.MODEL)</b> , needle holders tungsten <b>TUC</b>	109	Stopcocks	162
<b>SENN-MILLER</b> , delicate retractors	141	<b>STORZ</b> , adapter	412
<b>SENN-MILLER-BABY</b> , delicate retractors	141	<b>STRÜMPFEL</b> , ear forceps	284
Sensibility instruments	188	<b>STRUYCKEN</b> , nasal cutting forceps	328, 329
Septum and ethmoid forceps	330	<b>STRUYCKEN</b> , sinuscopy forceps	319
		<b>STRYKER</b> , adapter	412
		Suction tubes	157-160, 300, 301

	Page		Page
<b>SULLIVAN (BROPHY)</b> , fine scissors	75	<b>UNI OTOSKOP</b> , diagnostic set	193
Super Cut Scissors, <b>TUC</b>	85	<b>UNI-ECONOM</b> , diagnostic sets	192
Suture	101-128	<b>UNIV.MINNESOTA</b> , tongue depressors	239
Suture instrument	107	Universal handles and tips	256, 257
Suture tying forceps with platform	46, 47	<b>UNIVERSAL</b> , bone rongeurs	222
Suture, clips	127		
Suture, forceps	53, 54, 126, 127	<b>V</b>	
<b>SWED.MODEL(SENNING)</b> , needle holders	105	<b>VALLEYLAB</b> , connection cords	406
<b>SWED.MODEL(SENNING)</b> , needle holders tungsten <b>TUC</b>	109	<b>VALLEYLAB</b> , electrode handles with fix cable	405
<b>SYME</b> , ligature needles	124	Various items for sterilization	381-388
Syringes	161, 306	Various sizes and accessories	359-364
		<b>VASCULAR MATHIEU-RYDER</b> , needle holders tungsten <b>TUC</b>	114
<b>T</b>		Ventilation tube inserter	307
<b>TABB</b> , knives	294	Ventilation tubes	307
<b>TAKAHASHI</b> , nasal cutting forceps	329	<b>VERHOEVEN</b> , suction tubes	301
<b>TAKAHASHI</b> , sinuscopy forceps	319	Vessel dilators	47
<b>TAYLOR</b> , tissue and dressing forceps	38	Video otoscope	194
<b>TAYLOR-CUSHING</b> , dissecting forceps tungsten <b>TUC</b>	57	<b>WISE</b> , suture tying forceps with platform	46
<b>TERRIER</b> , artery forceps	21	<b>VOLKMANN</b> , bone curettes	210, 214
<b>THIESS</b> , mallets	208	<b>VOLKMANN</b> , retractors	142
<b>THOMPSON-ST.CLAIR</b> , post-rhinoscopic mirror	272	<b>VOLTOLINI(DUPLAY)</b> , nasal specula	313
<b>THOREK</b> , scissors	70	<b>VOSS-KRAUSE</b> , polypus snares	282, 314
<b>THUDICHUM(GOLDSMITH)</b> , nasal specula	313		
<b>TIECK-HALLE</b> , nasal specula	311	<b>W</b>	
<b>TILLEY</b> , ear forceps	283	<b>WACHENFELDT</b> , suture forceps	126
Tissue and dressing forceps	34-42	<b>WAGENER</b> , ear hooklets	290
Tissue seizing forceps	17	<b>WAGENER-MOSHER</b> , tubes	243
<b>TIVNEN</b> , tonsil forceps	252	<b>WAGNER</b> , fine scissors	74
<b>TOBOLD</b> , cotton applicators	238	<b>WALSHAM</b> , septum straightening forceps	355
<b>TOBOLD</b> , tongue depressors	238	<b>WALTER(AUFRICHT)</b> , rhinoplastic instruments	346
<b>TOENNIS</b> , needle holders	107	<b>WALTER</b> , chisels	351
<b>TOENNIS</b> , needle holders tungsten <b>TUC</b>	115	<b>WALTER</b> , delicate retractors	141
<b>TOENNIS-ADSON-DELICATE</b> , scissors tungsten <b>TUC</b>	93	<b>WALTER</b> , osteotomes	351
<b>TOHOKU-JAPAN</b> , towel forceps	31	<b>WALTON</b> , fine scissors	76
Tongue depressors	238, 239	<b>WALTON-LISTON</b> , bone cutting forceps	227
Tongue holding forceps	240, 241	<b>WALTON-YANKAUER</b> , suction tubes	157
Tonsil and nasal scissors	72, 73	<b>WANGENSTEEN</b> , dissecting forceps tungsten <b>TUC</b>	58
Tonsil cannula	253	<b>WARTENBERG</b> , sensibility instruments	188
Tonsil forceps	250, 252	<b>WATSON</b> , dermatome	99
Tonsil knives	247	<b>WATSON-WILLIAMS</b> , nasal cutting forceps	327
Tonsil ligating instruments	250	<b>WAUGH</b> , grasping forceps	43
Tonsil needles	251	<b>WEBSTER</b> , needle holders	103
Tonsil punches	255	<b>WEBSTER</b> , needle holders tungsten <b>TUC</b>	110
Tonsil retractors	251	<b>WEERDA</b> , dilators	241
Tonsil snares	254	<b>WEIL-BLAKESLEY</b> , nasal cutting forceps	327
Tonsillectome	253	<b>WEIL-BLAKESLEY</b> , sinuscopy forceps	318, 319
Towel forceps	30, 31	<b>WEINGÄRTNER</b> , ear forceps	284
<b>TOYNBEE</b> , ear specula	278	<b>WEITLANER</b> , retractors	150
Trachea retractors	242, 243	<b>WEITLANER-BABY</b> , retractors	150
Trachea tubes	244	<b>WELLS-SPENCER</b> , artery forceps	21
Tracheotomy set	245	<b>WEST</b> , chisels	348
<b>TRELAT</b> , periosteal elevator	336	<b>WEST</b> , gouges	348
<b>TREPSAT</b> , facelift scissors	69	<b>WESTMACOTT</b> , nasal polypus forceps	315
Trocar Sleeves and Trocars	393	<b>WHITE</b> , tonsil forceps	252
Trocars	156, 241	<b>WHITEHEAD</b> , mouth gags	232
<b>TROELTSCH(WILDE)</b> , ear dressing forceps	52	<b>WIEDER</b> , tongue depressors	238
<b>TROUSSEAU</b> , dilators	241	<b>WIENER</b> , nasal rasps	341
<b>TROUTMAN-CHRIS</b> , blade breakers	100	<b>WILDE(TROELTSCH)</b> , ear dressing forceps	52
Tubing clamps	32	<b>WILDE-LANGE</b> , polypus snares	282, 314
<b>TÜBINGER MODELL</b> , retractors	152	<b>WILDER</b> , ductus salivatory dilators	275
<b>TÜBINGER</b> , ventilation tubes	307	<b>WILLIAMS-WATSON</b> , nasal cutting forceps	327
<b>TUFFIER</b> , blood vessel clamps	20	<b>WILLIGER</b> , bone curettes	214
Tuning Forks	303, 304	<b>WILLIGER</b> , elevators	216
<b>TYDING</b> , tonsil forceps	252	<b>WILLIGER</b> , mallets	207
<b>TYDING</b> , tonsil snares	254	<b>WILLIGER</b> , raspatories	216
		<b>WILMER</b> , iris scissors	76
<b>U</b>		<b>WINTER + IBE</b> , adapter	412
<b>UCKERMANN</b> , cotton applicators	155	<b>WISCONSIN(FOREGGER)</b> , fibre optic laryngoscopes	168
<b>UCKERMANN</b> , trocars	241	<b>WISCONSIN(FOREGGER)</b> , laryngoscopes	164
<b>UFFENORDE</b> , sharp curettes	348	<b>WOLF/HENKE-SASS</b> , adapter	412





---

Page

<b>WULLSTEIN MICRO</b> , suction tubes	159
<b>WULLSTEIN</b> , elevators	298
<b>WULLSTEIN</b> , knives	294
<b>WULLSTEIN</b> , micro ear forceps	288
<b>WULLSTEIN</b> , retractors	151
<b>WULLSTEIN</b> , suction tubes	300
<b>WULLSTEIN-HARTMANN</b> , ear forceps	284
<b>WÜRZBURG</b> , dissectors	249

**Y**

<b>YANKAUER</b> , nasal specula	312
<b>YANKAUER</b> , suction tubes	157
<b>YANKAUER-WALTON</b> , suction tubes	157
<b>YOUNG</b> , tongue holding forceps	240

**Z**

<b>ZAUFAL</b> , ear hooklets	290
<b>ZAUFAL-JANSEN</b> , bone rongeurs	225
<b>ZIEGLER</b> , cilia forceps	51
<b>ZÖLLNER</b> , suction tubes	300
Zoom-Adapter	413

# Indice alfabética

	Página		Página
<b>A</b>			
Abaja-lenguas	238, 239	<b>BACKHAUS</b> , pinzas de campo	31
<b>ABRAHAM</b> , bisturíes para amígdalas	247	<b>BACKHAUS</b> , pinzas para compresas	31
Abre-bocas	230-236	<b>BACON</b> , pinzas-gubias	224
Accesorios para (láser) laringoscopios para operaciones	177, 179, 180	<b>BAINBRIDGE</b> , pinzas hemostáticas	28
<b>ACM/HEINE</b> , adaptador	412	<b>BALL &amp; SOCKET</b> , pinzas de campo	31
Adaptador	412	<b>BALLENGER</b> , bisturíes para el tabique nasal	336
Adenótomos	354	<b>BALLENGER</b> , elevador para tabique	336
<b>ADLERKREUTZ</b> , pinzas de disección	42	<b>BALLENGER</b> , gubias	348
<b>ADSON</b> , pinzas de disección	36, 37	<b>BALLENGER</b> , pinzas para las amígdalas	252
<b>ADSON</b> , pinzas de disección tungsteno <b>TUC</b>	57	<b>BALLENGER-FOERSTER</b> , pinzas para esponjas	133, 134
<b>ADSON</b> , porta-agujas	105	<b>BALLENGER-SLUDER</b> , amígdalótomo	253
<b>ADSON</b> , tubos de aspiración	160	<b>BARBARA</b> , agujas auriculares	292, 293
<b>ADSON-BABY</b> , separadores autoestáticos	152	<b>BARBON-LUBET</b> , pinzas para pólipos	315
<b>ADSON-BROWN</b> , pinzas de disección	37	<b>BARNHILL</b> , cuchillos para vegetaciones adenoides	353
<b>ADSON-MICRO</b> , pinzas de disección	36	<b>BARON(SCHUKNECHT)</b> , tubos de aspiración	300
<b>ADSON-TOENNIS-DELICATE</b> , tijeras tungsteno <b>TUC</b>	93	<b>BARSKY</b> , instrumentos para la plástica nasal	346
<b>ADVENTITIA</b> , micro-tijeras	80, 82	<b>BARTH</b> , cucharillas auriculares	289
<b>AF</b> -instrumentos y accesorios	407-410	<b>BAUMGARTNER</b> , porta-agujas	105
Agrafes	127	<b>BEALES</b> , elevadores	299
Agujas auriculares	292, 293	<b>BECKMANN(NEGUS)</b> , cuchillos p.vegetaciones adenoides	353
Agujas de Reverdin	125	<b>BECKMANN</b> , cuchillos para vegetaciones adenoides	353
Agujas especiales/punción	156-162	<b>BECKMANN</b> , espéculos nasales	311
Agujas para amígdalas	251	<b>BEER</b> , pinzas depilatorias	51
Agujas para ligaduras	124, 125	<b>BELLUCCI</b> , micro pinzas auriculares	287
Agujas para paracentesis	291	<b>BERCHTOLD/MARTIN</b> , cables de conexión	406
Agujas para Septum	335	<b>BERCHTOLD/MARTIN</b> , mangos porta-electrodos	404
<b>ALDERDYCE</b> , elevadores	217	<b>BERCHTOLD/MARTIN</b> , mangos porta-electrodos con cable fijo	405
<b>ALEXANDER</b> , cinceles	198	<b>BERNHARD</b> , pinzas de campo	30
<b>ALLIGATOR</b> , pinzas para pólipos laríngeos	273	<b>BERNHARD</b> , pinzas para compresas	30
<b>ALLIS</b> , pinzas de aprehensión	398	<b>BEYER</b> , pinzas osteótomas	288
<b>ALLIS</b> , pinzas para coger tejidos	17	<b>BEYER</b> , pinzas-gubias	225
<b>ALM</b> , separadores autoestáticos	149	<b>BILLEAU</b> , asas auriculares	290
<b>ALY</b> , instrumentos sensibilidad	188	Biopsia	396
Amígdalótomo	253	Bisturíes para amígdalas	247
<b>ANDERSON-NEIVERT</b> , osteótomas	352	Bisturíes para el tabique nasal	336
<b>ANDREWS-PYNCHON</b> , tubos de aspiración	157	Bisturíes para operaciones de la nariz	334
Anestesia	163-166	<b>BLOHMKE</b> , pinzas para las amígdalas	252
<b>ARRUGA</b> , porta-agujas	102	<b>BLUMENTHAL</b> , pinzas-gubias	223
<b>ARRUGA</b> , porta-agujas tungsteno <b>TUC</b>	115	<b>BÖHLER</b> , pinzas-gubias	225
Artículos diversos	381-388	<b>BOIES</b> , instrumentos para la plástica nasal	356
Asas	290	<b>BOLGER-KUHN</b> , curetas cortantes	347
Asas auriculares	290	Bombillos de laringoscopia	206
<b>ASCH</b> , pinzas para enderezar el tabique nasal	355	<b>BONACCOLTO</b> , pinzas para sutura	54
Asideros, easyClean	394-399	<b>BONNEY</b> , pinzas de disección tungsteno <b>TUC</b>	58
<b>AUFRICHT GLABELLA</b> , escofinas nasal	340	<b>BOSE</b> , dilatadores	241
<b>AUFRICHT(WALTER)</b> , instrumentos para la plástica nasal	346	<b>BOSE</b> , separadores para la tráquea	242
<b>AUFRICHT</b> , elevador periósteo	336	<b>BÖTTCHER</b> , tijeras para amígdalas	72
<b>AUFRICHT</b> , escofinas nasal	340	<b>BOUCHERON</b> , espéculos auriculares	279
<b>AUFRICHT</b> , instrumentos para la plástica nasal	346	<b>BOWMAN</b> , sondas exploradoras para ductus salivarius	274
<b>AUSTIN</b> , micro-pinzas	46	<b>BOYLE-DAVIS</b> , abre-bocas	233
<b>B</b>			
<b>BABCOCK</b> , pinzas de aprehensión	399	<b>BOYNTON</b> , porta-agujas	102
<b>BABCOCK</b> , pinzas para coger intestinas	17	<b>BOYNTON</b> , porta-agujas tungsteno <b>TUC</b>	115
<b>BABY-ADSON</b> , separadores autoestáticos	152	<b>BRODIE</b> , sondas	154
<b>BABY-CRILE-WOOD</b> , porta-agujas	104	<b>BROPHY(SULLIVAN)</b> , tijeras finas	75
<b>BABY-CRILE-WOOD</b> , porta-agujas tungsteno <b>TUC</b>	111	<b>BROPHY</b> , pinzas de disección	40
<b>BABY-LEXER</b> , tijeras para preparaciones	71	<b>BROWN</b> , pinzas de disección	41
<b>BABY-METZENBAUM</b> , tijeras para preparaciones	66	<b>BROWN-ADSON</b> , pinzas de disección	37
<b>BABY-MILLER-SENN</b> , separadores finas	141	<b>BRUENINGS</b> , abaja-lenguas	239
<b>BABY-MIXTER</b> , pinzas para preparaciones y ligaduras	29	<b>BRUENINGS</b> , bisturíes para amígdalas	247
<b>BABY-POOLE</b> , tubos de aspiración	158	<b>BRUENINGS</b> , cierra-nudos para amígdalas	254
<b>BABY-SENN-MILLER</b> , separadores finas	141	<b>BRUENINGS</b> , espéculos auriculares	280
<b>BABY-WEITLANER</b> , separadores autoestáticos	150	<b>BRUENINGS</b> , pinzas intercambiables	256, 257
<b>BABY-WEITLANER</b> , separadores autoestáticos	150	<b>BRUENINGS</b> , pinzas para etmoides y para el tabique nasal	330
		<b>BRUENINGS-BRUNK</b> , separadores	358
		<b>BRUNS</b> , cucharillas cortantes	210, 213
		<b>BRYANT</b> , pinzas para esponjas	130
		<b>BUCK</b> , curetas auriculares	289
		<b>BUCK</b> , pinzas auriculares	283



<b>BUCK</b> , tijeras para ligaduras	78
<b>BUCKINGHAM</b> , instrumentos para la platina estapediense	296
<b>C</b>	
Cable fibra óptica	411
Cables de conexión	406, 407
Cadres de esterilización	364
<b>CAIRNS</b> , pinzas hemostáticas	27
Camisa para trocares y trocares	393
<b>CANFIELD</b> , bisturíes para amígdalas	247
Canula para las amígdalas	253
Cánulas irrigación	335
Cánulas traqueales	244
<b>CAPLAN</b> , tijeras nasales	73
<b>CARDIFF</b> , espéculos nasales	312
<b>CARDIOPHON</b> , estetoscopios	190
<b>CARPENTER</b> , bisturíes para amígdalas	247
<b>CARREL</b> , pinzas hemostáticas	21
<b>CARROLL</b> , porta-agujas	104
<b>CARROLL</b> , porta-agujas tungsteno <b>TUC</b>	109
<b>CARTER</b> , elevador para tabique	336
<b>CASTROVIEJO</b> , micro-porta-agujas tungsteno <b>TUC</b>	117
<b>CASTROVIEJO</b> , pinzas para romper hojas	100
<b>CASTROVIEJO</b> , pinzas para sutura	53
<b>CHADWICK</b> , tijeras oculares	77
<b>CHAPUT</b> , pinzas para coger	20
<b>CHEATLE</b> , pinzas para esterilización	364
<b>CHEVALIER-JACKSON</b> , cánulas traqueales	244
<b>CHILDE</b> , pinzas para agrafes	127
<b>CHRIS-TROUTMAN</b> , pinzas para romper hojas	100
Cierra-nudos para amígdalas	254
Cinceles	197-206, 299, 348-352
Cinceles y Gubias	197-206, 299, 348-352
Cinceles y Osteótomos	348-352
<b>CINELLI</b> , cinceles	351
<b>CITELLI</b> , pinzas osteótomos	288
Clamps bulldog	18, 19
<b>CLAR 55</b> , lámparas frontales	182
<b>CLAR STANDARD</b> , lámparas frontales	182
<b>CLAUS-HAJEK</b> , pinzas para seno esfenoidal	333
<b>CLAUS-KILLIAN</b> , gubias	348
<b>CLEVELAND</b> , pinzas cortantes para huesos	227
<b>CLEVELAND</b> , pinzas-gubias	222
<b>CLEVELAND-GARDNER</b> , pinzas cortantes p.huesos	226
<b>CLOWARD</b> , cucharillas contantes	213
<b>COAKLEY</b> , curetas	347
<b>COBB</b> , cinceles	204
<b>COLBURN-MILLER</b> , escofinas nasal	342
<b>COLLER</b> , pinzas hemostáticas	24
<b>COLLIER</b> , porta-agujas	102
<b>COLLIN</b> , mangos de bisturíes	97
<b>COLLIN</b> , martillos	207
<b>COLLIN</b> , pinzas para agrafes	126
<b>COLLIN</b> , pinzas tira-lengua	241
<b>COLLIN-DUVAL</b> , pinzas para coger	43
<b>COLLIN-HARTMANN</b> , separadores	146
<b>COLVER</b> , pinzas para amígdalas	252
<b>CONE</b> , separadores autoestáticos	152
Contenedor 1/1	376-380
Contenedor 1/2	368-371
Contenedor 3/4	371-375
Contenedor, endoscopia	385-387
<b>CONVERSE</b> , bisturíes para operaciones de la nariz	334
<b>CONVERSE</b> , cinceles	352
<b>CONVERSE</b> , ganchos	345
<b>CONVERSE</b> , instrumentos para la plástica nasal	346
<b>CONVERSE</b> , porta-agujas tungsteno <b>TUC</b>	110
<b>CONVERSE-DERF</b> , porta-agujas	102
Copas graduadas	360
<b>CORDES</b> , pinzas intercambiables	257
<b>CORWIN</b> , pinzas para torcer hilos tungsteno <b>TUC</b>	116

<b>COTTLE KAZANJIAN</b> , pinzas cortantes para huesos	226
<b>COTTLE(MILLARD)</b> , ganchos	345
<b>COTTLE</b> , bisturíes para operaciones de la nariz	334
<b>COTTLE</b> , cinceles	349
<b>COTTLE</b> , elevadores	338
<b>COTTLE</b> , escofinas nasal	340, 343
<b>COTTLE</b> , espéculos nasales	313
<b>COTTLE</b> , ganchos	344, 345
<b>COTTLE</b> , instrumentos para la plástica nasal	346
<b>COTTLE</b> , martillos	207, 302, 357
<b>COTTLE</b> , osteótomos	349
<b>COTTLE</b> , pinza para columela	346
<b>COTTLE</b> , pinzas nasales	52
<b>COTTLE</b> , tijeras nasales	73
<b>COTTLE</b> , trituradora de sustancia cartilaginosa	356
<b>COTTLE-NEIVERT</b> , ganchos	345
<b>COUPLAND</b> , tubos de aspiración	158
<b>CRAIG</b> , pinzas para etmoides y para el tabique nasal	330
<b>CRILE</b> , pinzas hemostáticas	24
<b>CRILE</b> , porta-agujas	107
<b>CRILE-MURRAY</b> , porta-agujas	104
<b>CRILE-RANKIN</b> , pinzas hemostáticas	24
<b>CRILE-WOOD</b> , porta-agujas	104
<b>CRILE-WOOD</b> , porta-agujas tungsteno <b>TUC</b>	111
<b>CRILE-WOOD-BABY</b> , porta-agujas	104
<b>CRILE-WOOD-BABY</b> , porta-agujas tungsteno <b>TUC</b>	111
<b>CRURA-NIPPER</b> , micro pinzas auriculares	286
Cubetas	360, 363
Cucharillas	289, 347, 348
Cucharillas auriculares	289
Cuchillo para tabique	336
Cuchillos para vegetaciones adenoides	353, 354
Cuchillos para amígdalas	247
Cunas	360
Curetas	210-214, 289, 298, 347, 348
Curetas auriculares	289, 298, 299
<b>CUSHING</b> , ganchos	137
<b>CUSHING</b> , pinzas de disección	39
<b>CUSHING</b> , pinzas de disección tungsteno <b>TUC</b>	57
<b>CUSHING-TAYLOR</b> , pinzas de disección tungsteno <b>TUC</b>	57

**D**

<b>DAHMEN</b> , cinceles	205
<b>DAHMEN</b> , gubias	205
<b>DANDY</b> , pinzas hemostáticas para pericráneo	28
<b>DAVIS-BOYLE</b> , abre-bocas	233
<b>DAVIS-MAYER</b> , abre-bocas	235
<b>DAVIS-RAGNELL</b> , ganchos	141
<b>DAVIS-RAGNELL</b> , separadores finas	141
<b>DE BAKEY</b> , pinzas atrauma	55
<b>DE BAKEY</b> , pinzas de aprehensión	398
<b>DE BAKEY</b> , pinzas de disección tungsteno <b>TUC</b>	58
<b>DE BAKEY</b> , porta-agujas tungsteno <b>TUC</b>	108
<b>DE BAKEY</b> , tubos de aspiración	157
<b>DE LA ROZA</b> , agujas para ligaduras	125
de luz fría	346
<b>DEAVER</b> , tijeras para cirugía	64
Dedales	230
<b>DENHART</b> , abre-bocas	231
<b>DERF</b> , porta-agujas	102
<b>DERF</b> , porta-agujas tungsteno <b>TUC</b>	110
<b>DERF-CONVERSE</b> , porta-agujas	102
<b>DERLACKI-SHAMBAUGH</b> , legbras	298
Dermatomos	99, 100
<b>DESMARRES</b> , separadores finas	141
Diagnostico	181-194
Diapasones	303, 304
<b>DIEFFENBACH</b> , clamps bulldog	19
<b>DIETER</b> , micro pinzas auriculares	287
<b>DIETRICH</b> , micro-porta-agujas tungsteno <b>TUC</b>	117
Dilatadores	241

	Página		Página
Dilatadores para ductus salivarius	275	<b>FEILCHENFELD</b> , pinzas para espinas	48
Dilatadores para el seno frontal	335	<b>FEIN</b> , porta-algodones	155
Dilatadores para vasos	47	<b>FERGUSON</b> , tubos de aspiración	159
<b>DINGMANN</b> , abre-bocas	233	<b>FERREIRA</b> , seperadores	148
Disecadores	248-250, 307	<b>FERRIS-SMITH</b> , pinzas de disección	42
Disección en punta	396, 400	<b>FERRIS-SMITH</b> , pinzas para seno esfenoidal	333
Disección roma	397	<b>FINSEN</b> , separadores autoestaticos	149
<b>DISECCION</b> , micro-tijeras	80, 82	<b>FISCH</b> , disecadores	295
Disectores, Face-Lift	218-221	<b>FISCH</b> , gancho con platina	297
<b>DIXON-LOVELACE</b> , pinzas hemostáticas	28	<b>FISCHER</b> , bisturíes para amígdalas	247
<b>DOLPHIN</b> , disección roma	397, 400	<b>FOERSTER-BALLENGER</b> , pinzas para esponjas	133, 134
<b>DOUGHTY-KILNER</b> , abre-bocas	232	<b>FOMON</b> , bisturíes para operaciones de la nariz	334
<b>DOUGLAS</b> , bisturíes para amígdalas	247	<b>FOMON</b> , cinceles	351
<b>DOUGLAS</b> , pinzas depilatorias	51	<b>FOMON</b> , escofinas nasal	341, 343
<b>DOYEN</b> , abaja-lenguas	239	<b>FOMON</b> , ganchos	344
<b>DOYEN</b> , pinzas de campo	30	<b>FOMON</b> , tijeras nasales	73
<b>DOYEN</b> , pinzas para compresas	30	<b>FOMON</b> , tijeras para preparaciones	70
<b>DOYEN</b> , porta-agujas	102	<b>FOREGGER(WISCONSIN)</b> , fibre optic laringoscopios	168
<b>DOYEN</b> , sondas	153	<b>FOREGGER(WISCONSIN)</b> , laringoscopios	164
<b>DRAFFIN</b> , soporte de pecho bipod	236	<b>FOX</b> , cucharillas cortantes	212
<b>DUCKBILL</b> , pinzas auriculares	284	<b>FOX-GOLDMAN</b> , tijeras tungsteno <b>TUC</b>	93
<b>DUEHRSEN</b> , pinzas de disección	41	<b>FRAENKEL</b> , pinzas intercambiables	257
<b>DUNHILL</b> , pinzas hemostáticas	27	<b>FRAENKEL</b> , pinzas para pólipos laríngeos	272, 273
<b>DUPLAY(VOLTOLINI)</b> , espéculos nasales	313	<b>FRAZIER</b> , ganchos	135
<b>DUPLAY</b> , pinzas para pólipos	133	<b>FRAZIER</b> , tubos de aspiración	159
<b>DUPLEX</b> , estetoscopios	190	<b>FREEMAN-GORNEY</b> , tijeras para face-lift	69
<b>DUPUY WEISS</b> , agujas para amígdalas	251	<b>FREER</b> , cinceles	348
<b>DURANTE</b> , pinzas para coger	44	<b>FREER</b> , elevador aspirador	335
<b>DUVAL</b> , pinzas para coger	44	<b>FREER</b> , elevadores	217, 337
<b>DUVAL-COLLIN</b> , pinzas para coger	43	<b>FREER</b> , ganchos	344
<b>E</b>		<b>FREER</b> , gubias	348
easyClean	394-399	<b>FREER</b> , instrumentos de rinoplastia	334
<b>ECONOM</b> , juegos para diagnóstico	192	<b>FRENCH-EYE/Ryder</b> , porta-agujas tungsteno <b>TUC</b>	108
<b>EICKEN-KILLIAN</b> , tubos de aspiración	159	<b>FRENCH-HARTMANN</b> , diapasones	303
Electrodos	408, 409	<b>FRENZEL</b> , abaja-lenguas	239
Elevador aspirador	335	<b>FRIEDMAN</b> , pinzas-gubias	222
Elevadores	216, 217, 298, 299	<b>FULLER</b> , micro pinzas auriculares	287
Elevadores para el tabique nasal	336-338	<b>G</b>	
Elevadores para velo palatino	226	Gafas nistagmo	186, 187
Endoscopia	399-413	<b>GALLAGHER</b> , escofinas nasal	340
Endoscopios	401, 402	Ganchitos	290
<b>ENGL.MODELL</b> , pinzas de campo	30	Ganchitos auriculares	290, 292, 293
<b>ENGL.MODELL</b> , pinzas para compresas	30	Ganchos	135-152, 240, 241, 358
<b>ERBE (U.S.)</b> , mangos porta-electrodos con cable fijo	405	<b>GARDNER-CLEVELAND</b> , pinzas cortanes para huesos	226
<b>ERBE</b> , cables de conexión	406	Garrotes	230, 237
<b>ERBE</b> , mangos porta-electrodos	404	<b>GELFOAM-HOUSE</b> , pinza de presión	307
<b>ERBE/SELECT</b> , cables de conexión	406	<b>GEMINI</b> , pinzas para preparaciones y ligaduras	29
Escofinas nasal	340-343	<b>GERALD</b> , pinzas de disección	39
Espéculo nasolaringeal	312	<b>GILLIES</b> , ganchos	135
Espéculos auriculares	278-281	<b>GILLIES</b> , pinzas de disección	43
Espéculos nasales	311-313	<b>GILLIES</b> , pinzas de disección tungsteno <b>TUC</b>	56
Espejo, laríngeos	271	<b>GILLIES</b> , porta-agujas	106
Espejo, postrinoscópico	272	<b>GILLIES</b> , porta-agujas tungsteno <b>TUC</b>	113
Espejos de boca	269, 270	<b>GLASSMANN</b> , pinzas de aprehensión	398
Espejos frontales	181, 183	<b>GOLDMAN-FOX</b> , tijeras tungsteno <b>TUC</b>	93
Espejos laríngeos	271	<b>GOLDMANN</b> , instrumentos para la plástica nasal	356
Estetoscopios	189, 190	<b>GOLDSMITH(THUDICHUM)</b> , espéculos nasales	313
Estuche para traqueotomía	245	<b>GOOD</b> , tijeras para amígdalas	72
Estuches para esterilizar agujas	361	<b>GOOD-SCHWECKENDICK</b> , tijeras para amígdalas	72
<b>EUFRATE PASQUE MICROVASCULAR</b> , porta-agujas <b>TUC</b>	109	<b>GORNEY</b> , elevador aspirador	335
<b>EVES</b> , cierra-nudos para amígdalas	254	<b>GORNEY</b> , pinzas para preparaciones	70
<b>EWALD</b> , pinzas de disección	37	<b>GORNEY-FREEMAN</b> , tijeras para face-lift	69
<b>F</b>		<b>GRAEFE</b> , ganchos	136
Face-Lift disectores	218-221	<b>GRAZIL</b> , tijeras para cirugía	63
<b>FARABEUF</b> , separadores	147	<b>GREEN-SENN</b> , separadores finas	140
<b>FARRELL</b> , porta-algodones	154	<b>GROSS</b> , ganchitos auriculares	290
<b>FARRIOR</b> , espéculos auriculares	279	<b>GROSS-MAIER</b> , pinzas para pólipos	131, 132
<b>FAULKNER</b> , curetas	347	<b>GRUBER</b> , espéculos auriculares	278
		<b>GRUENWALD (JANSEN)</b> , pinzas nasales	52
		Gubias	197-206, 299, 348



<b>GUEDEL</b> , cánulas traqueales	244
<b>GUILEN</b> , cánulas irrigación	335
<b>GUTHRIE</b> , ganchos	139
<b>GWYNNE</b> , disecadores	250

**H**

<b>HAJEK</b> , martillos	302
<b>HAJEK-CLAUS</b> , pinzas para seno esfenoidal	333
<b>HAJEK-KOFFLER</b> , pinzas para seno esfenoidal	332
<b>HALLE</b> , curetas cortantes	348
<b>HALLE</b> , elevadores	337
<b>HALLE</b> , tijeras nasales	73
<b>HALLE-HARTMANN</b> , espéculos nasales	311
<b>HALLE-RITTER</b> , dilatadores para el seno frontal	335
<b>HALLE-TIECK</b> , espéculos nasales	311
<b>HALSEY</b> , porta-agujas	103
<b>HALSEY</b> , porta-agujas tungsteno <b>TUC</b>	110
<b>HALSTED</b> , pinzas hemostáticas	22
<b>HALSTED-MOSQUITO</b> , pinzas hemostáticas	22
<b>HARMS</b> , pinzas para sutura	54
<b>HARRISON (PYE-SMITH)</b> , pinzas para esterilización	364
<b>HARTMANN</b> , abaja-lenguas	238
<b>HARTMANN</b> , diapasones	303
<b>HARTMANN</b> , espéculos auriculares	278
<b>HARTMANN</b> , espéculos nasales	311
<b>HARTMANN</b> , ganchitos auriculares	290
<b>HARTMANN</b> , pinzas auriculares	283, 284
<b>HARTMANN</b> , pinzas cortantes para amígdalas	255
<b>HARTMANN</b> , pinzas cortantes para nariz	328
<b>HARTMANN</b> , pinzas hemostáticas	21
<b>HARTMANN</b> , pinzas para pólipos	315
<b>HARTMANN</b> , pinzas-gubias	223
<b>HARTMANN</b> , tubos de aspiración	302
<b>HARTMANN-COLLIN</b> , separadores	146
<b>HARTMANN-FRENCH</b> , diapasones	303
<b>HARTMANN-HALLE</b> , espéculos nasales	311
<b>HARTMANN-HOFFMANN</b> , pinzas auriculares	284
<b>HARTMANN-NOYES</b> , pinzas auriculares	284
<b>HARTMANN-WULLSTEIN</b> , pinzas auriculares	284
<b>HEATH-RICHTER</b> , pinzas para agrafes	126
<b>HEERMANN</b> , instrumentos para la platina estapediense	297
<b>HEGAR-MAYO</b> , porta-agujas	105
<b>HEGAR-MAYO</b> , porta-agujas tungsteno <b>TUC</b>	108
<b>HEGAR-MAYO-DELICATE</b> , porta-agujas	105
<b>HEGAR-MAYO-DELICATE</b> , porta-agujas tungsteno <b>TUC</b>	108
<b>HEGAR-OLSEN</b> , porta-agujas	106
<b>HEGAR-OLSEN</b> , porta-agujas tungsteno <b>TUC</b>	113
<b>HEGENBARTH</b> , pinzas para agrafes	126
<b>HEISTER</b> , abre-bocas	230
<b>HENKE</b> , disecadores	248
<b>HENKE-SASS/WOLF</b> , adaptador	412
<b>HENLEY</b> , separadores autoestáticos	150
<b>HERBERHOLD</b> , abre-bocas	235
<b>HESSBERG</b> , agujas para ligaduras	125
<b>HEYMANN</b> , pinzas para etmoides y para el tabique nasal	330
<b>HEYMANN</b> , tijeras nasales	73
<b>HEYMANN-KNIGHT</b> , pinzas para pólipos	315
<b>HIBBS SPRATT</b> , cucharillas cortantes	213
<b>HIBBS</b> , cinceles	200
<b>HIBBS</b> , gubias	200
<b>HILGER</b> , espejo de boca	269
<b>HOEN</b> , elevadores	217
<b>HOFER</b> , retractores para amígdalas	251
<b>HOKE</b> , gubias	197
<b>HOLINGER</b> , laringoscopios	178
<b>HOPKINS-JOHNS</b> , clamps bulldog	19
<b>HOPKINS-JOHNS</b> , pinzas para poner	19
<b>HORNE-JOBSON</b> , porta-algodones	155
<b>HOSPITAL-PROVIDENCE</b> , pinzas hemostáticas	23
<b>HOUSE</b> , instrumentos para la platina estapediense	296
<b>HOUSE</b> , micro instrumentos	295

<b>HOUSE</b> , tubos de aspiración	300
<b>HOUSE-GELFOAM</b> , pinza de presión	307
<b>HOWARTH</b> , elevadores	338
<b>HUBER</b> , mango universal	256
<b>HUMBY</b> , dermatomo	99
<b>HUMBY</b> , instrumentos para la plástica nasal	346
<b>HUNTER</b> , pinzas de aprehensión	399
<b>HUNTER</b> , pinzas para espinas	48
<b>HUPP</b> , separadores para la tráquea	243
<b>HURD</b> , disecadores	248

**I**

Insertos de trabajo, easyClean	396-399
Instrumento de sutura	107
Instrumentos para amígdalas	250, 252
Instrumentos para la plástica nasal	339, 346, 356
Instrumentos para la platina estapediense	296, 297
Instrumentos sensibilidad	188
Insufladores	305
<b>ITERSON</b> , separadores para la tráquea	242

**J**

<b>JACKSON</b> , laringoscopios con luz fría	178
<b>JACKSON</b> , separadores para la tráquea	243
<b>JACKSON-CHEVALIER</b> , cánulas traqueales	244
<b>JACOBI</b> , agujas para ligaduras	125
<b>JACOBSON</b> , porta-agujas tungsteno <b>TUC</b>	109
<b>JALASVIRTA</b> , pinzas auriculares	52
<b>JANET</b> , jeringas	161
<b>JANSEN (GRUENDWALD)</b> , pinzas nasales	52
<b>JANSEN</b> , cucharillas auriculares	289
<b>JANSEN</b> , cucharillas cortantes	214
<b>JANSEN</b> , elevadores	299
<b>JANSEN</b> , pinzas nasales	52
<b>JANSEN</b> , separadores autoestáticos	149
<b>JANSEN-MIDDLETON</b> , pinzas cortantes para nariz	329
<b>JANSEN-ZAUFAL</b> , pinzas-gubias	225
<b>JATHO</b> , pinzas para nariz	331
<b>JENNINGS</b> , abre-bocas	231
Jeringas	161, 306
Jeringas auriculares	306
<b>JEWELER</b> , pinzas de disección tungsteno <b>TUC</b>	56
<b>JOBSON-HORNE</b> , porta-algodones	155
<b>JOHNS-HOPKINS</b> , clamps bulldog	19
<b>JOHNS-HOPKINS</b> , pinzas para poner	19
<b>JONES</b> , pinzas de campo	30
<b>JONES</b> , pinzas para compresas	30
<b>JOSEPH</b> , bisturíes para operaciones de la nariz	334
<b>JOSEPH</b> , elevadores	337
<b>JOSEPH</b> , escofinas nasal	340
<b>JOSEPH</b> , ganchos	139, 344
<b>JOSEPH</b> , instrumentos para la plástica nasal	339, 356
<b>JOSEPH</b> , tijeras para preparaciones	71
<b>JOSEPH-MASING</b> , elevadores	337
Juegos para diagnóstico	192, 193

**K**

<b>KABIERSKE</b> , pulverizadores	305
<b>KALT</b> , micro-porta-agujas tungsteno <b>TUC</b>	117
<b>KAYE</b> , tijeras para Face-lift	93
<b>KAZANJIAN</b> , pinzas para nariz	331
<b>KELLY(RICHARDSON)</b> , separadores	145
<b>KELLY</b> , pinzas hemostáticas	24
<b>KELLY-RANKIN</b> , pinzas hemostáticas	24
<b>KELMAN-McPHERSON</b> , pinzas para sutura	53
<b>KERRISON</b> , pinzas para seno esfenoidal	332
<b>KILLIAN</b> , elevadores	338
<b>KILLIAN</b> , espéculos nasales	312
<b>KILLIAN</b> , gubias	348



	Página		Página
<b>KILLIAN</b> , pinzas para pólipos	315	<b>LEXER</b> , gubias	202, 203
<b>KILLIAN</b> , tijeras para el tabique	272	<b>LEXER</b> , tijeras para preparaciones	70
<b>KILLIAN-CLAUS</b> , gubias	348	<b>LEXER</b> , tijeras tungsteno <b>TUC</b>	90
<b>KILLIAN-EICKEN</b> , tubos de aspiración	159	<b>LEXER-BABY</b> , tijeras para preparaciones	71
<b>KILNER(RAGNELL)</b> , tijeras para preparaciones	71	<b>LEXER-MINI</b> , cinceles	202
<b>KILNER</b> , ganchos	135, 345	<b>LEXER-MINI</b> , gubias	202
<b>KILNER</b> , porta-agujas	103	<b>LICHTENBERG</b> , porta-agujas tungsteno <b>TUC</b>	115
<b>KILNER</b> , porta-agujas tungsteno <b>TUC</b>	110	<b>LICHTWITZ</b> , trocares	156
<b>KILNER-DOUGHTY</b> , abre-bocas	232	<b>LISTER</b> , pinzas para tapones	130
<b>KLEINERT-KUTZ</b> , ganchos	135	<b>LISTER</b> , tijeras tungsteno <b>TUC</b>	93
<b>KLEINERT-KUTZ</b> , pinzas-gubias	225	<b>LISTON</b> , pinzas cortantes para huesos	226
<b>KLINIKUM BERLIN</b> , pinzas para tubos	32	<b>LISTON-RUSKIN</b> , pinzas cortantes para huesos	227
<b>KNAPP</b> , ganchos	139	<b>LISTON-WALTON</b> , pinzas cortantes para huesos	227
<b>KNIGHT</b> , pinzas para etmoides y para el tabique nasal	330	<b>LITTAUER</b> , pinzas depilatorias	51
<b>KNIGHT-HEYMANN</b> , pinzas para pólipos	315	<b>LITTAUER</b> , tijeras para ligaduras	77
<b>KOCHER</b> , separadores	142, 144	<b>LITTAUER-LISTON</b> , pinzas cortantes para huesos	226
<b>KOCHER</b> , sondas	246	<b>LITTLE</b> , separadores	144
<b>KOCHER-DELICATE</b> , pinzas hemostáticas	27	<b>LITTLER</b> , tijeras finas	75
<b>KOCHER-LANGENBECK</b> , separadores	143	Llaves	162
<b>KOCHER-OCHSNER</b> , pinzas hemostáticas	26	<b>LOCKHART-MUMMERY</b> , sondas	154
<b>KOFFLER-HAJEK</b> , pinzas para seno esfenoidal	332	<b>LOPEZ-REINKE</b> , disecadores	249
<b>KRAUSE</b> , pinzas intercambiables	257	<b>LORNA</b> , pinzas de campo	31
<b>KRAUSE</b> , polipótomos	282, 314	<b>LORNA</b> , pinzas para compresas	31
<b>KRAUSE-VOSS</b> , polipótomos	282, 314	<b>LOVELACE-DIXON</b> , pinzas hemostáticas	28
<b>KRESSNER</b> , instrumentos para la plástica nasal	356	<b>LUBET-BARBON</b> , pinzas para pólipos	315
<b>KROENIG</b> , abaja-lenguas	239	<b>LUC</b> , pinzas para etmoides y para el tabique nasal	330
<b>KROENLEIN</b> , pinzas para coger	20	<b>LUCAE</b> , agujas para paracentesis	291
<b>KRONECKER</b> , agujas para ligaduras	125	<b>LUCAE</b> , diapasones	303
<b>KRONE-MARSCHIK</b> , pinzas para las amígdalas	252	<b>LUCAE</b> , ganchitos auriculares	290
<b>KUHN-BOLGER</b> , curetas cortantes	347	<b>LUCAE</b> , martillos	208
<b>KUTZ-KLEINERT</b> , ganchos	135	<b>LUCAE</b> , pinzas nasales	52
<b>KUTZ-KLEINERT</b> , pinzas-gubias	225	<b>LUCAS</b> , cinceles	197
<b>L</b>			
<b>LA FORCE</b> , adenótomos	354	<b>LUER</b> , cánulas traqueales	244
<b>LABORDE</b> , dilatadores	241	<b>LUER</b> , pinzas-gubias	223
<b>LACK</b> , abaja-lenguas	238	<b>LUER</b> , separadores para la tráquea	243
<b>LAHEY</b> , pinzas para el bocio	246	<b>LUKENS</b> , separadores para la tráquea	242
<b>LAHEY</b> , separadores	144	<b>LUNIATSCHECK</b> , disecadores	249
<b>LAMBOTTE</b> , gubias	206	<b>M</b>	
<b>LAMBOTTE-MINI</b> , gubias	206	<b>MACKAY</b> , cuchillo de hoz	347
Lámparas frontales	181-185	<b>MACKAY</b> , curetas cortantes	347
<b>LANE</b> , pinzas de campo	30	<b>MAGILL</b> , pinzas para catéteres	171
<b>LANE</b> , pinzas de disección	38	<b>MAIER-GROSS</b> , pinzas para pólipos	131, 132
<b>LANE</b> , pinzas para compresas	30	<b>MALTZ</b> , escofinas nasal	340
<b>LANG</b> , ganchos	344	Mangos de bisturíes	96-98
<b>LANG</b> , pinzas intercambiables	257	Mangos de pila (sin pilas)	206
<b>LANG</b> , pinzas para agrafes	127	Mangos para espejo de boca	268
<b>LANG</b> , pinzas para pólipos laríngeos	273	Mangos porta-electrodos	404
<b>LANGENBECK</b> , curetas auriculares	289	Mangos porta-electrodos con cable fijo	405
<b>LANGENBECK</b> , dedales	230	Mangos universales y pinzas intercambiables	256, 257
<b>LANGENBECK</b> , elevadores	216	Manómetros para la presión de la sangre	191
<b>LANGENBECK</b> , porta-agujas	107	Marcador para facelift	188
<b>LANGENBECK</b> , porta-agujas tungsteno <b>TUC</b>	116	<b>MARLIN</b> , material de sutura	250
<b>LANGENBECK</b> , raspadores	215	<b>MARQUARDT</b> , pinzas-gubias	224
<b>LANGENBECK</b> , separadores	141	<b>MARSCHIK</b> , pinza para amígdalas	250
<b>LANGENBECK-DELICATE</b> , porta-agujas tungsteno <b>TUC</b>	116	<b>MARSCHIK-KRONE</b> , pinzas para las amígdalas	252
<b>LANGENBECK-MINI</b> , separadores finas	140	<b>MARTEL</b> , pinzas hemostáticas para pericráneo	20
<b>LANGENBECK-RYDER</b> , porta-agujas tungsteno <b>TUC</b>	116	Martillos	207-209, 302, 357
<b>LANG</b> -WILDE, polipótomos	282, 314	<b>MARTIN</b> , espéculos nasales	312
Laringoscopios	163-166	<b>MARTIN/BERCHTOLD</b> , cables de conexión	406
Laringoscopios con luz fría	167-170, 178	<b>MARTIN/BERCHTOLD</b> , mangos porta-electrodos	404
Laringoscopios para operaciones	172-180	<b>MARTIN/BERCHTOLD</b> , mangos porta-electrodos con cable fijo	405
<b>LARKIN</b> , instrumentos para la platina estapediense	296	<b>MARTINI</b> , cucharillas cortantes	214
<b>LEMPERT</b> , curetas	298	<b>MARYLAND</b> , disección roma	397
<b>LEMPERT</b> , elevadores	298	<b>MASING</b> , bisturíes para operaciones de la nariz	334
<b>LEMPERT</b> , legras	298	<b>MASING</b> , cinceles	352
<b>LEMPERT</b> , pinzas-gubias	224	<b>MASING</b> , elevadores	338
<b>LERICHE</b> , pinzas hemostáticas	23	<b>MASING</b> , escofinas nasal	341
<b>LEWIS</b> , escofinas nasal	340, 343	<b>MASING</b> , ganchos	345
<b>LEXER</b> , cinceles	202, 203	<b>MASING-JOSEPH</b> , elevadores	337
		<b>MASS.-GENERAL-HOSPITAL</b> , porta-agujas	105



<b>MASTIN</b> , pinza para músculos	246	<b>MINI</b> , mangos de bisturíes	98
<b>MATHIEU</b> , porta-agujas	106	<b>MINI-FRIEDMAN</b> , pinzas-gubias	222
<b>MATHIEU</b> , porta-agujas tungsteno <b>TUC</b>	113	<b>MINI-LAMBOTTE</b> , gubias	206
<b>MATHIEU-DELICATE</b> , porta-agujas	106	<b>MINI-LANGENBECK</b> , separadores finas	140
<b>MATHIEU-DELICATE</b> , porta-agujas tungsteno <b>TUC</b>	114	<b>MINI-LEXER</b> , cinceles	202
<b>MATHIEU-RYDER VASCULAR</b> , porta-agujas tungsteno <b>TUC</b>	114	<b>MINI-LEXER</b> , gubias	202
<b>MATHIEU-RYDER</b> , porta-agujas tungsteno <b>TUC</b>	114	<b>MINI-RUSKIN</b> , pinzas-gubias	225
<b>MAUNDER</b> , garrote	230	<b>MIXTER</b> , tijeras para cirugía	64
<b>MAYER-DAVIS</b> , abre-bocas	235	<b>MIXTER-BABY</b> , pinzas para preparaciones y ligaduras	29
<b>MAYFIELD</b> , pinzas-gubias	224	<b>MIXTER-O'SHAUGNESSY</b> , pinzas para preparaciones y ligaduras	29
<b>MAYO</b> , abaja-lenguas	239	<b>MOD. BONN</b> , pinzas para sutura	54
<b>MAYO</b> , cadres de esterilización	364	<b>MOD. BONN</b> , tijeras finas	76
<b>MAYO</b> , tijeras	65	<b>MOD. TÜBINGEN</b> , pinzas para sutura	54
<b>MAYO</b> , tijeras tungsteno <b>TUC</b>	87	<b>MOD. WIEN</b> , espéculos nasales	312
<b>MAYO-HEGAR</b> , porta-agujas	105	<b>MOD. WÜRZBURG</b> , abre-bocas	234
<b>MAYO-HEGAR</b> , porta-agujas tungsteno <b>TUC</b>	108	<b>MODELL TÜBINGEN</b> , separadores autoestáticos	152
<b>MAYO-HEGAR-DELICATE</b> , porta-agujas	105	<b>MODELL USA</b> , pinzas de disección	36
<b>MAYO-HEGAR-DELICATE</b> , porta-agujas tungsteno <b>TUC</b>	108	<b>MOLDESTADT</b> , ganchos	137
<b>MAYO-STILLE</b> , tijeras	65	<b>MOLLISON</b> , disecadores	249
<b>MAYO-STILLE</b> , tijeras tungsteno <b>TUC</b>	88	<b>MOLLISON</b> , separadores autoestáticos	151
<b>MC INDOE</b> , instrumentos para la plástica nasal	346	<b>MOLT</b> , abre-bocas	230
<b>MC INDOE</b> , pinzas cortantes para huesos	227	<b>MORITZ-SCHMIDT</b> , abaja-lenguas	238
<b>MC INDOE</b> , pinzas de disección	37	<b>MOSHER-WAGENER</b> , bocio	243
<b>MC INTOSH</b> , fibre optic laringoscopios	167	<b>MOSQUITO-HALSTED</b> , pinzas hemostáticas	22
<b>MC INTOSH</b> , laringoscopios	163	<b>MOSQUITO-MICRO</b> , pinzas hemostáticas	22
<b>MC IVOR</b> , abre-bocas	234	<b>MUCK</b> , cuchillos	299
<b>MCDONALD</b> , elevadores	217	<b>MULDOON</b> , dilatadores para ductus salivarius	275
<b>MCGEE</b> , ganchitos auriculares	293	<b>MUMMERY-LOCKHART</b> , sondas	154
<b>MCGEE</b> , micro pinzas auriculares	286	<b>MURRAY-CRILE</b> , porta-agujas	104
<b>MCKENTY</b> , elevadores	337	<b>MUSEUX</b> , pinzas para las amígdalas	252
<b>MCKERNAN</b> , pinzas de aprehensión	399	<b>MYLES</b> , cánulas irrigación	335
<b>MCKESSON</b> , garrotes	237	<b>MYRTLE LEAF</b> , sondas	153
<b>MCPHERSON</b> , pinzas para sutura	53		
<b>MEAD</b> , martillos	208	<b>N</b>	
<b>MEAD</b> , pinzas-gubias	223	<b>NAGER</b> , elevadores para velo palatino	251
Medidas diversos y accesorios	359-364	<b>NASOPHARYNGOSCOPIO FLEXIBLE</b>	403
<b>METZENBAUM</b> , porta-agujas tungsteno <b>TUC</b>	114	<b>NEGUS(BECKMANN)</b> , cuchillos p.vegetaciones adenoides	353
<b>METZENBAUM</b> , tijera para endoscopia	396, 400	<b>NEGUS</b> , elevador aspirador	335
<b>METZENBAUM</b> , tijeras para preparaciones	65, 66	<b>NEGUS</b> , soporte contra-pecho para abre-bocas	236
<b>METZENBAUM</b> , tijeras tungsteno <b>TUC</b>	88, 89	<b>NEIVERT</b> , osteótomos	352
<b>METZENBAUM-BABY</b> , tijeras para preparaciones	66	<b>NEIVERT</b> , porta-agujas	103
<b>METZENBAUM-DELICATE</b> , tijeras para preparaciones	68	<b>NEIVERT</b> , porta-agujas tungsteno <b>TUC</b>	110
<b>METZENBAUM-DELICATE</b> , tijeras tungsteno <b>TUC</b>	90, 91	<b>NEIVERT-ANDERSON</b> , osteótomos	352
<b>METZENBAUM-NELSON</b> , tijeras para preparaciones	67	<b>NEIVERT-COTTLE</b> , ganchos	345
<b>MEYERDING</b> , separadores finas	140	<b>NELATON</b> , sondas	153
<b>MICHEL</b> , agrafes	127	<b>NELSON-METZENBAUM</b> , tijeras para preparaciones	67
<b>MICHEL</b> , espejos laríngeos	271	<b>NEW ORLEANS</b> , porta-agujas tungsteno <b>TUC</b>	109
<b>MICHEL</b> , pinzas para agrafes	126	<b>NEWS</b> , separadores para la tráquea	243
Micro instrumentos	295	<b>NIJMEGEN</b> , tubos de aspiración	159
Micro pinzas auriculares	285-288	<b>NOLST-TRENITÉ JOSEPH</b> , instrumentos para la plástica nasal	339
Micro, pinzas	46, 47	<b>NOLST-TRENITÉ</b> , osteótomos	350
Micro, porta-agujas	117-123	<b>NORTHBENT</b> , tijeras para ligaduras	78
Micro, tijeras	79-84	<b>NOYES-HARTMANN</b> , pinzas auriculares	284
Micro, tijeras Adventitia	80, 82		
Micro, tijeras Disección	80, 82	<b>O</b>	
<b>MICRO-ADSON</b> , pinzas de disección	36	<b>O'BRIAN</b> , tijeras finas	76
Microcirugía endolaríngea	259-266	<b>O'CONNOR</b> , ganchos	136
<b>MICRO-MOSQUITO</b> , pinzas hemostáticas	22	<b>O'SHAUGNESSY-MIXTER</b> , pinzas para preparaciones y ligaduras	29
Micro-porta-agujas con mango redondo	118-121	<b>OBWEGESER</b> , osteótomos	352
<b>MICRO-RYDER</b> , porta-agujas tungsteno <b>TUC</b>	108	<b>OBWEGESER</b> , separadores	143
<b>MICROVASCULAR-EUFRATE PASQUE</b> , porta-agujas <b>TUC</b>	109	<b>OCHSNER-KOCHER</b> , pinzas hemostáticas	26
<b>MICRO-WULLSTEIN</b> , tubos de aspiración	159	<b>OEHLER</b> , pinzas de disección tungsteno <b>TUC</b>	56
<b>MIDDELDORPF</b> , separadores	145	<b>OLSEN-HEGAR</b> , porta-agujas	106
<b>MIDDLETON-JANSEN</b> , pinzas cortantes para nariz	329	<b>OLSEN-HEGAR</b> , porta-agujas tungsteno <b>TUC</b>	113
<b>MILLARD(COTTLE)</b> , ganchos	345	<b>OLYMPUS</b> , adaptador	412
<b>MILLER</b> , fibre optic laringoscopios	169	Ortopedia	195-228
<b>MILLER</b> , laringoscopios	165	Osteótomos y Cinceles	349-352
<b>MILLER-COLBURN</b> , escofinas nasal	342	Oto-/oftalmoscopia	193
<b>MILLER-SENN</b> , ganchos	141	Otoscopio, video	194
<b>MILLER-SENN</b> , separadores finas	141	<b>OTOSKOP UNI</b> , juegos para diagnóstico	193
<b>MILLER-SENN-BABY</b> , separadores finas	141		
<b>MILLIGAN</b> , separadores autoestáticos	151		

**P**

<b>PARKER</b> , separadores	147
<b>PARTSCH</b> , cinceles	198
<b>PARTSCH</b> , martillos	208
<b>PASSOW</b> , cinceles	299
<b>PAUFIQUE</b> , pinzas para sutura	54
<b>PAULSEN</b> , cánulas irrigación	335
<b>PEAN</b> , pinzas para coger	20
<b>PEAN-DELICATE</b> , pinzas hemostáticas	27
<b>PEAN-ROCHESTER</b> , pinzas hemostáticas	25
<b>PEERS</b> , pinzas de campo	31
<b>PEERS</b> , pinzas para compresas	31
<b>PEET</b> , pinzas para espinas	50
Peine de metal	364
<b>PENNINGTON</b> , instrumentos para la plástica nasal	339
<b>PENNINGTON</b> , pinzas para coger	20
<b>PERWITZSCHKY</b> , tijeras delicadas	74, 275
<b>PETERSEN-SMITH</b> , cinceles	199
<b>PETERSEN-SMITH</b> , gubias	199
<b>PIERCE</b> , instrumentos para la plástica nasal	339
Piezas de conexión	162
<b>PIFFARD</b> , cucharillas cortantes	212
<b>PILCHER</b> , espéculos nasales	312
Pinza de introducción para tubo de ventilación	307
Pinza de presión	307
Pinzas atrauma	55
Pinzas cortantes para amígdalas	255
Pinzas cortantes para endoscopia	396
Pinzas cortantes para huesos	226, 227
Pinzas cortantes para nariz	327-329
Pinzas de aprehensión	43, 44, 397-400
Pinzas de campo	30, 31
Pinzas de disección	34-42
Pinzas de disección con dientes	43, 44, 397-400
Pinzas de disección tungsteno <b>TUC</b>	56-58
Pinzas de fijación	53
Pinzas de ligadura con plataforma	46, 47
Pinzas de relojero	45
Pinzas de reposición	228
Pinzas depilatorias	51
Pinzas hemostáticas	15-32
Pinzas hemostáticas delgadas	27
Pinzas hemostáticas finas	22
Pinzas hemostáticas para pericráneo	28
Pinzas micro	46, 47
Pinzas nasales	52
Pinzas osteótomas	288, 320, 321, 332, 333
Pinzas para agrafes	126
Pinzas para amígdalas	250, 252
Pinzas para catéteres	171
Pinzas para compresas	31
Pinzas para el bocio	246
Pinzas para el tabique nasal y para etmoides	330
Pinzas para enderezar el tabique nasal	355
Pinzas para espinas	48-50
Pinzas para esponjas	130-134
Pinzas para esterilización	364
Pinzas para etmoides y para el tabique nasal	330
Pinzas para la Bi-Coagulación	410
Pinzas para laringo-broncoscopia	267
Pinzas para laringología	272
Pinzas para músculos	246
Pinzas para nariz	327-329
Pinzas para pólipos	131-134, 315
Pinzas para pólipos laríngeos	273
Pinzas para romper hojas	100
Pinzas para seno esfenoidal	332, 333
Pinzas para seno frontal	317
Pinzas para senoscopia	318-327
Pinzas para sutura	53, 54, 126, 127
Pinzas para tapones	131-134

Pinzas para torcer hilos tungsteno <b>TUC</b>	116
Pinzas para tubos	32
Pinzas tungsteno <b>TUC</b>	56-58
Pinzas-gubias	222-225
<b>PITHA</b> , garrote	230
<b>PLESTER</b> , cuchillos	294
<b>PLESTER</b> , micro instrumentos	295
<b>PLESTER</b> , separadores autoestáticos	152
<b>PLESTER</b> , tubos de aspiración	159
Polipótomos	282, 314
<b>POLITZER</b> , agujas para paracentesis	291
<b>POLITZER</b> , bisturios	291
<b>POLITZER</b> , espéculos auriculares	278
<b>POLITZER</b> , insufladores	305
<b>POOLE</b> , tubos de aspiración	158
<b>POOLE-BABY</b> , tubos de aspiración	158
Porta-agujas	102-116
Porta-agujas micro	117-123
Porta-agujas tungsteno <b>TUC</b>	108-119
Porta-agujas, endoscopia	397
Porta-aldodones	154, 155
Portalgaduras para amígdalas	226
<b>POTTS-SMITH</b> , pinzas de disección	40
<b>POTTS-SMITH</b> , pinzas de disección tungsteno <b>TUC</b>	56
<b>PRATT</b> , curetas cortantes	347
<b>PRATT</b> , sondas	154
<b>PRECISA</b> , manómetro para la presión de la sangre	191
<b>PRESBYTERIAN</b> , pinzas para tubos	32
<b>PRINCE</b> , tijeras para amígdalas	72
<b>PROVIDENCE-HOSPITAL</b> , pinzas hemostáticas	23
Pulverizadores	305
Punción/Agujas especiales	156-162
<b>PYE-SMITH (HARRISON)</b> , pinzas para esterilización	364
<b>PYNCHON-ANDREWS</b> , tubos de aspiración	157

**Q**

<b>QUIRE</b> , pinzas auriculares	283
-----------------------------------	-----

**R**

<b>RAGNELL(KILNER)</b> , tijeras para preparaciones	71
<b>RAGNELL-DAVIS</b> , separadores finas	141
<b>RALK</b> , pinzas para espinas	50
<b>RAMPLEY</b> , pinzas para esponjas	134
<b>RANKIN-CRILE</b> , pinzas hemostáticas	24
<b>RANKIN-KELLY</b> , pinzas hemostáticas	24
Raspadores	215, 216, 298
<b>REICHERT</b> , instrumentos para laringología	272
<b>REILL</b> , micro-porta-agujas	120
<b>REINKE-LOPEZ</b> , disecadores	249
Retractores para amígdalas	226
<b>REVERDIN</b> , agujas	124
<b>REYNOLDS</b> , tijeras para preparaciones	72
<b>RICHARDSON(KELLY)</b> , separadores	145
<b>RICHTER</b> , tijeras para cirugía	64
<b>RICHTER-HEATH</b> , pinzas para agrafes	126
<b>RING</b> , abre-bocas	234
<b>RIRAP</b> , estetoscopios	189
<b>RITTER-HALLE</b> , dilatadores para el seno frontal	335
<b>ROCHESTER-PEAN</b> , pinzas hemostáticas	25
<b>RÖDER</b> , portalgaduras para amígdalas	250
<b>ROEDER</b> , pinzas de campo	31
<b>ROEDER</b> , pinzas para compresas	31
<b>ROGER</b> , elevador para tabique	336
<b>ROGGE</b> , pinzas para esterilización	364
<b>ROLLET</b> , ganchos	139
<b>ROSE</b> , separadores para la tráquea	243
<b>ROSEN</b> , agujas auriculares	292, 293
<b>ROSEN</b> , cuchillos	294
<b>ROSEN</b> , micro instrumentos	295
<b>ROSER-KÖNIG</b> , abre-bocas	231



<b>ROUX</b> , separadores	146
<b>ROWE</b> , pinzas de reposición	228
<b>RUBIN</b> , instrumentos para la plástica nasal	356
<b>RUBIN</b> , osteótomos	351
<b>RUSKIN</b> , pinzas-gubias	225
<b>RUSKIN-LISTON</b> , pinzas cortantes para huesos	227
<b>RUSKIN-MINI</b> , pinzas-gubias	225
<b>RUSS.-MODELL</b> , pinzas para coger	44
<b>RYDER/FRENCH-EYE</b> , porta-agujas tungsteno <b>TUC</b>	108
<b>RYDER-LANGENBECK</b> , porta-agujas tungsteno <b>TUC</b>	116
<b>RYDER-MATHIEU VASCULAR</b> , porta-agujas tungsteno <b>TUC</b>	114
<b>RYDER-MATHIEU</b> , porta-agujas tungsteno <b>TUC</b>	114
<b>RYDER-MICRO</b> , porta-agujas tungsteno <b>TUC</b>	108

**S**

<b>SANVENERO</b> , tijeras para preparaciones	71
<b>SAROT</b> , porta-agujas	104
<b>SAROT</b> , porta-agujas tungsteno <b>TUC</b>	111
<b>SAUERBRUCH</b> , separadores	144
<b>SCALP-CONTOUR</b> , separadores autoestáticos	152
<b>SCHAEDEL</b> , pinzas de campo	30
<b>SCHAEDEL</b> , pinzas para compresas	30
<b>SCHÄFER</b> , separadores	358
<b>SCHEDE</b> , cucharillas cortantes	211
<b>SCHEINMANN</b> , pinzas intercambiables	257
<b>SCHINK</b> , dermatomo	99
<b>SCHMEDEN</b> , pinzas cortantes para amígdalas	255
<b>SCHMEDEN</b> , pinzas cortantes para nariz	328
<b>SCHMIDT-MORITZ</b> , abaja-lenguas	238
<b>SCHOEMAKER</b> , tijeras para bocio	73
<b>SCHOENBORN</b> , separadores para la tráquea	242
<b>SCHUKNECHT</b> , cuchillos	294
<b>SCHUHNECHT</b> , instr. p. modelar p. formar prótesis estapedienses	297
<b>SCHUHNECHT</b> , separadores autoestáticos	151
<b>SCHUKNECHT(BARON)</b> , tubos de aspiración	300
<b>SCHUMACHER</b> , pinzas intercambiables	257
<b>SCHWECKENDICK-GOOD</b> , tijeras para amígdalas	72
<b>SEBILEAU</b> , elevadores	216
<b>SECCO</b> , mangos para espejo de boca	268
<b>SEIFFERT</b> , pinzas intercambiables	257
<b>SELECT/ERBE</b> , cables de conexión	406
<b>SEMKEN</b> , pinzas de disección	37, 38
<b>SEMKEN</b> , pinzas de disección tungsteno <b>TUC</b>	56
<b>SENN-GREEN</b> , separadores finas	140
<b>SENNING(SCHWED.MODELL)</b> , porta-agujas	105
<b>SENNING(SCHWED.MODELL)</b> , porta-agujas tungsteno <b>TUC</b>	109
<b>SENN-MILLER</b> , separadores finas	141
<b>SENN-MILLER-BABY</b> , separadores finas	141
Separadores	135-152, 240, 241, 358
Separadores autoestáticos	149-152
Separadores finas	135-141
Separadores para la tráquea	242, 243
Separadores para labios y mejillas	238, 239
Separadores para úvula	226
Separadores con iluminación de luz fría	148
Separadores ópticos	148
<b>SEPTUM</b> , agujas para Septum	335
<b>SEWALL</b> , curetas	347
<b>SHAMBAUGH</b> , ganchitos auriculares	292
<b>SHAMBAUGH-DERLACKI</b> , legras	298
<b>SHAPLEIGH</b> , curetas auriculares	289
<b>SHEA</b> , instrumentos para la platina estapediense	296
<b>SHEEHAN</b> , osteótomos	351
<b>SHORTBENT</b> , tijeras para ligaduras	78
<b>SIEGLE</b> , espéculos auriculares	281
<b>SILVER</b> , dermatomos	100
<b>SILVER</b> , osteótomos	352
<b>SIMPLEX</b> , separadores para mejillas	238
<b>SINUSCOPY</b> , trócares	156
Sistema de contenedor	365-388
<b>SLUDER-BALLENGER</b> , amígdalótomo	253

<b>SMITH-FERRIS</b> , pinzas de disección	42
<b>SMITH-FERRIS</b> , pinzas para seno esfenoidal	333
<b>SMITH-PETERSEN</b> , cinceles	199
<b>SMITH-PETERSEN</b> , gubias	199
<b>SMITH-POTTS</b> , pinzas de disección	40
<b>SMITH-POTTS</b> , pinzas de disección tungsteno <b>TUC</b>	56
<b>SNELLEN</b> , asas auriculares	290
<b>SNITMAN</b> , separadores autoestáticos	149
Sondas	153-155, 274
Sondas exploradoras para ductus salivarius	274
<b>SONNENSCHNEIN</b> , espéculos nasales	312
Soporte contra-pecho para abre-bocas	236
<b>SPENCER</b> , tijeras para ligaduras	77
<b>SPENCER-DELICATE</b> , tijeras para ligaduras	77
<b>SPENCER-WELLS</b> , pinzas hemostáticas	21
<b>SPRATT</b> , cucharillas cortantes	211
<b>ST.BARTHOLOMEW</b> , pinzas para nariz	331
<b>ST.CLAIR-THOMPSON</b> , cuchillos p.vegetaciones adenoides	354
<b>ST.CLAIR-THOMPSON</b> , espejo postrinoscópico	272
<b>ST.MARTIN</b> , pinzas para sutura	53
<b>STACKE</b> , sondas	153
<b>STAMMBERGER</b> , pinzas para sinusopia	324
<b>STANDARD</b> , abaja-lenguas	239
<b>STANDARD</b> , pinzas de disección	34, 35
<b>STANDARD</b> , tijeras para cirugía	62
<b>STANDARD</b> , tijeras tungsteno <b>TUC</b>	86, 87
<b>STELLBRINK</b> , pinzas-gubias	222
<b>STERNBERG</b> , separadores para mejillas y labios	238
<b>STERNUM</b> , pinzas para torcer hilos tungsteno <b>TUC</b>	116
<b>STEVENS</b> , tijeras para tenotomía	77
<b>STEVENS</b> , tijeras tungsteno <b>TUC</b>	92
<b>STIEGLITZ</b> , pinzas para espinas	50
<b>STIERLEN</b> , abaja-lenguas	241
<b>STILLE</b> , cinceles	201
<b>STILLE</b> , gubias	201
<b>STILLE</b> , pinzas de disección	42
<b>STILLE-MAYO</b> , tijeras	65
<b>STILLE-MAYO</b> , tijeras tungsteno <b>TUC</b>	88
<b>STORZ</b> , adaptador	412
<b>STRÜMPFEL</b> , pinzas auriculares	284
<b>STRUYCKEN</b> , pinzas cortantes para nariz	328, 329
<b>STRUYCKEN</b> , pinzas para senoscopia	319
<b>STRYKER</b> , adaptador	412
<b>SULLIVAN(BROPHY)</b> , tijeras finas	75
Super Cut Tijeras	61
Sutura	101-128
<b>SYME</b> , agujas para ligaduras	124

**T**

<b>TABB</b> , cuchillos	294
<b>TAKAHASHI</b> , pinzas cortantes para nariz	329
<b>TAKAHASHI</b> , pinzas para senoscopia	319
<b>TAYLOR</b> , pinzas de disección	38
<b>TAYLOR-CUSHING</b> , pinzas de disección tungsteno <b>TUC</b>	57
<b>TERRIER</b> , pinzas hemostáticas	21
<b>THIESS</b> , martillos	208
<b>THOMPSON-ST.CLAIR</b> , espejo postrinoscópico	272
<b>THOREK</b> , tijeras para preparaciones	70
<b>THUDICHUM(GOLDSMITH)</b> , espéculos nasales	313
<b>TIECK-HALLE</b> , espéculos nasales	311
Tijeras	59-94
Tijeras finas	74-77
Tijeras micro	79-84
Tijeras nasales	73
Tijeras para amígdalas	72
Tijeras para bocio	73
Tijeras para cirugía	62-65
Tijeras para disección de nervios	70
Tijeras para facelift	69
Tijeras para incisión	64
Tijeras para iridectomía	76



	Página		Página
Tijeras para ligaduras	77, 78	<b>WATSON-WILLIAMS</b> , pinzas cortantes para nariz	327
Tijeras para nervios	70	<b>WAUGH</b> , pinzas para coger	43
Tijeras para preparaciones	65-72	<b>WEBSTER</b> , porta-agujas	103
Tijeras Super-cut <b>SC</b>	61	<b>WEBSTER</b> , porta-agujas tungsteno <b>TUC</b>	110
Tijeras tungsteno <b>TUC</b>	85-93	<b>WEERDA</b> , dilatadores	241
Tijeras, endoscopia	396	<b>WEIL-BLAKESLEY</b> , pinzas cortantes para nariz	327
<b>TILLEY</b> , pinzas auriculares	283	<b>WEIL-BLAKESLEY</b> , pinzas para senoscopia	318, 319
<b>TIVNEN</b> , pinzas para las amígdalas	252	<b>WEINGÄRTNER</b> , pinzas auriculares	284
<b>TOBOLD</b> , abaja-lenguas	238	<b>WEITLANER</b> , separadores autoestáticos	150
<b>TOENNIS</b> , porta-agujas	107	<b>WEITLANER-BABY</b> , separadores autoestáticos	150
<b>TOENNIS</b> , porta-agujas tungsteno <b>TUC</b>	115	<b>WELLS-SPENCER</b> , pinzas hemostáticas	21
<b>TOENNIS-ADSON-DELICATE</b> , tijeras tungsteno <b>TUC</b>	93	<b>WEST</b> , cinceles	348
<b>TOHOKU-JAPAN</b> , pinzas de campo	31	<b>WEST</b> , gubias	348
<b>TOHOKU-JAPAN</b> , pinzas para compresas	31	<b>WESTMACOTT</b> , pinzas para pólipos	315
<b>TOYNBEE</b> , espéculos auriculares	278	<b>WHITE</b> , pinzas para amígdalas	252
Traqueótomos	241	<b>WHITEHEAD</b> , abre-bocas	232
<b>TRELAT</b> , elevador periósteo	336	<b>WIEDER</b> , abaja-lenguas	238
<b>TREPSAT</b> , tijeras para face-lift	69	<b>WIENER</b> , escofinas nasal	341
Trocars	156, 241	<b>WILDE(TROELTSCH)</b> , pinzas auriculares	52
<b>TROELTSCH(WILDE)</b> , pinzas auriculares	52	<b>WILDE-LANGE</b> , polipótomos	282, 314
<b>TROUSSEAU</b> , dilatadores	241	<b>WILDER</b> , dilatadores para ductus salivarius	275
<b>TROUTMAN-CHRIS</b> , pinzas para romper hojas	100	<b>WILLIAMS-WATSON</b> , pinzas cortantes para nariz	327
Tubes de ventilation	307	<b>WILLIGER</b> , cucharillas cortantes	214
<b>TÜBINGER MODELL</b> , separadores	152	<b>WILLIGER</b> , elevadores	216
<b>TÜBINGER</b> , tubes de ventilation	307	<b>WILLIGER</b> , martillos	207
Tubos de aspiración	157-160, 300, 301	<b>WILLIGER</b> , raspadores	216
<b>TUFFIER</b> , pinzas para coger	20	<b>WILMER</b> , tijeras para iridectomía	76
<b>TYDING</b> , cierra-nudos para amígdalas	254	<b>WINTER + IBE</b> , adaptador	412
<b>TYDING</b> , pinzas para las amígdalas	252	<b>WISCONSIN(FOREGGER)</b> , fibre optic laringoscopios	168
<b>U</b>			
<b>UCKERMANN</b> , porta-algodones	155	<b>WISCONSIN(FOREGGER)</b> , laringoscopios	164
<b>UCKERMANN</b> , traqueótomos	241	<b>WOLF/HENKE-SASS</b> , adaptador	412
<b>UFFENORDE</b> , curetas cortantes	348	<b>WULLSTEIN MICRO</b> , tubos de aspiración	159
<b>UNI OTOSKOP</b> , juegos para diagnóstico	193	<b>WULLSTEIN</b> , cuchillos	294
<b>UNI-ECONOM</b> , juegos para diagnóstico	192	<b>WULLSTEIN</b> , elevadores	298
<b>UNIV.MINNESOTA</b> , abaja-lenguas	239	<b>WULLSTEIN</b> , micro pinzas auriculares	288
<b>UNIVERSAL</b> , pinzas-gubias	222	<b>WULLSTEIN</b> , separadores autoestáticos	151
<b>V</b>			
<b>VALLEYLAB</b> , cables de conexión	406	<b>WULLSTEIN</b> , tubos de aspiración	300
<b>VALLEYLAB</b> , mangos porta-electrodos con cable fijo	405	<b>WULLSTEIN-HARTMANN</b> , pinzas auriculares	284
<b>VASCULAR MATHIEU-RYDER</b> , porta-agujas tungsteno <b>TUC</b>	114	<b>WÜRZBURG</b> , disecadores	249
<b>VERHOEVEN</b> , tubos de aspiración	301	<b>Y</b>	
Video-Otoscopio	194	<b>YANKAUER</b> , espéculos nasales	312
<b>WISE</b> , pinzas de ligadura con plataforma	46	<b>YANKAUER</b> , tubos de aspiración	157
<b>VOLKMANN</b> , cucharillas cortantes	210, 214	<b>YANKAUER-WALTON</b> , tubos de aspiración	157
<b>VOLKMANN</b> , separadores	142	<b>YOUNG</b> , pinzas tira-lengua	240
<b>VOLTOLINI(DUPLAY)</b> , espéculos nasales	313	<b>Z</b>	
<b>VOSS-KRAUSE</b> , polipótomos	282, 314	<b>ZAUFAL</b> , ganchitos auriculares	290
<b>W</b>			
<b>WACHENFELDT</b> , pinzas para agrafes	126	<b>ZAUFAL-JANSEN</b> , pinzas-gubias	225
<b>WAGENER</b> , ganchitos auriculares	290	<b>ZIEGLER</b> , pinzas depilatorias	51
<b>WAGENER-MOSHER</b> , bocio	243	<b>ZÖLLNER</b> , tubos de aspiración	300
<b>WAGNER</b> , tijeras finas	74	Zoom-adaptador	413
<b>WALSHAM</b> , pinzas para enderezar el tabique nasal	355		
<b>WALTER(AUFRICHT)</b> , instrumentos para la plástica nasal	346		
<b>WALTER</b> , cinceles	351		
<b>WALTER</b> , osteótomos	351		
<b>WALTER</b> , separadores finas	141		
<b>WALTON</b> , tijeras finas	76		
<b>WALTON-LISTON</b> , pinzas cortantes para huesos	227		
<b>WALTON-YANKAUER</b> , tubos de aspiración	157		
<b>WANGENSTEEN</b> , pinzas de disección tungsteno <b>TUC</b>	58		
<b>WARTENBERG</b> , instrumentos sensibilidad	188		
<b>WATSON</b> , dermatomo	99		





# Index

	Page		Page
<b>A</b>			
Abaisse-langues	238, 239	<b>BALL &amp; SOCKET</b> , pinces à champs	31
<b>ABRAHAM</b> , bistouris pour amygdales	247	<b>BALLENGER</b> , bistouris pour la cloison nasale	336
Accessoires pour (laser) laryngoscopes opératoires	177, 179, 180	<b>BALLENGER</b> , élévateur pour cloison	336
<b>ACM/HEINE</b> , connexion	412	<b>BALLENGER</b> , gouges	348
Adénotomes	354	<b>BALLENGER</b> , pinces pour amygdales	252
<b>ADLERKREUTZ</b> , pinces à griffes	42	<b>BALLENGER-FOERSTER</b> , pinces à éponges	133, 134
<b>ADSON</b> , canules d'aspiration	160	<b>BALLENGER-SLUDER</b> , amygdalotome	253
<b>ADSON</b> , pinces à dissection et à griffes	36, 37	<b>BARBARA</b> , aiguilles auriculaires	292, 293
<b>ADSON</b> , pinces à dissection tungstène <b>TUC</b>	57	<b>BARBON-LUBET</b> , pinces à polypes nasaux	315
<b>ADSON</b> , porte-aiguilles	105	<b>BARNHILL</b> , couteaux à végétations adénoïdes	353
<b>ADSON-BABY</b> , écarteurs autostatiques	152	<b>BARON(SCHUKNECHT)</b> , canules d'aspiration	300
<b>ADSON-BROWN</b> , pinces à griffes	37	<b>BARSKY</b> , instruments pour la plastique nasale	346
<b>ADSON-MICRO</b> , pinces à dissection et à griffes	36	<b>BARTH</b> , cuillers auriculaires	289
<b>ADSON-TOENNIS-DELICATE</b> , ciseaux tungstène <b>TUC</b>	93	Bassins réniformes	360
<b>ADVENTITIA</b> , micro-ciseaux	80, 82	<b>BAUMGARTNER</b> , porte-aiguilles	105
Affectations, easyClean	396-399	<b>BEALES</b> , élévateurs	299
Agrafes	127	<b>BECKMANN(NEGUS)</b> , couteaux à végétations adénoïdes	353
Aiguilles à ligatures	124, 125	<b>BECKMANN</b> , couteaux à végétations adénoïdes	353
Aiguilles à paracentèse	291	<b>BECKMANN</b> , spéculums nasaux	311
Aiguilles auriculaires	292, 293	<b>BEER</b> , pinces à épiler les cils	51
Aiguilles de Reverdin	124	<b>BELLUCCI</b> , micro pinces auriculaires	287
Aiguilles per amygdales	251	<b>BERCHTOLD/MARTIN</b> , câbles de raccordement	406
Aiguilles pour Septum	335	<b>BERCHTOLD/MARTIN</b> , manches porte-électrodes	404
Aiguilles spéciales	156-162	<b>BERCHTOLD/MARTIN</b> , manches porte-électrodes avec câble	405
<b>ALDERDYCE</b> , élévateurs	217	<b>BERNHARD</b> , pinces à champs	30
<b>ALEXANDER</b> , ciseaux-burins	198	<b>BEYER</b> , pinces ostéotomes	288
<b>ALLIGATOR</b> , pinces à polypes laryngiens	273	<b>BEYER</b> , pinces-gouges	225
<b>ALLIS</b> , pinces à préhension	398	<b>BILLEAU</b> , anses auriculaires	290
<b>ALLIS</b> , pinces pour saisir le tissu	17	Biopsie	396
<b>ALM</b> , écarteurs autostatiques	149	Bistouris pour amygdales	247
<b>ALY</b> , instruments sensibilité	188	Bistouris pour cloison	336
Amygdalotomes	253	Bistouris pour la cloison nasale	336
<b>ANDERSON-NEIVERT</b> , ostéotomes	352	Bistouris pour opérations du nez	334
<b>ANDREWS-PYNCHON</b> , canules d'aspiration	157	<b>BLOHMKE</b> , pinces pour amygdales	252
Anesthésie	163-180	<b>BLUMENTHAL</b> , pinces-gouges	223
Anses	290	<b>BÖHLER</b> , pinces-gouges	225
Anses auriculaires	290	<b>BOIES</b> , instruments pour la plastique nasale	355
<b>ARRUGA</b> , porte-aiguilles	102	Boîtes	360, 363
<b>ARRUGA</b> , porte-aiguilles tungstène <b>TUC</b>	115	Boîtes pour instruments	363
Articles divers	381-388	Boîtes pour stériliser des aiguilles	361
<b>ASCH</b> , pinces pour la cloison nasale	355	<b>BOLGER-KUHN</b> , curettes tranchantes	347
<b>AUFRICHT GLABELLA</b> , râpes nasale	340	<b>BONACCOLTO</b> , pinces pour sutures	54
<b>AUFRICHT(WALTER)</b> , instruments pour la plastique nasale	346	<b>BONNEY</b> , pinces à dissection tungstène <b>TUC</b>	58
<b>AUFRICHT</b> , élévateur pour périoste	336	<b>BOSE</b> , dilateurs	241
<b>AUFRICHT</b> , instruments pour la plastique nasale	346	<b>BOSE</b> , écarteurs pour trachéotomie	242
<b>AUFRICHT</b> , râpes nasale	340	<b>BÖTTCHER</b> , ciseaux pour les amygdales	72
<b>AUSTIN</b> , pinces à ligatures avec plate-forme	46	<b>BOUCHERON</b> , spéculums auriculaires	279
<b>B</b>			
<b>BABCOCK</b> , pinces à préhension	399	<b>BOWMAN</b> , sondes exploratrices pour le ductus salivarius	274
<b>BABCOCK</b> , pinces pour saisir l'intestin	17	<b>BOYLE-DAVIS</b> , ouvre-bouches	233
<b>BABY-ADSON</b> , ecarteurs autostatiques	152	<b>BOYNTON</b> , porte-aiguilles	102
<b>BABY-CRILE-WOOD</b> , porte-aiguilles	104	<b>BOYNTON</b> , porte-aiguilles tungstène <b>TUC</b>	115
<b>BABY-CRILE-WOOD</b> , porte-aiguilles tungstène <b>TUC</b>	111	<b>BRODIE</b> , sondes	154
<b>BABY-LEXER</b> , ciseaux à dissection	71	<b>BROPHY(SULLIVAN)</b> , ciseaux fins	75
<b>BABY-MILLER-SENN</b> , écarteurs fins	141	<b>BROPHY</b> , pinces à dissection et à griffes	40
<b>BABY-MIXTER</b> , pinces à dissection et à ligatures	29	<b>BROWN</b> , pinces à griffes	41
<b>BABY-POOLE</b> , canules d'aspiration	158	<b>BROWN-ADSON</b> , pinces à griffes	37
<b>BABY-SENN-MILLER</b> , écarteurs fins	141	<b>BRUENINGS</b> , abaisse-langues	239
<b>BABY-WEITLANER</b> , ecarteurs autostatiques	150	<b>BRUENINGS</b> , bistouris pour amygdales	247
<b>BABY-WEITLANER</b> , écarteurs autostatiques	150	<b>BRUENINGS</b> , pinces ethmoidales et pour la cloison nasale	330
<b>BACKHAUS</b> , pinces à champs	31	<b>BRUENINGS</b> , pinces interchangeables	256, 257
<b>BACON</b> , pinces-gouges	224	<b>BRUENINGS</b> , serre-noeuds pour l'ablation des amygdales	254
Baïllons	230, 237	<b>BRUENINGS</b> , spéculums auriculaires	280
<b>BAINBRIDGE</b> , pinces hémostatiques	28	<b>BRUENINGS-BRUNK</b> , ecarteurs	358
		<b>BRUNS</b> , curettes tranchantes	210, 213
		<b>BRYANT</b> , pinces à éponges	130
		<b>BUCK</b> , ciseaux à ligatures	78
		<b>BUCK</b> , curettes auriculaires	289
		<b>BUCK</b> , pinces auriculaires	283

	Page		Page
<b>BUCKINGHAM</b> , instruments pour chirurgie de l'étrier	296	<b>CONE</b> , écarteurs autostatiques	152
Bulldog clamps	18, 19	Connexion	412
<b>C</b>		Conteneur 1/1	376-380
Câble fibre optique	411	Conteneur 1/2	368-371
Câbles de raccordement	406, 407	Conteneur 3/4	371-375
<b>CAIRNS</b> , pinces hémostatiques	27	Conteneur, endoscopie	385-387
<b>CANFIELD</b> , bistouris pour amygdales	247	<b>CONVERSE</b> , bistouris pour opérations du nez	334
Canule pour amygdales	253	<b>CONVERSE</b> , ciseaux-burins	352
Canules à irrigation	335	<b>CONVERSE</b> , crochets très fins	345
Canules d'aspiration	157-160, 300, 301	<b>CONVERSE</b> , instruments pour la plastique nasale	346
Canules pour trachéotomie	244	<b>CONVERSE</b> , porte-aiguilles tungstène <b>TUC</b>	110
<b>CAPLAN</b> , ciseaux nasaux	73	<b>CONVERSE-DERF</b> , porte-aiguilles	102
<b>CARDIFF</b> , spéculums nasaux	312	<b>CORDES</b> , pinces interchangeable	257
<b>CARDIOPHON</b> , stéthoscopes	190	<b>CORWIN</b> , pinces à torsader le fil tungstène <b>TUC</b>	116
<b>CARPENTER</b> , bistouris pour amygdales	247	<b>COTTLE KAZANJIAN</b> , pinces coupantes à os	226
<b>CARREL</b> , pinces hémostatiques	21	<b>COTTLE(MILLARD)</b> , crochets très fins	345
<b>CARROLL</b> , porte-aiguilles	104	<b>COTTLE</b> , bistouris pour opérations du nez	334
<b>CARROLL</b> , porte-aiguilles tungstène <b>TUC</b>	109	<b>COTTLE</b> , ciseaux nasaux	73
<b>CARTER</b> , élévateur pour cloison	336	<b>COTTLE</b> , ciseaux-burins	349
<b>CASTROVIEJO</b> , micro-porte-aiguilles tungstène <b>TUC</b>	117	<b>COTTLE</b> , crochets très fins	344, 345
<b>CASTROVIEJO</b> , pinces pour sutures	53	<b>COTTLE</b> , élévateurs	338
<b>CASTROVIEJO</b> , pincettes pour casser les lames	100	<b>COTTLE</b> , instruments pour la plastique nasale	346
<b>CHADWICK</b> , ciseaux oculaires	77	<b>COTTLE</b> , marteaux	207, 302, 357
<b>CHAPUT</b> , pinces à saisir	20	<b>COTTLE</b> , ostéotomes	349
<b>CHEATLE</b> , pinces à stérilisation	364	<b>COTTLE</b> , pince pour columelle	346
<b>CHEVALIER-JACKSON</b> , canules pour trachéotomie	244	<b>COTTLE</b> , pinces nasales	52
<b>CHILDE</b> , pinces pour agrafes	127	<b>COTTLE</b> , presse pour matière cartilagineuse	356
<b>CHRIS-TROUTMAN</b> , pincettes pour casser les lames	100	<b>COTTLE</b> , râpes nasale	340, 343
<b>CINELLI</b> , ciseaux-burins	34	<b>COTTLE</b> , spéculums nasaux	313
Ciseaux à chirurgie	62-65	<b>COTTLE-NEIVERT</b> , crochets très fins	345
Ciseaux à dissection	65-72	<b>COUPLAND</b> , canules d'aspiration	158
Ciseaux à facelift	69	Couteaux à végétations adénoïdes	353, 354
Ciseaux à goitre	73	<b>CRAIG</b> , pinces ethmoïdales et pour la cloison nasale	330
Ciseaux à incision	64	<b>CRILE</b> , pinces hémostatiques	24
Ciseaux à iridectomie	76	<b>CRILE</b> , porte-aiguilles	107
Ciseaux à préparation	65-72	<b>CRILE-MURRAY</b> , porte-aiguilles	104
Ciseaux fins	74-77	<b>CRILE-RANKIN</b> , pinces hémostatiques	24
Ciseaux micro	79-84	<b>CRILE-WOOD</b> , porte-aiguilles	104
Ciseaux nasaux	73	<b>CRILE-WOOD</b> , porte-aiguilles tungstène <b>TUC</b>	111
Ciseaux oculaires	77, 78	<b>CRILE-WOOD-BABY</b> , porte-aiguilles	104
Ciseaux pour les amygdales	72	<b>CRILE-WOOD-BABY</b> , porte-aiguilles tungstène <b>TUC</b>	111
Ciseaux pour nerfs	70	Crochets	290
Ciseaux super cut <b>SC</b>	61	Crochets auriculaires	290, 292, 293
Ciseaux tungstène <b>TUC</b>	85-93	Crochets très fins	135-141, 344, 345
Ciseaux, endoscopie	396	<b>CRURA-NIPPER</b> , micro pinces auriculaires	286
Ciseaux-burins	348-352	Cuillère	289, 347, 348
Ciseaux-burins et Ostéotomes	348-352	Cuillers auriculaires	289
<b>CITELLI</b> , pinces ostéotomes	288	Curettes	210-214, 289, 298, 347, 348
Clamps bulldog	18, 19	Curettes auriculaires	289, 298, 299
<b>CLAR 55</b> , éclairateurs frontaux	182	Curettes tranchantes	210-214
<b>CLAR STANDARD</b> , éclairateurs frontaux	182	<b>CUSHING</b> , crochets très fins	137
<b>CLAUS-HAJEK</b> , pinces pour sinus sphénoïdal	333	<b>CUSHING</b> , pinces à dissection et à griffes	39
<b>CLAUS-KILLIAN</b> , gouges	348	<b>CUSHING</b> , pinces à dissection tungstène <b>TUC</b>	57
<b>CLEVELAND</b> , pinces coupantes à os	227	<b>CUSHING-TAYLOR</b> , pinces à dissection tungstène <b>TUC</b>	57
<b>CLEVELAND</b> , pinces-gouges	222	<b>D</b>	
<b>CLEVELAND-GARDNER</b> , pinces coupantes à os	226	<b>DAHMEN</b> , ciseaux-burins	205
Clips de stérilisation	364	<b>DAHMEN</b> , ostéotomes	205
<b>CLOWARD</b> , curettes tranchantes	213	<b>DANDY</b> , pinces hémostatiques pour le cuir chevelu	28
<b>COAKLEY</b> , curettes	347	<b>DAVIS-BOYLE</b> , ouvre-bouches	233
<b>COBB</b> , ciseaux-burins	204	<b>DAVIS-MAYER</b> , ouvre-bouches	235
<b>COLBURN-MILLER</b> , râpes nasale	342	<b>DAVIS-RAGNELL</b> , crochets très fins	141
<b>COLLER</b> , pinces hémostatiques	24	<b>DAVIS-RAGNELL</b> , écarteurs fins	141
<b>COLLIER</b> , porte-aiguilles	102	<b>DE BAKEY</b> , canules d'aspiration	157
<b>COLLIN</b> , manches pour bistouris	97	<b>DE BAKEY</b> , pinces à dissection tungstène <b>TUC</b>	58
<b>COLLIN</b> , marteaux	207	<b>DE BAKEY</b> , pinces à préhension	398
<b>COLLIN</b> , pinces pour agrafes	126	<b>DE BAKEY</b> , pinces atrauma	55
<b>COLLIN</b> , pinces tire-langue	240	<b>DE BAKEY</b> , porte-aiguilles tungstène <b>TUC</b>	108
<b>COLLIN-DUVAL</b> , pinces pour saisir les tissus	43	<b>DE LA ROZA</b> , aiguilles à ligatures	125
<b>COLLIN-HARTMANN</b> , écarteurs	146	<b>DEAVER</b> , ciseaux à chirurgie	64
<b>COLVER</b> , pinces pour amygdales	252	<b>DELICATE-LANGENBECK</b> , porte-aiguilles tungstène <b>TUC</b>	73

	Page		Page
<b>DELICATE-MATHIEU</b> , porte-aiguilles	106	Endoscopie	399-413
<b>DELICATE-MAYO-HEGAR</b> , porte-aiguilles	105	<b>ENGL. MODELL</b> , pinces à champs	30
<b>DELICATE-MAYO-HEGAR</b> , porte-aiguilles tungstène <b>TUC</b>	108	<b>ERBE</b> (U.S.), manches porte-électrodes avec câble	405
<b>DELICATE-METZENBAUM</b> , ciseaux à dissection	68	<b>ERBE</b> , câbles de raccordement	406
<b>DELICATE-METZENBAUM</b> , ciseaux tungstène <b>TUC</b>	90, 91	<b>ERBE</b> , manches porte-électrodes	404
<b>DELICATE-TOENNIS-ADSON</b> , ciseaux tungstène <b>TUC</b>	93	<b>ERBE/SELECT</b> , câbles de raccordement	406
<b>DENHART</b> , ouvre-bouches	231	<b>EUFRATE-PASQUÉ</b> , porte-aiguilles tungstène <b>TUC</b>	109
<b>DERF</b> , porte-aiguilles	102	<b>EVES</b> , serre-noeuds pour l'ablation des amygdales	254
<b>DERF</b> , porte-aiguilles tungstène <b>TUC</b>	110	<b>EWALD</b> , pinces à dissection et à griffes	37
<b>DERF-CONVERSE</b> , porte-aiguilles	102		
<b>DERLACKI-SHAMBAUGH</b> , rugines	298	<b>F</b>	
Dermatomes	99, 100	Face-Lift dissecteurs	218-221
<b>DESMARRES</b> , crochets très fins	141	<b>FARABEUF</b> , écarteurs	147
Diagnostic	181-194	<b>FARRELL</b> , porte-coton	154
Diapasons	303, 304	<b>FARRIOR</b> , spéculums auriculaires	279
<b>DIEFFENBACH</b> , clamps bulldog	19	<b>FAULKNER</b> , curettes	347
<b>DIETER</b> , micro pinces auriculaires	287	<b>FEILCHENFELD</b> , pinces à échardes	48
<b>DIETRICH</b> , micro-porte-aiguilles tungstène <b>TUC</b>	117	<b>FEIN</b> , porte-coton	155
Dilatateurs	241	<b>FERGUSSON</b> , canules d'aspiration	159
Dilatateurs pour le ductus salivarius	275	<b>FERRERIRA</b> , écarteurs	148
Dilatateurs pour le sinus frontal	335	<b>FERRIS-SMITH</b> , pinces à griffes	42
Dilatateurs vasculaires	47	<b>FERRIS-SMITH</b> , pinces pour sinus sphénoïdal	333
Dimensions diverses et accessoires	359-364	<b>FINSEN</b> , écarteurs autostatiques	149
<b>DINGMANN</b> , ouvre-bouches	233	<b>FISCH</b> , crochet pour platine de l'étrier	297
Dissecteurs	248-250, 307	<b>FISCH</b> , dissecteurs	295
Dissecteurs, face-Lift	218-221	<b>FISCHER</b> , bistouris pour amygdales	247
Dissection émoussée	397	<b>FOERSTER-BALLENGER</b> , pinces à éponges	133, 134
Dissection tranchant	396, 400	<b>FOMON</b> , bistouris pour opérations du nez	334
<b>DISSECTION</b> , micro-ciseaux	80, 82	<b>FOMON</b> , ciseaux à dissection	70
<b>DIXON-LOVELACE</b> , pinces hémostatiques	28	<b>FOMON</b> , ciseaux nasaux	73
Doigtiers	230	<b>FOMON</b> , ciseaux-burins	351
<b>DOLPHIN</b> , dissection émoussée	397, 400	<b>FOMON</b> , crochets très fins	344
<b>DOUGHTY-KILNER</b> , ouvre-bouches	232	<b>FOMON</b> , râpes nasale	341, 343
<b>DOUGLAS</b> , bistouris pour amygdales	247	<b>FOREGGER(WISCONSIN)</b> , fibre optic laryngoscopes	168
<b>DOUGLAS</b> , pinces à épiler les cils	51	<b>FOREGGER(WISCONSIN)</b> , laryngoscopes	164
<b>DOYEN</b> , abaisse-langues	239	<b>FOX</b> , curettes tranchantes	212
<b>DOYEN</b> , pinces à champs	30	<b>FOX-GOLDMAN</b> , ciseaux tungstène <b>TUC</b>	93
<b>DOYEN</b> , porte-aiguilles	102	<b>FRAENKEL</b> , pinces à polypes laryngiens	272, 273
<b>DOYEN</b> , sondes	153	<b>FRAENKEL</b> , pinces interchangeable	257
<b>DRAFFIN</b> , support de poitrine bipod	236	<b>FRAZIER</b> , canules d'aspiration	159
<b>DUCKBILL</b> , pinces auriculaires	284	<b>FRAZIER</b> , crochets très fins	135
<b>DUEHRSSSEN</b> , pinces à dissection	41	<b>FREEMAN-GORNEY</b> , ciseaux à face-lift	69
<b>DUNHILL</b> , pinces hémostatiques	27	<b>FREER</b> , bistouris pour opérations du nez	339
<b>DUPLAY(VOLTOLINI)</b> , spéculums nasaux	313	<b>FREER</b> , ciseaux-burins	348
<b>DUPLAY</b> , pinces à pansements	133	<b>FREER</b> , crochets très fins	344
<b>DUPLEX</b> , stéthoscopes	190	<b>FREER</b> , élévateur aspirant	335
<b>DUPUY WEISS</b> , aiguilles per amygdales	251	<b>FREER</b> , élévateurs	217, 337
<b>DURANTE</b> , pinces pour saisir les tissus	44	<b>FREER</b> , gouges	348
<b>DUVAL</b> , pinces pour saisir les tissus	44	<b>FREER</b> , instruments pour rhinoplastie	334
<b>DUVAL-COLLIN</b> , pinces pour saisir les tissus	43	<b>FRENCH-EYE/Ryder</b> , porte-aiguilles tungstène <b>TUC</b>	108
		<b>FRENCH-HARTMANN</b> , diapasons	303
<b>E</b>		<b>FRENZEL</b> , abaisse-langues	239
easyClean	394-399	<b>FRIEDMAN</b> , pinces-gouges	222
Ecarteurs	135-152, 240, 241, 358	<b>FULLER</b> , micro pinces auriculaires	287
Ecarteurs autostatiques	149-152		
Ecarteurs avec illumination à lumière froide	148	<b>G</b>	
Ecarteurs des joues et des lèvres	238, 239	<b>GALLAGHER</b> , râpes nasale	340
Ecarteurs fins	135-141	<b>GARDNER-CLEVELAND</b> , pinces coupantes à os	226
Ecarteurs optiques	148	<b>GELFOAM-HOUSE</b> , pince compressive	307
Ecarteurs pour trachéotomie	242, 243	<b>GEMINI</b> , pinces à dissection et à ligatures	29
Ecarteurs pour uvule	226	<b>GERALD</b> , pinces à dissection et à griffes	39
Eclaireurs frontaux	181-185	<b>GILLIES</b> , crochets très fins	135
<b>ECONOM</b> , trousses à diagnostic	192	<b>GILLIES</b> , pinces à dissection tungstène <b>TUC</b>	56
<b>EICKEN-KILLIAN</b> , canules d'aspiration	159	<b>GILLIES</b> , pinces à griffes	43
Electrodes	408, 409	<b>GILLIES</b> , porte-aiguilles	106
Élévateur aspirant	335	<b>GILLIES</b> , porte-aiguilles tungstène <b>TUC</b>	113
Élévateurs	216, 217, 298, 299	<b>GLASSMANN</b> , pinces à préhension	398
Élévateurs des amygdales	226	<b>GOLDMAN-FOX</b> , ciseaux tungstène <b>TUC</b>	93
Élévateurs pour la cloison nasale	336-338	<b>GOLDMANN</b> , instruments pour la plastique nasale	355
Endolaryngéal micro-chirurgie	259-266	<b>GOLDSMITH(THUDICHUM)</b> , spéculums nasaux	313
Endoscopes	401, 402		

<b>GOOD</b> , ciseaux pour les amygdales	72	<b>HF</b> -instruments et accessoires	407-410
<b>GOOD-SCHWECKENDICK</b> , ciseaux pour les amygdales	72	<b>HIBBS SPRATT</b> , curettes tranchantes	213
<b>GORNEY</b> , ciseaux à dissection	70	<b>HIBBS</b> , ciseaux-burins	200
<b>GORNEY</b> , élévateur aspirant	335	<b>HIBBS</b> , ostéotomes	200
<b>GORNEY-FREEMAN</b> , ciseaux à face-lift	69	<b>HILGER</b> , miroirs à bouche	269
Gouges	197-206, 299, 348	<b>HOEN</b> , élévateurs	217
<b>GRAEFE</b> , crochets très fins	136	<b>HOFER</b> , élévateurs des amygdales	251
<b>GRAZIL</b> , ciseaux à chirurgie	63	<b>HOKE</b> , ostéotomes	197
<b>GREEN-SENN</b> , écarteurs fins	140	<b>HOLINGER</b> , laryngoscopes	178
<b>GROSS</b> , crochets auriculaires	290	<b>HOPKINS-JOHNS</b> , clamps bulldog	19
<b>GROSS-MAIER</b> , pinces à pansements	131, 132	<b>HOPKINS-JOHNS</b> , pinces à poser	19
<b>GRUBER</b> , spéculums auriculaires	278	<b>HORNE-JOBSON</b> , porte-coton	155
<b>GRUENWALD (JANSEN)</b> , pinces nasales	52	<b>HOSPITAL-PROVIDENCE</b> , pinces hémostatiques	23
<b>GUEDEL</b> , canules pour trachéotomie	244	<b>HOUSE</b> , canules d'aspiration	300
<b>GUILLEN</b> , canules à irrigation	335	<b>HOUSE</b> , instruments pour chirurgie de l'étrier	296
<b>GUTHRIE</b> , crochets très fins	139	<b>HOUSE</b> , micro instruments	295
<b>GWYNNE</b> , dissecteurs	250	<b>HOUSE-GELFOAM</b> , pince compressive	307
<b>H</b>		<b>HOWARTH</b> , élévateurs	338
<b>HAJEK</b> , marteaux	302	<b>HUBER</b> , manches universels	256
<b>HAJEK-CLAUS</b> , pinces pour sinus sphénoïdal	333	<b>HUMBY</b> , dermatome	99
<b>HAJEK-KOFFLER</b> , pinces pour sinus sphénoïdal	332	<b>HUMBY</b> , instruments pour la plastique nasale	346
<b>HALLE</b> , ciseaux nasaux	73	<b>HUNTER</b> , pinces à échardes	48
<b>HALLE</b> , curettes tranchantes	348	<b>HUNTER</b> , pinces à préhension	399
<b>HALLE</b> , élévateurs	337	<b>HUPP</b> , écarteurs pour trachéotomie	243
<b>HALLE</b> , élévateurs	337	<b>HURD</b> , dissecteurs	248
<b>HALLE-HARTMANN</b> , spéculums nasaux	311	<b>I</b>	
<b>HALLE-RITTER</b> , dilataateurs pour le sinus frontal	335	Illumination à lumière froide	346
<b>HALLE-TIECK</b> , spéculums nasaux	311	Instrument de suture	107
<b>HALSEY</b> , porte-aiguilles	103	Instrument d'introduction pour drain tympanique	307
<b>HALSEY</b> , porte-aiguilles tungstène <b>TUC</b>	110	Instruments pour amygdalotomie	226
<b>HALSTED</b> , pinces hémostatiques	22	Instruments pour chirurgie de l'étrier	296, 297
<b>HALSTED-MOSQUITO</b> , pinces hémostatiques	22	Instruments pour la plastique nasale	339, 346, 356
<b>HARMS</b> , pinces pour sutures	54	Instruments sensibilités	188
<b>HARRISON (PYE-SMITH)</b> , pinces à stérilisation	364	Insufflateurs	305
<b>HARTMANN</b> , abaisse-langues	238	<b>ITERTSON</b> , écarteurs pour trachéotomie	242
<b>HARTMANN</b> , canules d'aspiration	302	<b>J</b>	
<b>HARTMANN</b> , crochets auriculaires	290	<b>JACKSON</b> , écarteurs pour trachéotomie	243
<b>HARTMANN</b> , diapasons	303	<b>JACKSON</b> , laryngoscopes à Lumière foie	178
<b>HARTMANN</b> , pinces à polypes nasaux	315	<b>JACKSON-CHEVALIER</b> , canules pour trachéotomie	244
<b>HARTMANN</b> , pinces auriculaires	283, 284	<b>JACOBI</b> , aiguilles à ligatures	125
<b>HARTMANN</b> , pinces coupantes pour le nez	328	<b>JACOBSON</b> , porte-aiguilles tungstène <b>TUC</b>	109
<b>HARTMANN</b> , pinces emporte-pièces pour amygdales	255	<b>JALASVIRTA</b> , pinces auriculaires	52
<b>HARTMANN</b> , pinces hémostatiques	21	<b>JANET</b> , seringues	161
<b>HARTMANN</b> , pinces-gouges	223	<b>JANSEN (GRUENDWALD)</b> , pinces nasales	52
<b>HARTMANN</b> , spéculums auriculaires	278	<b>JANSEN</b> , cuillers auriculaires	289
<b>HARTMANN</b> , spéculums nasaux	311	<b>JANSEN</b> , curettes tranchantes	214
<b>HARTMANN-COLLIN</b> , écarteurs	146	<b>JANSEN</b> , écarteurs autostatiques	149
<b>HARTMANN-FRENCH</b> , diapasons	303	<b>JANSEN</b> , élévateurs	299
<b>HARTMANN-HALLE</b> , spéculums nasaux	311	<b>JANSEN</b> , pinces nasales	52
<b>HARTMANN-HOFFMANN</b> , pinces auriculaires	284	<b>JANSEN-MIDDLETON</b> , pinces coupantes pour le nez	329
<b>HARTMANN-NOYES</b> , pinces auriculaires	284	<b>JANSEN-ZAUFAL</b> , pinces-gouges	225
<b>HARTMANN-WULLSTEIN</b> , pinces auriculaires	284	<b>JAPAN-TOHOKU</b> , pinces à champs	31
<b>HEATH-RICHTER</b> , pinces pour agrafes	126	<b>JATHO</b> , pinces pour le nez	331
<b>HEERMANN</b> , instruments pour chirurgie de l'étrier	297	<b>JENNINGS</b> , ouvre-bouches	231
<b>HEGAR-MAYO</b> , porte-aiguilles	105	Jeu d'instruments pour trachéotomie	245
<b>HEGAR-MAYO</b> , porte-aiguilles tungstène <b>TUC</b>	108	<b>JEWELER</b> , pinces à dissection tungstène <b>TUC</b>	56
<b>HEGAR-MAYO-DELICATE</b> , porte-aiguilles	105	<b>JOBSON-HORNE</b> , porte-coton	155
<b>HEGAR-MAYO-DELICATE</b> , porte-aiguilles tungstène <b>TUC</b>	108	<b>JOHNS-HOPKINS</b> , clamps bulldog	19
<b>HEGAR-OLSEN</b> , porte-aiguilles	106	<b>JOHNS-HOPKINS</b> , pinces à poser	19
<b>HEGAR-OLSEN</b> , porte-aiguilles tungstène <b>TUC</b>	113	<b>JONES</b> , pinces à champs	30
<b>HEGENBARTH</b> , pinces pour agrafes	126	<b>JOSEPH</b> , bistouris pour opérations du nez	334
<b>HEISTER</b> , ouvre-bouches	230	<b>JOSEPH</b> , ciseaux à dissection	71
<b>HENKE</b> , dissecteurs	248	<b>JOSEPH</b> , crochets très fins	139, 344
<b>HENKE-SASS/WOLF</b> , connexion	412	<b>JOSEPH</b> , élévateurs	337
<b>HENLEY</b> , écarteurs autostatiques	150	<b>JOSEPH</b> , instruments pour la plastique nasale	339, 356
<b>HERBERHOLD</b> , ouvre-bouches	235	<b>JOSEPH</b> , râpes nasales	340
<b>HESSBERG</b> , aiguilles à ligatures	125	<b>JOSEPH-MASING</b> , élévateurs	337
<b>HEYMANN</b> , ciseaux nasaux	73		
<b>HEYMANN</b> , pince ethmoïdales et pour la cloison nasale	330		
<b>HEYMANN-KNIGHT</b> , pinces à polypes nasaux	315		



	Page		Page
<b>K</b>			
<b>KABIERSKE</b> , lance-poudre	305	<b>LANGENBECK-MINI</b> , écarteurs fins	140
<b>KALT</b> , micro-porte-aiguilles tungstène <b>TUC</b>	117	<b>LANGENBECK-RYDER</b> , porte-aiguilles tungstène <b>TUC</b>	116
<b>KAYE</b> , ciseaux pour Face-lift	93	<b>LANGE-WILDE</b> , serre-noeuds pour polypes	282, 314
<b>KAZANJIAN</b> , pinces pour le nez	331	<b>LARKIN</b> , instruments pour chirurgie de l'étrier	296
<b>KELLY(RICHARDSON)</b> , écarteurs	145	Laryngoscopes	163-166
<b>KELLY</b> , pinces hémostatiques	24	Laryngoscopes à lumière froide	167-170, 178
<b>KELLY-RANKIN</b> , pinces hémostatiques	24	Laryngoscopes opératoires	172-180
<b>KELMAN-McPHERSON</b> , pinces pour sutures	53	<b>LEMPERT</b> , curettes	298
<b>KERRISON</b> , pinces pour sinus sphénoïdal	332	<b>LEMPERT</b> , élévateurs	298
<b>KILLIAN</b> , ciseaux pour le cloison	272	<b>LEMPERT</b> , pinces-gouges	224
<b>KILLIAN</b> , élévateurs	338	<b>LEMPERT</b> , rugines	298
<b>KILLIAN</b> , gouges	348	<b>LERICHE</b> , pinces hémostatiques	23
<b>KILLIAN</b> , pinces à polypes nasaux	315	<b>LEWIS</b> , râpes nasales	340, 343
<b>KILLIAN</b> , spéculums nasaux	312	<b>LEXER</b> , ciseaux à dissection	70
<b>KILLIAN-CLAUS</b> , gouges	348	<b>LEXER</b> , ciseaux tungstène <b>TUC</b>	90
<b>KILLIAN-EICKEN</b> , canules d'aspiration	159	<b>LEXER</b> , ciseaux-burins	202, 203
<b>KILNER(RAGNELL)</b> , ciseaux à dissection	71	<b>LEXER</b> , ostéotomes	202, 203
<b>KILNER</b> , crochets très fins	135, 345	<b>LEXER-BABY</b> , ciseaux à dissection	71
<b>KILNER</b> , porte-aiguilles	103	<b>LEXER-MINI</b> , ciseaux-burins	202
<b>KILNER</b> , porte-aiguilles tungstène <b>TUC</b>	110	<b>LEXER-MINI</b> , ostéotomes	202
<b>KILNER-DOUGHTY</b> , ouvre-bouches	232	<b>LICHTENBERG</b> , porte-aiguilles tungstène <b>TUC</b>	115
<b>KLEINERT-KUTZ</b> , crochets très fins	135	<b>LICHTWITZ</b> , trocars	156
<b>KLEINERT-KUTZ</b> , pinces-gouges	225	<b>LISTER</b> , ciseaux tungstène <b>TUC</b>	93
<b>KLINIKUM BERLIN</b> , presses-tube	32	<b>LISTER</b> , pinces à tampons	130
<b>KNAPP</b> , crochets très fins	139	<b>LISTON</b> , pinces coupantes à os	226
<b>KNIGHT</b> , pince ethmoïdales et pour la cloison nasale	330	<b>LISTON-RUSKIN</b> , pinces coupantes à os	227
<b>KNIGHT-HEYMANN</b> , pinces à polypes nasaux	315	<b>LISTON-WALTON</b> , pinces coupantes à os	227
<b>KOCHER</b> , écarteurs	142, 144	<b>LITTAUER</b> , ciseaux à ligatures	77
<b>KOCHER</b> , sondes	246	<b>LITTAUER</b> , pinces à épiler les cils	51
<b>KOCHER-DELICATE</b> , pinces hémostatiques	27	<b>LITTAUER-LISTON</b> , pinces coupantes à os	226
<b>KOCHER-LANGENBECK</b> , écarteurs	143	<b>LITTLE</b> , écarteurs	144
<b>KOCHER-OCHSNER</b> , pinces hémostatiques	26	<b>LITTLER</b> , ciseaux fins	75
<b>KOFFLER-HAJEK</b> , pinces pour sinus sphénoïdal	332	<b>LOCKHART-MUMMERY</b> , sondes	154
<b>KRAUSE</b> , pinces interchangeables	257	<b>LOPEZ-REINKE</b> , dissecteurs	249
<b>KRAUSE</b> , serre-noeuds pour polypes	282, 314	<b>LORNA</b> , pinces à champs	31
<b>KRAUSE-VOSS</b> , serre-noeuds pour polypes	282, 314	<b>LOVELACE-DIXON</b> , pinces hémostatiques	28
<b>KRESSNER</b> , instruments pour la plastique nasale	355	<b>LUBET-BARBON</b> , pinces à polypes nasaux	315
<b>KROENIG</b> , abaisse-langues	239	<b>LUC</b> , pince ethmoïdales et pour la cloison nasale	330
<b>KROENLEIN</b> , pinces à saisir	20	<b>LUCAE</b> , aiguilles à paracentèse	291
<b>KRONECKER</b> , aiguilles à ligatures	125	<b>LUCAE</b> , crochets auriculaires	290
<b>KRONE-MARSCHIK</b> , pinces pour amygdales	252	<b>LUCAE</b> , diapasons	303
<b>KUHN-BOLGER</b> , curettes tranchantes	347	<b>LUCAE</b> , marteaux	208
<b>KUTZ-KLEINERT</b> , crochets très fins	135	<b>LUCAE</b> , pinces nasales	52
<b>KUTZ-KLEINERT</b> , pinces-gouges	225	<b>LUCAS</b> , ciseaux-burins	197
<b>L</b>			
<b>LA FORCE</b> , adénotomes	354	<b>LUER</b> , canules pour trachéotomie	244
<b>LABORDE</b> , dilateurs	241	<b>LUER</b> , écarteurs pour trachéotomie	243
<b>LACK</b> , abaisse-langues	238	<b>LUER</b> , pinces-gouges	223
<b>LAHEY</b> , écarteurs	144	<b>LUKENS</b> , écarteurs pour trachéotomie	242
<b>LAHEY</b> , pinces à goître	246	Lunettes Nystagmus	186, 187
<b>LAMBOTTE</b> , ostéotomes	206	<b>LUNIATSCHECK</b> , dissecteurs	249
<b>LAMBOTTE-MINI</b> , ostéotomes	206	<b>M</b>	
Lames de rasoir	100	<b>MACKAY</b> , couteau falciforme	347
Lance-poudre	305	<b>MACKAY</b> , curettes tranchantes	347
<b>LANE</b> , pinces à champs	30	<b>MAGILL</b> , pinces pour sondes	171
<b>LANE</b> , pinces à griffes	38	<b>MAIER-GROSS</b> , pinces à pansements	131, 132
<b>LANGE</b> , crochets très fins	344	<b>MALTZ</b> , râpes nasale	340
<b>LANGE</b> , pinces à polypes laryngiens	273	Manches porte-électrodes	404
<b>LANGE</b> , pinces interchangeables	257	Manches porte-électrodes avec câble	405
<b>LANGE</b> , pinces pour agrafes	127	Manches pour bistouris	96-98
<b>LANGENBECK</b> , curettes auriculaires	289	Manches pour miroirs à bouche	268
<b>LANGENBECK</b> , doigtiers	230	Manches universels et pinces interchangeables	256, 257
<b>LANGENBECK</b> , élévateurs	216	Manœuvres, easyClean	394, 395
<b>LANGENBECK</b> , porte-aiguilles	107	<b>MARLIN</b> , matériel de suture	250
<b>LANGENBECK</b> , porte-aiguilles tungstène <b>TUC</b>	116	<b>MARQUARDT</b> , pinces-gouges	224
<b>LANGENBECK</b> , rugines-raspatoires	215	Marqueur pour facelift	188
<b>LANGENBECK-DELICATE</b> , porte-aiguilles tungstène <b>TUC</b>	116	<b>MARSCHIK</b> , pince pour amygdales	250
<b>LANGENBECK-KOCHER</b> , écarteurs	143	<b>MARSCHIK-KRONE</b> , pinces pour amygdales	252
		Marteaux	207-209, 302, 357
		<b>MARTEL</b> , pinces pour le cuir chevelu	20
		<b>MARTIN</b> , spéculums nasaux	312

<b>MARTIN/BERCHTOLD</b> , câbles de raccordement	406	<b>MIDDELDORPF</b> , écarteurs	145
<b>MARTIN/BERCHTOLD</b> , manches porte-électrodes	404	<b>MIDDLETON-JANSEN</b> , pinces coupantes pour le nez	329
<b>MARTIN/BERCHTOLD</b> , manches porte-électrodes avec câble	405	<b>MILLARD(COTTLE)</b> , crochets très fins	345
<b>MARTINI</b> , curettes tranchantes	214	<b>MILLER</b> , fibre optic laryngoscopes	169
<b>MARYLAND</b> , dissection émoussée	397	<b>MILLER</b> , laryngoscopes	165
<b>MASING</b> , bistouris pour opérations du nez	334	<b>MILLER-COLBURN</b> , râpes nasale	342
<b>MASING</b> , ciseaux-burins	352	<b>MILLER-SENN</b> , crochets très fins	141
<b>MASING</b> , crochets très fins	345	<b>MILLER-SENN</b> , écarteurs fins	141
<b>MASING</b> , élévateurs	338	<b>MILLER-SENN-BABY</b> , écarteurs fins	141
<b>MASING</b> , râpes nasale	341	<b>MILLIGAN</b> , écarteurs autostatiques	151
<b>MASING-JOSEPH</b> , élévateurs	337	<b>MINI</b> , manches de bistouris	98
<b>MASS.-GENERAL-HOSPITAL</b> , porte-aiguilles	105	<b>MINI-FRIEDMAN</b> , pinces-gouges	222
<b>MASTIN</b> , pince musculaire	246	<b>MINI-LAMBOTTE</b> , ostéotomes	206
<b>MATHIEU</b> , porte-aiguilles	106	<b>MINI-LANGENBECK</b> , écarteurs fins	140
<b>MATHIEU</b> , porte-aiguilles tungstène <b>TUC</b>	113	<b>MINI-LEXER</b> , ciseaux-burins	202
<b>MATHIEU-DELICATE</b> , porte-aiguilles	106	<b>MINI-LEXER</b> , ostéotomes	202
<b>MATHIEU-DELICATE</b> , porte-aiguilles tungstène <b>TUC</b>	114	<b>MINI-RUSKIN</b> , pinces-gouges	225
<b>MATHIEU-RYDER VASCULAR</b> , porte-aiguilles tungstène <b>TUC</b>	114	Miroirs à bouche	269, 270
<b>MATHIEU-RYDER</b> , porte-aiguilles tungstène <b>TUC</b>	114	Miroirs dentaire	269, 270
<b>MAUNDER</b> , baillons	230	Miroirs frontaux	181, 183
<b>MAYER-DAVIS</b> , ouvre-bouches	235	Miroirs laryngiens	271
<b>MAYFIELD</b> , pinces-gouges	224	Miroirs, laryngiens	271
<b>MAYO</b> , abaisse-langues	239	Miroirs, postrhinoscopique	272
<b>MAYO</b> , ciseaux	65	<b>MIXTER</b> , ciseaux à chirurgie	64
<b>MAYO</b> , ciseaux tungstène <b>TUC</b>	87	<b>MIXTER-BABY</b> , pinces à dissection et à ligatures	29
<b>MAYO</b> , clips de stérilisation	364	<b>MIXTER-O'SHAUGNESSY</b> , pinces à dissection et à ligatures	29
<b>MAYO-HEGAR</b> , porte-aiguilles	105	<b>MOD.BONN</b> , ciseaux fins	76
<b>MAYO-HEGAR</b> , porte-aiguilles tungstène <b>TUC</b>	108	<b>MOD.BONN</b> , pinces pour sutures	54
<b>MAYO-HEGAR-DELICATE</b> , porte-aiguilles	105	<b>MOD.WIEN</b> , spéculums nasaux	312
<b>MAYO-HEGAR-DELICATE</b> , porte-aiguilles tungstène <b>TUC</b>	108	<b>MOD.WÜRZBURG</b> , ouvre-bouches	234
<b>MAYO-STILLE</b> , ciseaux	65	<b>MODELL TÜBINGEN</b> , écarteurs autostatiques	152
<b>MAYO-STILLE</b> , ciseaux tungstène <b>TUC</b>	88	<b>MODELL TÜBINGEN</b> , pinces pour sutures	54
<b>MC INDOE</b> , instruments pour la plastique nasale	346	<b>MODELL USA</b> , pinces à dissection et à griffes	36
<b>MC INDOE</b> , pinces à dissection	37	<b>MOLDESTAD</b> , crochets très fins	137
<b>MC INDOE</b> , pinces coupantes à os	227	<b>MOLLISON</b> , dissecteurs	249
<b>MC INTOSH</b> , fibre optic laryngoscopes	167	<b>MOLLISON</b> , écarteurs autostatiques	151
<b>MC INTOSH</b> , laryngoscopes	163	<b>MOLT</b> , ouvre-bouches	230
<b>MC IVOR</b> , ouvre-bouches	234	<b>MORITZ-SCHMIDT</b> , abaisse-langues	238
<b>MCDONALD</b> , élévateurs	217	<b>MOSHER-WAGENER</b> , tube	243
<b>MCGEE</b> , crochets auriculaires	293	<b>MOSQUITO-HALSTED</b> , pinces hémostatiques	22
<b>MCGEE</b> , micro pinces auriculaires	286	<b>MOSQUITO-MICRO</b> , pinces hémostatiques	22
<b>MCKENTY</b> , élévateurs	337	<b>MUCK</b> , coutreaux	299
<b>MCKERNAN</b> , pinces à préhension	399	<b>MULDOON</b> , dilateurs pour le ductus salivarius	275
<b>MCKESSON</b> , baillons	237	<b>MUMMERY-LOCKHART</b> , sondes	154
<b>MCPHERSON</b> , pinces pour sutures	53	<b>MURRAY-CRILE</b> , porte-aiguilles	104
<b>MEAD</b> , marteaux	208	<b>MUSEUX</b> , pinces pour amygdales	252
<b>MEAD</b> , pinces-gouges	223	<b>MYLES</b> , canules à irrigation	335
Mesures graduées	360	<b>MYRTLE LEAF</b> , sondes	153
<b>METZENBAUM</b> , ciseaux à dissection	65, 66		
<b>METZENBAUM</b> , ciseaux endoscopiques	396, 400	<b>N</b>	
<b>METZENBAUM</b> , ciseaux tungstène <b>TUC</b>	88, 89	<b>NAGER</b> , releveurs du voile du palais pour amygdalotomie	251
<b>METZENBAUM</b> , porte-aiguilles tungstène <b>TUC</b>	114	<b>NASOPHARYNGOSCOPE FLEXIBLE</b>	403
<b>METZENBAUM-BABY</b> , ciseaux à dissection	66	<b>NEGUS(BECKMANN)</b> , couteaux à végétations adénoïdes	353
<b>METZENBAUM-DELICATE</b> , ciseaux à dissection	68	<b>NEGUS</b> , élévateur aspirant	335
<b>METZENBAUM-DELICATE</b> , ciseaux tungstène <b>TUC</b>	90, 91	<b>NEGUS</b> , support contre-poitrine pour ouvre-bouches	236
<b>METZENBAUM-NELSON</b> , ciseaux à dissection	67	<b>NEIVERT</b> , ostéotomes	352
<b>MEYERDING</b> , écarteurs fins	140	<b>NEIVERT</b> , porte-aiguilles	103
<b>MICHEL</b> , agrafes	127	<b>NEIVERT</b> , porte-aiguilles tungstène <b>TUC</b>	110
<b>MICHEL</b> , miroirs laryngiens	271	<b>NEIVERT-ANDERSON</b> , ostéotomes	352
<b>MICHEL</b> , pinces pour agrafes	126	<b>NEIVERT-COTTLE</b> , crochets très fins	345
Micro instruments	295	<b>NELATON</b> , sondes	153
Micro pinces auriculaires	285-288	<b>NELSON-METZENBAUM</b> , ciseaux à dissection	67
<b>MICRO-ADSON</b> , pinces à dissection et à griffes	36	<b>NEW ORLEANS</b> , porte-aiguilles tungstène <b>TUC</b>	109
Micro-ciseaux	79-84	<b>NEWS</b> , écarteurs pour trachéotomie	243
<b>MICRO-MOSQUITO</b> , pinces hémostatiques	22	<b>NIJMEGEN</b> , canules d'aspiration	159
Micro-pinces	46, 47	<b>NOLST-TRENITÉ JOSEPH</b> , instruments pour la plastique nasale	339
Micro-porte-aiguilles	117-123	<b>NOLST-TRENITÉ</b> , ostéotomes	350
Micro-porte-aiguilles à manches rondes	118-121	<b>NORTHBENT</b> , ciseaux à ligatures	78
Micro-porte-aiguilles tungstène <b>TUC</b>	74	<b>NOYES-HARTMANN</b> , pinces auriculaires	284
<b>MICRO-RYDER</b> , porte-aiguilles tungstène <b>TUC</b>	108		
<b>MICROVASCULAR</b> , porte-aiguilles tungstène <b>TUC</b>	109		
<b>MICRO-WULLSTEIN</b> , canules d'aspiration	159		

	Page		Page
<b>O</b>			
<b>O'BRIAN</b> , ciseaux fins	76	Pincés hémostatiques fines	22
<b>O'CONNOR</b> , crochets très fins	136	Pincés hémostatiques graciles	27
<b>OBWEGESER</b> , écarteurs	143	Pincés micro	46, 47
<b>OBWEGESER</b> , ostéotomes	352	Pincés nasales	52
<b>OCHSNER-KOCHER</b> , pincés hémostatiques	26	Pincés ostéotomes	288, 320, 321, 332, 333
<b>OEHLER</b> , pincés à dissection tungstène <b>TUC</b>	56	Pincés pour agrafes	126
<b>OLSEN-HEGAR</b> , porte-aiguilles	106	Pincés pour amygdales	250, 252
<b>OLSEN-HEGAR</b> , porte-aiguilles tungstène <b>TUC</b>	113	Pincés pour la cloison nasale	355
<b>OLYMPUS</b> , connexion	412	Pincés pour laryngo-bronchoscopie	267
Orthopédie	195-228	Pincés pour laryngologie	230
Ostéotomes	348-352	Pincés pour le cuir chevelu	28
Oto-/ophthalmoscopes	193	Pincés pour saisir l'intestin	17
Otoscope, vidéo	194	Pincés pour sinus frontal	317
<b>OTOSKOP UNI</b> , trousse à diagnostic	193	Pincés pour sinus sphénoïdal	332, 333
Ouvre-bouches	230-236	Pincés pour sondes	171
<b>P</b>			
<b>PARKER</b> , écarteurs	147	Pincés pour suture	53, 54, 126, 127
<b>PARTSCH</b> , ciseaux-burins	198	Pincés-gouges	222-225
<b>PARTSCH</b> , marteaux	208	Pincettes pour casser les lames	100
<b>PASSOW</b> , coutreaux	299	<b>PITHA</b> , baillons	230
<b>PAUFIQUE</b> , pincés pour sutures	54	Plateaux pour instruments	362
<b>PAULSEN</b> , canules à irrigation	335	<b>PLESTER</b> , canules d'aspiration	159
<b>PEAN</b> , pincés à saisir	20	<b>PLESTER</b> , couteaux	294
<b>PEAN-DELICATE</b> , pincés hémostatiques	27	<b>PLESTER</b> , écarteurs autostatiques	152
<b>PEAN-ROCHESTER</b> , pincés hémostatiques	25	<b>PLESTER</b> , micro instruments	295
<b>PEERS</b> , pincés à champs	31	<b>POLITZER</b> , aiguilles à paracentèse	291
<b>PEET</b> , pincés à échardes	50	<b>POLITZER</b> , bistouris	291
Peigne en métal	364	<b>POLITZER</b> , insufflateurs	305
<b>PENNINGTON</b> , instruments pour la plastique nasale	339	<b>POLITZER</b> , spéculums auriculaires	278
<b>PENNINGTON</b> , pincés à saisir	20	Ponction	156-162
<b>PERWITZSCHKY</b> , ciseaux fins	74, 275	<b>POOLE</b> , canules d'aspiration	158
<b>PETERSEN-SMITH</b> , ciseaux-burins	199	<b>POOLE-BABY</b> , canules d'aspiration	158
<b>PETERSEN-SMITH</b> , ostéotomes	199	Porte-aiguilles	102-116
<b>PIERCE</b> , instruments pour la plastique nasale	339	Porte-aiguilles tungstène <b>TUC</b>	108-119
<b>PIFFARD</b> , curettes tranchantes	212	Porte-aiguilles, endoscopie	397
<b>PILCHER</b> , spéculums nasaux	312	Porte-coton	154, 155
Pince à goitre	246	Porte-ligatures pour amygdales	226
Pince à sinus	318-327	<b>POTTS-SMITH</b> , pincés à dissection et à griffes	40
Pince compressive	307	<b>POTTS-SMITH</b> , pincés à dissection tungstène <b>TUC</b>	56
Pince ethmoïdales et pour la cloison nasale	330	<b>PRATT</b> , curettes tranchantes	347
Pince musculaire	246	<b>PRATT</b> , sonde fistulaire	154
Pince pour la Bi-Coagulation	410	<b>PRECISA</b> , tensiomètre à mercure	191
Pince pour la cloison nasale et ethmoïdales	330	<b>PRESBYTERIAN</b> , presses-tube	32
Pincés à biopsie pour endoscopie	396	Presses-tube	32
Pincés à champs	30, 31	<b>PRINCE</b> , ciseaux pour les amygdales	72
Pincés à compresses	31	<b>PROVIDENCE-HOSPITAL</b> , pincés hémostatiques	23
Pincés à dissection	34-42	<b>PYE-SMITH (HARRISON)</b> , pincés à stérilisation	364
Pincés à dissection tungstène <b>TUC</b>	56-58	<b>PYNCHON-ANDREWS</b> , canules d'aspiration	157
Pincés à échardes	48-50	<b>Q</b>	
Pincés à éponges	130-134	<b>QUIRE</b> , pincés auriculaires	283
Pincés à fixer	53	<b>R</b>	
Pincés à griffes	34-42	Raccords	162
Pincés à ligatures avec plate-forme	47	<b>RAGNELL(KILNER)</b> , ciseaux à dissection	71
Pincés à polypes	282, 314	<b>RAGNELL-DAVIS</b> , écarteurs fins	141
Pincés à polypes laryngiens	273	<b>RALK</b> , pincés à échardes	50
Pincés à polypes nasaux	315	<b>RAMPLEY</b> , pincés à éponges	134
Pincés à préhension	397-400	<b>RANKIN-CRILE</b> , pincés hémostatiques	24
Pincés à saisir	20	<b>RANKIN-KELLY</b> , pincés hémostatiques	24
Pincés à stérilisation	364	Râpes nasale	340-343
Pincés à torsader le fil tungstène <b>TUC</b>	116	Réceptifs cylindriques	363
Pincés atrauma	55	<b>REICHERT</b> , instruments pour laryngologie	272
Pincés auriculaires	52, 283, 284	<b>REILL</b> , micro-porte-aiguilles	120
Pincés coupantes à os	226, 227	<b>REINKE-LOPEZ</b> , dissecteurs	249
Pincés coupantes pour le nez	327-329	Releveur du voile du palais pour amygdalotomie	226
Pincés d'horloger	45	<b>REVERDIN</b> , aiguilles	124
Pincés de reposition	228	<b>REYNOLDS</b> , ciseaux à dissection	72
Pincés emporte-pièces pour amygdales	250, 252	<b>RICHARDSON(KELLY)</b> , écarteurs	145
Pincés hémostatiques	15-32	<b>RICHTER</b> , ciseaux à chirurgie	64
		<b>RICHTER-HEATH</b> , pincés pour agrafes	126

	Page		Page
<b>RING</b> , ouvre-bouches	234	<b>SHAMBAUGH-DERLACKI</b> , rugines	298
<b>RIRAP</b> , stéthoscopes	189	<b>SHAPLEIGH</b> , curettes auriculaires	289
<b>RITTER-HALLE</b> , dilataateurs pour le sinus frontal	335	<b>SHEA</b> , instruments pour chirurgie de l'étrier	296
Robinets	162	<b>SHEEHAN</b> , ostéotomes	351
<b>ROCHESTER-PEAN</b> , pinces hémostatiques	25	<b>SHORTBENT</b> , ciseaux à ligatures	78
<b>RÖDER</b> , porte-ligatures pour amygdales	250	<b>SIEGLE</b> , spéculums auriculaires	281
<b>ROEDER</b> , pinces à champs	31	<b>SILVER</b> , dermatomes	100
<b>ROGER</b> , élévateur pour cloison	336	<b>SILVER</b> , ostéotomes	352
<b>ROGGE</b> , pinces à stérilisation	364	<b>SIMPLEX</b> , écarteurs des joues	238
<b>ROLLET</b> , crochets très fins	139	<b>SINUSCOPY</b> , trocart	156
<b>ROSE</b> , écarteurs pour trachéotomie	243	<b>SLUDER-BALLENGER</b> , amygdalotome	253
<b>ROSEN</b> , aiguilles auriculaires	292, 293	<b>SMITH-FERRIS</b> , pinces à griffes	42
<b>ROSEN</b> , couteaux	294	<b>SMITH-FERRIS</b> , pinces pour sinus sphénoïdal	333
<b>ROSEN</b> , micro instruments	295	<b>SMITH-PETERSEN</b> , ciseaux-burins	199
<b>ROSER-KÖNIG</b> , ouvre-bouches	231	<b>SMITH-PETERSEN</b> , ostéotomes	199
<b>ROUX</b> , écarteurs	146	<b>SMITH-POTTS</b> , pinces à dissection et à griffes	40
<b>ROWE</b> , pinces de reposition	228	<b>SNELLEN</b> , anses auriculaires	290
<b>RUBIN</b> , instruments pour la plastique nasale	355	<b>SNITMAN</b> , écarteurs autostatiques	149
<b>RUBIN</b> , ostéotomes	351	Sondes	153-155, 274
Rugines-Raspatoires	215, 216, 298	Sondes exploratrices pour le ductus salivarius	274
<b>RUSKIN</b> , pinces-gouges	225	<b>SONNENSCHNEIN</b> , spéculums nasaux	312
<b>RUSKIN-LISTON</b> , pinces coupantes à os	227	Spéculum nasopharyngien	312
<b>RUSKIN-MINI</b> , pinces-gouges	225	Spéculums auriculaires	278-281
<b>RUSS.MODELL</b> , pinces pour saisir les tissus	44	Spéculums nasaux	311-313
<b>RYDER MICRO</b> , porte-aiguilles tungstène <b>TUC</b>	108	<b>SPENCER</b> , ciseaux à ligatures	77
<b>RYDER/FRENCH EYE</b> , porte-aiguilles tungstène <b>TUC</b>	108	<b>SPENCER-DELICATE</b> , ciseaux à ligatures	77
<b>RYDER-LANGENBECK</b> , porte-aiguilles tungstène <b>TUC</b>	116	<b>SPENCER-WELLS</b> , pinces hémostatiques	21
<b>RYDER-MATHIEU VASCULAR</b> , porte-aiguilles tungstène <b>TUC</b>	114	<b>SPRATT</b> , curettes tranchantes	211
<b>RYDER-MATHIEU</b> , porte-aiguilles tungstène <b>TUC</b>	114	<b>ST.BARTHOLOMEW</b> , pinces pour le nez	331
		<b>ST.CLAIR-THOMPSON</b> , couteaux à végétations adénoïdes	354
<b>S</b>		<b>ST.CLAIR-THOMPSON</b> , miroirs postrhinoscopique	272
<b>SANVENERO</b> , ciseaux à dissection	71	<b>ST.MARTIN</b> , pinces pour sutures	53
<b>SAROT</b> , porte-aiguilles	104	<b>STACKE</b> , sondes	153
<b>SAROT</b> , porte-aiguilles tungstène <b>TUC</b>	111	<b>STAMMBERGER</b> , pince à sinus	324
<b>SAUERBRUCH</b> , écarteurs	144	<b>STANDARD CLAR</b> , éclairateurs frontaux	182
<b>SCALP-CONTOUR</b> , écarteurs autostatiques	152	<b>STANDARD</b> , abaisse-langues	239
<b>SCHAEDEL</b> , pinces à champs	30	<b>STANDARD</b> , ciseaux à chirurgie	62
<b>SCHÄFER</b> , écarteurs	358	<b>STANDARD</b> , ciseaux tungstène <b>TUC</b>	86, 87
<b>SCHUDE</b> , curettes tranchantes	211	<b>STANDARD</b> , pinces à dissection et à griffes	34
<b>SCHEINMANN</b> , pinces interchangeableables	257	<b>STELLBRINK</b> , pinces-gouges	222
<b>SCHINK</b> , dermatome	99	<b>STERNBERG</b> , écarteurs des joues et des lèvres	238
<b>SCHMEDEN</b> , pinces coupantes pour le nez	328	<b>STERNUM</b> , pinces à torsader le fil tungstène <b>TUC</b>	116
<b>SCHMEDEN</b> , pinces emporte-pièces pour amygdales	255	Stéthoscopes	189, 190
<b>SCHMIDT-MORITZ</b> , abaisse-langues	238	<b>STEVENS</b> , ciseaux à ténotomie	77
<b>SCHOEMAKER</b> , ciseaux à goitre	73	<b>STEVENS</b> , ciseaux tungstène <b>TUC</b>	92
<b>SCHOENBORN</b> , écarteurs pour trachéotomie	242	<b>STIEGLITZ</b> , pinces à échardes	50
<b>SCHUKNECHT(BARON)</b> , canules d'aspiration	300	<b>STIERLEN</b> , abaisse-langues	241
<b>SCHUKNECHT</b> , couteaux	294	<b>STILLE</b> , ciseaux-burins	201
<b>SCHUHNECHT</b> , écarteurs autostatiques	151	<b>STILLE</b> , ostéotomes	201
<b>SCHUHNECHT</b> , instr. p. modeler les prothèses stapédiennes en fil	297	<b>STILLE</b> , pinces à dissection et à griffes	42
<b>SCHUMACHER</b> , pinces interchangeableables	257	<b>STILLE-MAYO</b> , ciseaux	65
<b>SCHWECKENDICK-GOOD</b> , ciseaux pour les amygdales	72	<b>STILLE-MAYO</b> , ciseaux tungstène <b>TUC</b>	88
<b>SEBILEAU</b> , élévateurs	216	<b>STORZ</b> , connexion	412
<b>SECCO</b> , manches pour miroirs à bouche	268	<b>STRÜMPFEL</b> , pinces auriculaires	284
<b>SEIFFERT</b> , pinces interchangeableables	257	<b>STRUYCKEN</b> , pince à sinus	319
<b>SELECT/ERBE</b> , câbles de raccordement	406	<b>STRUYCKEN</b> , pinces coupantes pour le nez	328, 329
<b>SEMKEN</b> , pinces à dissection et à griffes	37, 38	<b>STRYKER</b> , connexion	412
<b>SEMKEN</b> , pinces à dissection tungstène <b>TUC</b>	56	<b>SULLIVAN(BROPHY)</b> , ciseaux fins	75
<b>SENN-GREEN</b> , écarteurs fins	140	Super Cut ciseaux	61
<b>SENNING(SHWED.MODELL)</b> , porte-aiguilles	105	Support contre-poitrine pour ouvre-bouches	236
<b>SENNING(SHWED.MODELL)</b> , porte-aiguilles tungstène <b>TUC</b>	109	Suture	101-128
<b>SENN-MILLER</b> , écarteurs fins	141	<b>SYME</b> , aiguilles à ligatures	124
<b>SENN-MILLER-BABY</b> , écarteurs fins	141	Système de conteneur	365-388
<b>SEPTUM</b> , aiguilles pour septum	335		
Seringues	161, 306	<b>T</b>	
Seringues auriculaires	306	<b>TABB</b> , couteaux	294
Serre-noeuds pour l'ablation des amygdales	254	<b>TAKAHASHI</b> , pince à sinus	319
Serre-noeuds pour polypes	314	<b>TAKAHASHI</b> , pinces coupantes pour le nez	329
Serre-noeuds pour polypes	282, 314	<b>TAYLOR</b> , pinces à dissection et à griffes	38
<b>SEWALL</b> , curettes	347	<b>TAYLOR-CUSHING</b> , pinces à dissection tungstène <b>TUC</b>	57
<b>SHAMBAUGH</b> , crochets auriculaires	292	Tensiomètre à mercure	191



	Page		Page
<b>TERRIER</b> , pinces hémostatiques	21	<b>WEBSTER</b> , porte-aiguilles tungstène <b>TUC</b>	110
<b>THIESS</b> , marteaux	208	<b>WEERDA</b> , dilateurs	241
<b>THOMPSON-ST. CLAIR</b> , miroirs postrhinoscopique	272	<b>WEIL-BLAKESLEY</b> , pince à sinus	318, 319
<b>THOREK</b> , ciseaux à dissection	70	<b>WEIL-BLAKESLEY</b> , pinces coupantes pour le nez	327
<b>THUDICHUM(GOLDSMITH)</b> , spéculums nasaux	313	<b>WEINGÄRTNER</b> , pinces auriculaires	284
<b>TIECK-HALLE</b> , spéculums nasaux	311	<b>WEITLANER</b> , écarteurs autostatiques	150
<b>TILLEY</b> , pinces auriculaires	283	<b>WEITLANER-BABY</b> , écarteurs autostatiques	150
<b>TIVNEN</b> , pinces pour amygdales	252	<b>WELLS-SPENCER</b> , pinces hémostatiques	21
<b>TOBOLD</b> , abaisse-langues	238	<b>WEST</b> , ciseaux-burins	348
<b>TOENNIS</b> , porte-aiguilles	107	<b>WEST</b> , gouges	348
<b>TOENNIS</b> , porte-aiguilles tungstène <b>TUC</b>	115	<b>WESTMACOTT</b> , pinces à polypes nasaux	315
<b>TOENNIS-ADSON-DELICATE</b> , ciseaux tungstène <b>TUC</b>	93	<b>WHITE</b> , pinces pour amygdales	252
<b>TOHOKU-JAPAN</b> , pinces à champs	31	<b>WHITEHEAD</b> , ouvre-bouches	232
<b>TOYNBEE</b> , spéculums auriculaires	278	<b>WIEDER</b> , abaisse-langues	238
Trachéotomes	241	<b>WIENER</b> , râpes nasale	341
<b>TRELAT</b> , élévateur pour périoste	336	<b>WILDE(TROELTSCH)</b> , pinces auriculaires	52
<b>TREPSAT</b> , ciseaux à face-lift	69	<b>WILDE-LANGE</b> , serre-nœuds	282, 314
Trocards à manche et trocards	393	<b>WILDER</b> , dilateurs pour le ductus salivarius	275
Trocarts	156, 241	<b>WILLIAMS-WATSON</b> , pinces coupantes pour le nez	327
<b>TROELTSCH(WILDE)</b> , pinces auriculaires	52	<b>WILLIGER</b> , curettes tranchantes	214
<b>TROUSSEAU</b> , dilateurs	241	<b>WILLIGER</b> , élévateurs	216
Trousses à diagnostic	192, 193	<b>WILLIGER</b> , marteaux	207
<b>TROUTMAN-CHRIS</b> , pincettes pour casser les lames	100	<b>WILLIGER</b> , rugines-raspatoires	216
<b>TÜBINGER</b> , tubos de ventilation	307	<b>WILMER</b> , ciseaux à iridectomie	76
Tubos de ventilation	307	<b>WINTER + IBE</b> , connexion	412
<b>TUFFIER</b> , pinces à saisir	20	<b>WISCONSIN(FOREGGER)</b> , fibre Optic laryngoscopes	168
<b>TYDING</b> , pinces pour amygdales	252	<b>WISCONSIN(FOREGGER)</b> , laryngoscopes	164
<b>TYDING</b> , serre-nœuds pour l'ablation des amygdales	254	<b>WOLF/HENKE-SASS</b> , connexion	412
		<b>WULLSTEIN MICRO</b> , canules d'aspiration	159
<b>U</b>		<b>WULLSTEIN</b> , canules d'aspiration	300
<b>UCKERMANN</b> , porte-coton	155	<b>WULLSTEIN</b> , couteaux	294
<b>UCKERMANN</b> , trachéotomes	241	<b>WULLSTEIN</b> , écarteurs autostatiques	151
<b>UFFENORDE</b> , curettes tranchantes	348	<b>WULLSTEIN</b> , élévateurs	298
<b>UNI OTOSKOP</b> , trousses à diagnostic	193	<b>WULLSTEIN</b> , micro pinces auriculaires	288
<b>UNI-ECONOM</b> , trousses à diagnostic	192	<b>WULLSTEIN-HARTMANN</b> , pinces auriculaires	284
<b>UNIV.MINNESOTA</b> , abaisse-langues	239	<b>WÜRZBURG</b> , dissecteurs	249
<b>UNIVERSAL</b> , pinces-gouges	222		
		<b>Y</b>	
<b>V</b>		<b>YANKAUER</b> , canules d'aspiration	157
<b>VALLEYLAB</b> , câbles de raccordement	406	<b>YANKAUER</b> , spéculums nasaux	312
<b>VALLEYLAB</b> , manches porte-électrodes avec câble	405	<b>YANKAUER-WALTON</b> , canules d'aspiration	157
<b>VASCULAR RYDER-MATHIEU</b> , porte-aiguilles tungstène <b>TUC</b>	114	<b>YOUNG</b> , pinces tire-langue	240
<b>VERHOEVEN</b> , canules d'aspiration	301		
Video-Otoscope	194	<b>Z</b>	
<b>WISE</b> , pinces à ligatures avec plate-forme	46	<b>ZAUFAL</b> , crochets auriculaires	290
<b>VOLKMANN</b> , curettes tranchantes	210, 214	<b>ZAUFAL-JANSEN</b> , pinces-gouges	225
<b>VOLKMANN</b> , écarteurs	142	<b>ZIEGLER</b> , pinces à épiler les cils	51
<b>VOLTOLINI(DUPLAY)</b> , spéculums nasaux	313	<b>ZÖLLNER</b> , canules d'aspiration	300
<b>VOSS-KRAUSE</b> , serre-nœuds	282, 314	Zoom-Connexion	413
<b>W</b>			
<b>WACHENFELDT</b> , pinces pour agrafes	126		
<b>WAGENER</b> , crochets auriculaires	290		
<b>WAGENER-MOSHER</b> , tube	243		
<b>WAGNER</b> , ciseaux fins à chirurgie	74		
<b>WALSHAM</b> , pinces pour la cloison nasale	355		
<b>WALTER(AUFRICHT)</b> , instruments pour la plastique nasale	346		
<b>WALTER</b> , ciseaux-burins	351		
<b>WALTER</b> , écarteurs fins	141		
<b>WALTER</b> , ostéotomes	351		
<b>WALTON</b> , ciseaux fins	76		
<b>WALTON-LISTON</b> , pinces coupantes à os	227		
<b>WALTON-YANKAUER</b> , canules d'aspiration	157		
<b>WANGENSTEEN</b> , pinces à dissection tungstène <b>TUC</b>	58		
<b>WARTENBERG</b> , instruments sensibilités	188		
<b>WATSON</b> , dermatome	99		
<b>WATSON-WILLIAMS</b> , pinces coupantes pour le nez	327		
<b>WAUGH</b> , pinces pour saisir les tissus	43		
<b>WEBSTER</b> , porte-aiguilles	103		





# Indice alfabetico

	Pagina		Pagina
<b>A</b>		<b>BACON</b> , pinze-sgorbie	224
Abbassalingua	238, 239	<b>BAINBRIDGE</b> , pinze emostatiche	28
<b>ABRAHAM</b> , bisturi per tonsille	247	<b>BALL &amp; SOCKET</b> , pinze per fissare le compresse	31
Accessori per (laser) laringoscopi operatori	177, 179, 180	<b>BALLENGER</b> , bisturi per il setto nasale	336
<b>ACM/HEINE</b> , adattatore	412	<b>BALLENGER</b> , elevatore per setto	336
Adattatore	412	<b>BALLENGER</b> , pinze per tonsille	252
Adenotomi	354	<b>BALLENGER</b> , sgorbie	348
<b>ADLERKREUTZ</b> , pinze anatomiche e chirurgiche	42	<b>BALLENGER-FOERSTER</b> , pinze per spugne	133, 134
<b>ADSON</b> , canule per aspirazione	160	<b>BALLENGER-SLUDER</b> , tonsillotomo	253
<b>ADSON</b> , pinze anatomiche e chirurgiche	36, 37	<b>BARBARA</b> , aghi auricolari	292, 293
<b>ADSON</b> , pinze tungsteno <b>TUC</b>	57	<b>BARBON-LUBET</b> , pinze per polipi nasali	315
<b>ADSON</b> , portaghi	105	<b>BARNHILL</b> , coltelli per vegetazioni adenoidee	353
<b>ADSON-BABY</b> , divaricatori autostatici	152	<b>BARON(SCHUKNECHT)</b> , canule per aspirazione	300
<b>ADSON-BROWN</b> , pinze anatomiche e chirurgiche	37	<b>BARSKY</b> , strumenti per la plastica nasale	346
<b>ADSON-MICRO</b> , pinze anatomiche e chirurgiche	36	<b>BARTH</b> , cucchiaini auricolari	289
<b>ADSON-TOENNIS-DELICATE</b> , forbici tungsteno <b>TUC</b>	93	<b>BAUMGARTNER</b> , portaghi	105
<b>ADVENTITIA</b> , micro forbici	80, 82	<b>BEALES</b> , elevatori	299
<b>AF</b> -strumenti ed accessori	407-410	<b>BECKMANN(NEGUS)</b> , coltelli per vegetazioni adenoidee	353
Aghi auricolari	292, 293	<b>BECKMANN</b> , coltelli per vegetazioni adenoidee	353
Aghi di Réverdin	124	<b>BECKMANN</b> , specoli nasali	311
Aghi per legatura	124, 125	<b>BEER</b> , pinze depilatorie	51
Aghi per paracentesi	291	<b>BELLUCCI</b> , micro pinze auricolari	287
Aghi per Septum	335	<b>BERCHTOLD/MARTIN</b> , cavi da connessione	406
Aghi per tonsille	251	<b>BERCHTOLD/MARTIN</b> , mancini porta elettrodi	404
Aghi speciali	156-162	<b>BERCHTOLD/MARTIN</b> , mancini porta elettrodi con cavo	405
Ago per sutura tonsillare	226	<b>BERNHARD</b> , fissatele	30
Agrafes	127	<b>BEYER</b> , pinze osteotomi	288
<b>ALDERDYCE</b> , elevatori	217	<b>BEYER</b> , pinze-sgorbie	225
<b>ALEXANDER</b> , scalpelli	198	Bicchieri graduati	360
<b>ALLIGATOR</b> , pinze per polipi laringei	273	<b>BILLEAU</b> , anse auricolari	290
<b>ALLIS</b> , pinze da presa	398	Biopsia	396
<b>ALLIS</b> , pinze per afferrare tessuti	17	Bisturi per il setto nasale	334
<b>ALM</b> , divaricatori autostatici	149	Bisturi per operazioni nasali	334
<b>ALY</b> , strumenti per sensibilità	188	Bisturi per tonsille	247
<b>ANDERSON-NEIVERT</b> , osteotomi	352	<b>BLOHMKE</b> , pinze per tonsille	252
<b>ANDREWS-PYNCHON</b> , cannule per aspirazione	157	<b>BLUMENTHAL</b> , pinze-sgorbie	223
Anestesia	163-180	<b>BÖHLER</b> , pinze-sgorbie	225
Anse	290	<b>BOIES</b> , strumenti per la plastica nasale	356
Anse auricolari	290	<b>BOLGER-KUHN</b> , curette taglienti	347
Apribocca	230-236	<b>BONACCOLTO</b> , pinze per sutura	54
<b>ARRUGA</b> , portaghi	102	<b>BONNEY</b> , pinze per afferrare tessuti	44
<b>ARRUGA</b> , portaghi tungsteno <b>TUC</b>	115	<b>BONNEY</b> , pinze tungsteno <b>TUC</b>	58
Articoli diversi	381-388	<b>BOSE</b> , dilatatori	241
<b>ASCH</b> , pinze per raddrizzare il setto nasale	355	<b>BOSE</b> , uncini tracheali	242
Astucci per diagnostica	192, 193	<b>BÖTTCHER</b> , forbici per tonsille	72
<b>AUFRICTH GLABELLA</b> , raspe nasali	340	<b>BOUCHERON</b> , specoli auricolari	279
<b>AUFRICTH(WALTER)</b> , strumenti per la plastica nasale	346	<b>BOWMAN</b> , sonde esploratrici per ductus salivarius	274
<b>AUFRICTH</b> , elevatore periostale	336	<b>BOYLE-DAVIS</b> , apribocca	233
<b>AUFRICTH</b> , raspe nasali	340	<b>BOYNTON</b> , portaghi	102
<b>AUFRICTH</b> , strumenti per la plastica nasale	346	<b>BOYNTON</b> , portaghi tungsteno <b>TUC</b>	115
<b>AUSTIN</b> , pinze per legature	46	<b>BRODIE</b> , sonde	154
<b>B</b>		<b>BROPHY(SULLIVAN)</b> , forbici fine	75
<b>BABCOCK</b> , pinze da presa	399	<b>BROPHY</b> , pinze anatomiche e chirurgiche	40
<b>BABCOCK</b> , pinze per afferrare l'intestino	17	<b>BROWN</b> , pinze anatomiche e chirurgiche	41
<b>BABY-ADSON</b> , divaricatori autostatici	152	<b>BROWN-ADSON</b> , pinze anatomiche e chirurgiche	37
<b>BABY-CRILE-WOOD</b> , portaghi	104	<b>BRUENINGS</b> , abbassalingua	239
<b>BABY-CRILE-WOOD</b> , portaghi tungsteno <b>TUC</b>	111	<b>BRUENINGS</b> , bisturi per tonsille	247
<b>BABY-LEXER</b> , forbici per preparazioni	71	<b>BRUENINGS</b> , pinze etmoidali e per il setto nasale	330
<b>BABY-METZENBAUM</b> , forbici per preparazioni	66	<b>BRUENINGS</b> , pinze intercambiabili	256, 257
<b>BABY-MIXTER</b> , pinze per preparazioni e legature	29	<b>BRUENINGS</b> , serranodi per tonsille	254
<b>BABY-POOLE</b> , canule per aspirazione	158	<b>BRUENINGS</b> , specoli auricolari	280
<b>BABY-WEITLANER</b> , divaricatori autostatici	150	<b>BRUENINGS-BRUNK</b> , divaricatori	358
Bacinelle per strumenti	362	<b>BRUNS</b> , curette taglienti	210, 213
Bacinelle reniformi	360	<b>BRYANT</b> , pinze per spugne	130
<b>BACKHAUS</b> , fissatele	31	<b>BUCK</b> , curette auricolari	289
		<b>BUCK</b> , forbici per legatura	78
		<b>BUCK</b> , pinze auricolari	283
		<b>BUCKINGHAM</b> , strumenti per lo stapes	296



Bulldog, pinze 18, 19

## C

**CAIRNS**, pinze emostatiche 27  
**CANFIELD**, bisturi per tonsille 247  
 Cannula per tonsille 253  
 Cannule per irrigazione 335  
 Canule per aspirazione 157-160, 300, 301  
 Canule tracheali 244  
**CAPLAN**, forbici nasale 73  
**CARDIFF**, specoli nasali 312  
**CARDIOPHON**, stetoscopi 190  
**CARPENTER**, bisturi per tonsille 247  
**CARREL**, pinze emostatiche 21  
**CARROLL**, portaghi 104  
**CARROLL**, portaghi tungsteno **TUC** 109  
**CARTER**, elevatore per setto 336  
**CASTROVIEJO**, micro-portaghi tungsteno **TUC** 117  
**CASTROVIEJO**, pinze per rompere le lamette 100  
**CASTROVIEJO**, pinze per sutura 53  
 Cavi da connessione 406, 407  
 Cavo fibra ottica 411  
 Cesioie per ossa 226, 227  
**CHADWICK**, forbici oftalmologiche 77  
**CHAPUT**, pinze per afferrare 20  
**CHEATLE**, pinze per sterilizzazione 364  
**CHEVALIER-JACKSON**, canule tracheali 244  
**CHILDE**, pinze per agrafes 127  
**CHRIS-TROUTMAN**, pinze per rompere le lamette 100  
**CINELLI**, scalpelli 351  
**CITELLI**, pinze osteotomi 288  
**CLAR 55**, lampade frontali 182  
**CLAR STANDARD**, lampade frontali 182  
**CLAUS-HAJEK**, pinze per seno sfenoidale 333  
**CLAUS-KILLIAN**, sgorbie 348  
**CLEVELAND**, cesioie per ossa 227  
**CLEVELAND**, pinze-sgorbie 222  
**CLEVELAND-GARDNER**, cesioie per ossa 226  
**CLOWARD**, curette taglienti 213  
**COAKLEY**, curette 347  
**COBB**, scalpelli 204  
**COLBURN-MILLER**, raspe nasali 342  
**COLLER**, pinze emostatiche 24  
**COLLIER**, portaghi 102  
**COLLIN**, manici per bisturi 97  
**COLLIN**, martelli 207  
**COLLIN**, pinze per agrafes 126  
**COLLIN**, pinze tirlingua 240  
**COLLIN-DUVAL**, pinze per afferrare tessuti 43  
**COLLIN-HARTMANN**, divaricatori 146  
 Coltelli per vegetazioni adenoidee 353, 354  
 Coltello per setto 336  
**COLVER**, pinze per tonsille 252  
**CONE**, divaricatori autostatici 152  
 Contenitore 1/1 376-380  
 Contenitore 1/2 368-371  
 Contenitore 3/4 371-375  
 Contenitore, endoscopia 385-387  
**CONVERSE**, bisturi per operazioni nasali 334  
**CONVERSE**, divaricatori sottili 345  
**CONVERSE**, portaghi tungsteno **TUC** 110  
**CONVERSE**, scalpelli 352  
**CONVERSE**, strumenti per la plastica nasale 346  
**CONVERSE-DERF**, portaghi 102  
**CORDES**, pinze intercambiabili 257  
**CORWIN**, pinze per ritorcere **TUC** 116  
**COTTLE KAZANJIAN**, cesioie per ossa 226  
**COTTLE(MILLARD)**, divaricatori sottili 345  
**COTTLE**, bisturi per operazioni nasali 334  
**COTTLE**, divaricatori sottili 344, 345  
**COTTLE**, elevatori 338

**COTTLE**, forbici nasale 73  
**COTTLE**, martelli 207, 302, 357  
**COTTLE**, osteotomi 349  
**COTTLE**, pinza per columella 346  
**COTTLE**, pinze nasale 52  
**COTTLE**, raspe nasali 340, 343  
**COTTLE**, scalpelli 349  
**COTTLE**, specoli nasali 313  
**COTTLE**, strumenti per la plastica nasale 346  
**COTTLE**, trita cartilagine 356  
**COTTLE-NEIVERT**, divaricatori sottili 345  
**COUPLAND**, canule per aspirazione 158  
**CRAIG**, pinze etmoidali e per il setto nasale 330  
**CRILE**, pinze emostatiche 24  
**CRILE**, portaghi 107  
**CRILE-MURRAY**, portaghi 104  
**CRILE-RANKIN**, pinze emostatiche 24  
**CRILE-WOOD**, portaghi 104  
**CRILE-WOOD**, portaghi tungsteno **TUC** 111  
**CRILE-WOOD-BABY**, portaghi 104  
**CRILE-WOOD-BABY**, portaghi tungsteno **TUC** 111  
**CRURA-NIPPER**, micro pinze auricolari 286  
 Cucchiai 289, 347, 348  
 Cucchiai auricolari 289  
 Curette 210-214, 289, 298, 347, 348  
 Curette auricolari 289, 298, 299  
 Curette taglienti 210-214  
**CUSHING**, divaricatori sottili 137  
**CUSHING**, pinze anatomiche e chirurgiche 39  
**CUSHING**, pinze tungsteno **TUC** 57  
**CUSHING-TAYLOR**, pinze tungsteno **TUC** 57

## D

**DAHMEN**, osteotomi 205  
**DAHMEN**, scalpelli 205  
**DANDY**, pinze per il cuoio capelluto 28  
**DAVIS-BOYLE**, apribocca 233  
**DAVIS-MAYER**, apribocca 235  
**DAVIS-RAGNELL**, divaricatori sottili 141  
**DE BAKEY**, cannule per aspirazione 157  
**DE BAKEY**, pinze atrauma 55  
**DE BAKEY**, pinze da presa 398  
**DE BAKEY**, pinze tungsteno **TUC** 58  
**DE BAKEY**, portaghi tungsteno **TUC** 108  
**DE LA ROZA**, aghi per legatura 125  
**DEAVER**, forbici per chirurgia 64  
**DENHART**, apribocca 231  
**DERF**, portaghi 102  
**DERF**, portaghi tungsteno **TUC** 110  
**DERF-CONVERSE**, portaghi 102  
**DERLACKI-SHAMBAUGH**, periostotomi 298  
 Dermatomi 99, 100  
**DESMARRES**, divaricatori sottili 141  
 Diagnostica 181-194  
 Diapason 303, 304  
**DIEFFENBACH**, pinze bulldog 19  
**DIETER**, micro pinze auricolari 287  
**DIETHRICH**, micro-portaghi tungsteno **TUC** 117  
 Dilatore per vasi 47  
 Dilatori 241  
 Dilatori per ductus salivarius 275  
 Dilatori per il seno frontale 335  
 Dimensione diversa e accessori 359-364  
**DINGMANN**, apribocca 233  
**DISSECTION**, micro-forbici 80, 82  
 Dissettori 248-250, 307  
 Dissettori, Face-Lift 218-221  
 Dissezione smusse 397  
 Dissezione tagliente 396, 400  
 Ditali 230  
 Divaricatori 135-152, 240, 241, 358

	Pagina		Pagina
Divaricatori autostatici	149-152	Forbici micro	79-84
Divaricatori con illuminazione a luce fredda	148	Forbici nasale	73
Divaricatori ottico	148	Forbici per chirurgia	62-65
Divaricatori per guance e labbra	238, 239	Forbici per dissezione nervi	70
Divaricatori per uvula	226	Forbici per facelift	69
Divaricatori sottili	135-141, 344, 345	Forbici per gozzo	73
<b>DIXON-LOVELACE</b> , pinze emostatiche	28	Forbici per incisioni	64
<b>DOLPHIN</b> , dissezione smusse	397, 400	Forbici per iridectomia	76
<b>DOUGHTY-KILNER</b> , apribocca	232	Forbici per legatura	77, 78
<b>DOUGLAS</b> , bisturi per tonsille	247	Forbici per nervi	70
<b>DOUGLAS</b> , pinze depilatorie	51	Forbici per preparazioni	65-72
<b>DOYEN</b> , abbassalingua	239	Forbici per tonsille	72
<b>DOYEN</b> , fissatele	30	Forbici Super-Cut <b>SC</b>	61
<b>DOYEN</b> , portaghi	102	Forbici tungsteno <b>TUC</b>	85-93
<b>DOYEN</b> , sonde	153	Forbici, endoscopia	396
<b>DRAFFIN</b> , supporto di petto bipod	236	<b>FOREGGER(WISCONSIN)</b> , fibre optic laringoscopi	168
<b>DUCKBILL</b> , pinze auricolari	284	<b>FOREGGER(WISCONSIN)</b> , laringoscopi	164
<b>DUEHRSEN</b> , pinze anatomiche e chirurgiche	41	<b>FOX</b> , curette taglienti	212
<b>DUNHILL</b> , pinze emostatiche	27	<b>FOX-GOLDMAN</b> , forbici tungsteno <b>TUC</b>	93
<b>DUPLAY(VOLTOLINI)</b> , specoli nasali	313	<b>FRAENKEL</b> , pinze intercambiabili	257
<b>DUPLAY</b> , pinze per polipi	133	<b>FRAENKEL</b> , pinze per polipi laringei	272, 273
<b>DUPLEX</b> , stetoscopi	190	<b>FRAZIER</b> , canule per aspirazione	159
<b>DUPUY WEISS</b> , aghi per tonsille	251	<b>FRAZIER</b> , divaricatori sottili	135
<b>DURANTE</b> , pinze per afferrare tessuti	44	<b>FREEMAN-GORNEY</b> , forbici per face-lift	69
<b>DUVAL</b> , pinze per afferrare tessuti	44	<b>FREER</b> , bisturi per operazioni nasali	334
<b>E</b>		<b>FREER</b> , divaricatori sottile	344
easyClean	394-399	<b>FREER</b> , elevatore con aspirazione	335
<b>ECONOM</b> , astucci per diagnostica	192	<b>FREER</b> , elevatori	217, 337
<b>EICKEN-KILLIAN</b> , canule per aspirazione	159	<b>FREER</b> , scalpelli	348
Elettrodi	408, 409	<b>FREER</b> , sgorbie	348
Elevatore con aspirazione	335	<b>FREER</b> , strumenti per rinoplastica	334
Elevatori	216, 217, 298, 299	<b>FRENCH-EYE</b> , portaghi tungsteno <b>TUC</b>	108
Elevatori per il setto nasale	336-338	<b>FRENCH-HARTMANN</b> , diapason	303
Endoscopi	401, 402	<b>FRENZEL</b> , abbassalingua	239
Endoscopia	399-413	<b>FRIEDMAN</b> , pinze-sgorbie	222
<b>ENGL.MODELL</b> , fissatele	30	<b>FULLER</b> , micro pinze auricolari	287
<b>ERBE (U.S.)</b> , mancini porta elettrodi con cavo	405	<b>G</b>	
<b>ERBE</b> , cavi da connessione	406	<b>GALLAGHER</b> , raspe nasale	340
<b>ERBE</b> , mancini porta elettrodi	404	<b>GARDNER-CLEVELAND</b> , cesoie per ossa	226
<b>ERBE/SELECT</b> , cavi da connessione	406	<b>GELFOAM-HOUSE</b> , pinza a pressione	307
<b>EUFRATE-PASQUE</b> , portaghi tungsteno <b>TUC</b>	109	<b>GEMINI</b> , pinze per preparazioni e legatura	29
<b>EVES</b> , serranodi per tonsille	254	<b>GERALD</b> , pinze anatomiche e chirurgiche	39
<b>EWALD</b> , pinze anatomiche e chirurgiche	37	<b>GILLIES</b> , divaricatori sottili	135
<b>F</b>		<b>GILLIES</b> , pinze chirurgiche	43
Face-Lift dissettori	218-221	<b>GILLIES</b> , pinze tungsteno <b>TUC</b>	56
<b>FARABEUF</b> , divaricatori	147	<b>GILLIES</b> , portaghi	106
<b>FARRELL</b> , portacotone	154	<b>GILLIES</b> , portaghi tungsteno <b>TUC</b>	113
<b>FARRIOR</b> , specoli auricolari	279	<b>GLASSMANN</b> , pinze da presa	398
<b>FAULKNER</b> , curette	347	<b>GOLDMAN-FOX</b> , forbici tungsteno <b>TUC</b>	93
<b>FEILCHENFELD</b> , pinze per schegge	48	<b>GOLDMANN</b> , strumenti per la plastica nasale	356
<b>FEIN</b> , portacotone	155	<b>GOLDSMITH(THUDICHUM)</b> , specoli nasali	313
<b>FERGUSSON</b> , canule per aspirazione	159	<b>GOOD</b> , forbici per tonsille	72
<b>FERREIRA</b> , divaricatori	148	<b>GOOD-SCHWECKENDICK</b> , forbici per tonsille	72
<b>FERRIS-SMITH</b> , pinze chirurgiche	42	<b>GORNEY</b> , elevatore con aspirazione	335
<b>FERRIS-SMITH</b> , pinze per seno sfenoidale	333	<b>GORNEY</b> , forbici per preparazioni	70
<b>FINSEN</b> , divaricatori autostatici	149	<b>GORNEY-FREEMAN</b> , forbici per face-lift	69
<b>FISCH</b> , dissettori	295	<b>GRAEFE</b> , divaricatori sottili	136
<b>FISCHER</b> , bisturi per tonsille	247	<b>GRAZIL</b> , forbici per chirurgia	63
Fissatele	30, 31	<b>GREEN-SENN</b> , divaricatori sottili	140
<b>FOERSTER-BALLENGER</b> , pinze per spugne	133, 134	<b>GROSS</b> , uncini auricolari	290
<b>FOMON</b> , bisturi per operazioni nasali	334	<b>GROSS-MAIER</b> , pinze per polipi	131, 132
<b>FOMON</b> , divaricatori sottile	344	<b>GRUBER</b> , specoli auricolari	278
<b>FOMON</b> , forbici nasale	73	<b>GRUENWALD (JANSEN)</b> , pinze nasali	52
<b>FOMON</b> , forbici per preparazioni	70	<b>GUEDEL</b> , canule tracheali	244
<b>FOMON</b> , raspe nasale	341, 343	<b>GULEN</b> , cannule per irrigazione	335
<b>FOMON</b> , scalpelli	351	<b>GWYNNE</b> , dissettori	250
Forbici	59-94	<b>H</b>	
Forbici fine	74-77	<b>HAJEK</b> , martelli	302



<b>HAJEK-CLAUS</b> , pinze per seno sfenoidale	333	<b>HURD</b> , dissestori	248
<b>HAJEK-KOFFLER</b> , pinze per seno sfenoidale	332		
<b>HALLE</b> , curette taglienti	348	<b>I</b>	
<b>HALLE</b> , elevatori	337	Insufflatori	305
<b>HALLE</b> , forbici nasale	73	Interventi di lavoro, easyClean	396-399
<b>HALLE-HARTMANN</b> , specoli nasali	311	<b>ITERSON</b> , uncini tracheali	242
<b>HALLE-RITTER</b> , dilatatori per il seno frontale	335		
<b>HALLE-TIECK</b> , specoli nasali	311	<b>J</b>	
<b>HALSEY</b> , portaghi	103	<b>JACKSON</b> , laringoscopi a Luce fredda	178
<b>HALSEY</b> , portaghi tungsteno <b>TUC</b>	110	<b>JACKSON</b> , uncini tracheali	243
<b>HALSTED</b> , pinze emostatiche	22	<b>JACKSON-CHEVALIER</b> , canule tracheali	244
<b>HALSTED-MOSQUITO</b> , pinze emostatiche	22	<b>JACOBI</b> , aghi per legatura	125
<b>HARMS</b> , pinze per sutura	54	<b>JACOBSON</b> , portaghi tungsteno <b>TUC</b>	109
<b>HARRISON (PYE-SMITH)</b> , pinze per sterilizzazione	364	<b>JALASVIRTA</b> , pinze auricolare	52
<b>HARTMANN</b> , abbassalingua	238	<b>JANET</b> , siringhe	161
<b>HARTMANN</b> , canule per aspirazione	302	<b>JANSEN (GRUENDWALD)</b> , pinze nasali	52
<b>HARTMANN</b> , diapason	303	<b>JANSEN</b> , cucchiari auricolari	289
<b>HARTMANN</b> , pinze auricolari	283, 284	<b>JANSEN</b> , curette taglienti	214
<b>HARTMANN</b> , pinze emostatiche	21	<b>JANSEN</b> , divaricatori autostatici	149
<b>HARTMANN</b> , pinze per polipi nasali	315	<b>JANSEN</b> , elevatori	299
<b>HARTMANN</b> , pinze taglienti nasali	328	<b>JANSEN</b> , pinze nasale	52
<b>HARTMANN</b> , pinze taglienti per tonsille	255	<b>JANSEN-MIDDLETON</b> , pinze taglienti nasali	329
<b>HARTMANN</b> , pinze-sgorbie	223	<b>JANSEN-MIDDLETON</b> , pinze taglienti per il naso	329
<b>HARTMANN</b> , specoli auricolari	278	<b>JANSEN-ZAUFAL</b> , pinze-sgorbie	225
<b>HARTMANN</b> , specoli nasali	311	<b>JATHO</b> , pinze per il naso	331
<b>HARTMANN</b> , uncini auricolari	290	<b>JENNINGS</b> , apribocca	231
<b>HARTMANN-COLLIN</b> , divaricatori	146	<b>JEWELER</b> , pinze tungsteno <b>TUC</b>	56
<b>HARTMANN-FRENCH</b> , diapason	303	<b>JOBSON-HORNE</b> , portacotone	155
<b>HARTMANN-HALLE</b> , specoli nasali	311	<b>JOHNS-HOPKINS</b> , pinze bulldog	19
<b>HARTMANN-HOFFMANN</b> , pinze auricolari	284	<b>JOHNS-HOPKINS</b> , pinze per posizionare	19
<b>HARTMANN-NOYES</b> , pinze auricolari	284	<b>JONES</b> , fissatele	30
<b>HARTMANN-WULLSTEIN</b> , pinze auricolari	284	<b>JOSEPH</b> , bisturi per operazioni nasali	334
<b>HEATH-RICHTER</b> , pinze per agrafes	126	<b>JOSEPH</b> , divaricatori sottili	139, 344
<b>HEERMANN</b> , strumenti per lo stapes	297	<b>JOSEPH</b> , elevatori	337
<b>HEGAR-MAYO</b> , portaghi	105	<b>JOSEPH</b> , forbici per preparazioni	71
<b>HEGAR-MAYO</b> , portaghi tungsteno <b>TUC</b>	108	<b>JOSEPH</b> , raspe nasali	340
<b>HEGAR-MAYO-DELICATE</b> , portaghi	105	<b>JOSEPH</b> , strumenti per la plastica nasale	339, 356
<b>HEGAR-OLSEN</b> , portaghi	106	<b>JOSEPH-MASING</b> , elevatori	337
<b>HEGAR-OLSEN</b> , portaghi tungsteno <b>TUC</b>	113		
<b>HEGENBARTH</b> , pinze per agrafes	126	<b>K</b>	
<b>HEISTER</b> , apribocca	230	<b>KABIERSKE</b> , polverizzatore	305
<b>HENKE</b> , dissestori	248	<b>KALT</b> , micro-portaghi tungsteno <b>TUC</b>	117
<b>HENKE-SASS/WOLF</b> , adattatore	412	<b>KAYE</b> , forbici Face-lift	93
<b>HENLEY</b> , divaricatori autostatici	150	<b>KAZANJIAN</b> , pinze per il naso	331
<b>HERBERHOLD</b> , apribocca	235	<b>KELLY(RICHARDSON)</b> , divaricatori	145
<b>HESSBERG</b> , aghi per legatura	125	<b>KELLY</b> , pinze emostatiche	24
<b>HEYMANN</b> , forbici nasale	73	<b>KELLY-RANKIN</b> , pinze emostatiche	24
<b>HEYMANN</b> , pinze etmoidali e per il setto nasale	330	<b>KELMAN-McPHERSON</b> , pinze per sutura	53
<b>HEYMANN-KNIGHT</b> , pinze per polipi nasali	315	<b>KERRISON</b> , pinze per seno sfenoidale	332
<b>HIBBS SPRATT</b> , curette taglienti	213	<b>KILLIAN</b> , elevatori	338
<b>HIBBS</b> , osteotomi	200	<b>KILLIAN</b> , forbici per il setto nasale	272
<b>HIBBS</b> , scalpelli	200	<b>KILLIAN</b> , pinze per polipi nasali	315
<b>HILGER</b> , specchietti	269	<b>KILLIAN</b> , sgorbie	348
<b>HOEN</b> , elevatori	217	<b>KILLIAN</b> , specoli nasali	312
<b>HOFER</b> , retrattore per tonsille	251	<b>KILLIAN-CLAUS</b> , sgorbie	348
<b>HOKE</b> , osteotomi	197	<b>KILLIAN-EICKEN</b> , cannule per aspirazione	159
<b>HOLINGER</b> , laringoscopi	178	<b>KILNER(RAGNELL)</b> , forbici per preparazioni	71
<b>HOPKINS-JOHNS</b> , pinze bulldog	19	<b>KILNER</b> , divaricatori sottili	135, 345
<b>HOPKINS-JOHNS</b> , pinze per posizionare	19	<b>KILNER</b> , portaghi	103
<b>HORNE-JOBSON</b> , portacotone	155	<b>KILNER</b> , portaghi tungsteno <b>TUC</b>	110
<b>HOSPITAL-PROVIDENCE</b> , pinze emostatiche	23	<b>KILNER-DOUGHTY</b> , apribocca	232
<b>HOUSE</b> , canule per aspirazione	300	<b>KLEINERT-KUTZ</b> , divaricatori sottili	135
<b>HOUSE</b> , micro strumenti	295	<b>KLEINERT-KUTZ</b> , pinze-sgorbie	225
<b>HOUSE</b> , strumenti per lo stapes	296	<b>KLINIKUM BERLIN</b> , pinze serratubi	32
<b>HOUSE-GELFOAM</b> , pinza a pressione	307	<b>KNAPP</b> , divaricatori sottili	139
<b>HOWARTH</b> , elevatori	338	<b>KNIGHT</b> , pinze etmoidali e per il setto nasale	330
<b>HUBER</b> , manici universali	256	<b>KNIGHT-HEYMANN</b> , pinze per polipi nasali	315
<b>HUMBY</b> , dermatomo	99	<b>KOCHER</b> , divaricatori	142, 144
<b>HUMBY</b> , strumenti per la plastica nasale	346	<b>KOCHER</b> , sonde	246
<b>HUNTER</b> , pinze da presa	399		
<b>HUNTER</b> , pinze per schegge	48		
<b>HUPP</b> , uncini tracheali	243		



	Pagina		Pagina
<b>KOCHER-DELICATE</b> , pinze emostatiche	27	<b>LITTLER</b> , forbici fini	75
<b>KOCHER-LANGENBECK</b> , divaricatori	143	<b>LOCKHART-MUMMERY</b> , sonde	154
<b>KOCHER-OCHSNER</b> , pinze emostatiche	26	<b>LOPEZ-REINKE</b> , dissettori	249
<b>KOFFLER-HAJEK</b> , pinze per seno sfenoidale	332	<b>LORNA</b> , fissatele	31
<b>KRAUSE</b> , pinze intercambiabili	257	<b>LOVELACE-DIXON</b> , pinze emostatiche	28
<b>KRAUSE</b> , serranodi per polipi	282, 314	<b>LUBET-BARBON</b> , pinze per polipi nasali	315
<b>KRAUSE-VOSS</b> , serranodi per polipi	282, 314	<b>LUC</b> , pinze etmoidali e per il setto nasale	330
<b>KRESSNER</b> , strumenti per la plastica nasale	356	<b>LUCAE</b> , aghi per paracentesi	291
<b>KROENIG</b> , abbassalingua	239	<b>LUCAE</b> , diapason	303
<b>KROENLEIN</b> , pinze per afferrare	20	<b>LUCAE</b> , martelli	208
<b>KRONECKER</b> , aghi per legatura	125	<b>LUCAE</b> , pinze nasale	52
<b>KRONE-MARSCHIK</b> , pinze per tonsille	252	<b>LUCAE</b> , uncini auricolari	290
<b>KUHN-BOLGER</b> , curette taglienti	347	<b>LUCAS</b> , scalpelli	197
<b>KUTZ-KLEINERT</b> , divaricatori sottile	135	<b>LUER</b> , canule tracheali	244
<b>KUTZ-KLEINERT</b> , pinze-sgorbie	225	<b>LUER</b> , pinze-sgorbie	223
		<b>LUER</b> , uncini tracheali	243
<b>L</b>		<b>LUKENS</b> , uncini tracheali	242
		<b>LUNIATSCHECK</b> , dissettori	249
<b>LA FORCE</b> , adenotomi	354		
<b>LABORDE</b> , dilatatori	241	<b>M</b>	
<b>LACK</b> , abbassalingua	238	<b>MACKAY</b> , coltello falciforme	347
<b>LAHEY</b> , divaricatori	100	<b>MACKAY</b> , curette taglienti	347
<b>LAHEY</b> , pinze per gozzo	246	<b>MAGILL</b> , pinze per canule	171
<b>LAMBOTTE</b> , osteotomi	206	<b>MAIER-GROSS</b> , pinze per polipi	131, 132
<b>LAMBOTTE-MINI</b> , osteotomi	206	<b>MALTZ</b> , raspe nasale	340
Lamette de barba	100	Mancini per specchietti	268
Lampade frontali	181-185	Mancini porta elettrodi	404
<b>LANE</b> , fissatele	30	Mancini porta elettrodi con cavo	405
<b>LANE</b> , pinze anatomiche e chirurgiche	38	Manici per bisturi	96-98
<b>LANGE</b> , divaricatori sottili	344	Manici universali e pinze intercambiabili	256, 257
<b>LANGE</b> , pinze intercambiabili	257	Manicotti tre quarti e tre quarti	393
<b>LANGE</b> , pinze per agrafes	127	Maniglie, easyClean	394, 395
<b>LANGE</b> , pinze per polipi laringei	273	Marcatore per facelift	188
<b>LANGENBECK</b> , curette auricolari	289	<b>MARLIN</b> , materiale di sutura	250
<b>LANGENBECK</b> , ditali	230	<b>MARQUARDT</b> , pinze-sgorbie	224
<b>LANGENBECK</b> , elevatori	216	<b>MARSCHIK</b> , pinza tonsillare	250
<b>LANGENBECK</b> , periostotomi	215	<b>MARSCHIK-KRONE</b> , pinze per tonsille	252
<b>LANGENBECK</b> , portaghi	107	<b>MARTEL</b> , pinze per il cuoio capelluto	20
<b>LANGENBECK</b> , portaghi tungsteno <b>TUC</b>	116	Martelli	207-209, 302, 357
<b>LANGENBECK-DELICATE</b> , portaghi tungsteno <b>TUC</b>	116	<b>MARTIN</b> , specoli nasali	312
<b>LANGENBECK-KOCHER</b> , divaricatori	143	<b>MARTIN/BERCHTOLD</b> , cavi da connessione	406
<b>LANGENBECK-MINI</b> , divaricatori sottili	140	<b>MARTIN/BERCHTOLD</b> , mancini porta elettrodi	404
<b>LANGENBECK-RYDER</b> , portaghi tungsteno <b>TUC</b>	116	<b>MARTIN/BERCHTOLD</b> , mancini porta elettrodi con cavo	405
<b>LANGE-WILDE</b> , serranodi per polipi	282, 314	<b>MARTINI</b> , curette taglienti	214
Laringoscopi	163-166	<b>MARYLAND</b> , dissezione smusse	397
Laringoscopi a luce fredda	167-170, 178	<b>MASING</b> , bisturi per operazioni nasali	334
Laringoscopi operatori	172-180	<b>MASING</b> , divaricatori sottili	345
<b>LARKIN</b> , strumenti per lo stapes	296	<b>MASING</b> , elevatori	338
<b>LEMPERT</b> , curette	298	<b>MASING</b> , raspe nasale	341
<b>LEMPERT</b> , elevatori	298	<b>MASING</b> , scalpelli	352
<b>LEMPERT</b> , periostotomi	298	<b>MASING-JOSEPH</b> , elevatori	337
<b>LEMPERT</b> , pinze-sgorbie	224	<b>MASS-GENERAL-HOSPITAL</b> , portaghi	105
<b>LERICHE</b> , pinze emostatiche	23	<b>MASTIN</b> , pinza muscolare	246
<b>LEWIS</b> , raspe nasale	340, 343	<b>MATHIEU</b> , portaghi	106
<b>LEXER</b> , forbici per preparazioni	70	<b>MATHIEU</b> , portaghi tungsteno <b>TUC</b>	113
<b>LEXER</b> , forbici tungsteno <b>TUC</b>	90	<b>MATHIEU-DELICATE</b> , portaghi	106
<b>LEXER</b> , osteotomi	202, 203	<b>MATHIEU-DELICATE</b> , portaghi tungsteno <b>TUC</b>	114
<b>LEXER</b> , scalpelli	202, 203	<b>MATHIEU-RYDER VASCULAR</b> , portaghi tungsteno <b>TUC</b>	114
<b>LEXER-BABY</b> , forbici per preparazioni	71	<b>MATHIEU-RYDER</b> , portaghi tungsteno <b>TUC</b>	114
<b>LEXER-MINI</b> , osteotomi	202	<b>MAUNDER</b> , apribocca	230
<b>LEXER-MINI</b> , scalpelli	202	<b>MAYER-DAVIS</b> , apribocca	235
<b>LICHTENBERG</b> , portaghi tungsteno <b>TUC</b>	115	<b>MAYFIELD</b> , pinze-sgorbie	224
<b>LICHTWITZ</b> , tre quarti	156	<b>MAYO</b> , abbassalingua	239
<b>LISTER</b> , forbici tungsteno <b>TUC</b>	93	<b>MAYO</b> , forbici	65
<b>LISTER</b> , pinze per spugne	130	<b>MAYO</b> , forbici tungsteno <b>TUC</b>	87
<b>LISTON</b> , cesoie per ossa	226	<b>MAYO</b> , pinze per sterilizzazione	364
<b>LISTON-RUSKIN</b> , cesoie per ossa	227	<b>MAYO-HEGAR</b> , portaghi	105
<b>LISTON-WALTON</b> , cesoie per ossa	227	<b>MAYO-HEGAR</b> , portaghi tungsteno <b>TUC</b>	108
<b>LITTAUER</b> , forbici per legatura	77	<b>MAYO-HEGAR-DELICATE</b> , portaghi	105
<b>LITTAUER</b> , pinze depilatorie	51	<b>MAYO-STILLE</b> , forbici	65
<b>LITTAUER-LISTON</b> , cesoie per ossa	226	<b>MAYO-STILLE</b> , forbici tungsteno <b>TUC</b>	88
<b>LITTLE</b> , divaricatori	100		



<b>MC INDOE</b> , cesoie per ossa	227
<b>MC INDOE</b> , pinze anatomiche e chirurgiche	37
<b>MC INDOE</b> , strumenti per la plastica nasale	346
<b>MC INTOSH</b> , laringoscopi	163
<b>MC INTOSH</b> , laringoscopi Fibre Optic	167
<b>MC IVOR</b> , apribocca	234
<b>MCDONALD</b> , elevatori	217
<b>MCGEE</b> , micro pinze auricolari	286
<b>MCGEE</b> , uncini auricolari	293
<b>MCKENTY</b> , elevatori	337
<b>MCKERNAN</b> , pinze da presa	399
<b>MCKESSON</b> , apribocca	237
<b>MCPHERSON</b> , pinze per sutura	53
<b>MEAD</b> , martelli	208
<b>MEAD</b> , pinze-sgorbie	223
<b>METZENBAUM</b> , forbici per endoscopia	396, 400
<b>METZENBAUM</b> , forbici per preparazioni	65, 66
<b>METZENBAUM</b> , forbici tungsteno <b>TUC</b>	88, 89
<b>METZENBAUM</b> , portaghi tungsteno <b>TUC</b>	114
<b>METZENBAUM-BABY</b> , forbici per preparazioni	66
<b>METZENBAUM-DELICATE</b> , forbici per preparazioni	68
<b>METZENBAUM-DELICATE</b> , forbici tungsteno <b>TUC</b>	90, 91
<b>METZENBAUM-NELSON</b> , forbici per preparazioni	67
<b>MEYERDING</b> , divaricatori sottili	140
<b>MICHEL</b> , agrafes	127
<b>MICHEL</b> , pinze per agrafes	126
<b>MICHEL</b> , specchi laringei	271
Micro forbici	79-84
Micro pinze	46, 47
Micro pinze auricolari	284-288
Micro portaghi	117-123
Micro portaghi tungsteno <b>TUC</b>	74
Micro strumenti	295
<b>MICRO WULLSTEIN</b> , cannule per aspirazione	159
<b>MICRO-ADSON</b> , pinze anatomiche e chirurgiche	36
Microchirurgia endolaringea	259-266
<b>MICRO-MOSQUITO</b> , pinze emostatiche	22
<b>MICRO-RYDER</b> , portaghi tungsteno <b>TUC</b>	108
<b>MICROVASCULAR</b> , portaghi tungsteno <b>TUC</b>	109
<b>MIDDELDORPF</b> , divaricatori	145
<b>MIDDLETON-JANSEN</b> , pinze taglienti per il naso	329
<b>MILLARD(COTTLE)</b> , divaricatori sottili	345
<b>MILLER</b> , laringoscopi	165
<b>MILLER</b> , laringoscopi Fibre Optic	169
<b>MILLER-COLBURN</b> , raspe nasali	342
<b>MILLER-SENN</b> , divaricatori sottili	141
<b>MILLER-SENN-BABY</b> , divaricatori sottili	141
<b>MILLIGAN</b> , divaricatori autostatici	151
<b>MINI</b> , manici per bisturi	98
<b>MINI-FRIEDMAN</b> , pinze-sgorbie	222
<b>MINI-LAMBOTTE</b> , osteotomi	206
<b>MINI-LANGENBECK</b> , divaricatori sottili	140
<b>MINI-LEXER</b> , osteotomi	202
<b>MINI-LEXER</b> , scalpelli	202
<b>MINI-RUSKIN</b> , pinze-sgorbie	225
<b>MIXTER</b> , forbici per chirurgia	64
<b>MIXTER-BABY</b> , pinze per preparazioni e legature	29
<b>MIXTER-O'SHAUGNESSY</b> , pinze per preparazioni e legature	29
<b>MOD.BONN</b> , forbici fine	76
<b>MOD.TÜBINGEN</b> , pinze per sutura	54
<b>MOD.USA</b> , pinze anatomiche e chirurgiche	36
<b>MOD.WIEN</b> , specoli nasali	312
<b>MOD.WÜRZBURG</b> , apribocca	234
<b>MODELL BONN</b> , pinze per sutura	54
<b>MODELL TÜBINGEN</b> , pinze per sutura	54
<b>MOLDESTAD</b> , divaricatori sottili	137
<b>MOLLISON</b> , dissettori	249
<b>MOLLISON</b> , divaricatori autostatici	151
<b>MOLT</b> , apribocca	230
<b>MORITZ-SCHMIDT</b> , abbassalingua	238
<b>MOSHER-WAGENER</b> , tubo	243
<b>MOSQUITO-HALSTED</b> , pinze emostatiche	22

<b>MOSQUITO-MICRO</b> , pinze emostatiche	22
<b>MUCK</b> , coltelli	299
<b>MULDOON</b> , dilatatori per ductus salivarius	275
<b>MURRAY-CRILE</b> , portaghi	104
<b>MUSEUX</b> , pinze per tonsille	252
<b>MYLES</b> , cannule per irrigazione	335
<b>MYRTLE LEAF</b> , sonde	153

**N**

<b>NAGER</b> , retrattori per tonsille	251
<b>NASOPHARYNGOSCOPIO FLESSIBILE</b>	403
<b>NEGUS(BECKMANN)</b> , coltelli per vegetazioni adenoidee	353
<b>NEGUS</b> , elevatore con aspirazione	335
<b>NEGUS</b> , supporto contro-petto per apribocca	236
<b>NEIVERT</b> , osteotomi	352
<b>NEIVERT</b> , portaghi	103
<b>NEIVERT</b> , portaghi tungsteno <b>TUC</b>	110
<b>NEIVERT-ANDERSON</b> , osteotomi	352
<b>NEIVERT-COTTLE</b> , divaricatori sottili	345
<b>NELATON</b> , sonde	153
<b>NELSON-METZENBAUM</b> , forbici per preparazioni	67
<b>NEW ORLEANS</b> , portaghi tungsteno <b>TUC</b>	109
<b>NEWS</b> , uncini tracheali	243
<b>NIJMEGEN</b> , cannule per aspirazione	159
<b>NOLST-TRENITÉ JOSEPH</b> , strumenti per la plastica nasale	339
<b>NOLST-TRENITÉ</b> , osteotomi	350
<b>NORTHBENT</b> , forbici per legatura	78
<b>NOYES-HARTMANN</b> , pinze auricolari	284

**O**

<b>O'BRIAN</b> , forbici fine	76
<b>O'CONNOR</b> , divaricatori sottili	136
<b>O'SHAUGNESSY-MIXTER</b> , pinze per preparazioni e legature	29
<b>OBWEGESER</b> , divaricatori	143
<b>OBWEGESER</b> , osteotomi	352
Occhiali Nistagmo	186, 187
<b>OCHSNER-KOCHER</b> , pinze emostatiche	26
<b>OEHLER</b> , pinze tungsteno <b>TUC</b>	56
<b>OLSEN-HEGAR</b> , portaghi	106
<b>OLSEN-HEGAR</b> , portaghi tungsteno <b>TUC</b>	113
<b>OLYMPUS</b> , adattatore	412
Ortopedia	195-228
Osteotomi	349-352
Oto-/oftalmologia	193
Otoscopio, video	194
<b>OTOSKOP UNI</b>	193

**P**

<b>PARKER</b> , divaricatori	147
<b>PARTSCH</b> , martelli	208
<b>PARTSCH</b> , scalpelli	198
<b>PASSOW</b> , coltelli	299
<b>PAUFIQUE</b> , pinze per sutura	54
<b>PAULSEN</b> , cannule per irrigazione	335
<b>PEAN</b> , pinze per afferrare	20
<b>PEAN-DELICATE</b> , pinze emostatiche	27
<b>PEAN-ROCHESTER</b> , pinze emostatiche	25
<b>PEERS</b> , fissatele	31
<b>PEET</b> , pinze per schegge	50
<b>PENNINGTON</b> , pinze per afferrare	20
<b>PENNINGTON</b> , strumenti per la plastica nasale	339
Periostotomi	215, 216, 298
<b>PERWITZSCHKY</b> , forbici fine	74, 275
<b>PETERSEN-SMITH</b> , osteotomi	199
<b>PETERSEN-SMITH</b> , scalpelli	199
Pettine de metallo	364
<b>PIERCE</b> , strumenti per la plastica nasale	339
<b>PIFFARD</b> , curette taglienti	212
<b>PILCHER</b> , specoli nasali	312



	Pagina		Pagina
Pinza a pressione	307	<b>PRATT</b> , sonda per fistule	154
Pinza da introduzione per timpanostomia	307	<b>PRECISA</b> , sfigmomanometro	191
Pinza muscolare	246	<b>PRESBYTERIAN</b> , pinze serratubi	32
Pinze anatomiche e chirurgiche	34-42	<b>PRINCE</b> , forbici per tonsille	72
Pinze atrauma	55	<b>PROVIDENCE-HOSPITAL</b> , pinze emostatiche	23
Pinze auricolari	283, 284	Puntura	156-162
Pinze bulldog	18, 19	<b>PYE-SMITH (HARRISON)</b> , pinze per sterilizzazione	364
Pinze da presa	397	<b>PYNCHON-ANDREWS</b> , cannule per aspirazione	157
Pinze depilatorie	51		
Pinze etmoidali e per il setto nasale	330	<b>Q</b>	
pinze fissatrice	53	<b>QUIRE</b> , pinze auricolari	283
Pinze micro	46, 47		
Pinze nasali	52	<b>R</b>	
Pinze orologio	45	Raccordi	162
Pinze osteotomi	288, 320, 321, 332, 333	<b>RAGNELL(KILNER)</b> , forbici per preparazioni	71
Pinze per afferrare	43, 44, 397-400	<b>RAGNELL-DAVIS</b> , divaricatori sottili	141
Pinze per afferrare l'intestino	17	<b>RALK</b> , pinze per schegge	50
Pinze per afferrare tessuti	17	<b>RAMPLEY</b> , pinze per spugne	134
Pinze per agrafes	126, 127	<b>RANKIN-CRILE</b> , pinze emostatiche	24
Pinze per cannule	171	<b>RANKIN-KELLY</b> , pinze emostatiche	24
Pinze per gozzo	246	Raspe nasali	340-343
Pinze per il cuoio capelluto	28	Recipienti cilindrici	363
Pinze per il setto nasale ed etmoidali	330	<b>REICHERT</b> , strumenti per laringologia	272
Pinze per la Bi-Coagulazione	410	<b>REILL</b> , micro-portaghi	120
Pinze per laringo-broncoscopia	267	<b>REINKE-LOPEZ</b> , dissettori	249
Pinze per laringologia	230	Retratore per tonsille	226
Pinze per legatura	46, 47	<b>REVERDIN</b> , aghi	124
Pinze per legature con piattaforma	46, 47	<b>REYNOLDS</b> , forbici per preparazioni	72
Pinze per polipi	130-134	<b>RICHARDSON(KELLY)</b> , divaricatori	145
Pinze per polipi laringei	273	<b>RICHTER</b> , forbici per chirurgia	64
Pinze per polipi nasali	315	<b>RICHTER-HEATH</b> , pinze per agrafes	126
Pinze per posizionare	19	<b>RING</b> , apribocca	234
Pinze per preparazioni e legatura	29	<b>RIRAP</b> , stetoscopi	189
Pinze per raddrizzare il setto nasale	355	<b>RITTER-HALLE</b> , dilatatori per il seno frontale	335
Pinze per riposizione	228	<b>ROCHESTER-PEAN</b> , pinze emostatiche	25
Pinze per ritorcere fili <b>TUC</b>	116	<b>RÖDER</b> , ago per sutura tonsillare	250
Pinze per rompere le lamette	100	<b>ROEDER</b> , fissatele	31
Pinze per schegge	48-50	<b>ROGER</b> , elevatore per setto	336
Pinze per seno frontale	317	<b>ROGGE</b> , pinze per sterilizzazione	364
Pinze per seno sfenoidale	332, 333	<b>ROLLET</b> , divaricatori sottile	139
Pinze per sinuscopia	318-327	<b>ROSE</b> , uncinii tracheali	243
Pinze per spugne	130-134	<b>ROSEN</b> , aghi auricolari	292, 293
Pinze per sterilizzazione	364	<b>ROSEN</b> , coltelli	294
Pinze per sutura	53, 54, 126, 127	<b>ROSEN</b> , micro strumenti	295
Pinze per tamponi	131-134	<b>ROSER-KÖNIG</b> , apribocca	231
Pinze per tonsille	250, 252	<b>ROUX</b> , divaricatori	146
Pinze serratubi	32	<b>ROWE</b> , pinze per riposizione	228
Pinze taglienti nasali	327-329	<b>RUBIN</b> , osteotomi	351
Pinze taglienti per endoscopia	396	<b>RUBIN</b> , strumenti per la plastica nasale	356
Pinze taglienti per tonsille	255	Rubinetti	162
Pinze tungsteno <b>TUC</b>	56-58	<b>RUSKIN</b> , pinze-sgorbie	225
Pinze-sgorbie	222-225	<b>RUSKIN-LISTON</b> , cesoie per ossa	227
<b>PITHA</b> , apribocca	230	<b>RUSKIN-MINI</b> , pinze-sgorbie	225
<b>PLESTER</b> , cannule per aspirazione	159	<b>RUSS.MOD.</b> , pinze per afferrare tessuti	225
<b>PLESTER</b> , coltelli	294	<b>RYDER</b> , portaghi tungsteno <b>TUC</b>	108
<b>PLESTER</b> , divaricatori autostatici	152	<b>RYDER-LANGENBECK</b> , portaghi tungsteno <b>TUC</b>	116
<b>PLESTER</b> , micro strumenti	295	<b>RYDER-MATHIEU VASCULAR</b> , portaghi tungsteno <b>TUC</b>	114
<b>POLITZER</b> , aghi per paracentesi	291	<b>RYDER-MATHIEU</b> , portaghi tungsteno <b>TUC</b>	114
<b>POLITZER</b> , bisturi	291	<b>RYDER-MICRO</b> , portaghi tungsteno <b>TUC</b>	108
<b>POLITZER</b> , insufflatori	305		
<b>POLITZER</b> , specoli auricolari	278	<b>S</b>	
Polverizzatore	305	<b>SANVENERO</b> , forbici per preparazioni	71
<b>POOLE</b> , canule per aspirazione	158	<b>SAROT</b> , portaghi	104
<b>POOLE-BABY</b> , canule per aspirazione	158	<b>SAROT</b> , portaghi tungsteno <b>TUC</b>	111
Portacotone	154, 155	<b>SAUERBRUCH</b> , divaricatori	100
Portaghi	102-116	<b>SCALP-CONTOUR</b> , divaricatori autostatici	152
Portaghi micro	117-123	Scalpelli	348-352
Portaghi tungsteno <b>TUC</b>	108-119	Scatole per sterilizzare aghi	361
Portaghi, endoscopia	397	Scatole per strumenti	363
<b>POTTS-SMITH</b> , pinze anatomiche e chirurgiche	40		
<b>POTTS-SMITH</b> , pinze tungsteno <b>TUC</b>	56		
<b>PRATT</b> , curette taglienti	347		



<b>SCHAEDEL</b> , fissatele	30	<b>ST.CLAIR-THOMPSON</b> , coltelli p.vegetazioni adenoidee	354
<b>SCHÄFER</b> , divaricatori	358	<b>ST.CLAIR-THOMPSON</b> , specchio postrinoscopico	272
<b>SCHEDÉ</b> , curette taglienti	211	<b>ST.MARTIN</b> , pinze per sutura	53
<b>SCHEINMANN</b> , pinze intercambiabili	257	<b>STACKE</b> , sonde	153
<b>SCHINK</b> , dermatomo	99	<b>STAMMBERGER</b> , pinze per sinusopia	324
<b>SCHMEDEN</b> , pinze taglienti nasali	328	<b>STANDARD</b> , abbassalingua	239
<b>SCHMEDEN</b> , pinze taglienti per tonsille	255	<b>STANDARD</b> , forbici per chirurgia	62
<b>SCHMIDT-MORITZ</b> , abbassalingua	238	<b>STANDARD</b> , forbici tungsteno <b>TUC</b>	86, 87
<b>SCHOEMAKER</b> , forbici per gozzo	73	<b>STANDARD</b> , pinze anatomiche e chirurgiche	34
<b>SCHOENBORN</b> , uncini tracheali	242	<b>STELLBRINK</b> , pinze-sgorbie	222
<b>SCHUKNECHT(BARON)</b> , canule per aspirazione	300	<b>STERNBERG</b> , divaricatori per guance e labbra	238
<b>SCHUKNECHT</b> , coltelli	294	<b>STERNUM</b> , portagli tungsteno <b>TUC</b>	116
<b>SCHUHNECHT</b> , divaricatori autostatici	151	Stetoscopi	189, 190
<b>SCHUHNECHT</b> , strum. per piegare le protesi stapediale di filo	297	<b>STEVENS</b> , forbici oftalmologiche	77
<b>SCHUMACHER</b> , pinze intercambiabili	257	<b>STEVENS</b> , forbici tungsteno <b>TUC</b>	92
<b>SCHWECKENDICK-GOOD</b> , forbici per tonsille	72	<b>STIEGLITZ</b> , pinze per schegge	50
Scodelle	360, 363	<b>STIERLEN</b> , abbassalingua	241
<b>SEBILEAU</b> , elevatori	216	<b>STILLE</b> , osteotomi	201
<b>SECCO</b> , mancini per specchietti	268	<b>STILLE</b> , pinze anatomiche e chirurgiche	42
<b>SEIFFERT</b> , pinze intercambiabili	257	<b>STILLE</b> , scalpelli	201
<b>SELECT/ERBE</b> , cavi da connessione	406	<b>STILLE-MAYO</b> , forbici	65
<b>SEMKEN</b> , pinze anatomiche e chirurgiche	37, 38	<b>STILLE-MAYO</b> , forbici tungsteno <b>TUC</b>	88
<b>SEMKEN</b> , pinze tungsteno <b>TUC</b>	56	<b>STORZ</b> , adattatore	412
<b>SENN-GREEN</b> , divaricatori sottili	140	Strumenti per la plastica nasale	339, 346, 356
<b>SENNING(SCHWED.MODELL)</b> , portagli	105	Strumenti per lo stapes	296, 297
<b>SENNING(SCHWED.MODELL)</b> , portagli tungsteno <b>TUC</b>	109	Strumenti per sensibilità	188
<b>SENN-MILLER</b> , divaricatori sottili	141	Strumenti per tonsille	226
<b>SENN-MILLER-BABY</b> , divaricatori sottili	141	Strumento di sutura	107
<b>SEPTUM</b> , aghi per Septum	335	<b>STRÜMPEL</b> , pinze auricolari	284
Serranodi per polipi	314	<b>STRUYCKEN</b> , pinze per sinusopia	319
Serranodi per polipi	282, 314	<b>STRUYCKEN</b> , pinze taglienti nasali	328, 329
Serranodi per tonsille	254	<b>STRYKER</b> , adattatore	412
Set per tracheotomia	245	<b>SULLIVAN(BROPHY)</b> , forbici fine	75
<b>SEWALL</b> , curette	347	Super Cut forbici	61
Sfigmomanometro a mercurio	191	Supporto contro-petto per apribocca	236
Sgorbie	197-206, 299, 348	Sutura	101-128
<b>SHAMBAUGH</b> , uncini auricolari	292	<b>SYME</b> , aghi per legatura	124
<b>SHAMBAUGH-DERLACKI</b> , periostotomi	298		
<b>SHAPLEIGH</b> , curette auricolari	289	<b>T</b>	
<b>SHEA</b> , strumenti per lo stapes	296	<b>TABB</b> , coltelli	294
<b>SHEEHAN</b> , osteotomi	351	<b>TAKAHASHI</b> , pinze per sinusopia	319
<b>SHORTBENT</b> , forbici per legatura	78	<b>TAKAHASHI</b> , pinze taglienti per il naso	329
<b>SIEGLE</b> , specoli auricolari	281	<b>TAYLOR</b> , pinze anatomiche e chirurgiche	38
<b>SILVER</b> , dermatomi	100	<b>TAYLOR-CUSHING</b> , pinze tungsteno <b>TUC</b>	57
<b>SILVER</b> , osteotomi	352	<b>TERRIER</b> , pinze emostatiche	21
<b>SIMPLEX</b> , divaricatori per guance	238	<b>THIESS</b> , martelli	208
<b>SINUSCOPY</b> , trequarti	156	<b>THOMPSON-ST.CLAIR</b> , specchio postrinoscopico	272
Siringhe	161, 306	<b>THOREK</b> , forbici per preparazioni	70
Siringhe auricolari	306	<b>THUDICHUM(GOLDSMITH)</b> , specoli nasali	313
Sistema del contenitore	365-388	<b>TIECK-HALLE</b> , specoli nasali	311
<b>SLUDER-BALLENGER</b> , tonsillotomo	253	<b>TILLEY</b> , pinze auricolari	283
<b>SMITH-FERRIS</b> , pinze per seno sfenoidale	333	<b>TIVNEN</b> , pinze per tonsille	252
<b>SMITH-PETERSEN</b> , osteotomi	199	<b>TOBOLD</b> , abbassalingua	238
<b>SMITH-PETERSEN</b> , scalpelli	199	<b>TOENNIS</b> , portagli	107
<b>SNELLEN</b> , anse auricolari	290	<b>TOENNIS</b> , portagli tungsteno <b>TUC</b>	115
<b>SNITMAN</b> , divaricatori autostatici	149	<b>TOENNIS-ADSON-DELICATE</b> , forbici tungsteno <b>TUC</b>	93
Sonde	153-155, 274	<b>TOHOKU-JAPAN</b> , fissatele	31
Sonde esploratrici per ductus salivarius	274	Tonsillotomo	253
<b>SONNENSCHN</b> , specoli nasali	312	<b>TOYNBEE</b> , specoli auricolari	278
Specchi frontali	181, 183	Tracheotomi	245
Specchi laringei	271	<b>TRELAT</b> , elevatore periostale	336
Specchietti	269, 270	<b>TREPSAT</b> , forbici per face-lift	69
specchietti da bocca	269, 270	Trequarti	156, 241
Specchio, laringei	271	<b>TROELTSCH(WILDE)</b> , pinze auricolare	52
Specchio, postrinoscopico	272	<b>TROUSSEAU</b> , dilatatori	241
Specoli nasali	311-313	<b>TROUTMAN-CHRIS</b> , pinze per rompere le lamette	100
Speculum nasolaringeale	312	Tubi di ventilazione	307
<b>SPENCER</b> , forbici per legatura	77	<b>TÜBINGER MODELL</b> , divaricatori autostatici	152
<b>SPENCER-DELICATE</b> , forbici per legatura	77	<b>TÜBINGER</b> , tubi di ventilazione	307
<b>SPENCER-WELLS</b> , pinze emostatiche	21	<b>TUFFIER</b> , pinze per afferrare	20
<b>SPRATT</b> , curette taglienti	211	<b>TYDING</b> , pinze per tonsille	252
<b>ST.BARTHOLOMEW</b> , pinze per il naso	331		

	Pagina		Pagina
<b>TYDING</b> , serranodi per tonsille	254	<b>WISCONSIN(FOREGGER)</b> , laringoscopi	164
<b>U</b>		<b>WISCONSIN(FOREGGER)</b> , laringoscopi Fibre Optic	168
<b>UCKERMANN</b> , portacotone	155	<b>WOLF/HENKE-SASS</b> , adattatore	412
<b>UCKERMANN</b> , tracheotomi	241	<b>WULLSTEIN MICRO</b> , cannule per aspirazione	159
<b>UFFENORDE</b> , curette taglienti	348	<b>WULLSTEIN</b> , canule per aspirazione	300
Uncini	290	<b>WULLSTEIN</b> , coltelli	294
Uncini auricolari	290, 292, 293	<b>WULLSTEIN</b> , divaricatori autostatici	151
Uncini tracheali	242, 243	<b>WULLSTEIN</b> , elevatori	298
<b>UNI OTOSKOP</b> , astucci per diagnostica	193	<b>WULLSTEIN</b> , micro pinze auricolari	288
<b>UNI-ECONOM</b> , astucci per diagnostica	192	<b>WULLSTEIN-HARTMANN</b> , pinze auricolari	284
<b>UNIV.MINNESOTA</b> , abbassalingua	239	<b>WÜRZBURG</b> , dissettori	249
<b>UNIVERSAL</b> , pinze-sgorbie	222	<b>Y</b>	
<b>V</b>		<b>YANKAUER</b> , cannule per aspirazione	157
<b>VALLEYLAB</b> , cavi da connessione	406	<b>YANKAUER</b> , specoli nasali	312
<b>VALLEYLAB</b> , mancini porta elettrodi con cavo	405	<b>YANKAUER-WALTON</b> , cannule per aspirazione	157
<b>VERHOEVEN</b> , cannule per aspirazione	301	<b>YOUNG</b> , pinze tiralingua	240
Video-Otoscopio	194	<b>Z</b>	
<b>VISE</b> , pinze per legature	46	<b>ZAUFAL</b> , uncini auricolari	290
<b>VOLKMANN</b> , curette taglienti	210, 214	<b>ZAUFAL-JANSEN</b> , pinze-sgorbie	225
<b>VOLKMANN</b> , divaricatori	142	<b>ZIEGLER</b> , pinze depilatorie	51
<b>VOLTOLINI(DUPLAY)</b> , specoli nasali	313	<b>ZÖLLNER</b> , canule per aspirazione	300
<b>VOSS-KRAUSE</b> , serranodi	282, 314	Zoom-Adattatore	413
<b>W</b>			
<b>WACHENFELD</b> , pinze per agrafes	126		
<b>WAGENER</b> , uncini auricolari	290		
<b>WAGENER-MOSHER</b> , tubo	243		
<b>WAGNER</b> , forbici fine	74		
<b>WALSHAM</b> , pinze per raddrizzare il setto nasale	355		
<b>WALTER(AUFRICHT)</b> , strumenti per la plastica nasale	346		
<b>WALTER</b> , divaricatori sottili	141		
<b>WALTER</b> , osteotomi	351		
<b>WALTER</b> , scalpelli	351		
<b>WALTON</b> , forbici	76		
<b>WALTON-LISTON</b> , cesoie per ossa	227		
<b>WALTON-YANKAUER</b> , cannule per aspirazione	157		
<b>WANGENSTEEN</b> , pinze tungsteno <b>TUC</b>	58		
<b>WARTENBERG</b> , strumenti sensibilità	188		
<b>WATSON</b> , dermatomo	99		
<b>WATSON-WILLIAMS</b> , pinze taglienti nasali	327		
<b>WAUGH</b> , pinze per afferrare tessuti	43		
<b>WEBSTER</b> , portaghi	103		
<b>WEBSTER</b> , portaghi tungsteno <b>TUC</b>	110		
<b>WEERDA</b> , dilatatori	241		
<b>WEIL-BLAKESLEY</b> , pinze per sinuscopia	318, 319		
<b>WEIL-BLAKESLEY</b> , pinze taglienti nasali	327		
<b>WEINGÄRTNER</b> , pinze auricolari	284		
<b>WEITLANER</b> , divaricatori autostatici	150		
<b>WEITLANER-BABY</b> , divaricatori autostatici	150		
<b>WELLS-SPENCER</b> , pinze emostatiche	21		
<b>WEST</b> , scalpelli	348		
<b>WEST</b> , sgorbie	348		
<b>WESTMACOTT</b> , pinze per polipi nasali	315		
<b>WHITE</b> , pinze per tonsille	252		
<b>WHITEHEAD</b> , apribocca	232		
<b>WIEDER</b> , abbassalingua	238		
<b>WIENER</b> , raspe nasale	341		
<b>WILDE(TROELTSCH)</b> , pinze auricolare	52		
<b>WILDE-LANGE</b> , serranodi	282, 314		
<b>WILDER</b> , dilatatori per ductus salivarius	275		
<b>WILLIAMS-WATSON</b> , pinze taglienti per il naso	327		
<b>WILLIGER</b> , curette taglienti	214		
<b>WILLIGER</b> , elevatori	216		
<b>WILLIGER</b> , martelli	207		
<b>WILLIGER</b> , periostotomi	216		
<b>WILMER</b> , forbici per iridectomia	76		
<b>WINTER + IBE</b> , adattatore	412		





**nopa**<sup>®</sup> instruments  
traditionally modern

**nopa instruments**  
Medizintechnik GmbH  
Weilatten 7-9  
78532 Tuttlingen/Germany

Tel. +49 7462 9490-0  
Fax +49 7462 9490-90  
[info@nopa.de](mailto:info@nopa.de)  
[www.nopa.de](http://www.nopa.de)

Herstellung und Verkauf chirurgischer  
und endoskopischer Instrumente.  
Manufacture and Sales of Surgical  
and Endoscopic Instruments.

