



NÁSTROJE A IMPLANTÁTY PRO TRAUMATOLOGII

**INSTRUMENTS AND IMPLANTS
FOR TRAUMATOLOGY**



MEDIN, a.s.
Vlachovická 619
Nové Město na Moravě
CZ 592 31
Czech Republic
IČ 43378030
DIČ CZ43378030

PRODEJ ČESKÁ REPUBLIKA
tel.: 566 684 327
fax: 566 684 384
e-mail: prodej@medin.cz

EXPORT
phone: +420 566 684 371
fax: +420 566 684 385
e-mail: export@medin.cz

www.medin.cz
www.medin.eu

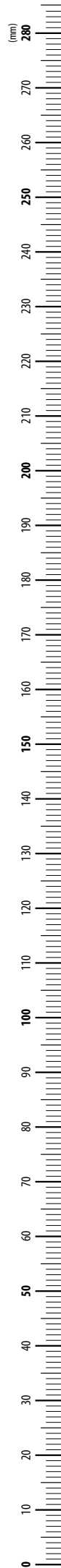



POUŽITÉ ZKRATKY A SYMBOLY

SSt	provedení SSt – materiál: nerezová ocel, dle ISO 5832-1
Ti	provedení TITAN – materiál: Ti6Al4V ELI, dle ISO 5832-3
∅	průměr
○	šestihran

USED ABBREVIATIONS AND SYMBOLS

SSt	SSt version – material: stainless steel, in accordance with ISO 5832-1
Ti	TITANIUM version – material: Ti6Al4V ELI, in accordance with ISO 5832-3
∅	diameter
○	hexagon

NÁSTROJE A IMPLANTÁTY PRO TRAUMATOLOGII

© 2018 MEDIN, a.s.; Všechna práva vyhrazena.

Dokument je určen pro obchodní účely MEDIN, a.s., údaje zde uvedené jsou informativního charakteru.

Žádná část tohoto dokumentu nesmí být reprodukována nebo publikována v jakékoliv formě bez předchozího souhlasu MEDIN, a.s.

Zobrazení produktů odpovídá aktuálnímu stavu v době vydání tohoto dokumentu. Změny technických parametrů z důvodu dalšího vývoje jsou vyhrazeny.

Tiskové a typografické chyby jsou vyhrazeny.

INSTRUMENTS AND IMPLANTS FOR TRAUMATOLOGY

© 2018 MEDIN, a.s.; All rights reserved.

This document should be used for commercial purposes of MEDIN, a.s.; the data mentioned in the document has informative character.

No part of this document can be copied or published in any form without approval of MEDIN, a.s.

The product design may differ from those depicted in these illustrations at the date of issue. Adjustments, made from the reason of further developments of technical parameters, are reserved.

Printing and typographical errors are reserved.

Od zubních vrtáčků po špičkové traumatologické implantáty MEDIN

MEDIN, a.s., je tradičním českým výrobcem lékařských nástrojů a implantátů. Portfolio firmy tvoří produkty pro traumatologii, chirurgii, stomatologii a ortopedii. Společnost dodává své výrobky do desítek zemí celého světa.

Zahájení výroby a budování podniku Chirana

Budoucnost jedné z předních společností České republiky se začala psát dne 29. srpna 1948, kdy byl v Novém Městě na Moravě položen **základní kámen závodu Chirana**. V roce 1949 byla zahájena výroba zubních vrtáčků a fréz pro zubní laboratoře.



V únoru 1950 rozšířila Chirana své **portfolio o chirurgii**. Do výrobního programu bylo zařazeno 25 druhů nejběžnějších chirurgických nástrojů. Ve stejném roce Chirana **poprvé exportuje** své výrobky, a sice do Bulharska, Rumunska a Německa.



Roku 1957 byl podnik rozšířen začleněním firmy Diamantrob, která se zabývala patentově chráněnou výrobou diamantových nástrojů pro zubní lékaře. Chirana pod své vedení vzala také



firmu Pelc-Tyrolka a firmu Koutný, produkující speciální nástroje pro chirurgii. **V roce 1968 byl zřízen holding Chirana Nové Město.**



Počátkem 70. let dominovala snaha o rozšíření výroby. Výsledkem bylo více než 5 milionů vyrobených vrtáčků, počátkem 80. let až 9 milionů vrtáčků. Výroba pokrývala také přes 4 tisíce druhů chirurgických nástrojů.

Do výrobního programu byl v roce 1990 zařazen **obor traumatologie**.



Privatizace a vznik společnosti MEDIN

V roce 1992 byl státní podnik Chirana zařazen do první vlny privatizace a dne 24. března 1992 vznikla akciová společnost MEDIN, právní nástupce státního závodu Chirana. V té době byla firma MEDIN vlastněná 154 zaměstnanci podniku.



Dne 23. března 2006 koupila společnost MEDIN firmu WALTER Medica a následně ji přejmenovala na MEDIN Orthopaedics, a.s. Společnost MEDIN tím rozšířila své **portfolio o ortopedii**.

V roce 2010 byla založena v Rusku dceřiná společnost MEDIN RU. Společnost MEDIN se od roku 2011 prezentuje novým logem.



MEDIN získal v roce 2012 druhou dceřinou společnost, a sice založením firmy MEDIN Slovensko. V roce 2013 došlo k propojení obchodní sítě MEDIN s firmou ProSpon, spol. s r.o. a MEDIN se tak stal výhradním distributorem ortopedických výrobků společnosti ProSpon. Dne 14. března 2014 zvítězil MEDIN, a.s., v soutěži Česká inovace v kategorii Inovativní firma. Ocenění se váže k patentovanému patnímu hřebu C-NAIL.

Školení lékařů

Vedle vlastní kvalitní výzkumné a vývojové základny je nezbytným předpokladem inovativnosti firmy a uplatnění svých produktů v náročných podmínkách trhu schopnost poskytovat kvalitní doprovodné služby. Jednou z těchto služeb, kterým se společnost MEDIN úspěšně věnuje, je pořádání odborných školení, praktických workshopů a seminářů zejména pro mladé lékaře a další zdravotnický personál. Tato vzdělávání probíhají v úzké spolupráci s firmou SOGGIORNO, s.r.o., v rámci celoživotního vzdělávání zdravotníků formou výuky operačních postupů s novými nebo inovovanými produkty firmy. Odborné semináře vedou špičkoví a vysoce uznávaní lékaři zejména v oborech traumatologie, ortopedie a chirurgie, s nimiž se firmě podařilo navázat úspěšnou dlouhodobou spolupráci. Školení je zajišťováno ve školicím středisku přímo v areálu společnosti MEDIN nebo v prostředí klienta.



Jaké hodnoty vám předáváme společně s výrobky?



Každý nástroj či implantát projde během zpracování rukama řady lidí a jeho výroba trvá až několik hodin. Nese tak s sebou i kus naší filozofie a základních hodnot.

*Kompletní nákup chirurgických nástrojů.
Ze široké nabídky firmy MEDIN jsme si
dokázali velmi dobře vybrat."*

*Mgr. Renáta Michalíčková, staniční sestra
op. sálů, Thomayerova nemocnice Praha*

Užitná hodnota výrobku

Celá cesta výrobku, od vlastního vývoje po distribuci, má jediný cíl. Dát lékařům do rukou kvalitní nástroj, který usnadní operační zákrok a pomůže při jejich vlastní práci.

"MEDIN instruments are good quality and long life. Most of the items prices are reasonable. We have been dealing with MEDIN for 6 years."

A. A. Zahar, Sala Medical, Oman

Zákazník

Našimi konečnými zákazníky jsou lékaři a zdravotní sestry z oborů chirurgie, traumatologie, ortopedie a stomatology. Snažíme se, aby řešení, která zákazníkům přinášíme, co nejvíce kopírovala jejich potřeby.



Testování nového instrumentária

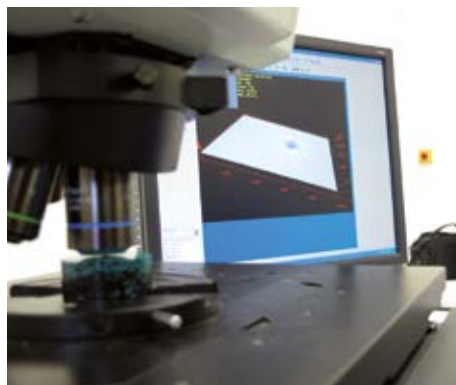

Zkoušky tvrdosti výrobku

"Komunikace je na velké úrovni a skoro vše vyřídí jeden telefonát a to s velkou ochotou."

*Markéta Adamová, staniční sestra ORT
op. sály, Nemocnice Rudolfa a Stefanie Benešov*

Naše okolí

Uvědomujeme si, že každá lidská činnost přináší změny v životním prostředí. Proto aplikujeme systém environmentálního managementu EMS. V rámci modelu Plan – Do – Check – Act Cycle neustále zkoumáme jednotlivé postupy ve firmě a hledáme ekologicky šetrnější varianty.



Sídlo naší společnosti se nachází v Novém Městě na Moravě, v dějišti řady sportovních událostí



From tooth drills to top-class traumatology implants MEDIN

MEDIN, a.s., is a traditional Czech producer of medical instruments and implants. The company's portfolio consists of products for traumatology, surgery, dentistry and orthopaedics. The company exports its products to dozens of countries around the world.

The start of production and building Chirana

The future of one of the leading companies in the Czech Republic began on 29 August 1948, when the **foundation stone of the** Chirana works was laid in Nové Město na Moravě. In 1949, production started on dental drills and milling cutters for dental laboratories.



In February 1950 Chirana expanded its **portfolio to surgery**. 25 of the most common surgical instruments were included in the production programme. In the same year Chirana **first exported** its products, namely to Bulgaria, Romania and Germany.



In 1957 the company expanded by incorporating Diamantrob, which was involved in the patented production of diamond tools for dentists. Chirana



also took Pelc-Tyrolka and Koutný, companies producing special tools for surgery, under its management. **The Chirana Nové Město holding was set up in 1968.**



The early 1970s were dominated by an endeavour to expand production. The result was the manufacture of over 5 million drills, in the early 80's this had increased to 9,000,000 drills. Production covered over 4,000 kinds of surgical instruments. The field of traumatology was introduced into the production programme in 1990.



Privatization and the emergence of MEDIN

In 1992, the state enterprise Chirana was included in the first wave of privatization and on 24 March 1992 the joint-stock company MEDIN was founded, the legal successor to the state-owned Chirana. At the time, MEDIN was owned by 154 company employees.



On 23 March 2006, MEDIN bought WALTER Medica and subsequently changed its name to MEDIN Orthopaedics, a.s. This allowed MEDIN to expand its **portfolio to orthopaedics.**

In 2010 a subsidiary, MEDIN RU, was founded in Russia. Since 2011 MEDIN has had a new logo.



In 2012 MEDIN gained a second subsidiary, namely through the founding of MEDIN Slovensko. In 2013 the MEDIN business network was linked to ProSpon, spol. s r.o. and MEDIN became the exclusive distributor of orthopaedic products for ProSpon. On 14 March 2014 MEDIN, a.s., won the Czech Innovation contest in the Innovative Company category. The award is for C-NAIL a patented calcaneal nail.

Training doctors

Besides its high-quality research and development programme, the provision of good-quality services is a prerequisite of a company's innovation and its ability to sell its products in the demanding conditions of today's market. One of these services, which MEDIN has had great success in, is the organization of professional training, practical workshops and seminars especially for young physicians and other medical personnel. This training takes place in close cooperation with SOGGIORNO, s.r.o., as part of lifelong education for health care professionals and takes the form of training in operating procedures with new or innovated products from the company. Professional seminars are led by leading and highly respected doctors, in particular in the fields of orthopaedics, traumatology and surgery, with whom the company has been able to establish successful, long-term cooperation. Training is provided in the training centre directly at MEDIN or at the client's premises.



What is the added value we offer with our products?



During processing, each instrument or implant passes through the hands of a number of people and takes up to several hours to produce. As such it carries a part of our philosophy and basic principles with it.

"Our operating theatres are brand new which meant purchasing a full range of surgical instruments. We were spoilt for choice from the wide offer range provided by MEDIN."

MSc Renáta Michaličková, Head Nurse for operating theatre at Thomayer's Hospital, Prague.

Customer

Our end customers are doctors and nurses from the fields of surgery, traumatology, orthopaedics and stomatology. We try to ensure that the solutions we deliver to customers match their needs as closely as possible.



Testing of new instrumentaria

Useful product value

Throughout the journey of making a product, from actual development right up until distribution, there is only one goal – to provide doctors with a quality instrument which will facilitate the operation procedure and assist them in their own work.

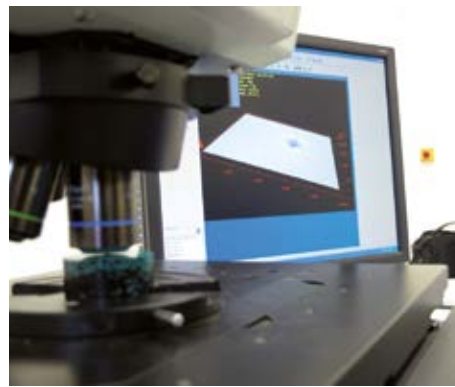

Tests on product hardness

"Communication is of the highest level and is almost always dealt with over one phone call and with a great sense of willingness"

Markéta Adamová, Head Nurse ORT operating theatre, Rudolf and Stephanie Hospital, Benešov

"MEDIN instruments are good quality and long lasting. Most prices of items are reasonable. We have been dealing with Medin for 6 years."

A. A. Zahar, Sala Medical, Oman

Our surroundings

We are aware that all human activity is accompanied by changes in our environment. For this reason we have put in place a system of environmental management called EMS. As part of our Plan – Do – Check – Act Cycle model, we are constantly exploring individual processes in the company and looking for options which demonstrate greater consideration to the environment.



Our head offices are located in Nové Město na Moravě, venue of sporting events



A

ŠROUBY KOSTNÍ
BONE SCREWS

B

DRÁTY A DROBNÉ IMPLANTÁTY
WIRES AND SMALL IMPLANTS

C

DLAHY ÚHLOVĚ STABILNÍ
ANGULARLY STABLE PLATES

D

DLAHY
PLATES

E

HŘEBY
NAILS

F

ŠROUBY SKLUZNÉ KOMPRESNÍ
DYNAMIC HIP AND CONDYLAR SCREWS

G

NÁSTROJE PRO TRAUMATOLOGII
INSTRUMENTS FOR TRAUMATOLOGY

A

ŠROUBY KOSTNÍ
BONE SCREWS

B

DRÁTY A DROBNÉ IMPLANTÁTY
WIRES AND SMALL IMPLANTS

C

DLAHY ÚHLOVĚ STABILNÍ
ANGULARLY STABLE PLATES

D

DLAHY
PLATES

E

HŘEBY
NAILS

F

ŠROUBY SKLUZNÉ KOMPRESNÍ
DYNAMIC HIP AND CONDYLAR SCREWS

G

NÁSTROJE PRO TRAUMATOLOGII
INSTRUMENTS FOR TRAUMATOLOGY

ŠROUBY KOSTNÍ
BONE SCREWS



A

ŠROUBY KOSTNÍ BONE SCREWS



Šrouby kostní

Šrouby kostní kortikální

Šrouby kostní spongiozní

Šrouby kostní kortikální kanylované

Šrouby kostní spongiozní kanylované

Podložky šroubů kostních

Instrumentárium pro šrouby kostní

Instrumentárium na extrakci šroubů

Instrumentárium pro zavádění šroubů do pánve

Bone screws

Cortical bone screws

Cancellous bone screws

Canullated cortical bone screws

Canullated cancellous bone screws

Bone screw washers

Instruments for bone screws

Instruments for screws extraction

Instruments for screws insertion into the pelvis

A.1

1–3

4–5

6

6–7

8

9–20

21

22

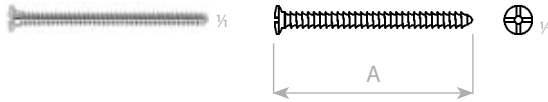
ŠROUBY KOSTNÍ KORTIKÁLNÍ
 CORTICAL BONE SCREWS

průměr závitu	thread diameter	2,0 mm
průměr jádra	core diameter	1,3 mm
průměr hlavy	head diameter	3,6 mm
vrták pro závit	drill bit for threaded hole	Ø 1,5 mm
vrták pro kluzný otvor	drill bit for gliding hole	Ø 2,0 mm
šroubovák	screwdriver	+ 3,5 mm

Šroub kostní kortikální HA 2
 Cortical bone screw HA 2

SSt	A
397 129 79 9780	4 mm
397 129 79 9790	6 mm
397 129 79 9800	8 mm
397 129 79 9810	10 mm
397 129 79 9820	12 mm
397 129 79 9830	14 mm
397 129 79 9840	16 mm
397 129 79 9850	18 mm
397 129 79 9860	20 mm
397 129 79 9870	22 mm
397 129 79 9880	24 mm
397 129 79 9890	26 mm
397 129 79 9900	28 mm
397 129 79 9910	30 mm
397 129 79 9920	32 mm
397 129 79 9930	34 mm
397 129 79 9940	36 mm
397 129 79 9950	38 mm

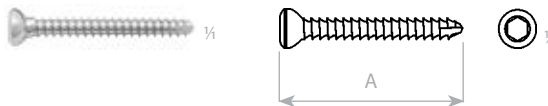

průměr závitu	thread diameter	2,7 mm
průměr jádra	core diameter	1,9 mm
průměr hlavy	head diameter	5,0 mm
vrták pro závit	drill bit for threaded hole	Ø 2,0 mm
vrták pro kluzný otvor	drill bit for gliding hole	Ø 2,7 mm
šroubovák	screwdriver	Ø 2,5 mm

Šroub kostní kortikální samořezný HA 2,7
 Self-tapping cortical bone screw HA 2.7

SSt	A	
397 129 79 5101	397 129 79 5104	8 mm
397 129 79 5111	397 129 79 5114	10 mm
397 129 79 5121	397 129 79 5124	12 mm
397 129 79 5131	397 129 79 5134	14 mm
397 129 79 5141	397 129 79 5144	16 mm
397 129 79 5151	397 129 79 5154	18 mm
397 129 79 5161	397 129 79 5164	20 mm
397 129 79 5171	397 129 79 5174	22 mm
397 129 79 5181	397 129 79 5184	24 mm
397 129 78 6101	397 129 78 6104	26 mm
397 129 78 6111	397 129 78 6114	28 mm
397 129 78 6121	397 129 78 6124	30 mm
397 129 78 6131	397 129 78 6134	32 mm
397 129 78 6141	397 129 78 6144	34 mm
397 129 78 6151	397 129 78 6154	36 mm
397 129 78 6161	397 129 78 6164	38 mm
397 129 78 6171	397 129 78 6174	40 mm

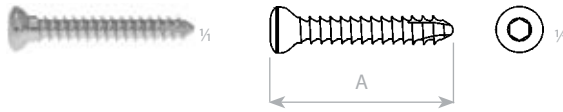
ŠROUBY KOSTNÍ KORTIKÁLNÍ
CORTICAL BONE SCREWS

průměr závitu	thread diameter	3,5 mm
průměr jádra	core diameter	2,4 mm
průměr hlavy	head diameter	6,0 mm
vrták pro závit	drill bit for threaded hole	Ø 2,5 mm
vrták pro kluzný otvor	drill bit for gliding hole	Ø 3,5 mm
šroubovák	screwdriver	Ø 2,5 mm

Šroub kostní kortikální samořezný HA 3,5
Self-tapping cortical bone screw HA 3.5

SSt	Ti	A
397 129 79 5201	397 129 79 5204	8 mm
397 129 79 5211	397 129 79 5214	10 mm
397 129 79 5221	397 129 79 5224	12 mm
397 129 79 5231	397 129 79 5234	14 mm
397 129 79 5241	397 129 79 5244	16 mm
397 129 79 5251	397 129 79 5254	18 mm
397 129 79 5261	397 129 79 5264	20 mm
397 129 79 5271	397 129 79 5274	22 mm
397 129 79 5281	397 129 79 5284	24 mm
397 129 79 5291	397 129 79 5294	26 mm
397 129 79 5301	397 129 79 5304	28 mm
397 129 79 5311	397 129 79 5314	30 mm
397 129 79 5321	397 129 79 5324	32 mm
397 129 79 5331	397 129 79 5334	34 mm
397 129 79 5341	397 129 79 5344	36 mm
397 129 79 5351	397 129 79 5354	38 mm
397 129 79 5361	397 129 79 5364	40 mm
397 129 79 5371	397 129 79 5374	42 mm
397 129 79 5441	397 129 79 5444	44 mm
397 129 79 5451	397 129 79 5454	46 mm
397 129 79 5461	397 129 79 5464	48 mm
397 129 79 5391	397 129 79 5394	50 mm
397 129 79 5401	397 129 79 5404	55 mm
397 129 79 5411	397 129 79 5414	60 mm
397 129 79 5421	397 129 79 5424	65 mm
397 129 79 5431	397 129 79 5434	70 mm

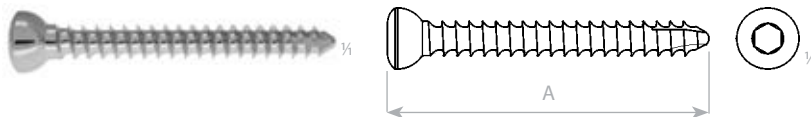

průměr závitu	thread diameter	4,5 mm
průměr jádra	core diameter	3,0 mm
průměr hlavy	head diameter	8,0 mm
vrták pro závit	drill bit for threaded hole	Ø 3,2 mm
vrták pro kluzný otvor	drill bit for gliding hole	Ø 4,5 mm
šroubovák	screwdriver	Ø 3,5 mm

Šroub kostní kortikální samořezný HA 4,5
Self-tapping cortical bone screw HA 4.5

SSt	Ti	A
397 129 79 9421	397 129 79 9424	14 mm
397 129 79 9431	397 129 79 9434	16 mm
397 129 79 9441	397 129 79 9444	18 mm
397 129 79 5521	397 129 79 5524	20 mm
397 129 79 9451	397 129 79 9454	22 mm
397 129 79 9461	397 129 79 9464	24 mm
397 129 79 5541	397 129 79 5544	26 mm
397 129 79 9471	397 129 79 9474	28 mm
397 129 79 5551	397 129 79 5554	30 mm
397 129 79 9481	397 129 79 9484	32 mm
397 129 79 9491	397 129 79 9494	34 mm
397 129 79 5571	397 129 79 5574	36 mm
397 129 79 9501	397 129 79 9504	38 mm
397 129 79 5581	397 129 79 5584	40 mm
397 129 79 9511	397 129 79 9514	42 mm
397 129 79 9521	397 129 79 9524	44 mm
397 129 79 9531	397 129 79 9534	46 mm
397 129 79 9541	397 129 79 9544	48 mm
397 129 79 5601	397 129 79 5604	50 mm
397 129 79 9551	397 129 79 9554	52 mm
397 129 79 9561	397 129 79 9564	54 mm
397 129 79 9571	397 129 79 9574	56 mm
397 129 79 9581	397 129 79 9584	58 mm
397 129 79 5621	397 129 79 5624	60 mm
397 129 79 5631	397 129 79 5634	65 mm
397 129 79 5641	397 129 79 5644	70 mm
397 129 79 5651	397 129 79 5654	75 mm
397 129 79 5661	397 129 79 5664	80 mm
397 129 79 5671	397 129 79 5674	85 mm
397 129 79 5681	397 129 79 5684	90 mm
397 129 79 5691	397 129 79 5694	95 mm
397 129 79 5701	397 129 79 5704	100 mm
397 129 79 5711	397 129 79 5714	105 mm
397 129 79 5721	397 129 79 5724	110 mm

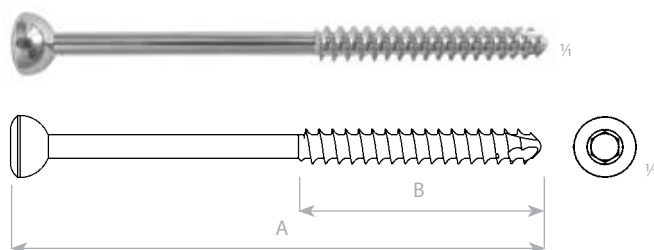
ŠROUBY KOSTNÍ KORTIKÁLNÍ
 CORTICAL BONE SCREWS

průměr závitu	thread diameter	4,5 mm
průměr dřívku	shank diameter	3,0 mm
průměr jádra	core diameter	3,0 mm
průměr hlavy	head diameter	8,0 mm
vrták pro závit	drill bit for threaded hole	Ø 3,2 mm
vrták pro kluzný otvor	drill bit for gliding hole	Ø 3,2 mm
šroubovák	screwdriver	Ø 3,5 mm

Šroub kostní maleolární samořezný HA 4,5
 Self-tapping malleolar bone screw HA 4.5

SSt	A	B
397 129 79 7100	25 mm	10 mm
397 129 79 7110	30 mm	12 mm
397 129 79 7120	35 mm	15 mm
397 129 79 7130	40 mm	17 mm
397 129 79 7140	45 mm	20 mm
397 129 79 7150	50 mm	22 mm
397 129 79 7160	55 mm	25 mm
397 129 79 7170	60 mm	27 mm
397 129 79 7180	65 mm	30 mm
397 129 79 7190	70 mm	32 mm

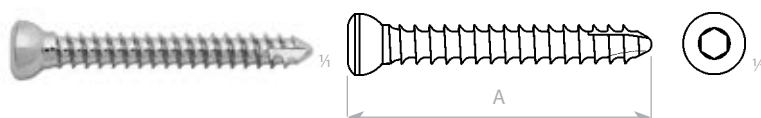

průměr závitu	thread diameter	5,0 mm
průměr jádra	core diameter	3,5 mm
průměr hlavy	head diameter	8,0 mm
vrták pro závit	drill bit for threaded hole	Ø 3,75 mm
vrták pro kluzný otvor	drill bit for gliding hole	Ø 5,0 mm
šroubovák	screwdriver	Ø 3,5 mm

Šroub kostní kortikální samořezný HA 5
 Self-tapping cortical bone screw HA 5

SSt	Ti	A
397 129 77 3851	397 129 77 3854	20 mm
397 129 77 3861	397 129 77 3864	25 mm
397 129 77 3871	397 129 77 3874	30 mm
397 129 77 3881	397 129 77 3884	35 mm
397 129 77 3891	397 129 77 3894	40 mm
397 129 77 3901	397 129 77 3904	45 mm
397 129 77 3911	397 129 77 3914	50 mm
397 129 77 3921	397 129 77 3924	55 mm
397 129 77 3931	397 129 77 3934	60 mm
397 129 77 3941	397 129 77 3944	65 mm
397 129 77 3951	397 129 77 3954	70 mm
397 129 77 3961	397 129 77 3964	75 mm
397 129 77 3971	397 129 77 3974	80 mm
397 129 77 3981	397 129 77 3984	90 mm
397 129 77 3991	397 129 77 3994	100 mm

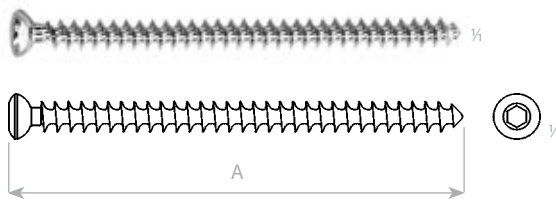
ŠROUBY KOSTNÍ SPONGIOZNÍ
CANCELLOUS BONE SCREWS

průměr závitu	thread diameter	4,0 mm
průměr jádra	core diameter	1,9 mm
průměr hlavy	head diameter	6,0 mm
závitník	tap	HB 4
vrták pro závit	drill bit for threaded hole	Ø 2,5 mm
šroubovák	screwdriver	Ø 2,5 mm

Šroub kostní spongiozní HB 4
Cancellous bone screw HB 4

SSt	Ti	A
397 129 79 6000	397 129 79 6003	14 mm
397 129 79 6010	397 129 79 6013	16 mm
397 129 79 6020	397 129 79 6023	18 mm
397 129 79 6030	397 129 79 6033	20 mm
397 129 79 6040	397 129 79 6043	22 mm
397 129 79 6050	397 129 79 6053	24 mm
397 129 79 6060	397 129 79 6063	26 mm
397 129 79 6070	397 129 79 6073	28 mm
397 129 79 6080	397 129 79 6083	30 mm
397 129 79 6090	397 129 79 6093	32 mm
397 129 79 6630	397 129 79 6633	34 mm
397 129 79 6640	397 129 79 6643	36 mm
397 129 79 6650	397 129 79 6653	38 mm
397 129 79 6110	397 129 79 6113	40 mm
397 129 79 6660	397 129 79 6663	42 mm
397 129 79 6670	397 129 79 6673	44 mm
397 129 79 6680	397 129 79 6683	46 mm
397 129 79 6690	397 129 79 6693	48 mm
397 129 79 6130	397 129 79 6133	50 mm
397 129 79 6140	397 129 79 6143	55 mm
397 129 79 6150	397 129 79 6153	60 mm

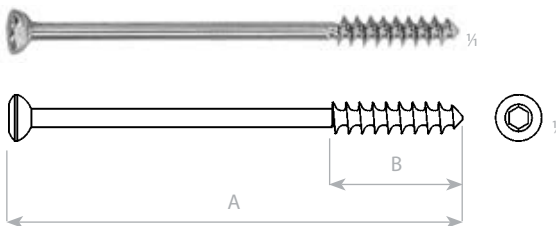

průměr závitu	thread diameter	4,0 mm
průměr dráku	shank diameter	2,4 mm
průměr jádra	core diameter	1,9 mm
průměr hlavy	head diameter	6,0 mm
závitník	tap	HB 4
vrták pro závit	drill bit for threaded hole	Ø 2,5 mm
šroubovák	screwdriver	Ø 2,5 mm

Šroub kostní spongiozní HB 4
Cancellous bone screw HB 4

SSt	A	B
397 129 79 6200	10 mm	5 mm
397 129 79 6210	12 mm	5 mm
397 129 79 6220	14 mm	5 mm
397 129 79 6230	16 mm	6 mm
397 129 79 6240	18 mm	7 mm
397 129 79 6250	20 mm	8 mm
397 129 79 6260	22 mm	9 mm
397 129 79 6270	24 mm	10 mm
397 129 79 6280	26 mm	12 mm
397 129 79 6290	28 mm	14 mm
397 129 79 6300	30 mm	14 mm
397 129 79 6310	32 mm	14 mm
397 129 77 4200	34 mm	14 mm
397 129 77 4210	36 mm	14 mm
397 129 77 4220	38 mm	14 mm
397 129 79 6330	40 mm	14 mm
397 129 77 4230	42 mm	15 mm
397 129 77 4240	44 mm	15 mm
397 129 77 4250	46 mm	15 mm
397 129 77 4260	48 mm	15 mm
397 129 79 6350	50 mm	15 mm
397 129 79 6360	55 mm	16 mm
397 129 79 6370	60 mm	16 mm

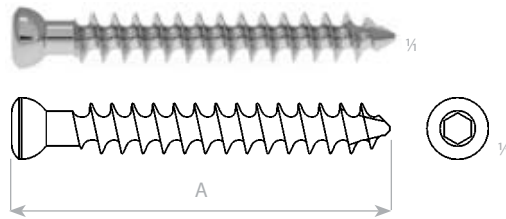
ŠROUBY KOSTNÍ SPONGIOZNÍ
 CANCELLOUS BONE SCREWS

průměr závitu	thread diameter	6,5 mm
průměr dřívku	shank diameter	4,5 mm
průměr jádra	core diameter	3,0 mm
průměr hlavy	head diameter	8,0 mm
vrták pro závit	drill bit for threaded hole	Ø 3,2 mm
vrták pro kluzný otvor	drill bit for gliding hole	Ø 4,5 mm
šroubovák	screwdriver	Ø 3,5 mm

Šroub kostní spongiozní samořezný HB 6,5
 Self-tapping cancellous bone screw HB 6.5

SSt	A
397 129 79 6401	25 mm
397 129 79 6411	30 mm
397 129 79 6421	35 mm
397 129 79 6431	40 mm
397 129 79 6441	45 mm
397 129 79 6451	50 mm

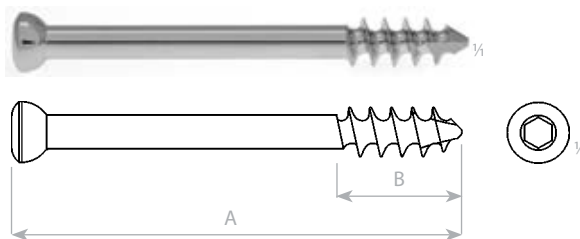

průměr závitu	thread diameter	6,5 mm
průměr dřívku	shank diameter	4,5 mm
průměr jádra	core diameter	3,0 mm
průměr hlavy	head diameter	8,0 mm
vrták pro závit	drill bit for threaded hole	Ø 3,2 mm
vrták pro kluzný otvor	drill bit for gliding hole	Ø 4,5 mm
šroubovák	screwdriver	Ø 3,5 mm

Šroub kostní spongiozní samořezný HB 6,5
 Self-tapping cancellous bone screw HB 6.5

SSt	A	B
397 129 79 6701	25 mm	16 mm
397 129 79 6711	30 mm	16 mm
397 129 79 6721	35 mm	16 mm
397 129 79 6731	40 mm	16 mm
397 129 79 6741	45 mm	16 mm
397 129 79 6751	50 mm	16 mm
397 129 79 6761	55 mm	16 mm
397 129 79 6771	60 mm	16 mm
397 129 79 6781	65 mm	16 mm
397 129 79 6791	70 mm	16 mm
397 129 79 6801	75 mm	16 mm
397 129 79 6811	80 mm	16 mm
397 129 79 6821	85 mm	16 mm
397 129 79 6831	90 mm	16 mm
397 129 79 6841	95 mm	16 mm
397 129 79 6851	100 mm	16 mm
397 129 79 6861	105 mm	16 mm
397 129 79 6871	110 mm	16 mm
397 129 79 6881	115 mm	16 mm
397 129 79 6891	120 mm	16 mm

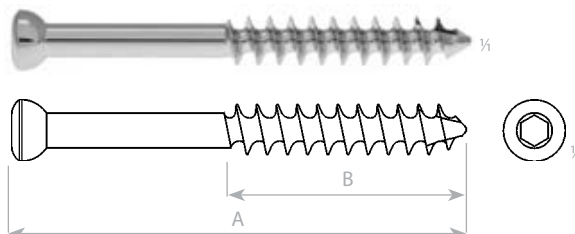

průměr závitu	thread diameter	6,5 mm
průměr dřívku	shank diameter	4,5 mm
průměr jádra	core diameter	3,0 mm
průměr hlavy	head diameter	8,0 mm
vrták pro závit	drill bit for threaded hole	Ø 3,2 mm
vrták pro kluzný otvor	drill bit for gliding hole	Ø 4,5 mm
šroubovák	screwdriver	Ø 3,5 mm

Šroub kostní spongiozní samořezný HB 6,5
 Self-tapping cancellous bone screw HB 6.5

SSt	A	B
397 129 79 6911	45 mm	32 mm
397 129 79 6921	50 mm	32 mm
397 129 79 6931	55 mm	32 mm
397 129 79 6941	60 mm	32 mm
397 129 79 6951	65 mm	32 mm
397 129 79 6961	70 mm	32 mm
397 129 79 6971	75 mm	32 mm
397 129 79 6981	80 mm	32 mm
397 129 79 6991	85 mm	32 mm
397 129 79 7001	90 mm	32 mm
397 129 79 7011	95 mm	32 mm
397 129 79 7021	100 mm	32 mm
397 129 79 7031	105 mm	32 mm
397 129 79 7041	110 mm	32 mm
397 129 79 7051	115 mm	32 mm
397 129 79 7061	120 mm	32 mm

ŠROUBY KOSTNÍ KORTIKÁLNÍ KANYLOVANÉ CANULATED CORTICAL BONE SCREWS

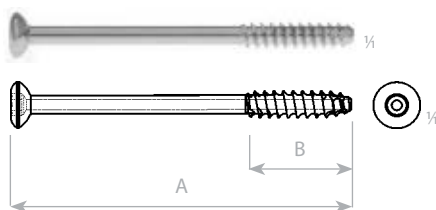

průměr závitů	thread diameter	3,5 mm
průměr dřívku	shank diameter	2,4 mm
průměr jádra	core diameter	2,4 mm
průměr hlavy	head diameter	6,0 mm
kanylovaný otvor	cannulation	1,3 mm
vrták pro závit	drill bit for threaded hole	Ø 2,4 mm
vrták pro kluzný otvor	drill bit for gliding hole	Ø 2,4 mm
šroubovák	screwdriver	Ø 2,5 mm
drát vodící	guide wire	Ø 1,2 mm

Šroub kostní kortikální kanylovaný samořezný HA 3,5 Self-tapping cannulated cortical bone screw HA 3.5

SSt	A	B
397 129 78 6251	10 mm	5 mm
397 129 78 6261	12 mm	5 mm
397 129 78 6271	14 mm	5 mm
397 129 78 6281	16 mm	6 mm
397 129 78 6291	18 mm	8 mm
397 129 78 6301	20 mm	8 mm
397 129 78 6311	22 mm	9 mm
397 129 78 6321	24 mm	10 mm
397 129 78 6331	26 mm	12 mm
397 129 78 6341	28 mm	14 mm
397 129 78 6351	30 mm	14 mm
397 129 78 6361	35 mm	14 mm
397 129 78 6371	40 mm	14 mm
397 129 78 6381	45 mm	15 mm
397 129 78 6391	50 mm	15 mm

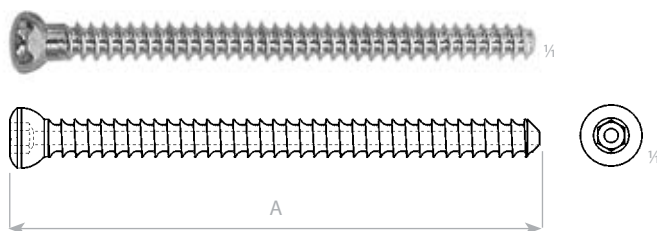

průměr závitů	thread diameter	5,0 mm
průměr jádra	core diameter	3,5 mm
průměr hlavy	head diameter	8,0 mm
kanylovaný otvor	cannulation	1,8 mm
závitník	tap	HA 5
vrták pro závit	drill bit for threaded hole	Ø 3,4 mm
vrták pro kluzný otvor	drill bit for gliding hole	Ø 5,0 mm
šroubovák	screwdriver	Ø 3,5 mm
drát vodící	guide wire	Ø 1,5 mm

Šroub kostní kortikální kanylovaný HA 5 Canulated cortical bone screw HA 5

SSt	A
397 129 79 7400	25 mm
397 129 79 7410	30 mm
397 129 79 7420	35 mm
397 129 79 7430	40 mm
397 129 79 7440	45 mm
397 129 79 7450	50 mm
397 129 79 7460	55 mm
397 129 79 7470	60 mm
397 129 79 7480	65 mm
397 129 79 7490	70 mm

ŠROUBY KOSTNÍ SPONGIOZNÍ KANYLOVANÉ CANULATED CANCELLOUS BONE SCREWS

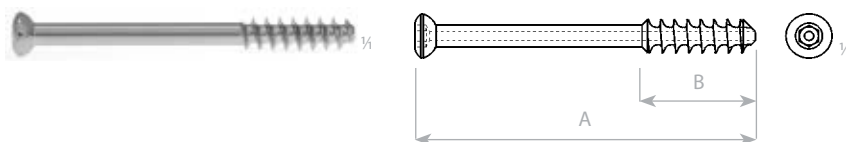

průměr závitů	thread diameter	4,5 mm
průměr dřívku	shank diameter	3,0 mm
průměr jádra	core diameter	2,4 mm
průměr hlavy	head diameter	6,0 mm
kanylovaný otvor	cannulation	1,2 mm
vrták pro závit	drill bit for threaded hole	Ø 3,4 mm
šroubovák	screwdriver	Ø 2,5 mm
drát vodící	guide wire	Ø 1,0 mm

Šroub kostní navikulární samořezný HB 4,5 Self-tapping navicular bone screw HB 4.5

SSt	A	B
397 129 79 7201	10 mm	5 mm
397 129 79 7211	12 mm	5 mm
397 129 79 7221	14 mm	5 mm
397 129 79 7231	16 mm	6 mm
397 129 79 7241	18 mm	7 mm
397 129 79 7251	20 mm	8 mm
397 129 79 7261	22 mm	9 mm
397 129 79 7271	24 mm	10 mm
397 129 79 7281	26 mm	12 mm
397 129 79 7291	28 mm	14 mm
397 129 79 7301	30 mm	14 mm
397 129 79 7311	35 mm	14 mm
397 129 79 7321	40 mm	14 mm
397 129 79 7331	45 mm	15 mm
397 129 79 7341	50 mm	15 mm

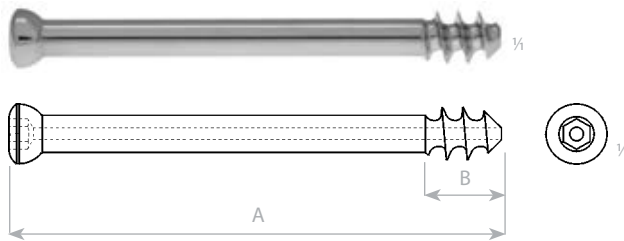
ŠROUBY KOSTNÍ SPONGIOZNÍ KANYLOVANÉ
 CANULATED CANCELLOUS BONE SCREWS

průměr závitu	thread diameter	7,0 mm
průměr dřívku	shank diameter	5,0 mm
průměr jádra	core diameter	3,5 mm
průměr hlavy	head diameter	8,0 mm
kanylovaný otvor	cannulation	1,8 mm
závitník	tap	HB 7
vrták pro závit	drill bit for threaded hole	Ø 4,0 mm
šroubovák	screwdriver	Ø 3,5 mm
drát vodící	guide wire	Ø 1,5 mm

Šroub kostní spongiozní HB 7
 Cancellous bone screw HB 7

SSt	A	B
397 129 70 9340	30 mm	10 mm
397 129 70 9350	35 mm	10 mm
397 129 70 9360	40 mm	10 mm
397 129 70 9370	45 mm	10 mm
397 129 70 9380	50 mm	10 mm
397 129 70 9390	55 mm	10 mm
397 129 70 9400	60 mm	10 mm
397 129 70 9410	65 mm	10 mm
397 129 70 9420	70 mm	10 mm
397 129 70 9430	75 mm	10 mm
397 129 70 9440	80 mm	10 mm
397 129 70 9450	85 mm	10 mm
397 129 70 9460	90 mm	10 mm
397 129 70 9470	95 mm	10 mm
397 129 70 9480	100 mm	10 mm
397 129 70 9490	105 mm	10 mm
397 129 70 9500	110 mm	10 mm
397 129 70 9510	115 mm	10 mm
397 129 70 9520	120 mm	10 mm
397 129 70 9530	125 mm	10 mm
397 129 70 9540	130 mm	10 mm

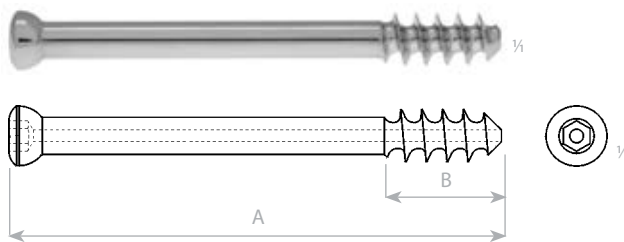

průměr závitu	thread diameter	7,0 mm
průměr dřívku	shank diameter	5,0 mm
průměr jádra	core diameter	3,5 mm
průměr hlavy	head diameter	8,0 mm
kanylovaný otvor	cannulation	1,8 mm
závitník	tap	HB 7
vrták pro závit	drill bit for threaded hole	Ø 4,0 mm
šroubovák	screwdriver	Ø 3,5 mm
drát vodící	guide wire	Ø 1,5 mm

SSt	A	B
397 129 79 8000	30 mm	16 mm
397 129 79 8010	35 mm	16 mm
397 129 79 8020	40 mm	16 mm
397 129 79 8030	45 mm	16 mm
397 129 79 8040	50 mm	16 mm
397 129 79 8050	55 mm	16 mm
397 129 79 8060	60 mm	16 mm
397 129 79 8070	65 mm	16 mm
397 129 79 8080	70 mm	16 mm
397 129 79 8090	75 mm	16 mm
397 129 79 8100	80 mm	16 mm
397 129 79 8110	85 mm	16 mm
397 129 79 8120	90 mm	16 mm
397 129 79 8130	95 mm	16 mm
397 129 79 8140	100 mm	16 mm
397 129 79 8150	105 mm	16 mm
397 129 79 8160	110 mm	16 mm
397 129 79 8170	115 mm	16 mm
397 129 79 8180	120 mm	16 mm
397 129 79 8190	125 mm	16 mm
397 129 79 8200	130 mm	16 mm

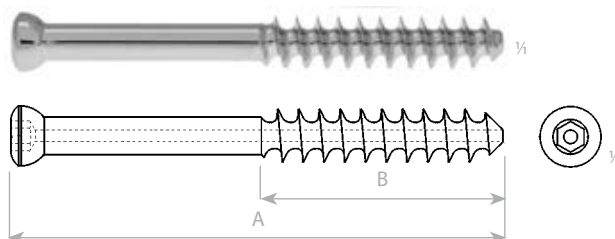

průměr závitu	thread diameter	7,0 mm
průměr dřívku	shank diameter	5,0 mm
průměr jádra	core diameter	3,5 mm
průměr hlavy	head diameter	8,0 mm
kanylovaný otvor	cannulation	1,8 mm
závitník	tap	HB 7
vrták pro závit	drill bit for threaded hole	Ø 4,0 mm
šroubovák	screwdriver	Ø 3,5 mm
drát vodící	guide wire	Ø 1,5 mm

SSt	A	B
397 129 79 8210	40 mm	32 mm
397 129 79 8220	45 mm	32 mm
397 129 79 8230	50 mm	32 mm
397 129 79 8240	55 mm	32 mm
397 129 79 8250	60 mm	32 mm
397 129 79 8260	65 mm	32 mm
397 129 79 8270	70 mm	32 mm
397 129 79 8280	75 mm	32 mm
397 129 79 8290	80 mm	32 mm
397 129 79 8300	85 mm	32 mm
397 129 79 8310	90 mm	32 mm
397 129 79 8320	95 mm	32 mm
397 129 79 8330	100 mm	32 mm
397 129 79 8340	105 mm	32 mm
397 129 79 8350	110 mm	32 mm
397 129 79 8360	115 mm	32 mm
397 129 79 8370	120 mm	32 mm
397 129 79 8380	125 mm	32 mm
397 129 79 8390	130 mm	32 mm

Podložka šroubů kostních
Bone screw washer



SSt	rozměr size	síla thickness
397 129 79 8400	6,5×13 mm	1,5 mm

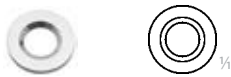

SSt	rozměr size	síla thickness
397 129 99 0838	4,6×8,8 mm	0,8 mm



SSt	rozměr size	síla thickness
397 129 99 0839	3,6×7 mm	0,7 mm

INSTRUMENTÁRIUM PRO ŠROUBY KOSTNÍ HA 2,7; HA 3,5; HB 4
 INSTRUMENTS FOR BONE SCREWS HA 2.7; HA 3.5; HB 4

397 139 09 0715 Set pro šrouby HA 2,7; HA 3,5; HB 4
 240 × 228 × 120 mm
síto s nástroji a stojánkem na šrouby,
bez implantátů

Set for screws HA 2.7; HA 3.5; HB 4
 240 × 228 × 120 mm
sieve including instruments and screws stand,
excluding implants

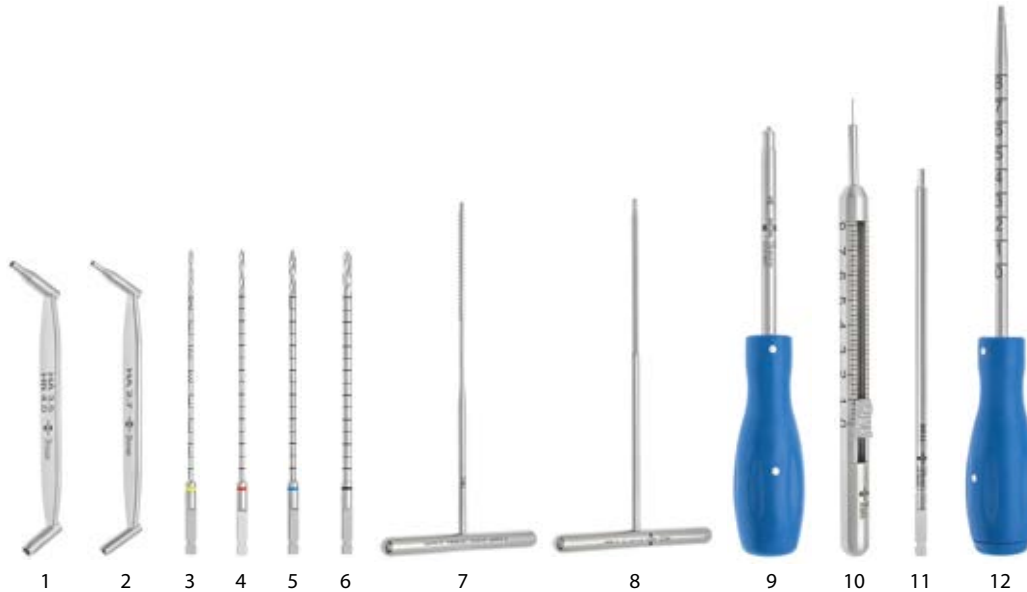

397 139 09 0710		soubor	set	ks/pcs
1	397 129 69 8750	Pouzdro HA 3,5 HB 4,0	Sleeve HA 3.5 and HB 4.0	1
2	397 129 69 8740	Pouzdro HA 2,7	Sleeve HA 2.7	1
3	397 129 69 8760	Vrták Ø 2,0×125 mm	Drill Ø 2.0×125 mm	1
4	397 129 69 8770	Vrták Ø 2,5×125 mm	Drill Ø 2.5×125 mm	1
5	397 129 69 8780	Vrták Ø 2,7×125 mm	Drill Ø 2.7×125 mm	1
6	397 129 69 8790	Vrták Ø 3,5×125 mm	Drill Ø 3.5×125 mm	1
7	397 129 79 8730	Závitník HB 4,0; 145 mm	Cancellous tap HB 4; 145 mm	1
8	397 129 79 8700	Závitník HA 3,5; 145 mm	Cortical tap HA 3.5; 145 mm	1
9	397 129 69 8730	Záhlubník 6 mm	Countersink 6 mm	1
10	397 129 69 7675	Hloubkoměr 80 mm	Depth gauge 80 mm	1
11	397 129 69 5231	Šroubovák 2,5×160 mm; šestihran	Screwdriver; hexagonal; 2.5×160 mm	1
12	397 129 69 5800	Šroubovák 2,5×232 mm; šestihran	Screwdriver; hexagonal; 2.5×232 mm	1



397 129 69 8800 Síto na nástroje pro HA 2,7; HA 3,5; HB 4
 240 × 217 × 50 mm
síto bez nástrojů a implantátů

Sieve for instruments for HA 2.7; HA 3.5; HB 4
 240 × 217 × 50 mm
sieve excluding instruments and implants



397 129 69 8810 Stojánek pro šrouby HA 2,7; HA 3,5; HB 4
 240 × 228 × 85 mm
bez implantátů

Stand for screws HA 2.7; HA 3.5; HB 4
 240 × 228 × 85 mm
excluding implants

Stojánek slouží pro uložení: šroubů HA 2,7 (8–40 mm; 17×8 ks); šroubů HA 3,5 (8–70 mm; 26×11 ks); šroubů HB 4/short (10–60 mm; 23×4 ks); šroubů HB 4/full (10–60 mm; 23×4 ks); podložek Ø 3,6 (40 ks); podložek Ø 4,4 (40 ks).
Stand is for keeping of: screws HA 2.7 (8–40 mm; 17×8 pcs); screws HA 3.5 (8–70 mm; 26×11 pcs); screws HB 4/short (10–60 mm; 23×4 pcs); screws HB 4/full (10–60 mm; 23×4 pcs); washers Ø 3.6 (40 pcs); washers Ø 4.4 (40 pcs).

INSTRUMENTÁRIUM PRO ŠROUBY KOSTNÍ HA 4,5; HB 6,5
INSTRUMENTS FOR BONE SCREWS HA 4.5; HB 6.5

397 139 09 0725 Set pro šrouby HA 4,5; HB 6,5
240 × 228 × 165 mm
síta s nástroji a stojánkem na šrouby,
bez implantátů

Set for screws HA 4.5; HB 6.5
240 × 228 × 165 mm
sieve including instruments and screws stand,
excluding implants

**397 139 09 0720**

soubor

set

1	397 129 69 8860	Pouzdro HA 4,5; HB 6,5
2	397 129 69 8870	Vrták Ø 3,2×180 mm
3	397 129 69 8880	Vrták Ø 4,5×180 mm
4	397 129 69 8900	Závitník HB 6,5; 210 mm
5	397 129 79 8690	Závitník HA 4,5; 185/70 mm
6	397 129 69 8850	Záhlubník 8 mm
7	397 129 69 8890	Hloubkoměr 120mm
8	397 129 69 5251	Šroubovák 3,5×160 mm; šestihran
9	397 129 69 8840	Šroubovák 3,5×215 mm; šestihran
10	397 129 69 4050	T-šroubovák 3,5×175 mm; šestihran

		Sleeve HA 4.5 and HB 6.5
		Drill Ø 3.2×180 mm
		Drill Ø 4.5×180 mm
		Cancellous tap HB 6.5; 210 mm
		Cortical tap HA 4.5; 185/70 mm
		Countersink 8 mm
		Depth gauge; 120 mm
		Screwdriver; hexagonal; 3.5×160 mm
		Screwdriver; hexagonal; 3.5×215 mm
		T-screwdriver; hexagonal; 3.5×175 mm

ks/pcs

1
1
1
1
1
1
1
1
1
1

397 129 69 8830 Síta na nástroje pro HA 4,5; HB 6,5
240 × 217 × 50 mm
síta bez nástrojů a implantátů

Sieve for instruments for HA 4.5; HB 6.5
240 × 217 × 50 mm
sieve excluding instruments and implants



397 129 69 8820 Stojánek pro šrouby HA 4,5; HB 6,5
240 × 228 × 130 mm
bez implantátů

Stand for screws HA 4.5; HB 6.5
240 × 228 × 130 mm
excluding implants

Stojánek slouží pro uložení: šroubů HA 4,5 (14–110 mm; 34×5 ks); šroubů HB 6,5/16 (25–120 mm; 20×4 ks); šroubů HB 6,5/32 (25–120 mm; 20×4 ks); podložek Ø 6 (40 ks).

Stand is for keeping of: screws HA 4.5 (14–110 mm; 34×5 pcs); screws HB 6.5/16 (25–120 mm; 20×4 pcs); screws HB 6.5/32 (25–120 mm; 20×4 pcs); washers Ø 6 (40 ks).

INSTRUMENTÁRIUM PRO ŠROUBY KOSTNÍ
 INSTRUMENTS FOR BONE SCREWS

397 129 79 8870 Stojánek na šrouby
 205 × 110 × 40 mm
 bez implantátů

Stand for screws
 205 × 110 × 40 mm
 excluding implants

Cortical HA 3,5 mm (8×): 8; 10; 12; 14; 16; 18; 20; 22; 24; 26
Cortical HA 2,7 mm (8×): 8; 10; 12; 14; 16; 18; 20; 22; 24
Cancelous HB 4 mm (5×): 10/5; 12/5; 14/5; 16/6; 18/7; 20/8; 22/9; 24/10; 26/12; 28/14; 30/14; 32/14



397 129 79 8860 Stojánek na šrouby
 230 × 145 × 80 mm
 bez implantátů

Stand for screws
 230 × 145 × 80 mm
 excluding implants

Cortical HA 4,5 mm (7×): 24; 26; 28; 30; 32; 34; 36; 38; 40; 42; 46; 48
Cancelous HB Ø 6,5 mm (4×): 25; 30; 35; 40; 45; 50; 55; 60 / 16 mm
Cancelous HB 6,5 mm (4×): 40; 45; 50; 55; 60; 65; 70; 75 / 32 mm
Maleolar HA 4,5 mm (3×): 25; 30; 35; 40; 45; 50; 55; 60; 65; 70



397 129 79 8890 Stojánek na šrouby navikulární
 110 × 85 × 55 mm
 bez implantátů

Stand for navicular screws
 110 × 85 × 55 mm
 excluding implants

Cortical HA 4,5 mm (5×): 10; 12; 14; 16; 18; 20; 22; 24; 26; 28; 30; 35; 40; 45; 50



397 129 79 8880 Stojánek na šrouby kanylované
 195 × 120 × 80 mm
 bez implantátů

Stand for cannulated screws
 195 × 120 × 80 mm
 excluding implants

Cortical HA 5 mm (5×): 25; 30; 35; 40; 45; 50; 55; 60; 65; 70
Cancelous HB 7 mm (5×): 30; 35; 40; 45; 50; 55; 60; 65 / 16 mm
Cancelous HB 7 mm (5×): 40; 45; 50; 55; 60; 65; 70; 75 / 32 mm

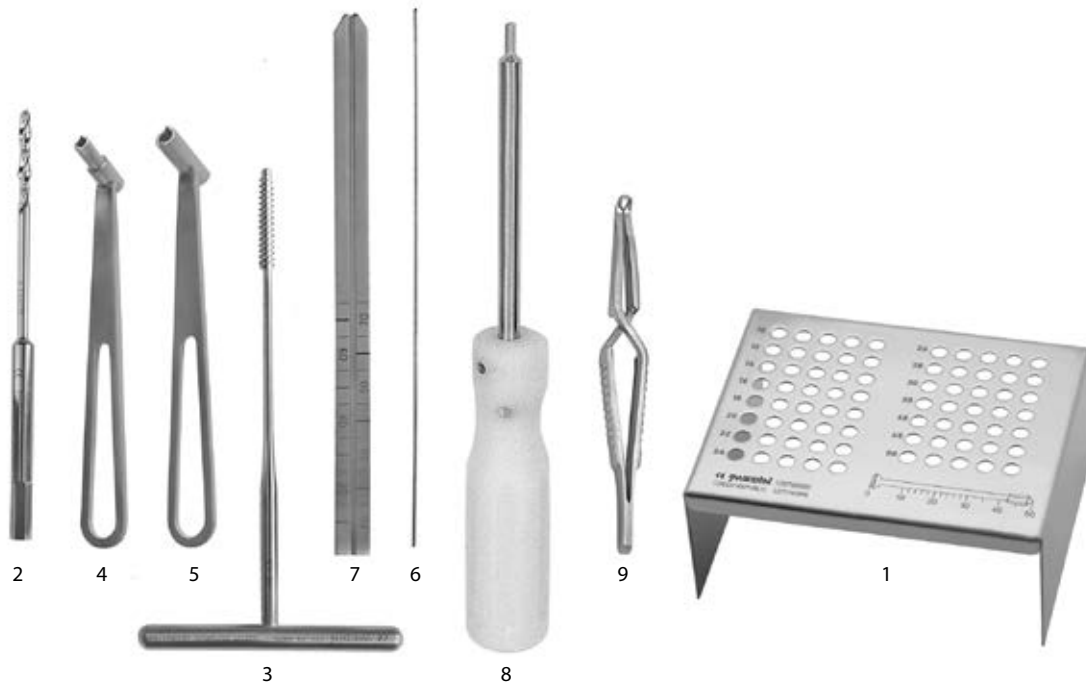
INSTRUMENTÁRIUM PRO ŠROUBY KOSTNÍ
INSTRUMENTS FOR BONE SCREWSInstrumentárium na zavedení šroubů kanylovaných – doporučený set malý
Instruments for insertion of cannulated screws – recommended set small

1	397 129 79 8890	Stojánek pro šrouby navikulární; 110×85×55 mm	Stand for navicular screws; 110×85×55 mm
2	397 129 79 8650	Vrták kanylovaný; 3,4/1,2×130 mm; koncovka šestihran	Cannulated drill; 3.4/1.2×130 mm; hexagonal connection
3	397 129 79 8800	Závítník kanylovaný HB 4,5/1,2×145 mm	Cannulated cancellous tap HB 4.5/1.2×145 mm
4	397 129 79 8970	Pouzdro vrtací; 3,7×20 mm	Drill sleeve; Ø 3.7 mm
5	397 129 79 8980	Pouzdro vrtací; 4,6×20 mm	Drill sleeve; Ø 4.6 mm
6	397 129 79 9030	Drát Kirschner se závitem; M1,0×160 mm	Kirschner wire with thread; 1.0×160 mm
7	397 129 79 9050	Měřidlo krátké; 160 mm	Rule short; 160 mm
8	397 129 79 8950	Šroubovák kanylovaný; šestihran 2,5/1,2 mm; 180 mm	Cannulated screwdriver; hexagonal 2.5/1.2 mm; 180 mm
9	397 114 08 0280	Pinzeta zkřížená pro kostní šrouby	Bone screw forceps

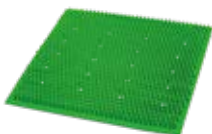
**B71/2**Koš perforovaný
240 × 240 × 70 mmPerforated basket
240 × 240 × 70 mm**B2000503L**Podložka silikonová
220 × 220 mmSilicone mat
220 × 220 mm

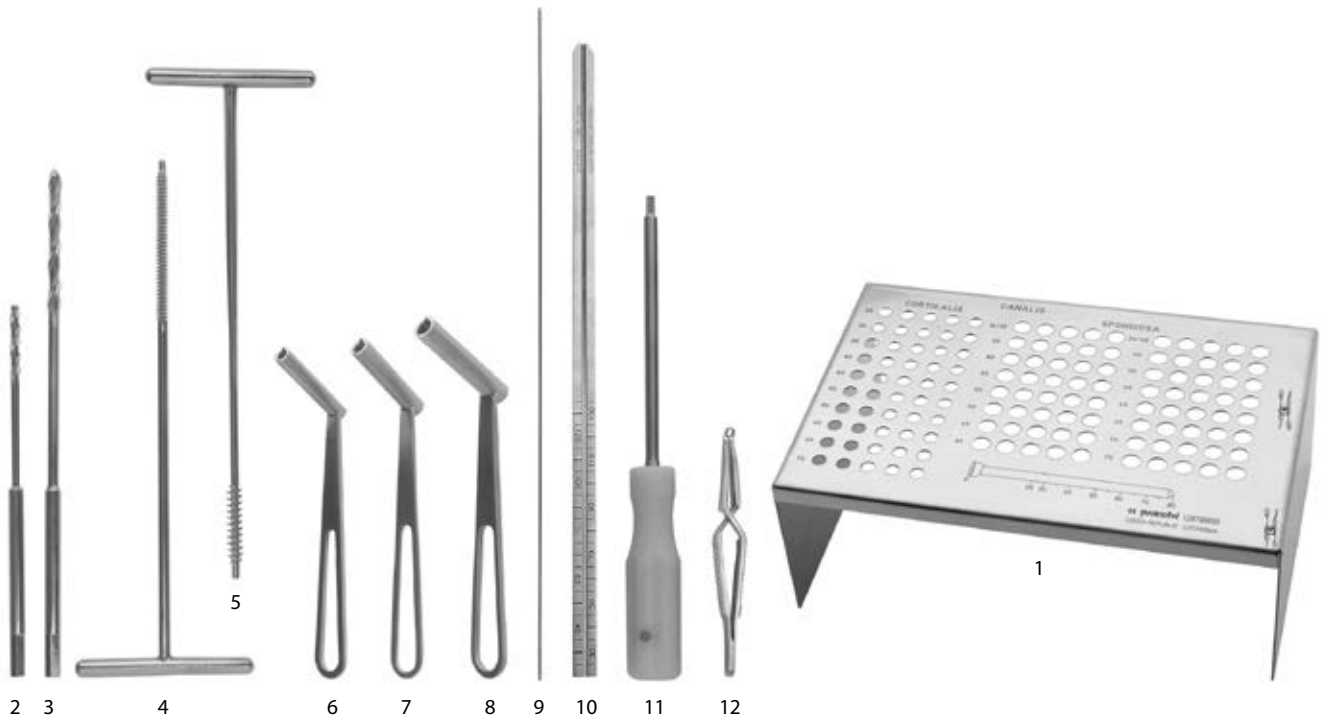

Instrumentárium na zavedení šroubů kanylových – doporučený set velký
Instruments for insertion of cannulated screws – recommended set large

1	397 129 79 8880	Stojánek na šrouby	Stand for screws
2	397 129 79 8640	Vrták kanylový; 4,0/1,8×160 mm	Cannulated drill; 4.0/1.8×160 mm
3	397 129 79 8630	Vrták kanylový; 5,0/1,8×220 mm	Cannulated drill; 5.0/1.8×220 mm
4	397 129 79 8790	Závitník kanylový HA 5,0/1,8×230 mm	Cannulated cortical tap HA 5.0/1.8×230 mm
5	397 129 79 8780	Závitník kanylový HB 7,0/1,8×230 mm	Cannulated cancellous tap HB 7.0/1.8×230 mm
6	397 129 79 8990	Pouzdro vrtací; 4,6×40 mm	Drill sleeve; 4.6×40 mm
7	397 129 79 9000	Pouzdro vrtací; 5,2×40 mm	Drill sleeve; 5.2×40 mm
8	397 129 79 9020	Chránič závitníku; 7,2×50 mm	Drill sleeve; 7.2×50 mm
9	397 129 79 9040	Drát Kirschner se závitěm; M1,6×300 mm	Kirschner wire with thread; 1.6×300 mm
10	397 129 79 9060	Měřidlo dlouhé; 280 mm	Rule long; 280 mm
11	397 129 79 8960	Šroubovák kanylový; šestihran 3,5/1,8 mm; 215 mm	Cannulated screwdriver; hexagonal 3.5/1.8 mm; 215 mm
12	397 114 08 0280	Pinzeta zkřížená pro kostní šrouby	Bone screw forceps

B73/2V

 Koš perforovaný
400 × 240 × 70 mm

 Perforated basket
400 × 240 × 70 mm

B2000508/2L

 Podložka silikonová
400 × 220 mm

 Silicone mat
400 × 220 mm

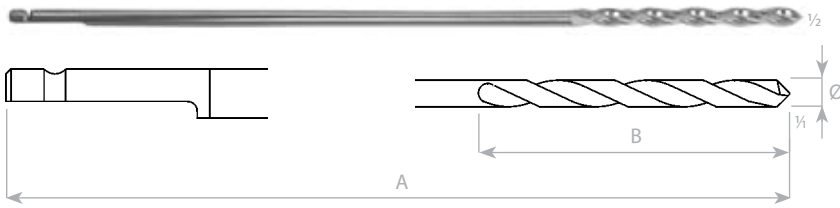

Vrták, koncovka s ploškou
Drill, flat connection

	A	B	Ø
397 129 79 8531	210 mm	60 mm	4,5 mm
397 129 79 8541	120 mm	60 mm	4,5 mm
397 129 79 8551	210 mm	60 mm	3,75 mm
397 129 79 8561	120 mm	60 mm	3,75 mm
397 129 79 8571	80 mm	30 mm	3,6 mm
397 129 79 8581	210 mm	60 mm	3,2 mm
397 129 79 8591	120 mm	60 mm	3,2 mm
397 129 79 8601	80 mm	30 mm	3,2 mm
397 129 79 9981	190 mm	50 mm	2,9 mm
397 129 79 8611	80 mm	30 mm	2,7 mm
397 129 79 8621	80 mm	30 mm	2,0 mm

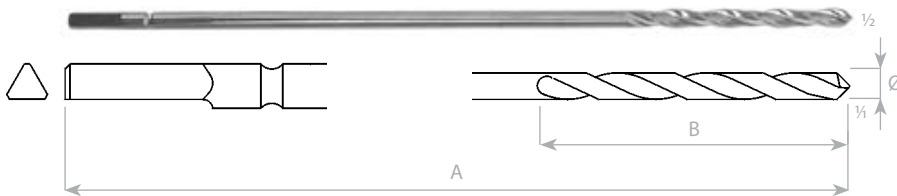

Vrták, koncovka tříhran
Drill, triangular connection

	A	B	Ø
397 129 79 8532	210 mm	60 mm	4,5 mm
397 129 79 8542	120 mm	60 mm	4,5 mm
397 129 79 8552	210 mm	60 mm	3,75 mm
397 129 79 8562	120 mm	60 mm	3,75 mm
397 129 79 8572	80 mm	30 mm	3,6 mm
397 129 79 8582	210 mm	60 mm	3,2 mm
397 129 79 8592	120 mm	60 mm	3,2 mm
397 129 79 8602	80 mm	30 mm	3,2 mm
397 129 79 9982	190 mm	50 mm	2,9 mm
397 129 79 8612	80 mm	30 mm	2,7 mm
397 129 79 8622	80 mm	30 mm	2,0 mm

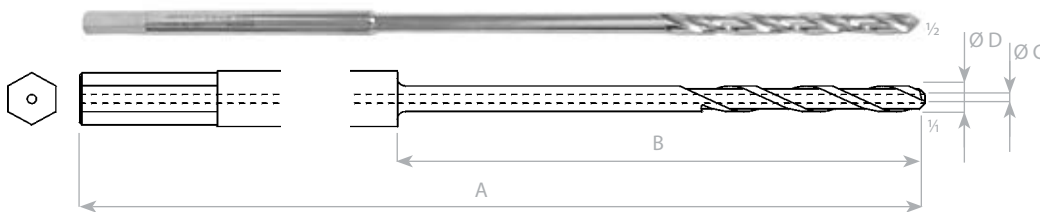

Vrták kanylovaný, koncovka šestihran
Cannulated drill, hexagonal connection

	A	B	Ø C	Ø D
397 129 79 8630	220 mm	140 mm	1,8 mm	5,0 mm
397 129 79 8640	160 mm	80 mm	1,8 mm	4,0 mm
397 129 79 8650	130 mm	70 mm	1,2 mm	3,4 mm

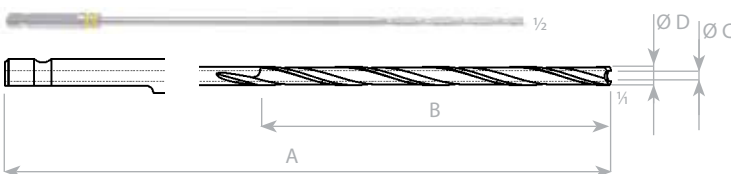

Vrták kanylovaný, koncovka s ploškou
Cannulated drill, flat connection

	A	B	Ø C	Ø D
397 129 69 7921	135 mm	45 mm	1,3 mm	2,4 mm

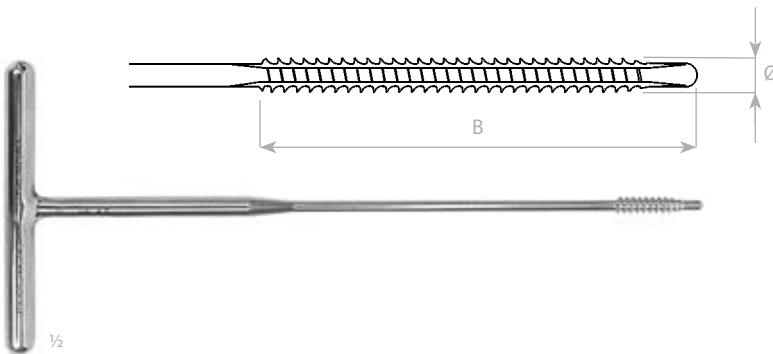
Závitník kortikální
 Cortical tap

		A	B	Ø
397 129 79 8680	HA 4,5	185 mm	25 mm	4,5 mm
397 129 79 8690	HA 4,5	185 mm	70 mm	4,5 mm
397 129 79 8700	HA 3,5	145 mm	65 mm	3,5 mm
397 129 79 8710	HA 2,7	140 mm	35 mm	2,7 mm

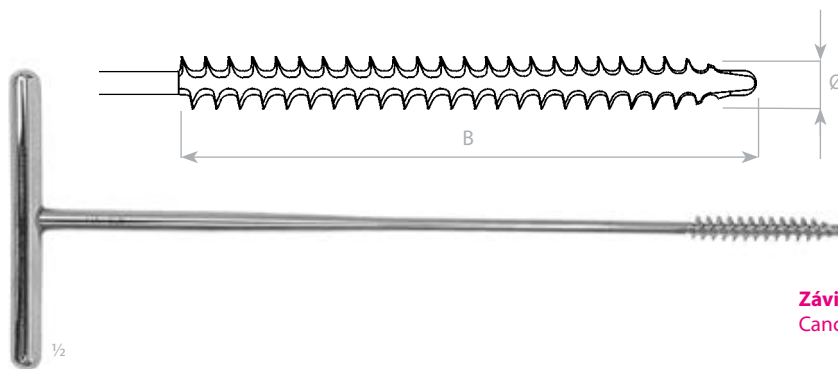
Závitník spongiozní
 Cancellous tap

		A	B	Ø
397 129 79 8720	HB 6,5	220 mm	40 mm	6,5 mm
397 129 79 8730	HB 4	145 mm	50 mm	4,0 mm

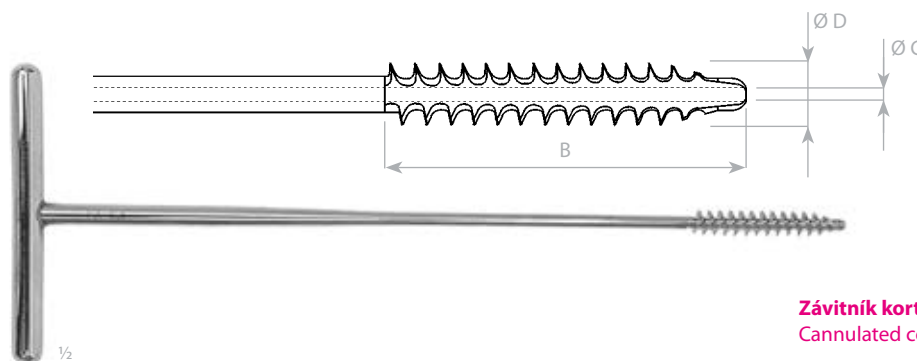
Závitník kortikální kanylovaný
 Cannulated cortical tap

		A	B	Ø C	Ø D
397 129 79 8790	HA 5	230 mm	70 mm	1,8 mm	5,0 mm

Závitník spongiozní kanylovaný
 Cannulated cancellous tap

		A	B	Ø C	Ø D
397 129 79 8780	HB 7	230 mm	40 mm	1,8 mm	7,0 mm
397 129 79 8800	HB 4,5	145 mm	30 mm	1,2 mm	4,5 mm

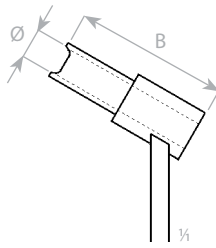

Pouzdro vrtací
Drill sleeve

	A	B	Ø
397 129 79 8970	98 mm	20 mm	3,7 mm

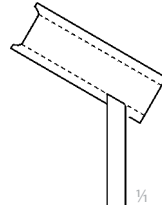

397 129 79 8980	98 mm	20 mm	4,6 mm
------------------------	-------	-------	--------

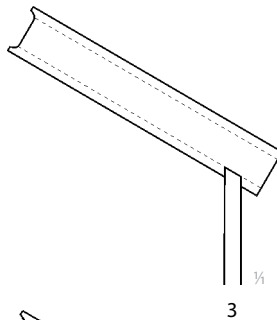

Pouzdro vrtací
Drill sleeve

	A	B	Ø
397 129 79 8990	98 mm	40 mm	4,6 mm

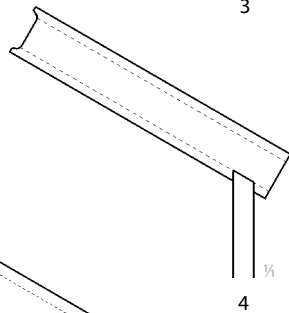

397 129 79 9000	98 mm	40 mm	5,2 mm
------------------------	-------	-------	--------

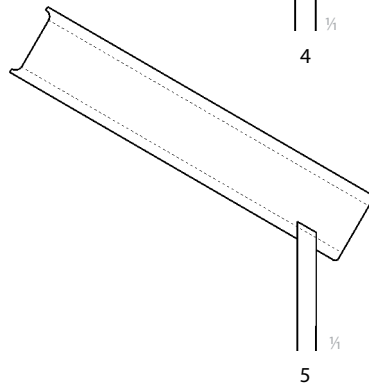

397 129 79 9020	111,5 mm	50 mm	7,2 mm
------------------------	----------	-------	--------



Šroubovák
Screwdriver

397 129 79 4340 ∅ 2,5 mm 214 mm



397 129 79 3900 ∅ 3,5 mm 215 mm



397 129 79 9990 křížový / cross 201 mm



Šroubovák kanylovaný
Cannulated screwdriver

397 129 79 8950 ∅ 2,5 / ∅ 1,2 mm 180 mm



397 129 79 8960 ∅ 3,5 / ∅ 1,8 mm 215 mm

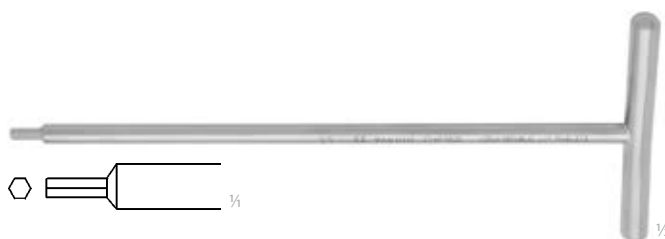

Šroubovák T
T-screwdriver

397 129 69 5020 ∅ 2,5 mm 175 mm

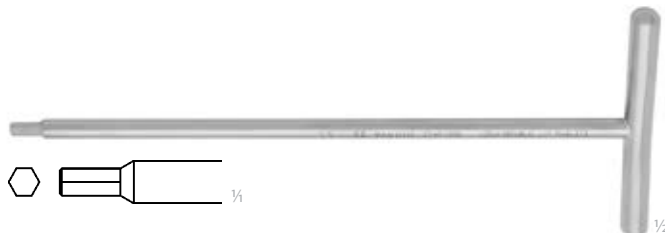

397 129 69 4050 ∅ 3,5 mm 175 mm

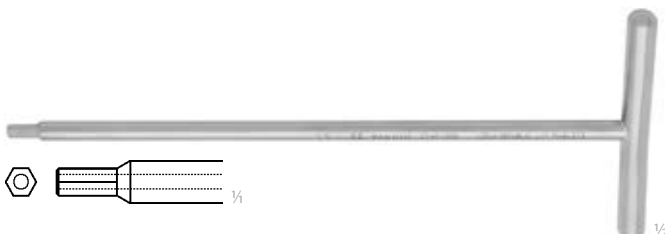

Šroubovák T kanylovaný
Cannulated T-screwdriver

397 129 69 4051 ∅ 3,5 / ∅ 1,8 mm 175 mm

INSTRUMENTÁRIUM PRO ŠROUBY KOSTNÍ
INSTRUMENTS FOR BONE SCREWSŠroubovák
Screwdriver

397 129 69 5231 Ø 2,5 mm 160 mm



397 129 69 5251 Ø 3,5 mm 160 mm

Šroubovák kanylovaný
Cannulated screwdriver

397 129 69 5261 Ø 3,5 / Ø 1,8 mm 160 mm

Držadlo AO
Handle AO

BD17-080-AO 120 mm



BD23-110-AO 151 mm



BD23-110-AO-0,8 0,8 Nm 168 mm



BD23-110-AO-1,5 1,5 Nm 168 mm



BD28-120-AO-4,0 4,0 Nm 171 mm

Držadlo AO; kanylované
Handle AO; canulated

BD17-080-AO-K20 Ø 2 mm 120 mm



BD23-110-AO-K20 Ø 2 mm 152 mm

INSTRUMENTÁRIUM PRO ŠROUBY KOSTNÍ
INSTRUMENTS FOR BONE SCREWS



Držadlo T AO
T-handle AO

BT19-095-AO

95×81 mm

½



Držadlo T AO
T-handle AO

BT23-116-AO-4Nm

4,0 Nm

116×129 mm

½



Pinzeta zkřížená pro kostní šrouby
Bone screw forceps

397 114 08 0280

107 mm

½

INSTRUMENTÁRIUM PRO ŠROUBY KOSTNÍ
INSTRUMENTS FOR BONE SCREWS

Hloubkoměr
Depth gauge
397 129 79 8900 HA 2,7; HA 3,5; HB 4 70 mm

397 129 79 8910 HA 4,5; HB 6,5 130 mm

397 129 69 7674 HA 2,7 30 mm

397 129 69 7670 HA 2,7 40 mm

397 129 69 7675 HA 2,7; HA 3,5; HB 4 80 mm

397 129 69 8890 HA 4,5; HB 6,5 120 mm

Drát Kirschner se závitem
Kirschner wire with thread
397 129 79 9030 1,0x160 mm

 balení 10 ks
 packing 10 pcs

397 129 79 9040 1,5x300 mm

 balení 10 ks
 packing 10 pcs

Měřidlo
Rule
397 129 79 9050 160 mm

 pro drát 129 79 9030
 for wire 129 79 9030

397 129 79 9060 280 mm

 pro drát 129 79 9040
 for wire 129 79 9040

INSTRUMENTÁRIUM NA EXTRAKCI ŠROUBŮ
 INSTRUMENTS FOR SCREWS EXTRACTION

397 139 09 0650 Set na extrakci šroubů
 540 × 240 × 50 mm
 včetně nástrojů

 Set for screw extraction
 540 × 240 × 50 mm
 including instruments

397 129 69 7795

soubor

set

ks/pcs

1	397 129 69 8260	Vrták 2,1×49 mm	Drill 2.1×49 mm	2
2	397 129 69 8270	Vrták 2,5×57 mm	Drill 2.5×57 mm	2
3	397 129 69 7740	Vrták 2,8×61 mm	Drill 2.8×61 mm	2
4	397 129 69 7750	Vrták 3,6×70 mm	Drill 3.6×70 mm	2
5	397 129 69 8290	Vrták 4,1×75 mm	Drill 4.1×75 mm	2
6	397 129 69 7770	Vrták 5,1×86 mm	Drill 5.1×86 mm	2
7	397 129 69 8220	Fréza válcová 2/2,4/2,7	Cylindrical cutter 2/2.4/2.7	1
8	397 129 79 4600	Fréza válcová 3,5/4	Cylindrical cutter 3.5/4	1
9	397 129 79 4610	Fréza válcová 4,5/5	Cylindrical cutter 4.5/5	1
10	397 129 79 4620	Fréza válcová 6,5/7	Cylindrical cutter 6.5/7	1
11	397 129 69 8230	Fréza 2/2,4/2,7	Cutter 2/2.4/2.7	1
12	397 129 79 4570	Fréza 3,5/4	Cutter 3.5/4	1
13	397 129 79 4580	Fréza 4,5/5	Cutter 4.5/5	1
14	397 129 79 4590	Fréza 6,5/7	Cutter 6.5/7	1
15	397 129 69 8210	Vytahovač 2/2,4/2,7	Extractor 2/2.4/2.7	1
16	397 129 79 4540	Vytahovač 3,5/4	Extractor 3.5/4	1
17	397 129 79 4550	Vytahovač 4,5/5	Extractor 4.5/5	1
18	397 129 79 4560	Vytahovač 6,5/7	Extractor 6.5/7	1

19	397 129 69 8181	Vytahovač 2	Extractor 2	2
20	397 129 69 7711	Vytahovač 2,5	Extractor 2.5	2
21	397 129 69 7721	Vytahovač 3,5	Extractor 3.5	2
22	397 129 69 7731	Vytahovač 5	Extractor 5	2
23	397 129 69 7910	Bit šestihran 2 mm	Bit, hexagon 2 mm	2
24	397 129 69 5231	Šroubovák šestihr. 2,5 mm	Screwdriver, hexagon 2.5 mm	2
25	397 129 69 5251	Šroubovák šestihr. 3,5 mm	Screwdriver, hexagon 3.5 mm	2
26	397 129 69 5273	Šroubovák šestihr. 5 mm	Screwdriver, hexagon 5 mm	2
27	397 128 09 0140	Dláto ortopedické žlábkové 6 mm; 23,5 cm	Orthopedic gouge 6 mm; 23.5 cm	1
28	397 148 51 0100	Exkavátor oboustranný	Excavator double-sided	1
29	397 129 69 7800	Vytahovač šroubů	Screw extractor	1
30	397 129 69 8350	Kleště na vyťahování šroubů	Forceps for removing screws	1
31	397 129 69 8360	Kleště na vyťahování šroubů 2/2,4/2,7 mm	Forceps for removing screws 2/2.4/2.7 mm	1
32	BD23-110-AO	Držadlo AO; 30×151 mm	Handle AO; 30×151 mm	1
33	BT19-095-AO	Držadlo T AO; 95×81 mm	T-handle AO; 95×81 mm	1

397 129 69 7790 Síto na instrumentárium na extrakci šroubů
 540 × 240 × 50 mm
 bez nástrojů

 Sieve for instruments for screw extraction
 540 × 240 × 50 mm
 excluding instruments

INSTRUMENTÁRIUM PRO ZAVÁDĚNÍ ŠROUBŮ HA 3,5 A HB 4 DO PÁNVE
INSTRUMENTS FOR HA 3.5 AND HB 4 SCREWS INSERTION INTO THE PELVIS

397 139 09 0770 Set pro zavádění šroubů do pánve
400 × 240 × 50 mm
včetně nástrojů

Set for screws insertion into the pelvis
400 × 240 × 50 mm
including instruments



1

2

3

4

5

397 129 69 9515

soubor

set

- | | | |
|---|------------------------|-------------------------------------|
| 1 | 397 129 69 9110 | Cílič pánevní |
| 2 | 397 129 69 9120 | Pouzdro Ø 6/2,7×218 mm |
| 3 | 397 129 69 9130 | Pouzdro Ø 6/1,5×218 mm |
| 4 | 397 129 69 9141 | Vrták Ø 2,7×320 mm |
| 5 | 397 129 69 9150 | Šroubovák; šestihran 2,5 mm; 301 mm |

- | | | |
|--|-------------------------------------|--------|
| | Pelvic guide device | ks/pcs |
| | Sleeve Ø 6/2.7×218 mm | 1 |
| | Sleeve Ø 6/1.5×218 mm | 2 |
| | Drill Ø 2.7×320 mm | 2 |
| | Screwdriver; hexagon 2.5 mm; 301 mm | 2 |
| | | 1 |

ks/pcs

1

2

2

2

1



397 129 69 9510 Síto na instrumentárium pro zavádění
šroubů do pánve
400 × 240 × 50 mm
bez nástrojů

Sieve for instruments for screws insertion
into the pelvis
400 × 240 × 50 mm
excluding instruments

DRÁTY A DROBNÉ IMPLANTÁTY **WIRES AND SMALL IMPLANTS**



B

DRÁTY A DROBNÉ IMPLANTÁTY WIRES AND SMALL IMPLANTS



Dráty

Dráty Kirschner

K-dráty

Instrumentárium pro dráty

Wires

Kirschner wires

K-wires

Instruments for wires

B.1

1

2

3

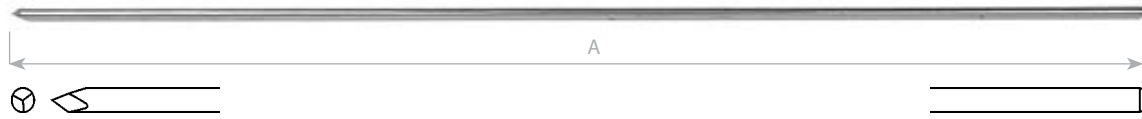
Drát Kirschner
Kirschner wire

SSt	A	Ø
397 129 09 2920	160 mm	0,8 mm
397 129 09 3140	160 mm	1,0 mm
397 129 09 3070	160 mm	1,2 mm
397 129 09 3080	160 mm	1,5 mm
397 129 09 3090	160 mm	1,8 mm
397 129 09 3100	160 mm	2,0 mm
397 129 09 3110	160 mm	2,5 mm
397 129 09 3120	160 mm	3,0 mm
397 129 09 2930	200 mm	0,8 mm
397 129 09 3130	200 mm	3,0 mm
397 129 09 2960	300 mm	0,8 mm
397 129 09 2970	300 mm	1,0 mm
397 129 09 2980	300 mm	1,2 mm
397 129 09 2990	300 mm	1,3 mm
397 129 09 3000	300 mm	1,5 mm
397 129 09 3010	300 mm	1,8 mm
397 129 09 3030	300 mm	2,0 mm
397 129 09 3040	300 mm	2,2 mm
397 129 09 3050	300 mm	2,5 mm
397 129 09 3060	300 mm	3,0 mm
397 129 09 3150	400 mm	4,0 mm

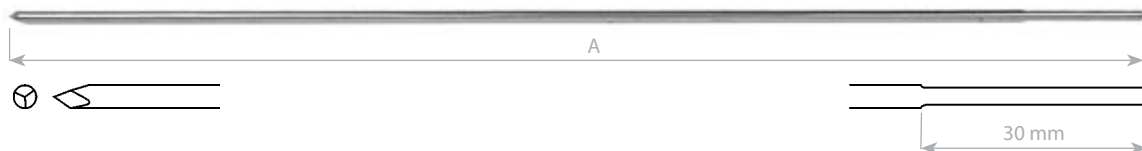
 balení 10 ks
packing 10 pcs

Drát Kirschner s ploškou
Kirschner wire with flat

SSt	A	Ø
397 129 09 3071	160 mm	1,2 mm
397 129 09 3081	160 mm	1,5 mm
397 129 09 3091	160 mm	1,8 mm
397 129 09 3101	160 mm	2,0 mm
397 129 09 3111	160 mm	2,5 mm
397 129 09 3121	160 mm	3,0 mm
397 129 09 3131	200 mm	3,0 mm
397 129 09 2981	300 mm	1,2 mm
397 129 09 3001	300 mm	1,5 mm
397 129 09 3011	300 mm	1,8 mm
397 129 09 3031	300 mm	2,0 mm
397 129 09 3041	300 mm	2,2 mm
397 129 09 3051	300 mm	2,5 mm
397 129 09 3061	300 mm	3,0 mm
397 129 09 3151	400 mm	4,0 mm

 balení 10 ks
packing 10 pcs

K-drát MEDIN
K-wire MEDIN

SSt	A	Ø
397 129 09 2470	160 mm	1,2 mm
397 129 09 2480	160 mm	1,5 mm
397 129 09 2490	160 mm	1,8 mm
397 129 09 2500	160 mm	2,0 mm
397 129 09 2510	160 mm	2,5 mm
397 129 09 2520	160 mm	3,0 mm
397 129 09 2530	200 mm	3,0 mm
397 129 09 2540	300 mm	1,2 mm
397 129 09 2550	300 mm	1,5 mm
397 129 09 2560	300 mm	1,8 mm
397 129 09 2570	300 mm	2,0 mm
397 129 09 2580	300 mm	2,2 mm
397 129 09 2590	300 mm	2,5 mm
397 129 09 2600	300 mm	3,0 mm
397 129 09 2610	400 mm	4,0 mm

balení 10 ks
 packing 10 pcs

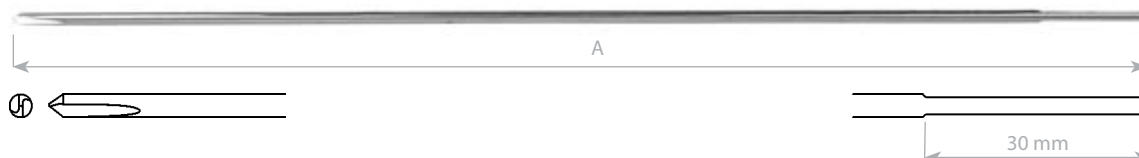
K-drát MEDIN s ploškou
K-wire MEDIN with shank

SSt	A	Ø
397 129 09 2471	160 mm	1,2 mm
397 129 09 2481	160 mm	1,5 mm
397 129 09 2491	160 mm	1,8 mm
397 129 09 2501	160 mm	2,0 mm
397 129 09 2511	160 mm	2,5 mm
397 129 09 2521	160 mm	3,0 mm
397 129 09 2531	200 mm	3,0 mm
397 129 09 2541	300 mm	1,2 mm
397 129 09 2551	300 mm	1,5 mm
397 129 09 2561	300 mm	1,8 mm
397 129 09 2571	300 mm	2,0 mm
397 129 09 2581	300 mm	2,2 mm
397 129 09 2591	300 mm	2,5 mm
397 129 09 2601	300 mm	3,0 mm

balení 10 ks
 packing 10 pcs

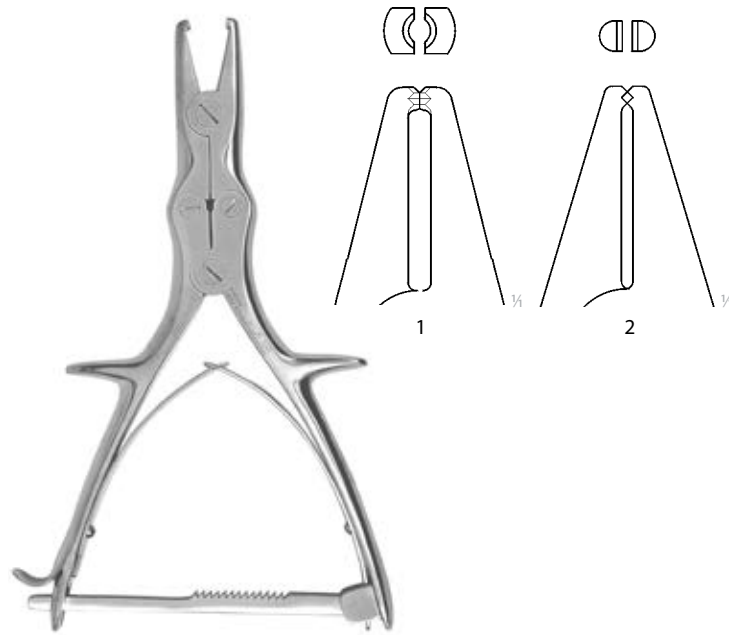

- 1 **397 117 09 0260** Bartl kleště na kostních prutů; 215 mm
na pruty od $\varnothing 2,0$ mm
- 2 **397 117 09 0270** Bartl kleště na kostních prutů; 215 mm
na pruty do $\varnothing 2,0$ mm

Bartl nail extraction forceps; 215 mm
for nails up from $\varnothing 2.0$ mm
Bartl nail extraction forceps; 215 mm
for nails up to $\varnothing 2.0$ mm

DLAHY ÚHLOVĚ STABILNÍ ANGULARLY STABLE PLATES



Dlahy úhlově stabilní se šrouby 2,7

Šrouby kostní uzamykatelné 2,7 a 2,4

Dlahy radiální distální volární

Instrumentárium pro dlahy radiální distální volární

Angularly stable plates with 2,7 screws

Locking kostní screws 2.7 and 2.4

Radial distal volar plates

Instruments for radial distal volar plates

C.1

1

2

3

Dlahy úhlově stabilní se šrouby 2,7 a 3,5

Šrouby kostní uzamykatelné 2,7

Šrouby kostní uzamykatelné 3,5

Dlahy humerální distální mediální úhlově stabilní

Dlahy humerální distální dorzolaterální úhlově stabilní

Instrumentárium pro dlahy úhlově stabilní se šrouby 2,7

Instrumentárium pro dlahy úhlově stabilní se šrouby 3,5

Angularly stable plates with 2.7 and 3.5 screws

Locking bone screws 2.7

Locking bone screws 3.5

Distal humeral medial plates angularly stable

Distal humeral dorsolateral plates angularly stable

Instruments for angularly stable plates with screws 2.7

Instruments for angularly stable plates with screws 3.5

C.2

1–2

3

4

5

6

7

Dlahy úhlově stabilní se šrouby 3,5

Šrouby kostní uzamykatelné 3,5

Dlahy humerální proximální úhlově stabilní

Dlahy humerální distální extraartikulární úhlově stabilní

Dlahy rekonstrukční úhlově stabilní

Dlahy tibiální distální mediální úhlově stabilní

Dlahy fibulární distální úhlově stabilní

Instrumentárium pro úhlově stabilní dlahy se šrouby 3,5

Dlahy žeberní

Instrumentárium pro dlahy žeberní

Angularly stable plates with 3.5 screws

Locking bone screws 3.5

Proximal humeral plates angularly stable

Distal humeral extra-articular plates angularly stable

Reconstruction plates angularly stable

Distal medial tibial plates angularly stable

Distal fibular plates angularly stable

Instruments for angularly stable plates with screws 3.5

Rib plates

Instruments for rib plates

C.3

1

2

3

4–5

6

7

8

9

10

Dlahy úhlově stabilní se šrouby 5

Šrouby kostní uzamykatelné 5

Dlahy tibiální proximální úhlově stabilní

Dlahy přímé úhlově stabilní

Dlahy femorální distální úhlově stabilní

Instrumentárium pro úhlově stabilní dlahy se šrouby 5

Instrumentárium pro dlahy femorální distální

Dlahy přímé úhlově stabilní

Dlahy femorální proximální úhlově stabilní

Implantáty pro periprotetické zlomeniny

Instrumentárium pro periprotetické poškození femuru

Angularly stable plates with screws 5

Locking bone screws 5

Proximal tibial plates angularly stable

Straight plates angularly stable

Distal femoral plates angularly stable

Instruments for angularly stable plates with screws 5

Instruments for distal femoral plates

Straight plates angularly stable

Proximal femoral plates angularly stable

Implants for periprosthetic fractures

Instrumentarium for periprosthetic femoral fractures

C.4

1–2

3

4

5

6

7

8

9

10

11–12

ŠROUBY KOSTNÍ ZAMYKATELNÉ 2,7 A 2,4
LOCKING BONE SCREWS 2.7 AND 2.4



průměr závitu	thread diameter	2,4 mm
průměr jádra	core diameter	1,7 mm
průměr hlavy	head diameter	3,5 mm
vrták pro závit	drill bit for threaded hole	Ø 1,8 mm
šroubovák	screwdriver	Ø 2,0 mm

Šroub uzamykatelný polyaxiální samořezný 2,4
Self-tapping locking polyaxial screw 2.4

Ti	A
397 129 70 1634	12 mm
397 129 70 1644	14 mm
397 129 70 1654	16 mm
397 129 70 1664	18 mm
397 129 70 1674	20 mm
397 129 70 1684	22 mm
397 129 70 1694	24 mm
397 129 70 1704	26 mm
397 129 70 1714	28 mm
397 129 70 1724	30 mm

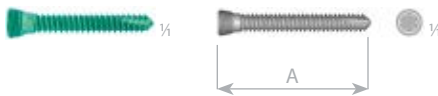

průměr závitu	thread diameter	2,4 mm
průměr jádra	core diameter	1,7 mm
průměr hlavy	head diameter	3,5 mm
vrták pro závit	drill bit for threaded hole	Ø 1,8 mm
šroubovák	screwdriver	Ø 2,0 mm

Šroub uzamykatelný samořezný 2,4
Self-tapping locking screw 2.4

Ti	A
397 129 70 1334	12 mm
397 129 70 1344	14 mm
397 129 70 1354	16 mm
397 129 70 1364	18 mm
397 129 70 1374	20 mm
397 129 70 1384	22 mm
397 129 70 1394	24 mm
397 129 70 1404	26 mm
397 129 70 1414	28 mm
397 129 70 1424	30 mm

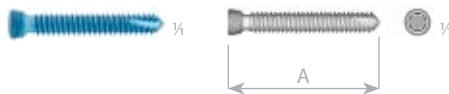

průměr závitu	thread diameter	2,7 mm
průměr jádra	core diameter	2,0 mm
průměr hlavy	head diameter	3,5 mm
vrták pro závit	drill bit for threaded hole	Ø 2,0 mm
šroubovák	screwdriver	Ø 2,0 mm

Šroub kortikální uzamykatelný samořezný 2,7
Self-tapping cortical locking screw 2.7

Ti	A
397 129 70 1934	12 mm
397 129 70 1944	14 mm
397 129 70 1954	16 mm
397 129 70 1964	18 mm
397 129 70 1974	20 mm
397 129 70 1984	22 mm
397 129 70 1994	24 mm
397 129 70 2004	26 mm
397 129 70 2014	28 mm
397 129 70 2024	30 mm

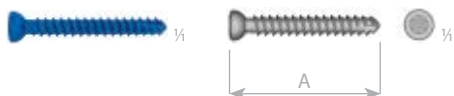

průměr závitu	thread diameter	2,7 mm
průměr jádra	core diameter	2,0 mm
průměr hlavy	head diameter	4,0 mm
vrták pro závit	drill bit for threaded hole	Ø 2,0 mm
šroubovák	screwdriver	Ø 2,0 mm

Šroub kortikální samořezný 2,7
Self-tapping cortical screw 2.7

Ti	A
397 129 70 2534	12 mm
397 129 70 2544	14 mm
397 129 70 2554	16 mm
397 129 70 2564	18 mm
397 129 70 2574	20 mm
397 129 70 2584	22 mm
397 129 70 2594	24 mm
397 129 70 2604	26 mm
397 129 70 2614	28 mm
397 129 70 2624	30 mm



397 129 68 0260 Stojánek na šrouby pro distální radius
135 × 90 × 36 mm
bez implantátů

Stand for radial distal volar screws
135 × 90 × 36 mm
excluding implants

DLAHY RADIÁLNÍ DISTÁLNÍ VOLÁRNÍ, 5. GENERACE
RADIAL DISTAL VOLAR PLATES, 5TH GENERATIONDlaha radiální distální volární úhlově stabilní, pravá
Radial distal volar plate angularly stable, right

Ti	A	počet otvorů holes (a × b)
397 129 70 4403	47 mm	6×2
397 129 70 4413	55 mm	6×3
397 129 70 4423	63 mm	6×4
397 129 70 4433	47 mm	7×2
397 129 70 4443	55 mm	7×3
397 129 70 4453	63 mm	7×4
397 129 70 4463	47 mm	8×2
397 129 70 4473	55 mm	8×3
397 129 70 4483	63 mm	8×4

Dlaha radiální distální volární úhlově stabilní, levá
Radial distal volar plate angularly stable, left

Ti	A	počet otvorů holes (a × b)
397 129 70 4303	47 mm	6×2
397 129 70 4313	55 mm	6×3
397 129 70 4323	63 mm	6×4
397 129 70 4333	47 mm	7×2
397 129 70 4343	55 mm	7×3
397 129 70 4353	63 mm	7×4
397 129 70 4363	47 mm	8×2
397 129 70 4373	55 mm	8×3
397 129 70 4383	63 mm	8×4

síla dlahy _____ plate thickness _____ 2,5 mm

ŠROUBY:

Šroub uzamykatelný samořezný 2,4
Šroub kortikální uzamykatelný samořezný 2,7
Šroub kortikální samořezný 2,7

SCREWS:

Self-tapping locking screw 2.4
Self-tapping cortical locking screw 2.7
Self-tapping cortical screw 2.7



397 129 68 0240 Síto na implantáty pro dlahy radiální distální volární
240 × 240 × 50 mm
bez implantátů

Sieve for implants for radial distal volar plates
240 × 240 × 50 mm
excluding implants

INSTRUMENTÁRIUM PRO DLAHY RADIÁLNÍ DISTÁLNÍ VOLÁRNÍ
INSTRUMENTS FOR RADIAL DISTAL VOLAR PLATES



397 139 09 0915 Set instrumentů pro dlahy radiální distální volární
240 × 240 × 90 mm
včetně nástrojů

Instruments for radial distal volar plates
240 × 240 × 90 mm
including instruments



397 139 09 0910		soubor	set	ks/pcs
1	397 129 09 2480	K-drát MEDIN; 1,5×160 mm	MEDIN K-wire; 1,5×160 mm	5
2	397 129 69 6700	Pouzdro vodicí uzamykatelné Ø 1,8 mm	Guide locking sleeve Ø 1.8 mm	2
3	397 129 69 6710	Pouzdro vodicí uzamykatelné Ø 2 mm	Guide locking sleeve Ø 2 mm	2
4	397 129 69 6720	Pouzdro vodicí uzamykatelné polyaxiální; 13×25 mm	Guide locking polyaxial sleeve; 13×25 mm	2
5	397 129 69 6730	Pouzdro vodicí Ø 2 mm	Guide sleeve Ø 2 mm	1
6	397 129 69 7400	Vrták Ø 1,8; 110 mm	Drill Ø 1.8; 110 mm	2
7	397 129 69 7410	Vrták Ø 2; 110 mm	Drill Ø 2; 110 mm	2
8	397 129 69 7674	Hloubkoměr	Depth gauge	1
9	397 129 69 7680	Páčidlo tupé	Elevator, blunt	1
10	397 129 69 7690	Háček tupý	Retractor, blunt	1
11	397 129 69 7910	Šroubovák šestihran; 2×90 mm	Screwdriver; hexagonal; 2×90 mm	1
12	397 129 69 8460	Páčidlo ostré	Elevator, sharp	1
13	BD17-080-AO	Držadlo AO; 21 × 120 mm	Holder AO; 21 × 120 mm	1



397 129 68 0230 Síto na instrumentárium pro dlahy radiální distální volární
240 × 240 × 90 mm
bez nástrojů

Sieve for instruments for radial distal volar plates
240 × 240 × 90 mm
excluding instruments

ŠROUBY KOSTNÍ UZAMYKATELNÉ 2,7

LOCKING BONE SCREWS 2.7

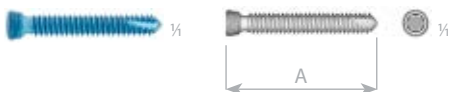

průměr závitu	thread diameter	2,7 mm
průměr jádra	core diameter	2,0 mm
průměr hlavy	head diameter	3,5 mm
vrták pro závit	drill bit for threaded hole	Ø 2,0 mm
šroubovák	screwdriver	Ø 2,0 mm

Šroub kortikální uzamykatelný samořezný 2,7
Self-tapping cortical locking screw 2.7

SSt	Ti	A
397 129 70 1901	397 129 70 1904	6 mm
397 129 70 1911	397 129 70 1914	8 mm
397 129 70 1921	397 129 70 1924	10 mm
397 129 70 1931	397 129 70 1934	12 mm
397 129 70 1941	397 129 70 1944	14 mm
397 129 70 1951	397 129 70 1954	16 mm
397 129 70 1961	397 129 70 1964	18 mm
397 129 70 1971	397 129 70 1974	20 mm
397 129 70 1981	397 129 70 1984	22 mm
397 129 70 1991	397 129 70 1994	24 mm
397 129 70 2001	397 129 70 2004	26 mm
397 129 70 2011	397 129 70 2014	28 mm
397 129 70 2021	397 129 70 2024	30 mm
397 129 70 2031	397 129 70 2034	32 mm
397 129 70 2041	397 129 70 2044	34 mm
397 129 70 2051	397 129 70 2054	36 mm
397 129 70 2061	397 129 70 2064	38 mm
397 129 70 2071	397 129 70 2074	40 mm
397 129 70 2081	397 129 70 2084	42 mm
397 129 70 2091	397 129 70 2094	44 mm
397 129 70 2101	397 129 70 2104	46 mm
397 129 70 2111	397 129 70 2114	48 mm
397 129 70 2121	397 129 70 2124	50 mm
397 129 70 2131	397 129 70 2134	55 mm
397 129 70 2141	397 129 70 2144	60 mm
397 129 70 2151	397 129 70 2154	65 mm
397 129 70 2161	397 129 70 2164	70 mm
397 129 70 2171	397 129 70 2174	75 mm
397 129 70 2181	397 129 70 2184	80 mm



průměr závitu	thread diameter	2,7 mm
průměr jádra	core diameter	1,6 mm
průměr hlavy	head diameter	3,5 mm
vrták pro závit	drill bit for threaded hole	Ø 1,8 mm
šroubovák	screwdriver	Ø 2,0 mm

Šroub spongiozní uzamykatelný samořezný 2,7
Self-tapping cancellous locking screw 2.7

SSt	Ti	A
397 129 70 2201	397 129 70 2204	6 mm
397 129 70 2211	397 129 70 2214	8 mm
397 129 70 2221	397 129 70 2224	10 mm
397 129 70 2231	397 129 70 2234	12 mm
397 129 70 2241	397 129 70 2244	14 mm
397 129 70 2251	397 129 70 2254	16 mm
397 129 70 2261	397 129 70 2264	18 mm
397 129 70 2271	397 129 70 2274	20 mm
397 129 70 2281	397 129 70 2284	22 mm
397 129 70 2291	397 129 70 2294	24 mm
397 129 70 2301	397 129 70 2304	26 mm
397 129 70 2311	397 129 70 2314	28 mm
397 129 70 2321	397 129 70 2324	30 mm
397 129 70 2331	397 129 70 2334	32 mm
397 129 70 2341	397 129 70 2344	34 mm
397 129 70 2351	397 129 70 2354	36 mm
397 129 70 2361	397 129 70 2364	38 mm
397 129 70 2371	397 129 70 2374	40 mm
397 129 70 2381	397 129 70 2384	42 mm
397 129 70 2391	397 129 70 2394	44 mm
397 129 70 2401	397 129 70 2404	46 mm
397 129 70 2411	397 129 70 2414	48 mm
397 129 70 2421	397 129 70 2424	50 mm
397 129 70 2431	397 129 70 2434	55 mm
397 129 70 2441	397 129 70 2444	60 mm
397 129 70 2451	397 129 70 2454	65 mm
397 129 70 2461	397 129 70 2464	70 mm
397 129 70 2471	397 129 70 2474	75 mm
397 129 70 2481	397 129 70 2484	80 mm

ŠROUBY KOSTNÍ UZAMYKATELNÉ 2,7
LOCKING BONE SCREWS 2.7

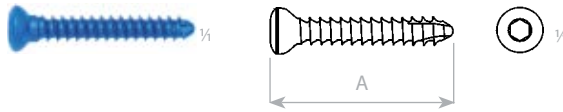

průměr závitu	thread diameter	3,5 mm
průměr jádra	core diameter	2,4 mm
průměr hlavy	head diameter	6,0 mm
vrták pro závit	drill bit for threaded hole	Ø 2,5 mm
vrták pro kluzný otvor	drill bit for gliding hole	Ø 3,5 mm
šroubovák	screwdriver	Ø 2,5 mm

Šroub kostní kortikální samořezný HA 3,5
Self-tapping cortical bone screw HA 3.5

SSt	Ti	A
397 129 79 5221	397 129 79 5224	12 mm
397 129 79 5231	397 129 79 5234	14 mm
397 129 79 5241	397 129 79 5244	16 mm
397 129 79 5251	397 129 79 5254	18 mm
397 129 79 5261	397 129 79 5264	20 mm
397 129 79 5271	397 129 79 5274	22 mm
397 129 79 5281	397 129 79 5284	24 mm
397 129 79 5291	397 129 79 5294	26 mm

ŠROUBY KOSTNÍ UZAMYKATELNÉ 3,5

LOCKING BONE SCREWS 3.5

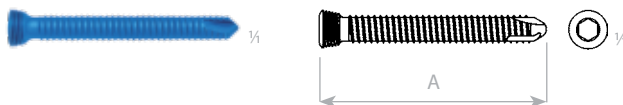

průměr závitů	thread diameter	3,5 mm
průměr jádra	core diameter	3,0 mm
průměr hlavy	head diameter	5,0 mm
vrták pro závit	drill bit for threaded hole	Ø 2,9 mm
šroubovák	screwdriver	Ø 2,5 mm

Šroub kostní uzamykatelný 3,5

Locking bone screw 3.5

SSt	Ti	A
397 129 77 7021	397 129 77 7024	8 mm
397 129 77 7031	397 129 77 7034	10 mm
397 129 77 7041	397 129 77 7044	12 mm
397 129 77 7051	397 129 77 7054	14 mm
397 129 77 7061	397 129 77 7064	16 mm
397 129 77 7071	397 129 77 7074	18 mm
397 129 77 7081	397 129 77 7084	20 mm
397 129 77 7091	397 129 77 7094	22 mm
397 129 77 7101	397 129 77 7104	24 mm
397 129 77 7111	397 129 77 7114	26 mm
397 129 77 7121	397 129 77 7124	28 mm
397 129 77 7131	397 129 77 7134	30 mm
397 129 77 7141	397 129 77 7144	32 mm
397 129 77 7151	397 129 77 7154	34 mm
397 129 77 7161	397 129 77 7164	36 mm
397 129 77 7171	397 129 77 7174	38 mm
397 129 77 7181	397 129 77 7184	40 mm
397 129 77 7191	397 129 77 7194	42 mm
397 129 77 7201	397 129 77 7204	44 mm
397 129 77 7211	397 129 77 7214	46 mm
397 129 77 7221	397 129 77 7224	48 mm
397 129 77 7231	397 129 77 7234	50 mm
397 129 77 7241	397 129 77 7244	55 mm
397 129 77 7251	397 129 77 7254	60 mm
397 129 77 7261	397 129 77 7264	65 mm
397 129 77 7271	397 129 77 7274	70 mm
397 129 77 7281	397 129 77 7284	75 mm

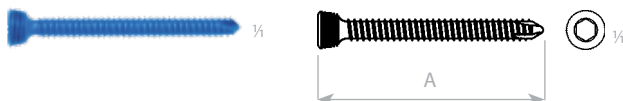

průměr závitů	thread diameter	2,7 mm
průměr jádra	core diameter	2,2 mm
průměr hlavy	head diameter	5,0 mm
vrták pro závit	drill bit for threaded hole	Ø 2,0 mm
šroubovák	screwdriver	Ø 2,5 mm

Šroub kostní uzamykatelný 3,5/2,7

Locking bone screw 3.5/2.7

SSt	Ti	A
397 129 77 7431	397 129 77 7434	10 mm
397 129 77 7441	397 129 77 7444	12 mm
397 129 77 7451	397 129 77 7454	14 mm
397 129 77 7461	397 129 77 7464	16 mm
397 129 77 7471	397 129 77 7474	18 mm
397 129 77 7481	397 129 77 7484	20 mm
397 129 77 7491	397 129 77 7494	22 mm
397 129 77 7501	397 129 77 7504	24 mm
397 129 77 7511	397 129 77 7514	26 mm
397 129 77 7521	397 129 77 7524	28 mm
397 129 77 7531	397 129 77 7534	30 mm
397 129 77 7541	397 129 77 7544	32 mm
397 129 77 7551	397 129 77 7554	34 mm
397 129 77 7561	397 129 77 7564	36 mm
397 129 77 7571	397 129 77 7574	38 mm
397 129 77 7921	397 129 77 7924	40 mm
397 129 77 7931	397 129 77 7934	42 mm
397 129 77 7941	397 129 77 7944	44 mm
397 129 77 7951	397 129 77 7954	46 mm
397 129 77 7961	397 129 77 7964	48 mm
397 129 77 7971	397 129 77 7974	50 mm



397 129 79 9960 Stojánek na šrouby uzamykatelné 3,5
225 × 161 × 86 mm
bez implantátů

Stand for locking screws 3.5
225 × 161 × 86 mm
excluding implants

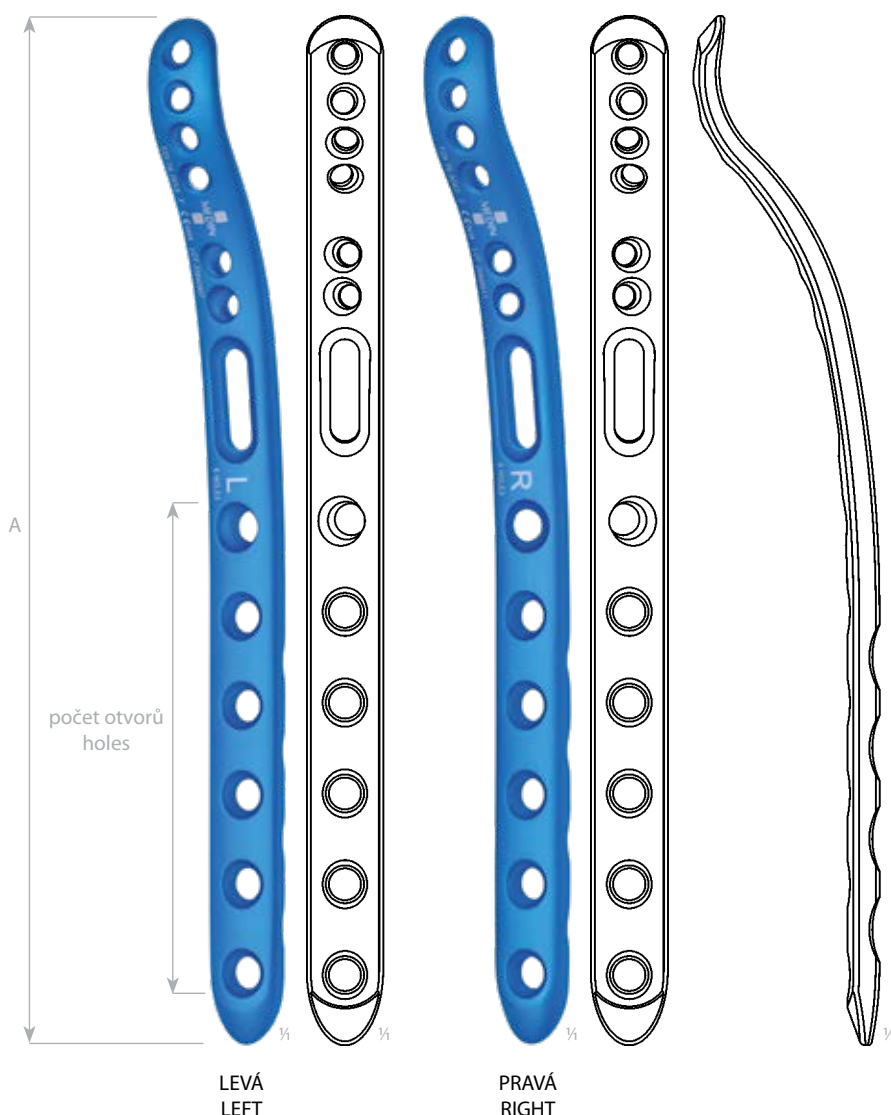
DLAHY HUMERÁLNÍ DISTÁLNÍ MEDIÁLNÍ ÚHLOVĚ STABILNÍ
DISTAL HUMERAL MEDIAL PLATES ANGULARLY STABLE

Dlaň humerální distální mediální, levá
 Distal humeral medial plate, left

SSt	Ti	A	počet otvorů holes
397 129 78 7870	397 129 78 7873	89 mm	2
397 129 78 7890	397 129 78 7893	113 mm	4
397 129 78 7910	397 129 78 7913	137 mm	6
397 129 78 7930	397 129 78 7933	161 mm	8
397 129 78 7950	397 129 78 7953	185 mm	10

 na zvláštní objednávku
 for special order

397 129 78 7850	397 129 78 7853	66 mm	0
397 129 78 7860	397 129 78 7863	77 mm	1
397 129 78 7880	397 129 78 7883	101 mm	3
397 129 78 7900	397 129 78 7903	125 mm	5
397 129 78 7920	397 129 78 7923	149 mm	7
397 129 78 7940	397 129 78 7943	173 mm	9
397 129 78 7960	397 129 78 7963	197 mm	11
397 129 78 7970	397 129 78 7973	209 mm	12

Dlaň humerální distální mediální, pravá
 Distal humeral medial plate, right

SSt	Ti	A	počet otvorů holes
397 129 78 8020	397 129 78 8023	89 mm	2
397 129 78 8040	397 129 78 8043	113 mm	4
397 129 78 8060	397 129 78 8063	137 mm	6
397 129 78 8080	397 129 78 8083	161 mm	8
397 129 78 8100	397 129 78 8103	185 mm	10

 na zvláštní objednávku
 for special order

397 129 78 8000	397 129 78 8003	66 mm	0
397 129 78 8010	397 129 78 8013	77 mm	1
397 129 78 8030	397 129 78 8033	101 mm	3
397 129 78 8050	397 129 78 8053	125 mm	5
397 129 78 8070	397 129 78 8073	149 mm	7
397 129 78 8090	397 129 78 8093	173 mm	9
397 129 78 8110	397 129 78 8113	197 mm	11
397 129 78 8120	397 129 78 8123	209 mm	12

síla dlahy plate thickness 3,2 mm

ŠROUBY:

 šrouby kostní uzamykatelné 3,5 a 3,5/2,7 mm
 šrouby kortikální uzamykatelné 2,7 mm
 šrouby spongiozní uzamykatelné 2,7 mm
 kortikální šrouby HA 3,5

SCREWS:

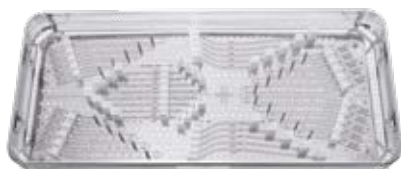
 locking bone screws 3.5 and 3.5/2.7 mm
 locking cortical screws 2.7 mm
 locking cancellous screws 2.7 mm
 cortical screws HA 3.5

397 129 69 8380

 Síto pro dlahy humerální distální a ulnární
 proximální
 540 × 240 × 50 mm
 bez implantátů

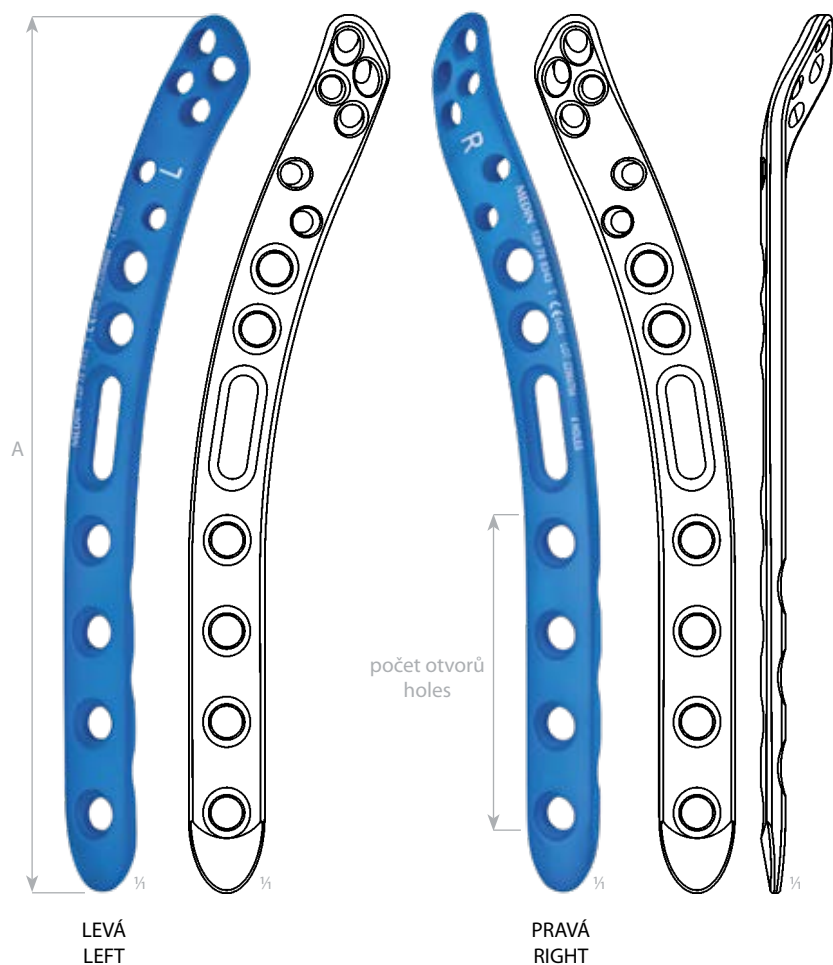
 Sieve for distal humeral and proximal ulnar
 plates
 540 × 240 × 50 mm
 excluding implants

DLAHY HUMERÁLNÍ DISTÁLNÍ DORZOLATERÁLNÍ ÚHLOVĚ STABILNÍ
DISTAL HUMERAL DORSOLATERAL PLATES ANGULARLY STABLE

Dlaha humerální distální dorzolaterální, levá
Distal humeral dorsolateral plate, left

SSt	Ti	A	počet otvorů holes
397 129 78 8170	397 129 78 8173	92 mm	2
397 129 78 8190	397 129 78 8193	116 mm	4
397 129 78 8210	397 129 78 8213	140 mm	6
397 129 78 8230	397 129 78 8233	164 mm	8
397 129 78 8250	397 129 78 8253	188 mm	10

na zvláštní objednávku
for special order

397 129 78 8150	397 129 78 8153	68 mm	0
397 129 78 8160	397 129 78 8163	80 mm	1
397 129 78 8180	397 129 78 8183	104 mm	3
397 129 78 8200	397 129 78 8203	128 mm	5
397 129 78 8220	397 129 78 8223	152 mm	7
397 129 78 8240	397 129 78 8243	176 mm	9
397 129 78 8260	397 129 78 8263	200 mm	11
397 129 78 8270	397 129 78 8273	212 mm	12

Dlaha humerální distální dorzolaterální, pravá
Distal humeral dorsolateral plate, right

SSt	Ti	A	počet otvorů holes
397 129 78 8320	397 129 78 8323	92 mm	2
397 129 78 8340	397 129 78 8343	116 mm	4
397 129 78 8360	397 129 78 8363	140 mm	6
397 129 78 8380	397 129 78 8383	164 mm	8
397 129 78 8400	397 129 78 8403	188 mm	10

na zvláštní objednávku
for special order

397 129 78 8300	397 129 78 8303	68 mm	0
397 129 78 8310	397 129 78 8313	80 mm	1
397 129 78 8330	397 129 78 8333	104 mm	3
397 129 78 8350	397 129 78 8353	128 mm	5
397 129 78 8370	397 129 78 8373	152 mm	7
397 129 78 8390	397 129 78 8393	176 mm	9
397 129 78 8410	397 129 78 8413	200 mm	11
397 129 78 8420	397 129 78 8423	212 mm	12

síla dlahy plate thickness 2,5 mm

ŠROUBY:

šrouby kostní uzamykatelné 3,5 a 3,5/2,7 mm
šrouby kortikální uzamykatelné 2,7 mm
šrouby spongiozní uzamykatelné 2,7 mm
kortikální šrouby HA 3,5

SCREWS:

locking bone screws 3.5 and 3.5/2.7 mm
locking cortical screws 2.7 mm
locking cancellous screws 2.7 mm
cortical screws HA 3.5

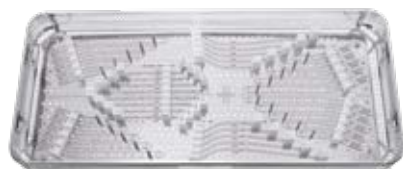

397 129 69 8380

Síto pro dlahy humerální distální a ulnární
proximální
540 × 240 × 50 mm
bez implantátů

Sieve for distal humeral and proximal ulnar
plates
540 × 240 × 50 mm
excluding implants

INSTRUMENTÁRIUM PRO ÚHLOVĚ STABILNÍ DLAHY SE ŠROUBY 2,7
INSTRUMENTS FOR ANGULARLY STABLE PLATES WITH SCREWS 2,7



397 139 09 0675 Instrumentárium pro USD se šrouby 2,7 mm
240 × 240 × 90 mm
včetně nástrojů

Instruments for ASP with screws 2.7 mm
240 × 240 × 90 mm
including instruments



1



2

3

4

5

6

7

8

9

10

397 139 09 0670

soubor

set

ks/pcs

- | | | |
|----|------------------------|---|
| 1 | 397 129 69 8320 | Stojánek na šrouby uzamykatelné 2,7 |
| 2 | 397 129 69 7675 | Hloubkoměr 80 mm |
| 3 | 397 129 69 7470 | Šroubovák šestihran; 2×140 mm |
| 4 | 397 129 69 7910 | Šroubovák šestihran; 2×90 mm |
| 5 | 397 129 69 8341 | Vrták Ø2,5×165 mm |
| 6 | 397 129 69 8110 | Vrták Ø2,0×165 mm |
| 7 | 397 129 69 8100 | Vrták Ø1,8×165 mm |
| 8 | 397 129 69 6710 | Pouzdro vodicí uzamykatelné 4/2×49 mm |
| 9 | 397 129 69 9800 | Pouzdro vodicí uzamykatelné 4/1.8×49 mm |
| 10 | 397 129 69 8330 | Pouzdro vodicí 2,5 mm |

- | | |
|---------------------------------------|---|
| Stand for locking screws 2.7 | 1 |
| Depth gauge 80 mm | 1 |
| Screwdriver hexagonal; 2×140 mm | 1 |
| Screwdriver shaft; hexagonal; 2×90 mm | 1 |
| Drill Ø2,5×165 mm | 1 |
| Drill Ø2,0×165 mm | 1 |
| Drill Ø1,8×165 mm | 1 |
| Guide sleeve locking 4/2×49 mm | 2 |
| Guide sleeve locking 4/1.8×49 mm | 2 |
| Guide sleeve 2.5 mm | 1 |



397 129 69 8370 Síto pro instrumentárium USD 2,7
240 × 240 × 90 mm
bez nástrojů

Sieve for instrumentarium ASP 2.7
240 × 240 × 90 mm
excluding instruments

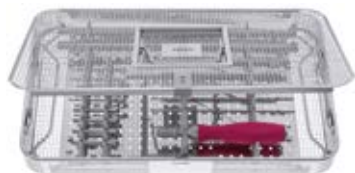
INSTRUMENTÁRIUM PRO ÚHLOVĚ STABILNÍ DLAHY SE ŠROUBY 3,5
INSTRUMENTS FOR ANGULARLY STABLE PLATES WITH SCREWS 3.5

397 139 09 0255 Instrumentárium pro USD se šrouby 3,5 mm
400 × 240 × 45 mm
včetně nástrojů

Instruments for ASP with screws 3.5 mm
400 × 240 × 45 mm
including instruments

**397 139 09 0250**

soubor

set

			ks/pcs
1	397 129 09 2550	K-drát MEDIN 1,5×300 mm	3
2	397 129 09 2570	K-drát MEDIN; 2×300 mm	3
3	B76.16.05	Toulec sterilizační 320 mm	2
4	397 129 69 3360	Pouzdro vodicí uzamykatelné 2,9×60 mm	4
5	397 129 69 3370	Pouzdro vodicí 2,9/1,6×75 mm	2
6	397 129 69 4360	Pouzdro vodicí 2,9/2×75 mm	2
7	397 129 69 7675	Hloubkoměr 80 mm	1
8	BD23-110-AO-1,5	Držadlo AO; 1,5 Nm; 30×168 mm	1
9	397 129 69 5231	Šroubovák; šestihran 2,5×160 mm	2
10	397 129 79 9981	Vrták Ø2,9×190 mm	2

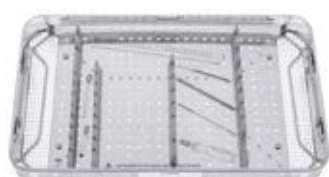

397 129 69 4390 Síto pro instrumentárium USD 3,5
400 × 240 × 45 mm
bez nástrojů

Sieve for instrumentarium ASP 3.5
400 × 240 × 45 mm
excluding instruments

ŠROUBY KOSTNÍ UZAMYKATELNÉ 3,5
LOCKING BONE SCREWS 3.5

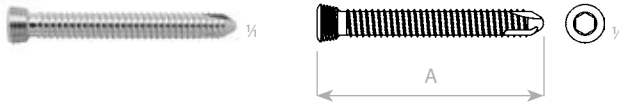

průměr závitů	thread diameter	3,5 mm
průměr jádra	core diameter	3,0 mm
průměr hlavy	head diameter	5,0 mm
vrták pro závit	drill bit for threaded hole	Ø 2,9 mm
šroubovák	screwdriver	Ø 2,5 mm

Šroub kostní uzamykatelný 3,5
Locking bone screw 3.5

SSt	Ti	A
397 129 77 7021	397 129 77 7024	8 mm
397 129 77 7031	397 129 77 7034	10 mm
397 129 77 7041	397 129 77 7044	12 mm
397 129 77 7051	397 129 77 7054	14 mm
397 129 77 7061	397 129 77 7064	16 mm
397 129 77 7071	397 129 77 7074	18 mm
397 129 77 7081	397 129 77 7084	20 mm
397 129 77 7091	397 129 77 7094	22 mm
397 129 77 7101	397 129 77 7104	24 mm
397 129 77 7111	397 129 77 7114	26 mm
397 129 77 7121	397 129 77 7124	28 mm
397 129 77 7131	397 129 77 7134	30 mm
397 129 77 7141	397 129 77 7144	32 mm
397 129 77 7151	397 129 77 7154	34 mm
397 129 77 7161	397 129 77 7164	36 mm
397 129 77 7171	397 129 77 7174	38 mm
397 129 77 7181	397 129 77 7184	40 mm
397 129 77 7191	397 129 77 7194	42 mm
397 129 77 7201	397 129 77 7204	44 mm
397 129 77 7211	397 129 77 7214	46 mm
397 129 77 7221	397 129 77 7224	48 mm
397 129 77 7231	397 129 77 7234	50 mm
397 129 77 7241	397 129 77 7244	55 mm
397 129 77 7251	397 129 77 7254	60 mm
397 129 77 7261	397 129 77 7264	65 mm
397 129 77 7271	397 129 77 7274	70 mm
397 129 77 7281	397 129 77 7284	75 mm

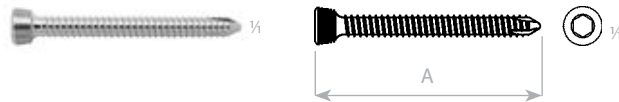

průměr závitů	thread diameter	2,7 mm
průměr jádra	core diameter	2,2 mm
průměr hlavy	head diameter	5,0 mm
vrták pro závit	drill bit for threaded hole	Ø 2,0 mm
šroubovák	screwdriver	Ø 2,5 mm

Šroub kostní uzamykatelný 3,5/2,7
Locking bone screw 3.5/2.7

SSt	Ti	A
397 129 77 7431	397 129 77 7434	10 mm
397 129 77 7441	397 129 77 7444	12 mm
397 129 77 7451	397 129 77 7454	14 mm
397 129 77 7461	397 129 77 7464	16 mm
397 129 77 7471	397 129 77 7474	18 mm
397 129 77 7481	397 129 77 7484	20 mm
397 129 77 7491	397 129 77 7494	22 mm
397 129 77 7501	397 129 77 7504	24 mm
397 129 77 7511	397 129 77 7514	26 mm
397 129 77 7521	397 129 77 7524	28 mm
397 129 77 7531	397 129 77 7534	30 mm
397 129 77 7541	397 129 77 7544	32 mm
397 129 77 7551	397 129 77 7554	34 mm
397 129 77 7561	397 129 77 7564	36 mm
397 129 77 7571	397 129 77 7574	38 mm
397 129 77 7921	397 129 77 7924	40 mm
397 129 77 7931	397 129 77 7934	42 mm
397 129 77 7941	397 129 77 7944	44 mm
397 129 77 7951	397 129 77 7954	46 mm
397 129 77 7961	397 129 77 7964	48 mm
397 129 77 7971	397 129 77 7974	50 mm



397 129 79 9960 Stojánek na šrouby uzamykatelné 3,5
225 × 161 × 86 mm
bez implantátů

Stand for locking screws 3.5
225 × 161 × 86 mm
excluding implants

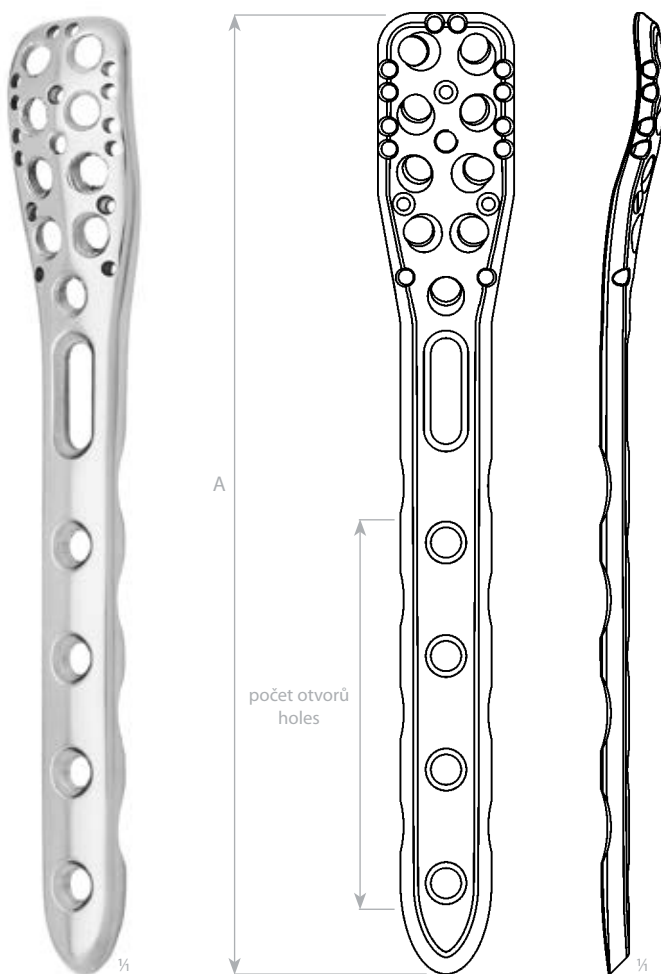
DLAHY HUMERÁLNÍ PROXIMÁLNÍ ÚHLOVĚ STABILNÍ
PROXIMAL HUMERAL PLATES ANGULARLY STABLE

Dlaha humerální proximální úhlově stabilní
Proximal humeral plate angularly stable

SSt	Ti	A	počet otvorů holes
397 129 78 3500	397 129 78 3503	97 mm	2
397 129 78 3520	397 129 78 3523	127 mm	4
397 129 78 3540	397 129 78 3543	157 mm	6
397 129 78 3560	397 129 78 3563	187 mm	8

na zvláštní objednávku – for special order

397 129 78 3510	397 129 78 3513	112 mm	3
397 129 78 3530	397 129 78 3533	142 mm	5
397 129 78 3550	397 129 78 3553	172 mm	7

síla dlahy _____ plate thickness _____ 2,7 mm

ŠROUBY:

 šrouby kostní uzamykatelné 3,5 a 3,5/2,7 mm
 kortikální šrouby HA 3,5

SCREWS:

 locking bone screws 3.5 and 3.5/2.7 mm
 cortical screws HA 3.5

397 129 69 6070 Síto pro dlahy humerální proximální
 240 × 240 × 50 mm
 bez implantátů a nástrojů

 Sieve for proximal humeral plates
 240 × 240 × 50 mm
 excluding implants and instruments

Doplňkové nástroje
Supplementary instruments

397 129 77 9200
397 129 69 4590

 Cílicí blok
 Pouzdro Ø5,9/5,1 mm; 40 mm

 Aiming device
 Sleeve Ø5.9/5.1 mm; 40 mm

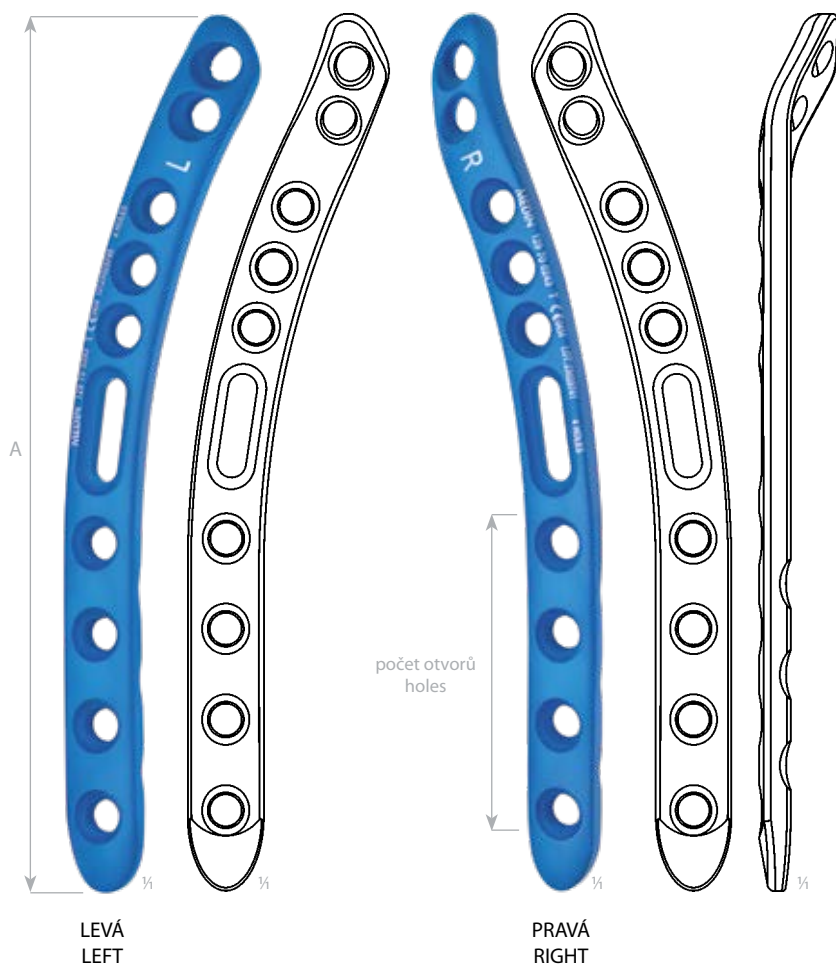
DLAHY HUMERÁLNÍ DISTÁLNÍ EXTRAARTIKULÁRNÍ ÚHLOVĚ STABILNÍ
DISTAL HUMERAL EXTRA-ARTICULAR PLATES ANGULARLY STABLE

Dlaha humerální distální extraartikulární, levá
 Distal humeral extra-articular plate, left

SSt	Ti	A	počet otvorů holes
397 129 70 0370	397 129 70 0373	92 mm	2
397 129 70 0390	397 129 70 0393	116 mm	4
397 129 70 0410	397 129 70 0413	140 mm	6
397 129 70 0430	397 129 70 0433	164 mm	8
397 129 70 0450	397 129 70 0453	188 mm	10

 na zvláštní objednávku
 for special order

397 129 70 0350	397 129 70 0353	68 mm	0
397 129 70 0360	397 129 70 0363	80 mm	1
397 129 70 0380	397 129 70 0383	104 mm	3
397 129 70 0400	397 129 70 0403	128 mm	5
397 129 70 0420	397 129 70 0423	152 mm	7
397 129 70 0440	397 129 70 0443	176 mm	9
397 129 70 0460	397 129 70 0463	200 mm	11
397 129 70 0470	397 129 70 0473	212 mm	12

Dlaha humerální distální extraartikulární, pravá
 Distal humeral extra-articular plate, right

SSt	Ti	A	počet otvorů holes
397 129 70 0220	397 129 70 0223	92 mm	2
397 129 70 0240	397 129 70 0243	116 mm	4
397 129 70 0260	397 129 70 0263	140 mm	6
397 129 70 0280	397 129 70 0283	164 mm	8
397 129 70 0300	397 129 70 0303	188 mm	10

 na zvláštní objednávku
 for special order

397 129 70 0200	397 129 70 0203	68 mm	0
397 129 70 0210	397 129 70 0213	80 mm	1
397 129 70 0230	397 129 70 0233	104 mm	3
397 129 70 0250	397 129 70 0253	128 mm	5
397 129 70 0270	397 129 70 0273	152 mm	7
397 129 70 0290	397 129 70 0293	176 mm	9
397 129 70 0310	397 129 70 0313	200 mm	11
397 129 70 0320	397 129 70 0323	212 mm	12

síla dlahy plate thickness 3,5 mm

ŠROUBY:
 šrouby kostní uzamykatelné 3,5 a 3,5/2,7 mm
 kortikální šrouby HA 3,5

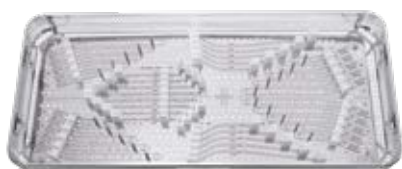
SCREWS:
 locking bone screws 3.5 and 3.5/2.7 mm
 cortical screws HA 3.5

397 129 69 8380 Síto pro dlahy humerální distální a ulnární proximální
 540 × 240 × 50 mm
 bez implantátů

Sieve for distal humeral and proximal ulnar plates
 540 × 240 × 50 mm
 excluding implants

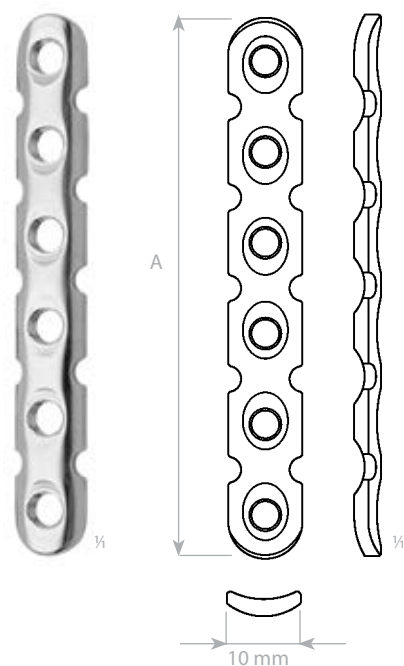
DLAHY REKONSTRUKČNÍ ÚHLOVĚ STABILNÍ
RECONSTRUCTION PLATES ANGULARLY STABLE

Dlaha rekonstrukční úhlově stabilní
Reconstruction plate angularly stable

SSt	Ti	A	počet otvorů holes
397 129 77 7330	397 129 77 7333	48 mm	4
397 129 77 7340	397 129 77 7343	60 mm	5
397 129 77 7350	397 129 77 7353	72 mm	6
397 129 77 7360	397 129 77 7363	84 mm	7
397 129 77 7370	397 129 77 7373	96 mm	8
397 129 77 7380	397 129 77 7383	108 mm	9
397 129 77 7390	397 129 77 7393	120 mm	10
397 129 77 7400	397 129 77 7403	132 mm	11
397 129 77 7410	397 129 77 7413	144 mm	12

síla dlahy	plate thickness	2,2 mm
vzdálenost otvorů	distance of holes	12 mm

ŠROUBY:

šrouby kostní uzamykatelné 3,5 a 3,5/2,7 mm
kortikální šrouby HA 3,5

SCREWS:

locking bone screws 3.5 and 3.5/2.7 mm
cortical screws HA 3.5

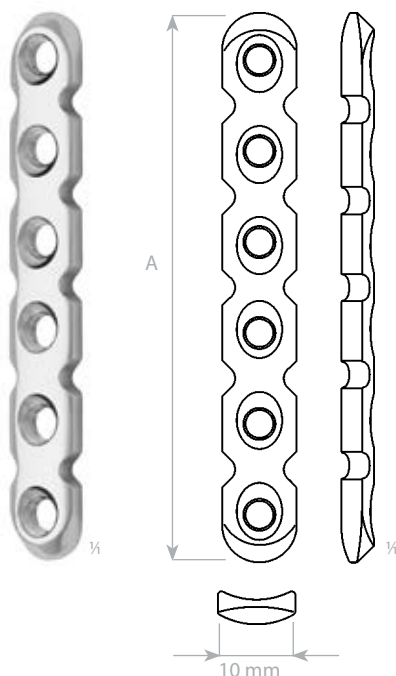
Dlaha rekonstrukční silná úhlově stabilní
Reconstruction plate thick angularly stable

SSt	Ti	A	počet otvorů holes
397 129 77 7810	397 129 77 7813	48 mm	4
397 129 77 7820	397 129 77 7823	60 mm	5
397 129 77 7830	397 129 77 7833	72 mm	6
397 129 77 7840	397 129 77 7843	84 mm	7
397 129 77 7850	397 129 77 7853	96 mm	8
397 129 77 7860	397 129 77 7863	108 mm	9
397 129 77 7870	397 129 77 7873	120 mm	10
397 129 77 7880	397 129 77 7883	132 mm	11
397 129 77 7890	397 129 77 7893	144 mm	12

síla dlahy	plate thickness	3,0 mm
vzdálenost otvorů	distance of holes	12 mm

ŠROUBY:

šrouby kostní uzamykatelné 3,5 a 3,5/2,7 mm
kortikální šrouby HA 3,5

SCREWS:

locking bone screws 3.5 and 3.5/2.7 mm
cortical screws HA 3.5

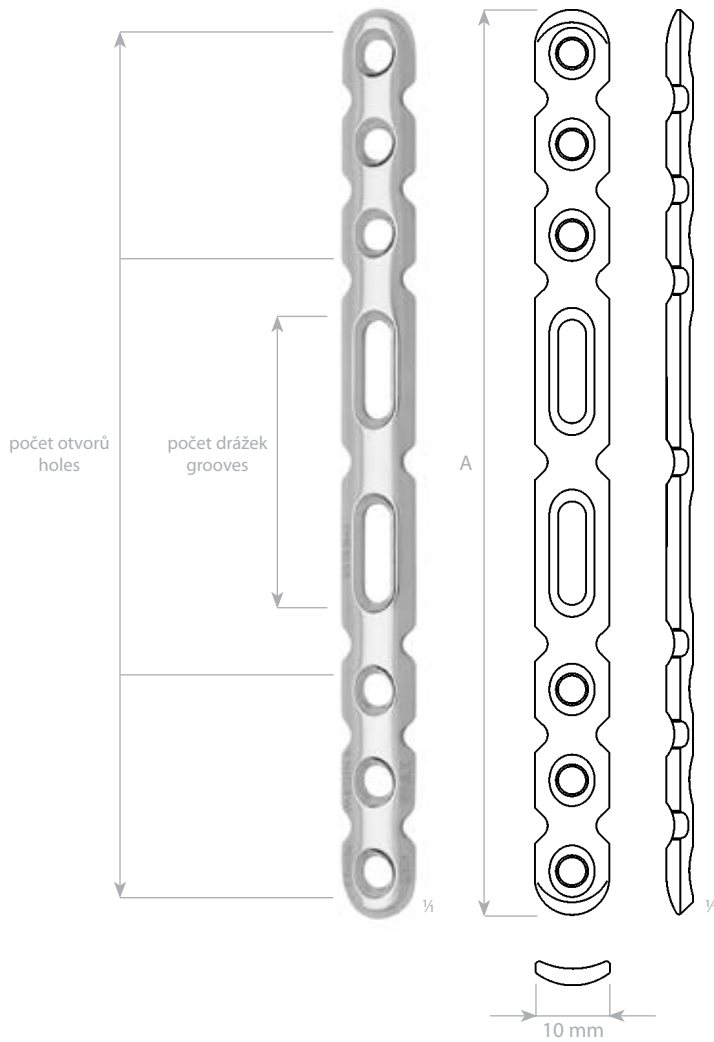

Dlaha rekonstrukční úhlově stabilní
Reconstruction plate angularly stable

SSt	A	počet otvorů holes	počet drážek grooves
397 129 78 3630	96 mm	4	2
397 129 78 3640	120 mm	6	2
397 129 78 3650	144 mm	6	3
397 129 78 3660	168 mm	6	4

síla dlahy	plate thickness	2,4 mm
vzdálenost otvorů	distance of holes	12 mm

ŠROUBY:
šrouby kostní uzamykatelné 3,5 a 3,5/2,7 mm
kortikální šrouby HA 3,5

SCREWS:
locking bone screws 3.5 and 3.5/2.7 mm
cortical screws HA 3.5

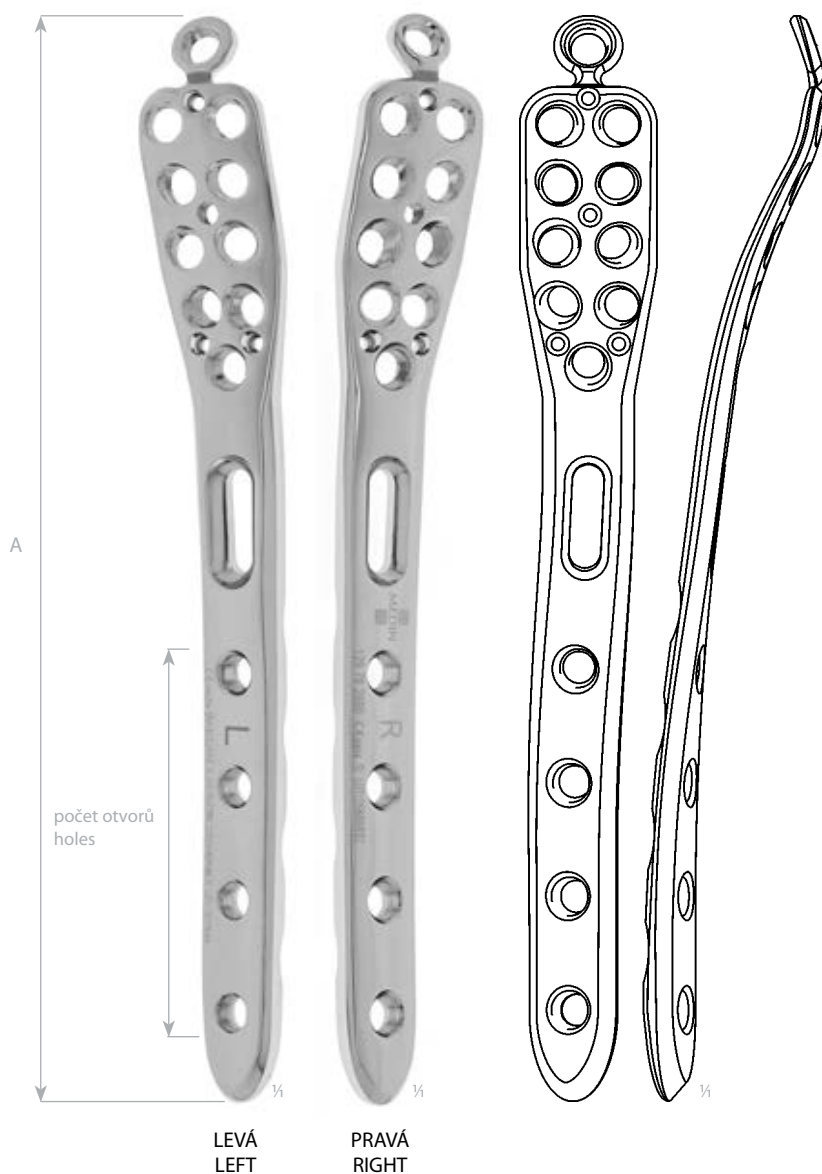
DLAHY TIBIÁLNÍ DISTÁLNÍ MEDIÁLNÍ ÚHLOVĚ STABILNÍ
DISTAL MEDIAL TIBIAL PLATES ANGULARLY STABLE

Dlaha tibiální distální mediální úhlově stabilní, levá
Distal medial tibial plate angularly stable, left

SSt	Ti	A	počet otvorů holes
397 129 78 2760	397 129 78 2763	113 mm	2
397 129 78 2780	397 129 78 2783	143 mm	4
397 129 78 2800	397 129 78 2803	173 mm	6
397 129 78 2820	397 129 78 2823	203 mm	8
397 129 78 2840	397 129 78 2843	233 mm	10
397 129 78 2860	397 129 78 2863	263 mm	12

na zvláštní objednávku
for special order

397 129 78 2770	397 129 78 2773	128 mm	3
397 129 78 2790	397 129 78 2793	158 mm	5
397 129 78 2810	397 129 78 2813	188 mm	7
397 129 78 2830	397 129 78 2833	218 mm	9
397 129 78 2850	397 129 78 2853	248 mm	11

Dlaha tibiální distální mediální úhlově stabilní, pravá
Distal medial tibial plate angularly stable, right

SSt	Ti	A	počet otvorů holes
397 129 78 2870	397 129 78 2873	113 mm	2
397 129 78 2890	397 129 78 2893	143 mm	4
397 129 78 2910	397 129 78 2913	173 mm	6
397 129 78 2930	397 129 78 2933	203 mm	8
397 129 78 2950	397 129 78 2953	233 mm	10
397 129 78 2970	397 129 78 2973	263 mm	12

na zvláštní objednávku
for special order

397 129 78 2880	397 129 78 2883	128 mm	3
397 129 78 2900	397 129 78 2903	158 mm	5
397 129 78 2920	397 129 78 2923	188 mm	7
397 129 78 2940	397 129 78 2943	218 mm	9
397 129 78 2960	397 129 78 2963	248 mm	11

síla dlahy plate thickness 3,5 mm

ŠROUBY:

šrouby kostní uzamykatelné 3,5 a 3,5/2,7 mm
kortikální šrouby HA 3,5

SCREWS:

locking bone screws 3.5 and 3.5/2.7 mm
cortical screws HA 3.5



397 129 69 6040 Síto pro dlahy tibiální distální mediální
300 × 240 × 50 mm
bez implantátů

Sieve for distal medial tibial plates
300 × 240 × 50 mm
excluding implants

DLAHY FIBULÁRNÍ DISTÁLNÍ ÚHLOVĚ STABILNÍ
DISTAL FIBULAR PLATES ANGULARLY STABLE

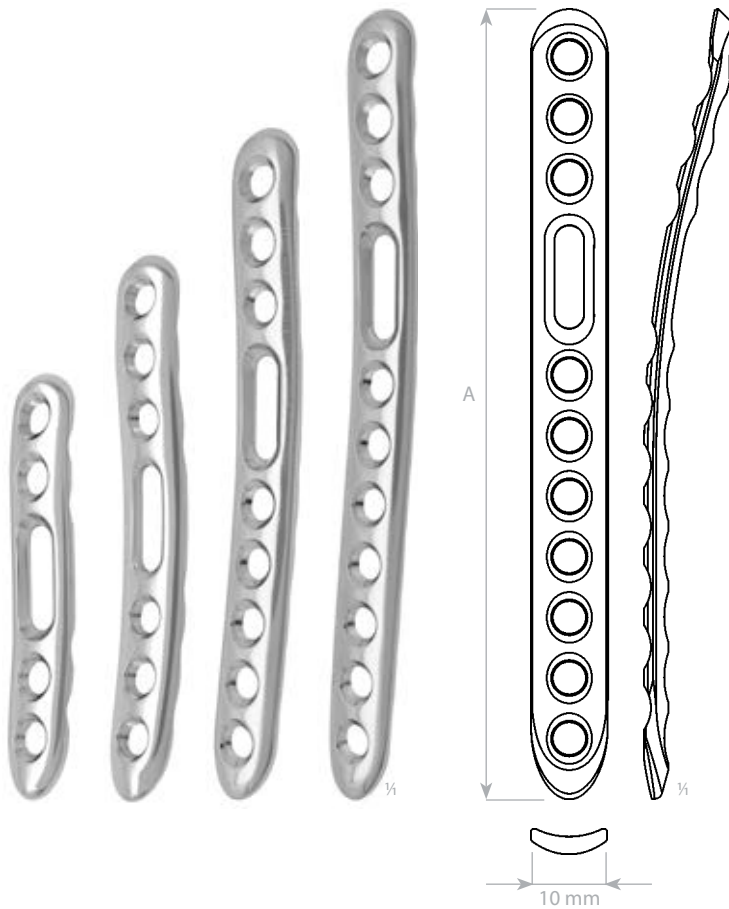

Dlaha fibulární distální úhlově stabilní
Distal fibular plate angularly stable

SSt	Ti	A	počet otvorů holes
397 129 78 5180	397 129 78 5183	57 mm	4
397 129 78 5190	397 129 78 5193	73 mm	6
397 129 78 5200	397 129 78 5203	89 mm	8
397 129 78 5210	397 129 78 5213	105 mm	10

síla dlahy	plate thickness	2,2 mm
vzdálenost otvorů	distance of holes	8 mm

ŠROUBY:
šrouby kostní uzamykatelné 3,5 a 3,5/2,7 mm
kortikální šrouby HA 3,5

SCREWS:
locking bone screws 3.5 and 3.5/2.7 mm
cortical screws HA 3.5

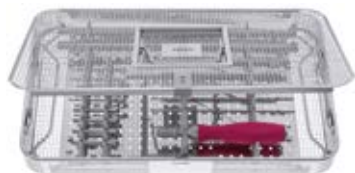
INSTRUMENTÁRIUM PRO ÚHLOVĚ STABILNÍ DLAHY SE ŠROUBY 3,5
INSTRUMENTS FOR ANGULARLY STABLE PLATES WITH SCREWS 3.5

397 139 09 0255 Instrumentárium pro USD se šrouby 3,5 mm
400 × 240 × 45 mm
včetně nástrojů

Instruments for ASP with screws 3.5 mm
400 × 240 × 45 mm
including instruments

**397 139 09 0250**

soubor

set

			ks/pcs
1	397 129 09 2550	K-drát MEDIN 1,5×300 mm	3
2	397 129 09 2570	K-drát MEDIN; 2×300 mm	3
3	B76.16.05	Toulec sterilizační 320 mm	2
4	397 129 69 3360	Pouzdro vodicí uzamykatelné 2,9×60 mm	4
5	397 129 69 3370	Pouzdro vodicí 2,9/1,6×75 mm	2
6	397 129 69 4360	Pouzdro vodicí 2,9/2×75 mm	2
7	397 129 69 7675	Hloubkoměr 80 mm	1
8	BD23-110-AO-1,5	Držadlo AO; 1,5 Nm; 30×168 mm	1
9	397 129 69 5231	Šroubovák; šestihran 2,5×160 mm	2
10	397 129 79 9981	Vrták Ø2,9×190 mm	2

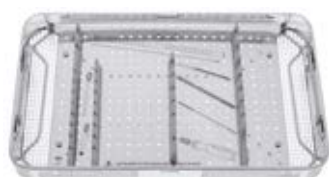

397 129 69 4390 Síto pro instrumentárium USD 3,5
400 × 240 × 45 mm
bez nástrojů

Sieve for instrumentarium ASP 3.5
400 × 240 × 45 mm
excluding instruments

Dlaha žebří
Rib plate

SSt	A	počet otvorů holes
397 129 70 7310	40 mm	4
397 129 70 7320	55 mm	4
397 129 70 7330	75 mm	5
397 129 70 7340	95 mm	6
397 129 70 7350	115 mm	7
397 129 70 7360	135 mm	8
397 129 70 7370	155 mm	9

síla dlahy _____ plate thickness _____ 1 mm

ŠROUBY:
šrouby uzamykatelné kortikální HA 3,5

SCREWS:
cortical locking screw 3.5

Šroub uzamykatelný kortikální 3,5 mm
Cortical locking screw 3.5 mm

SSt	A
397 129 70 7400	7 mm
397 129 70 7410	8 mm
397 129 70 7420	9 mm
397 129 70 7430	10 mm
397 129 70 7440	11 mm
397 129 70 7450	12 mm
397 129 70 7460	13 mm
397 129 70 7470	14 mm
397 129 70 7480	15 mm
397 129 70 7490	16 mm

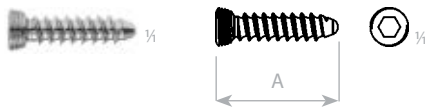
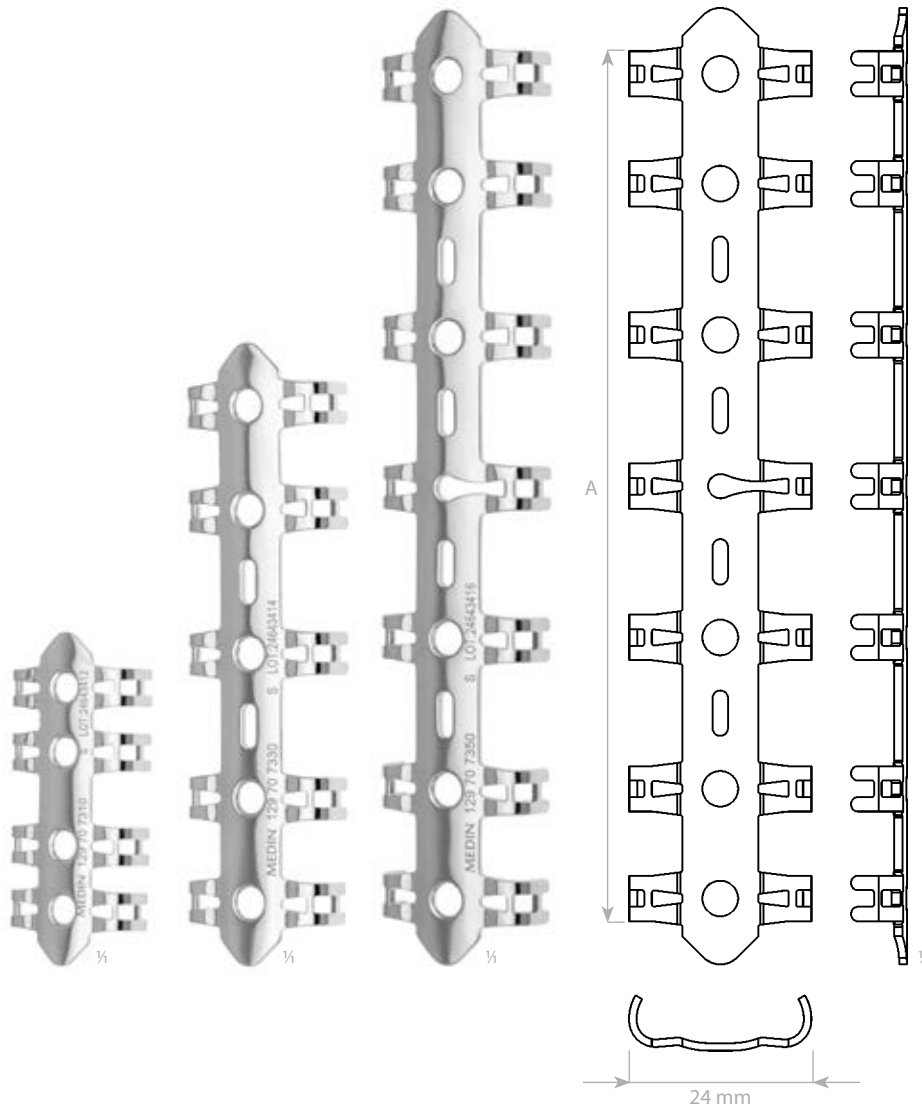

průměr závitu	thread diameter	3,5 mm
průměr jádra	core diameter	2,5 mm
průměr hlavy	head diameter	5,0 mm
vrták pro závit	drill bit for threaded hole	Ø 2,5 mm
šroubovák	screwdriver	Ø 2,5 mm

INSTRUMENTÁRIUM PRO DLAHY ŽEBERNÍ
INSTRUMENTS FOR RIB PLATES

397 139 09 0875 Instrumentárium pro dlahy žebení
540 × 240 × 70 mm
včetně nástrojů, stojánku na šrouby
a síta na dlahy žebení
bez implantátů

Instruments for rib plates
540 × 240 × 70 mm
including instruments, stand for screws and
sieve for rib plates
excluding implants

**397 139 09 0870**

soubor

set

- | | | |
|---|------------------------|------------------------------------|
| 1 | 397 117 06 0030 | Kleště na fixaci dlah, fixační |
| 2 | 397 117 08 3220 | Kleště na fixaci dlah, přidržovací |
| 3 | 397 117 06 0040 | Kleště na fixaci dlah, tvarovací |
| 4 | 397 129 68 0060 | Pouzdro 7/10 |
| 5 | 397 129 68 0070 | Pouzdro 13/16 |
| 6 | 397 129 68 0050 | Vrták D2,5 × 35 mm |
| 7 | 397 129 68 0360 | Šroubovák 2,5 × 200 mm; šestihran |

- | | |
|---|---|
| Forceps for the plate fixation, fixing | 1 |
| Forceps for the plate fixation, holding | 2 |
| Forceps for the plate fixation, shaping | 2 |
| Sleeve 7/10 | 1 |
| Sleeve 13/16 | 1 |
| Drill D2.5 × 35 mm | 3 |
| Screwdriver 2.5 × 200 mm; hexagon | 1 |

ks/pcs



397 129 68 0170 Síto na instrumentárium pro dlahy žebení
540 × 240 × 70 mm
včetně stojánku na šrouby a síta na dlahy
bez nástrojů a implantátů

Sieve for instruments for rib plates
540 × 240 × 70 mm
including stand for screws and sieve for plates
excluding instruments and implants



397 129 68 0080 Stojánek pro šrouby uzamykatelné
kortikální 3,5 mm
110 × 70 × 22 mm
bez implantátů

Stand for the locking cortical screws 3.5 mm
110 × 70 × 22 mm
excluding implants

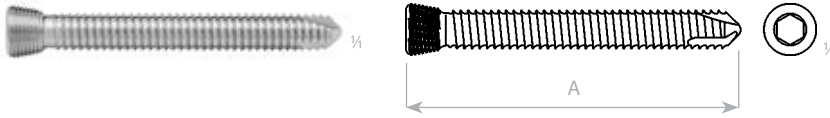
ŠROUBY KOSTNÍ UZAMYKATELNÉ 5
 LOCKING BONE SCREWS 5

průměr závitu	thread diameter	5,0 mm
průměr jádra	core diameter	4,2 mm
průměr hlavy	head diameter	6,8 mm
vrták pro závit	drill bit for threaded hole	Ø 3,9 mm
šroubovák	screwdriver	Ø 3,5 mm

Šroub kostní uzamykací 5
 Locking bone screw 5

SSt	Ti	A
397 129 77 7981	397 129 77 7984	16 mm
397 129 77 7991	397 129 77 7994	18 mm
397 129 77 8001	397 129 77 8004	20 mm
397 129 77 8011	397 129 77 8014	22 mm
397 129 77 8021	397 129 77 8024	24 mm
397 129 77 8031	397 129 77 8034	26 mm
397 129 77 8041	397 129 77 8044	28 mm
397 129 77 8051	397 129 77 8054	30 mm
397 129 77 8061	397 129 77 8064	32 mm
397 129 77 8071	397 129 77 8074	34 mm
397 129 77 8081	397 129 77 8084	36 mm
397 129 77 8091	397 129 77 8094	38 mm
397 129 77 8101	397 129 77 8104	40 mm
397 129 77 8111	397 129 77 8114	42 mm
397 129 77 8121	397 129 77 8124	44 mm
397 129 77 8131	397 129 77 8134	46 mm
397 129 77 8141	397 129 77 8144	48 mm
397 129 77 8151	397 129 77 8154	50 mm
397 129 77 8161	397 129 77 8164	55 mm
397 129 77 8171	397 129 77 8174	60 mm
397 129 77 8181	397 129 77 8184	65 mm
397 129 77 8191	397 129 77 8194	70 mm
397 129 77 8201	397 129 77 8204	75 mm
397 129 78 7401	397 129 78 7404	80 mm
397 129 78 7411	397 129 78 7414	85 mm
397 129 78 7421	397 129 78 7424	90 mm
397 129 78 7431	397 129 78 7434	95 mm
397 129 78 7441	397 129 78 7444	100 mm
397 129 78 7451	397 129 78 7454	105 mm

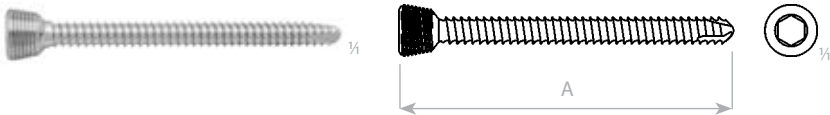

průměr závitu	thread diameter	3,5 mm
průměr jádra	core diameter	2,9 mm
průměr hlavy	head diameter	6,8 mm
vrták pro závit	drill bit for threaded hole	Ø 2,7 mm
šroubovák	screwdriver	Ø 3,5 mm

Šroub kostní uzamykací 5/3,5
 Locking bone screw 5/3.5

SSt	Ti	A
397 129 77 8231	397 129 77 8234	16 mm
397 129 77 8241	397 129 77 8244	18 mm
397 129 77 8251	397 129 77 8254	20 mm
397 129 77 8261	397 129 77 8264	22 mm
397 129 77 8271	397 129 77 8274	24 mm
397 129 77 8281	397 129 77 8284	26 mm
397 129 77 8291	397 129 77 8294	28 mm
397 129 77 8301	397 129 77 8304	30 mm
397 129 77 8311	397 129 77 8314	32 mm
397 129 77 8321	397 129 77 8324	34 mm
397 129 77 8331	397 129 77 8334	36 mm
397 129 77 8341	397 129 77 8344	38 mm
397 129 77 8351	397 129 77 8354	40 mm
397 129 77 8361	397 129 77 8364	42 mm
397 129 77 8371	397 129 77 8374	44 mm
397 129 77 8381	397 129 77 8384	46 mm
397 129 77 8391	397 129 77 8394	48 mm
397 129 77 8401	397 129 77 8404	50 mm
397 129 77 8411	397 129 77 8414	55 mm
397 129 77 8421	397 129 77 8424	60 mm
397 129 77 8431	397 129 77 8434	65 mm
397 129 77 8441	397 129 77 8444	70 mm
397 129 77 8451	397 129 77 8454	75 mm
397 129 78 7471	397 129 78 7474	80 mm
397 129 78 7481	397 129 78 7484	85 mm
397 129 78 7491	397 129 78 7494	90 mm
397 129 78 7501	397 129 78 7504	95 mm
397 129 78 7511	397 129 78 7514	100 mm
397 129 78 7521	397 129 78 7524	105 mm

ŠROUBY KOSTNÍ UZAMYKATELNÉ 5/3,5

LOCKING BONE SCREWS 5/3.5



397 129 69 5741 Stojánek na šrouby uzamykatelné 5
214 × 186 × 120 mm
bez implantátů

Stand for locking screws 5
214 × 186 × 120 mm
excluding implants



397 129 69 6392 Stojánek na šrouby uzamykatelné 5
214 × 126 × 120 mm
bez implantátů

Stand for locking screws 5
214 × 126 × 120 mm
excluding implants



397 129 69 6390 Stojánek na šrouby uzamykatelné 5/3,5
214 × 126 × 120 mm
bez implantátů

Stand for locking screws 5/3.5
214 × 126 × 120 mm
excluding implants

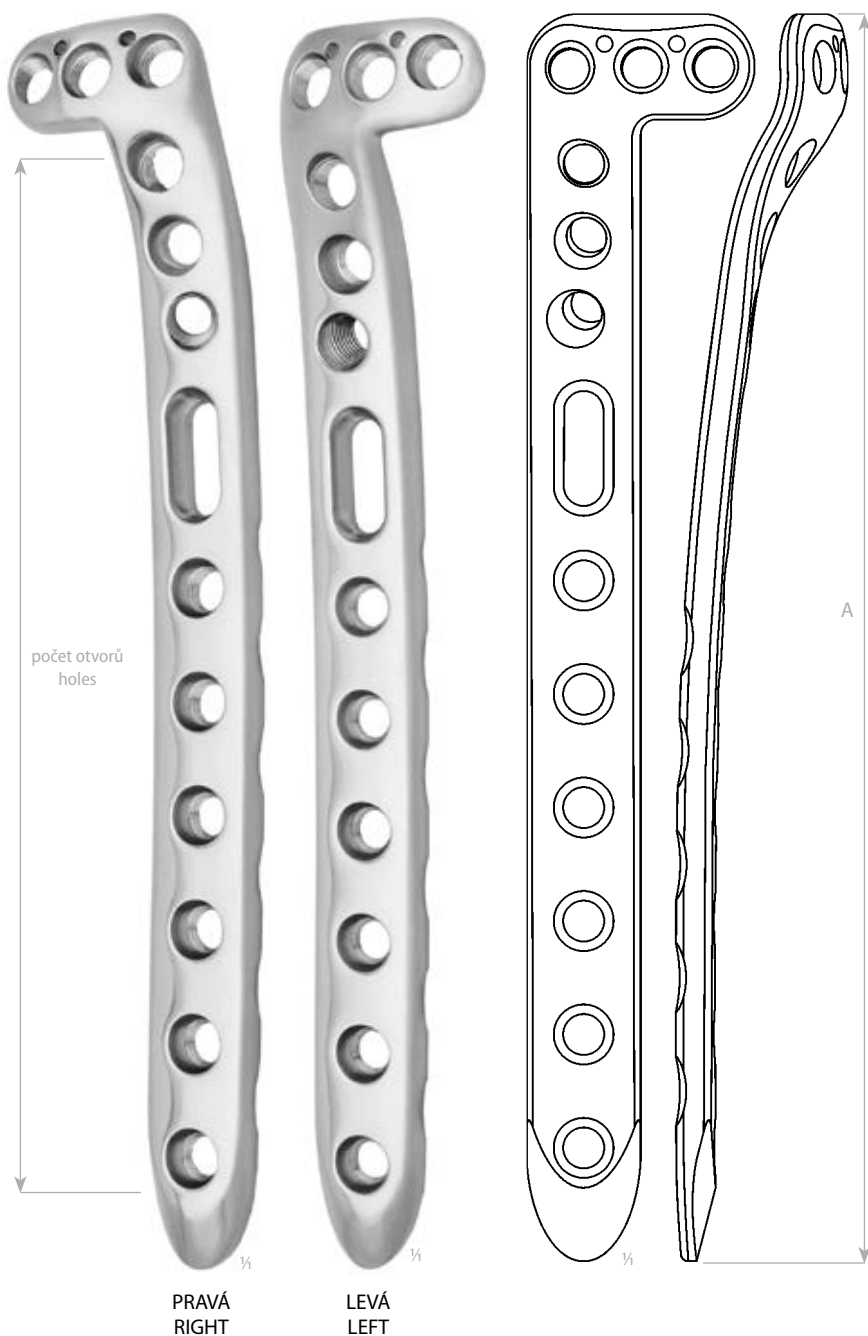
DLAHY TIBIÁLNÍ PROXIMÁLNÍ ÚHLOVĚ STABILNÍ
 PROXIMAL TIBIAL PLATES ANGULARLY STABLE

Dlaha tibiální proximální úhlově stabilní, pravá
 Proximal tibial plate angularly stable, right

SSt	Ti	A	počet otvorů holes
397 129 78 2350	397 129 78 2353	135 mm	8
397 129 78 2370	397 129 78 2373	165 mm	10
397 129 78 2390	397 129 78 2393	195 mm	12
397 129 78 2410	397 129 78 2413	225 mm	14
397 129 78 2450	397 129 78 2453	285 mm	18

na zvláštní objednávku – for special order

397 129 78 2340	397 129 78 2343	120 mm	7
397 129 78 2360	397 129 78 2363	150 mm	9
397 129 78 2380	397 129 78 2383	180 mm	11
397 129 78 2400	397 129 78 2403	210 mm	13
397 129 78 2420	397 129 78 2423	240 mm	15
397 129 78 2430	397 129 78 2433	255 mm	16
397 129 78 2440	397 129 78 2443	270 mm	17
397 129 78 2460	397 129 78 2463	300 mm	19

Dlaha tibiální proximální úhlově stabilní, levá
 Proximal tibial plate angularly stable, left

SSt	Ti	A	počet otvorů holes
397 129 78 2490	397 129 78 2493	135 mm	8
397 129 78 2510	397 129 78 2513	165 mm	10
397 129 78 2530	397 129 78 2533	195 mm	12
397 129 78 2550	397 129 78 2553	225 mm	14
397 129 78 2590	397 129 78 2593	285 mm	18

na zvláštní objednávku – for special order

397 129 78 2480	397 129 78 2483	120 mm	7
397 129 78 2500	397 129 78 2503	150 mm	9
397 129 78 2520	397 129 78 2523	180 mm	11
397 129 78 2540	397 129 78 2543	210 mm	13
397 129 78 2560	397 129 78 2563	240 mm	15
397 129 78 2570	397 129 78 2573	255 mm	16
397 129 78 2580	397 129 78 2583	270 mm	17
397 129 78 2600	397 129 78 2603	300 mm	19

síla dlahy	plate thickness	4,5 mm
vzdálenost otvorů	distance of holes	15 mm

ŠROUBY:

 šrouby kostní uzamykatelné 5 a 5/3,5 mm
 kortikální šrouby HA 4,5
 kortikální šrouby HA 5

SCREWS:

 locking bone screws 5 and 5/3.5 mm
 cortical screws HA 4.5
 cortical screws HA 5

397 129 69 5920 Síto pro dlahy tibiální proximální
 300 × 240 × 50 mm
 bez implantátů

 Sieve for proximal tibial plates
 300 × 240 × 50 mm
 excluding implants

 Síto slouží pro uložení: dlah tibiálních proximálních pravých 8; 10; 12; 14; 18 otvorů (5×1 ks) a dlah tibiálních proximálních levých 8; 10; 12; 14; 18 otvorů (5×1 ks).
 Sieve is for keeping of: right tibial proximal plates 8; 10; 12; 14; 18 holes (5×1 piece) and left tibial proximal plates 8; 10; 12; 14; 18 holes (5×1 piece).

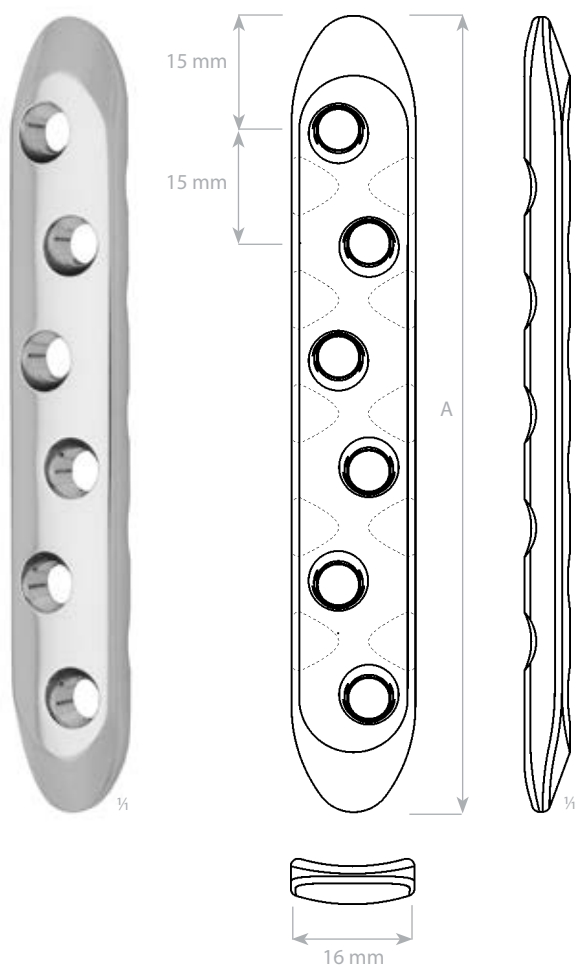
DLAHY PŘÍMÉ ÚHLOVĚ STABILNÍ
STRAIGHT PLATES ANGULARLY STABLE

Dlaňá přímá úhlově stabilní
Straight plate angularly stable

SSt	Ti	A	počet otvorů holes
397 129 77 9330	397 129 77 9333	75 mm	4
397 129 77 9340	397 129 77 9343	90 mm	5
397 129 77 9350	397 129 77 9353	105 mm	6
397 129 77 9360	397 129 77 9363	120 mm	7
397 129 77 9370	397 129 77 9373	135 mm	8
397 129 77 9380	397 129 77 9383	150 mm	9
397 129 77 9390	397 129 77 9393	165 mm	10
397 129 77 9400	397 129 77 9403	180 mm	11
397 129 77 9410	397 129 77 9413	195 mm	12

síla dlahy	plate thickness	5,0 mm
vzdálenost otvorů	distance of holes	15 mm

ŠROUBY:
šrouby kostní uzamykatelné 5 a 5/3,5 mm
kortikální šrouby HA 4,5
kortikální šrouby HA 5

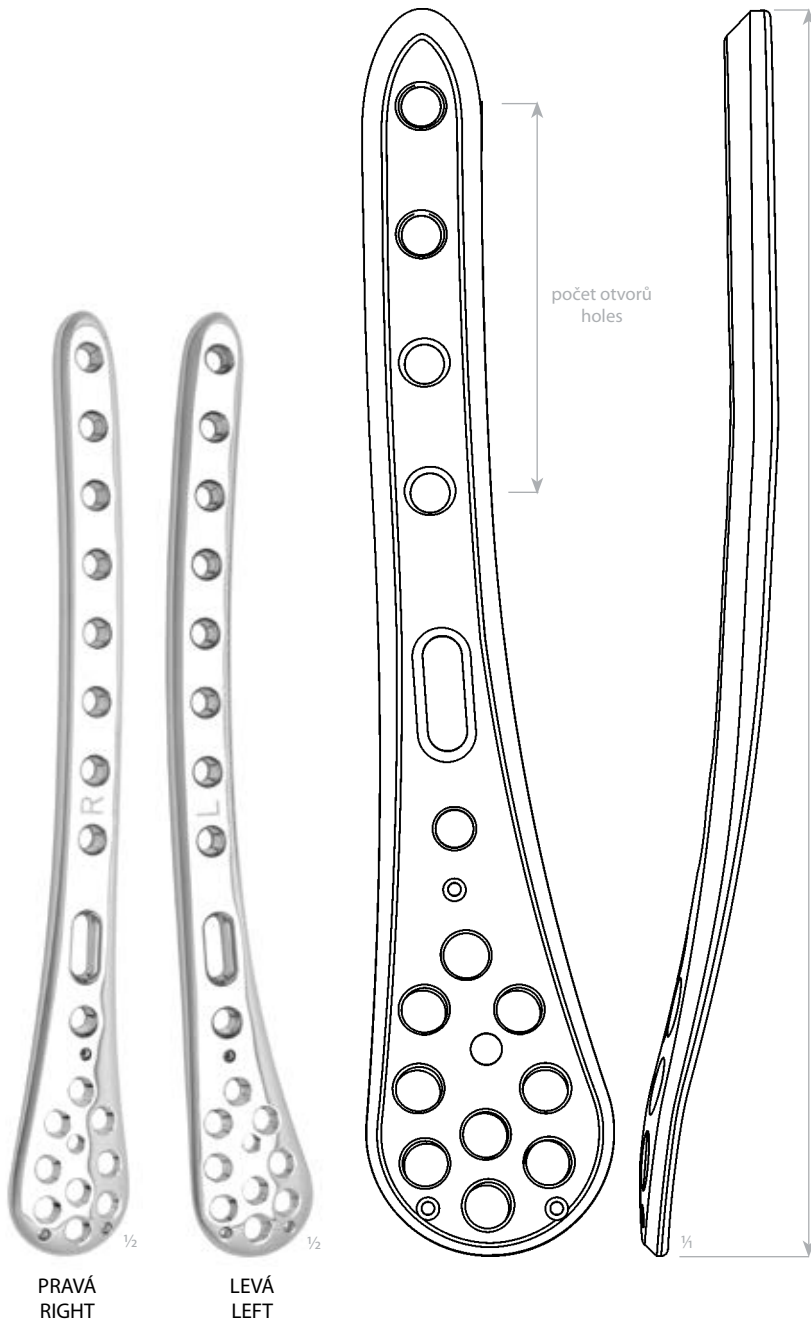
SCREWS:
locking bone screws 5 and 5/3.5 mm
cortical screws HA 4.5
cortical screws HA 5

DLAHY FEMORÁLNÍ DISTÁLNÍ ÚHLOVĚ STABILNÍ
 DISTAL FEMORAL PLATES ANGULARLY STABLE

Dlaha femorální distální úhlově stabilní, pravá
 Distal femoral plate angularly stable, right

SSt	Ti	A	počet otvorů holes
397 129 77 9580	397 129 77 9583	165 mm	4
397 129 77 9590	397 129 77 9593	202 mm	6
397 129 77 9600	397 129 77 9603	232 mm	8
397 129 77 9610	397 129 77 9613	266 mm	10
397 129 77 9620	397 129 77 9623	299 mm	12
397 129 78 6900	397 129 78 6903	336 mm	14

Dlaha femorální distální úhlově stabilní, levá
 Distal femoral plate angularly stable, left

SSt	Ti	A	počet otvorů holes
397 129 77 9520	397 129 77 9523	165 mm	4
397 129 77 9530	397 129 77 9533	202 mm	6
397 129 77 9540	397 129 77 9543	232 mm	8
397 129 77 9550	397 129 77 9553	266 mm	10
397 129 77 9560	397 129 77 9563	299 mm	12
397 129 78 6890	397 129 78 6893	336 mm	14

síla dlahy	plate thickness	6,0 mm
vzdálenost otvorů	distance of holes	17 mm

ŠROUBY:

šrouby kostní uzamykatelné 5 a 5/3,5 mm
 kortikální šrouby HA 4,5
 kortikální šrouby HA 5

Kompatibilní s periprotetickými objímkami.

SCREWS:

locking bone screws 5 and 5/3.5 mm
 cortical screws HA 4.5
 cortical screws HA 5

Compatible with periprosthetic clamps.



397 129 69 6230 Síto pro dlahy femorální distální
 540 × 240 × 50 mm
 bez implantátů

Sieve for distal femoral plates
 540 × 240 × 50 mm
 excluding implants

Síto slouží pro uložení: dlah femorálních distálních pravých 4; 6; 8; 10; 12; 14 otvorů (6×1 ks) a dlah femorálních distálních levých 4; 6; 8; 10; 12; 14 otvorů (6×1 ks).

Sieve is for keeping of: right femoral distal plates 4; 6; 8; 10; 12; 14 holes (6×1 piece) and left femoral distal plates 4; 6; 8; 10; 12; 14 holes (6×1 piece).

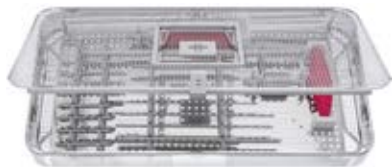
INSTRUMENTÁRIUM PRO ÚHLOVĚ STABILNÍ DLAHY SE ŠROUBY 5
INSTRUMENTS FOR ANGULARLY STABLE PLATES WITH SCREWS 5

397 139 09 0265 Set instrumentária pro USD
se šrouby 5 a 5/3,5 mm
480 × 240 × 50 mm
včetně nástrojů

Set of instruments for ASP with
screws 5 and 5/3.5 mm
480 × 240 × 50 mm
including instruments

**397 139 09 0260**

soubor

set

1	397 129 09 2550	K-drát MEDIN; 1,5×300 mm
2	B76.16.05	Toulec sterilizační 320 mm
3	397 129 69 4300	Pouzdro 6,8/4×80 mm uzamykatelné
4	397 129 69 4410	Pouzdro vodící 3,9/1,8×95 mm
5	397 129 69 4430	Pouzdro vodící 3,9/3×95 mm
6	397 129 69 8890	Hloubkoměr 120 mm
7	BD28-120-AO-4,0	Držadlo AO; 4,0 Nm; 38×171 mm
8	BT23-116-AO-4Nm	Držadlo T AO; 4,0 Nm; 116×129 mm
9	397 129 69 5251	Šroubovák; šestihran 3,5 mm
10	397 129 69 5141	Vrták 3,9×220 mm
11	397 129 69 5201	Vrták 2,9×220 mm

		K-wire MEDIN; 1.5×300 mm
		Kirschner wire tube 32 cm 12 mm
		Guide sleeve locking; 6.8/4.0×80 mm
		Guide sleeve 3.9/1.8×95 mm
		Guide sleeve 3.9/3×95 mm
		Depth gauge; 120 mm
		Handle AO; 4,0 Nm; 38×171 mm
		T-handle AO; 4,0 Nm; 116×129 mm
		Screwdriver; hexagon 3.5 mm
		Drill 3.9×220 mm
		Drill 2.9×220 mm

ks/pcs

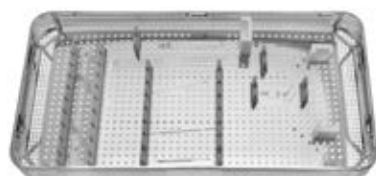
3
1
4
2
2
1
1
1
2
1
1

397 129 69 5180 Síto pro instrumentarium USD 5
480 × 240 × 50 mm
bez nástrojů

Sieve for instrumentarium ASP 5
480 × 240 × 50 mm
excluding instruments

INSTRUMENTÁRIUM PRO DLAHY FEMORÁLNÍ DISTÁLNÍ
INSTRUMENTS FOR DISTAL FEMORAL PLATES



397 139 09 0325 Instrumentárium pro dlahy femorální distální
540 × 240 × 90 mm
včetně nástrojů

Instruments for distal femoral plates
540 × 240 × 90 mm
including instruments

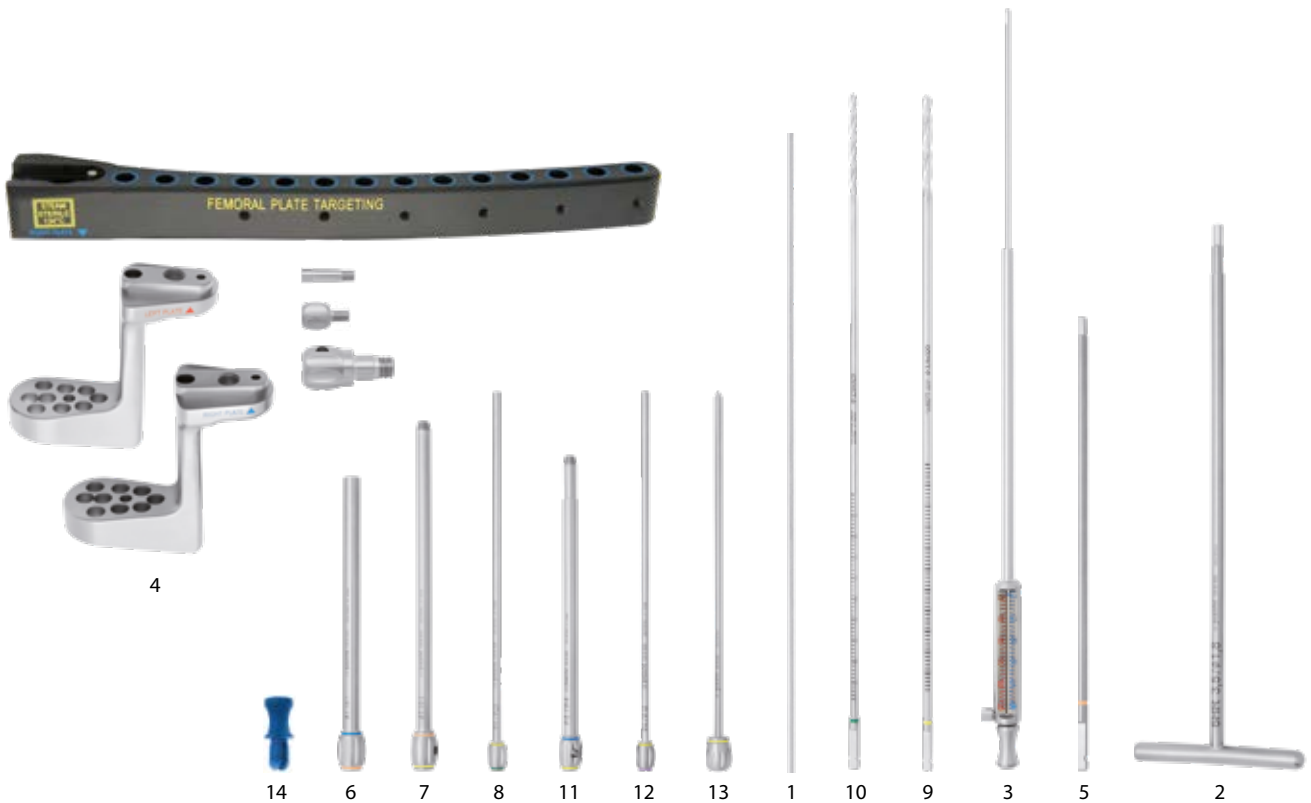

397 139 09 0320

soubor

set

ks/pcs

1	397 129 09 2550	K-drát MEDIN Ø 1,5 mm; 300 mm
2	397 129 69 4056	T-šroubovák; šestihran 3,5 mm
3	397 129 69 4785	Hloubkoměr
4	397 129 69 4800	Cílič pro dlahu femorální distální
5	397 129 69 5256	Šroubovák; šestihran 3,5 mm
6	397 129 69 5600	Pouzdro vodící Ø 8/7 mm; 150 mm
7	397 129 69 5610	Pouzdro vrtací Ø 7/4 mm; 180 mm
8	397 129 69 5620	Pouzdro vodící Ø 4/2,9 mm; 195 mm
9	397 129 69 5631	Vrták Ø 4,0 mm; 320 mm
10	397 129 69 5641	Vrták Ø 2,9 mm; 320 mm
11	397 129 69 5650	Pouzdro upevňovací Ø 8/4 mm; 180 mm
12	397 129 69 5930	Pouzdro vodící Ø 4/1,8 mm; 195 mm
13	397 129 69 6330	Trokar Ø 4 mm; 210 mm
14	397 129 69 7218	Ucpávka 8x30 mm

	K-wire MEDIN Ø 1.5 mm; 300 mm	3
	T-screwdriver; hexagon 3.5 mm	1
	Depth gauge	1
	Aiming device for distal femoral plate	1
	Screwdriver; hexagon 3.5 mm	1
	Guide sleeve Ø 8/7 mm; 150 mm	4
	Drill sleeve Ø 7/4 mm; 180 mm	4
	Drill sleeve Ø 4/2.9 mm; 195 mm	2
	Drill Ø 4.0 mm; 320 mm	1
	Drill Ø 2.9 mm; 320 mm	1
	Fastening sleeve Ø 8/4 mm; 180 mm	1
	Drill sleeve Ø 4/1.8 mm; 195 mm	2
	Trocar Ø 4 mm; 210 mm	1
	Plug 8x30 mm	14

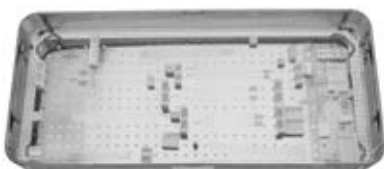

397 129 69 5900 Síto pro instrumentárium pro dlahy femorální distální
540 × 240 × 90 mm
bez nástrojů

Sieve for instrumentarium for distal femoral plates
540 × 240 × 90 mm
excluding instruments

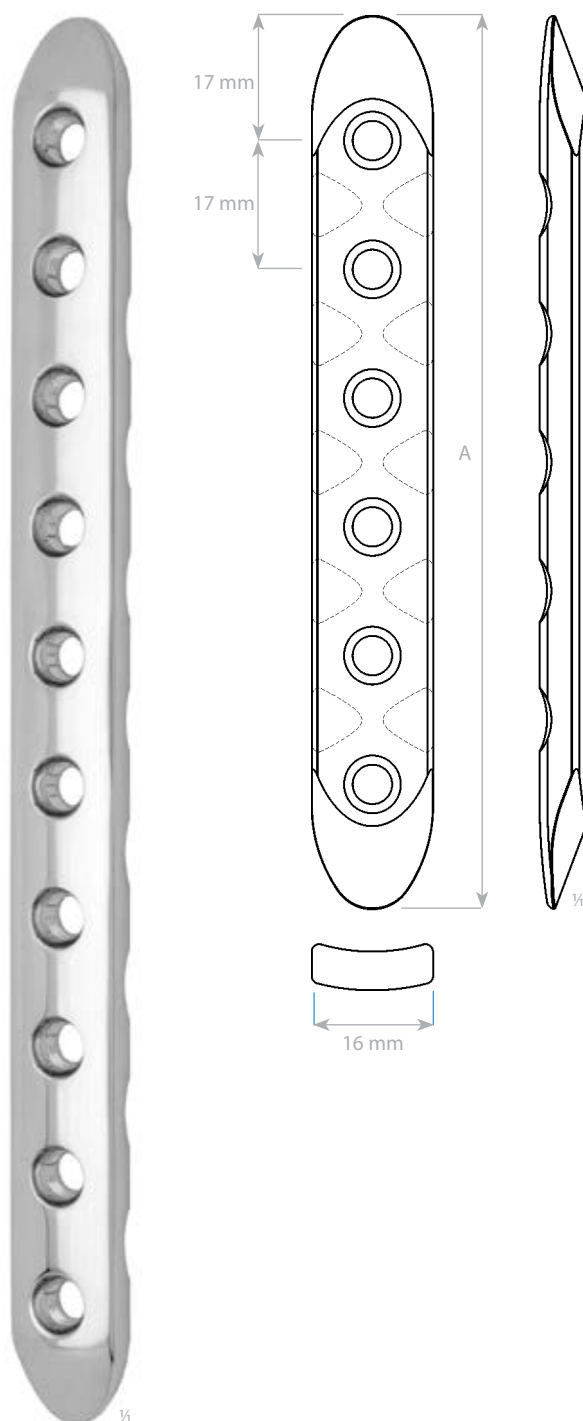
DLAHY PŘÍMÉ ÚHLOVĚ STABILNÍ
STRAIGHT PLATES ANGULARLY STABLE

Dlaha přímá úhlově stabilní
Straight plate angularly stable

	A	počet otvorů holes
397 129 78 5020	169 mm	9
397 129 78 5025	186 mm	10
397 129 78 5030	203 mm	11
397 129 78 5035	220 mm	12
397 129 78 5040	237 mm	13
397 129 78 5045	254 mm	14
397 129 78 5050	271 mm	15
397 129 78 5055	288 mm	16
397 129 78 5060	305 mm	17
397 129 78 5355	322 mm	18
397 129 78 5360	339 mm	19
397 129 78 5365	356 mm	20

síla dlahy	plate thickness	5,0 mm
vzdálenost otvorů	distance of holes	17 mm

ŠROUBY:

šrouby kostní uzamykatelné 5 a 5/3,5 mm
 kortikální šrouby HA 4,5
 kortikální šrouby HA 5

Kompatibilní s periprotetickými objímkami.

SCREWS:

locking bone screws 5 and 5/3.5 mm
 cortical screws HA 4,5
 cortical screws HA 5

Compatible with periprosthetic clamps.

DLAHY FEMORÁLNÍ PROXIMÁLNÍ ÚHLOVĚ STABILNÍ
 PROXIMAL FEMORAL PLATES ANGULARLY STABLE

 PRAVÁ
 RIGHT

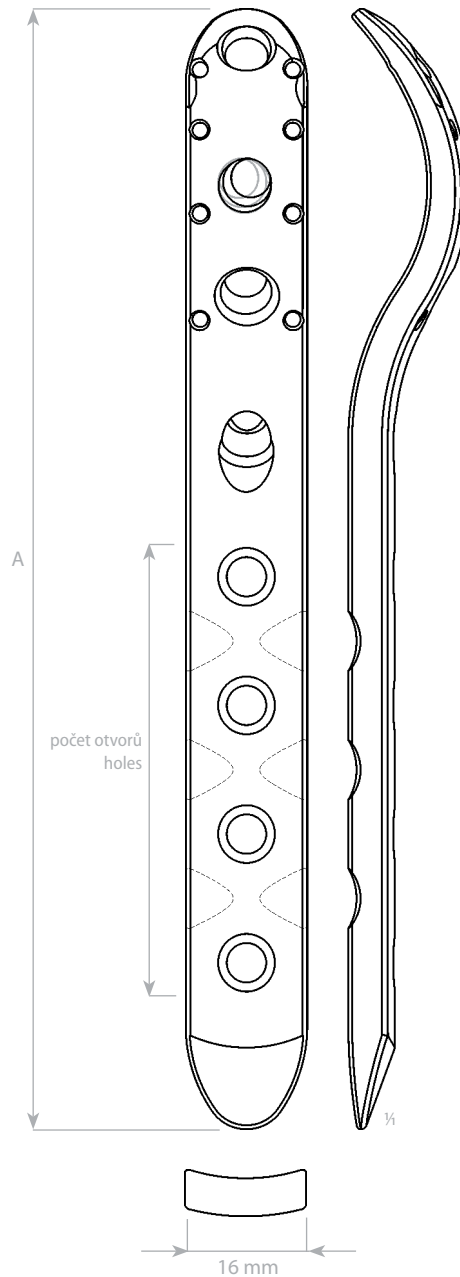
 LEVÁ
 LEFT

Dlaha femorální proximální úhlově stabilní, pravá
 Proximal femoral plate angularly stable, right

	A	počet otvorů holes
397 129 78 5065	114 mm	2
397 129 78 5070	148 mm	4
397 129 78 5075	182 mm	6
397 129 78 5080	216 mm	8
397 129 78 5085	250 mm	10
397 129 78 5090	284 mm	12
397 129 78 5095	318 mm	14
397 129 78 5100	352 mm	16
397 129 78 5105	386 mm	18
397 129 78 5110	420 mm	20

Dlaha femorální proximální úhlově stabilní, levá
 Proximal femoral plate angularly stable, left

	A	počet otvorů holes
397 129 78 5115	114 mm	2
397 129 78 5120	148 mm	4
397 129 78 5125	182 mm	6
397 129 78 5130	216 mm	8
397 129 78 5135	250 mm	10
397 129 78 5140	284 mm	12
397 129 78 5145	318 mm	14
397 129 78 5150	352 mm	16
397 129 78 5155	386 mm	18
397 129 78 5160	420 mm	20

<u>síla dlahy</u>	<u>plate thickness</u>	<u>5,0 mm</u>
<u>vzdálenost otvorů</u>	<u>distance of holes</u>	<u>17 mm</u>

ŠROUBY:
 šrouby kostní uzamykatelné 5 a 5/3,5 mm
 kortikální šrouby HA 4,5
 kortikální šrouby HA 5

Kompatibilní s periprotetickými objímkami.

SCREWS:
 locking bone screws 5 and 5/3.5 mm
 cortical screws HA 4,5
 cortical screws HA 5

Compatible with periprosthetic clamps.

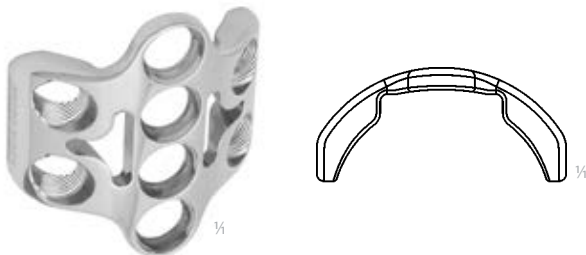
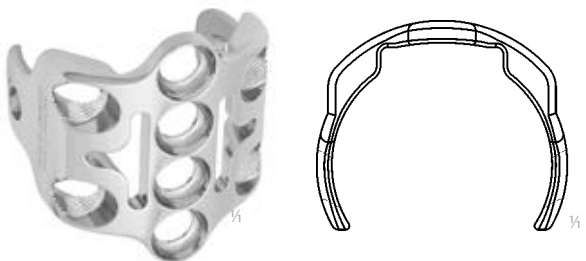
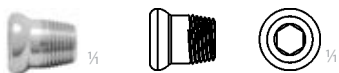
IMPLANTÁTY PRO PERIPROTETICKÉ ZLOMENINY
IMPLANTS FOR PERIPROSTHETIC FRACTURES**Objímka 1**
Clamp 1**397 129 78 3700****Objímka 2**
Clamp 2**397 129 78 3710****Objímka 3**
Clamp 3**397 129 78 3720****Šroub na objímku uzamykatelný**
Locking screw for clamp**397 129 78 5000**

šroubovák	screwdriver	Ø 3,5 mm
průměr hlavy	head diameter	8 mm

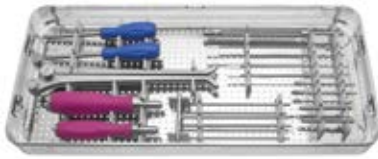
INSTRUMENTÁRIUM PRO PERIPROTETICKÉ POŠKOZENÍ FEMURU
 INSTRUMENTS FOR PERIPROSTHETIC FEMORAL FRACTURES

397 139 09 0355 Instrumentárium pro periprotetické poškození femuru
540 × 240 × 50 mm
včetně nástrojů

Instrumentarium for periprosthetic femoral fractures
540 × 240 × 50 mm
including instruments



397 139 09 0350		soubor	set	ks/pcs
1	397 129 69 5141	Vrták Ø3,9×220	Drill; 3.9×220 mm	2
2	397 129 79 9981	Vrták Ø2,9×190 mm	Drill; 2.9×190 mm	2
3	397 129 69 4300	Pouzdro 6,8/4×80 mm uzamykatelné	Guide sleeve locking; 6.8/4.0×80 mm	2
4	397 129 69 4430	Pouzdro vodící 3,9/3×95 mm	Guide sleeve 3.9/3×95 mm	2
5	397 129 69 8890	Hloubkoměr 120 mm	Depth gauge; 120 mm	1
6	BD23-110-AO	Držadlo AO; 30×151 mm	Handle AO; 30×151 mm	1
7	BD28-120-AO-4,0	Držadlo AO; 4,0 Nm; 38×171 mm	Handle AO; 4,0 Nm; 38×171 mm	1
8	397 129 69 5251	Šroubovák 3,5×160 mm šestihran	Screwdriver hexagonal; 3.5×160 mm	2
9	397 129 69 4050	T-šroubovák 3,5×175 mm; šestihran	Screwdriver T hexagonal; 3.5×175 mm	1
10	397 129 68 0290	Tyč ohýbací pro objímky	Bending rod for clamps	2
11	397 129 08 4960	Ohýbačka klešťová na dlahy 11×290 mm	Plier for plates width 11×290 mm	1

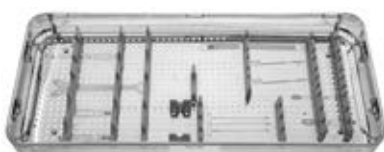

397 129 69 5045 Síto na instrumentárium pro periprotetické poškození femuru
540 × 240 × 50 mm
bez nástrojů

Sieve for instrumentarium for periprosthetic femoral fractures
540 × 240 × 50 mm
excluding instruments

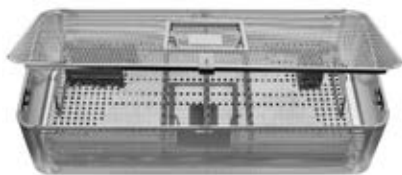
INSTRUMENTÁRIUM PRO PERIPROTETICKÉ POŠKOZENÍ FEMURU
INSTRUMENTS FOR PERIPROSTHETIC FEMORAL FRACTURES

397 129 69 5040 Síto na implantáty pro periprotetické poškození femuru
540 × 240 × 130 mm
bez implantátů

Sieve for implants for periprosthetic femoral fractures
540 × 240 × 130 mm
excluding instruments

Síto slouží pro uložení: dlah přímých 9–20 otvorů (10×1 ks), dlah femorálních proximálních pravých 2–20 otvorů (10×1 ks), dlah femorálních proximálních levých 2–20 otvorů (10×1 ks), objímek 1 (3 ks), objímek 2 (6 ks), objímek 3 (3 ks) a šroubů na objímku (10 ks).
Sieve is for keeping of: straight plates 9–20 holes (10×1 piece), right femoral proximal plates 2–20 holes (10×1 piece), left femoral proximal plates 2–20 holes (10×1 piece), clamps 1 (3 pcs), clamps 2 (6 pcs), clamps 3 (3 pcs) and locking screws for clamp (10 pcs).



397 129 69 6392 Stojánek na šrouby uzamykatelné 5
214 × 126 × 120 mm
bez implantátů

Stand for locking screws 5
214 × 126 × 120 mm
excluding implants



397 129 69 6390 Stojánek na šrouby uzamykatelné 5/3,5
214 × 126 × 120 mm
bez implantátů

Stand for locking screws 5/3.5
214 × 126 × 120 mm
excluding implants



397 129 69 6391 Stojánek na šrouby kortikální 4,5
214 × 126 × 120 mm
bez implantátů

Stand for cortical screws 4.5
214 × 126 × 120 mm
excluding implants



D

DLAHY PLATES



D

DLAHY PLATES



Dlahy

Dlahy se zmenšenou plochou doteku

Dlahy autokompresní

Dlahy rekonstrukční

Dlahy přímé

Dlahy žlábkové

Dlahy pánevní flexibilní

Dlahy pánevní OMEGA

Instrumentárium pro dlahy pánevní OMEGA

Instrumentárium pro dlahy

Plates

Limited contact plates

Self-compression plates

Reconstruction plates

Straight plates

Tubular plates

Flexible pelvic plates

OMEGA pelvic plates

Instruments for OMEGA pelvic plates

Instruments for plates

D.1

1

2-3

3

4-5

6

7

8

9

10

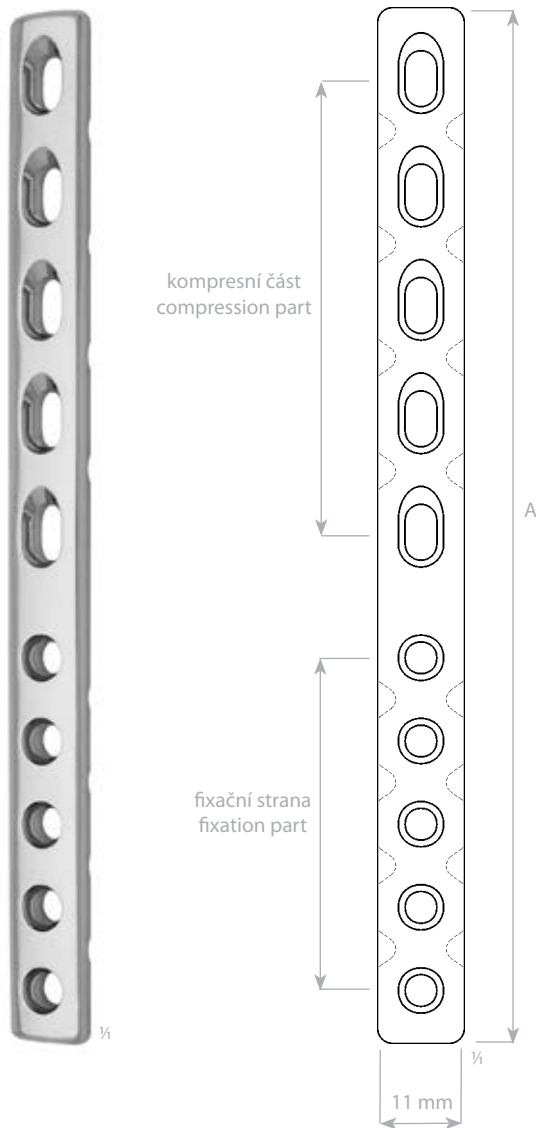
DLAHY SE ZMENŠENOU PLOCHOU DOTEKU
LIMITED CONTACT PLATES

Dlaha se zmenšenou plochou doteku
Limited contact plate

SSt	otvorů holes	fixačních fixation	kompresních compression	A
397 129 77 4100	4	2	2	59 mm
397 129 77 4110	5	2	3	74 mm
397 129 77 4120	6	3	3	85 mm
397 129 77 4130	7	3	4	100 mm
397 129 77 4140	8	4	4	111 mm
397 129 77 4150	9	4	5	126 mm
397 129 77 4160	10	5	5	137 mm

síla dlahy	plate thickness	3,5 mm
vzdálenost otvorů	distance of holes	15 / 11 mm

ŠROUBY:
 kortikální šrouby HA 3,5
 spongiozní šrouby HB 4

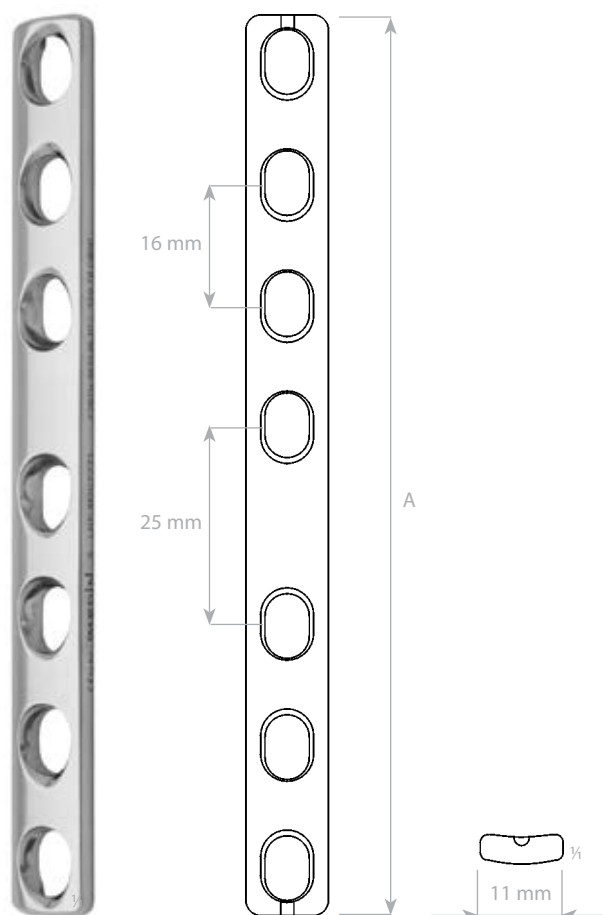
SCREWS:
 cortical screws HA 3.5
 cancellous screws HB 4

Dlaha autokompresní
 Self-compression plate

SSt	A	otvorů holes
397 129 78 0750	39 mm	2
397 129 78 0760	55 mm	3
397 129 78 0770	71 mm	4
397 129 78 0780	87 mm	5
397 129 78 0790	103 mm	6
397 129 78 0800	119 mm	7
397 129 78 0810	135 mm	8
397 129 78 0820	151 mm	9
397 129 78 0830	167 mm	10
397 129 78 0840	183 mm	11
397 129 78 0850	199 mm	12
397 129 78 0860	215 mm	13
397 129 78 0870	231 mm	14
397 129 78 0880	247 mm	15
397 129 78 0890	263 mm	16

síla dlahy	plate thickness	3,5 mm
vzdálenost otvorů	distance of holes	16 mm

ŠROUBY:

kortikální šrouby HA 4,5
 spongiozní šrouby HB 6,5

Na obou koncích dlahy jsou otvory pro spongiozní šroub, do 7 otvorů po 1, od 8 otvorů po 2.

SCREWS:

cortical screws HA 4.5
 cancellous screws HB 6.5

Endholes of plate for cancellous screws HB 6.5; 2-7: 1 hole on each end; 8-16: 2 holes on each end.

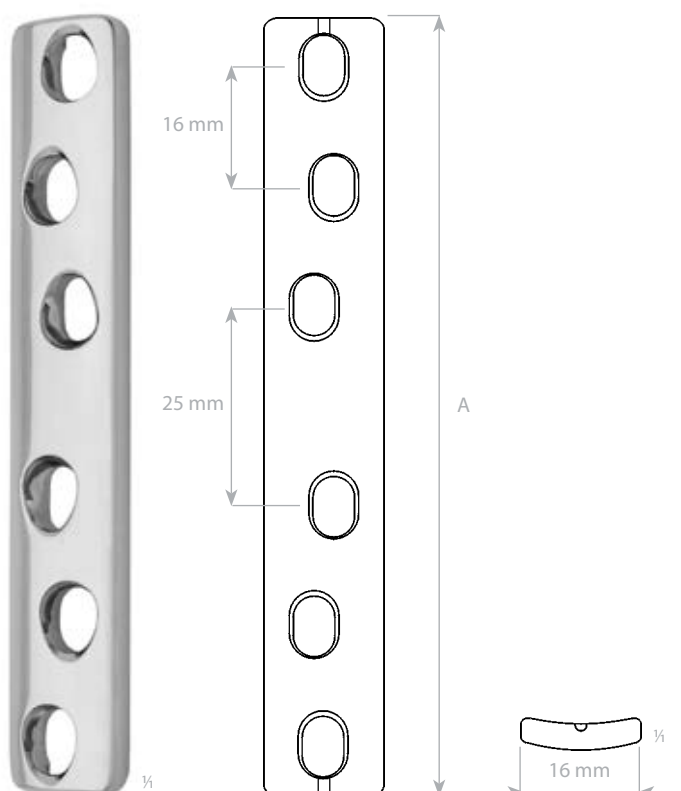
Dlaha autokompresní
 Self-compression plate

SSt	A	otvorů holes
397 129 78 1370	87 mm	5
397 129 78 0900	103 mm	6
397 129 78 0910	119 mm	7
397 129 78 0920	135 mm	8
397 129 78 0930	151 mm	9
397 129 78 0940	167 mm	10
397 129 78 0950	199 mm	12
397 129 78 0960	231 mm	14
397 129 78 0970	263 mm	16
397 129 78 0980	295 mm	18

síla dlahy	plate thickness	3,5 mm
vzdálenost otvorů	distance of holes	16 mm

ŠROUBY:

kortikální šrouby HA 4,5
 spongiozní šrouby HB 6,5

Na obou koncích dlahy jsou otvory pro spongiozní šroub, do 7 otvorů po 1, od 8 otvorů po 2.

SCREWS:

cortical screws HA 4.5
 cancellous screws HB 6.5

Endholes of plate for cancellous screws HB 6.5; 2-7: 1 hole on each end; 8-16: 2 holes on each end.

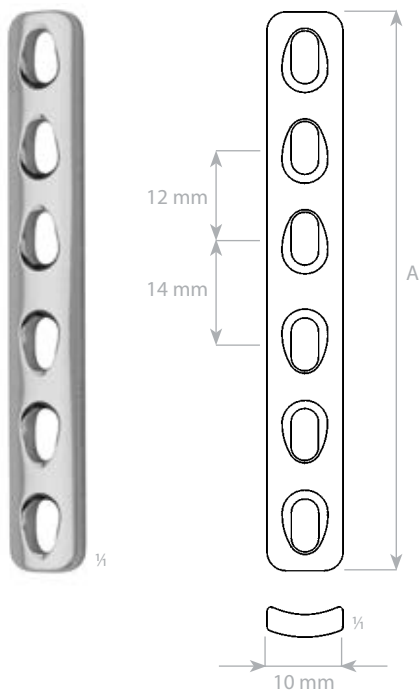
**DLAHY AUTOKOMPRESNÍ
SELF-COMPRESSION PLATES**

**Dlahy autokompresní
Self-compression plate**

SSt	A	otvorů holes
397 129 77 1010	38 mm	3
397 129 77 1020	50 mm	4
397 129 77 1030	62 mm	5
397 129 77 1040	74 mm	6
397 129 77 1050	86 mm	7
397 129 77 1060	98 mm	8

síla dlahy	plate thickness	3,0 mm
vzdálenost otvorů	distance of holes	12 mm

ŠROUBY:
kortikální šrouby HA 3,5
spongiozní šrouby HB 4

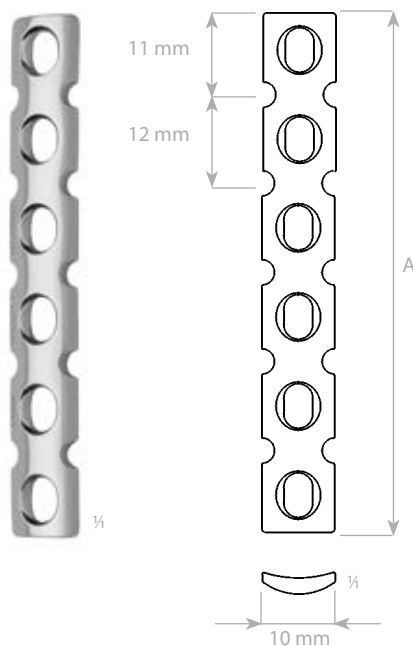
SCREWS:
cortical screws HA 3.5
cancellous screws HB 4

**DLAHY REKONSTRUKČNÍ
RECONSTRUCTION PLATES**

**Dlaha rekonstrukční
Reconstruction plate**

SSt	A	otvorů holes
397 129 77 0490	46 mm	4
397 129 77 0500	58 mm	5
397 129 77 0510	70 mm	6
397 129 77 0520	82 mm	7
397 129 77 0530	94 mm	8
397 129 77 3790	106 mm	9
397 129 77 3800	118 mm	10
397 129 77 4060	130 mm	11
397 129 77 4070	142 mm	12

síla dlahy	plate thickness	2,2 mm
vzdálenost otvorů	distance of holes	12 mm

ŠROUBY:
kortikální šrouby HA 3,5

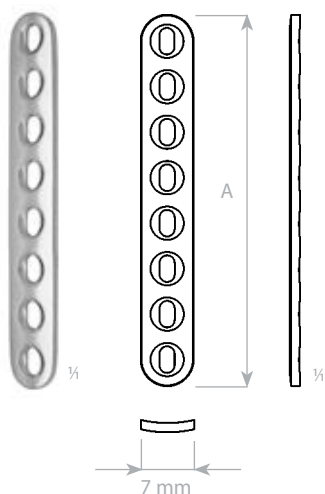
SCREWS:
cortical screws HA 3.5

**Dlaha přímá**
Straight plate

SSt	A	otvorů holes
397 129 78 4340	19 mm	3
397 129 78 4350	25 mm	4
397 129 78 4360	31 mm	5
397 129 78 4370	37 mm	6
397 129 78 4380	43 mm	7
397 129 78 4390	49 mm	8
397 129 78 4400	55 mm	9
397 129 78 4410	61 mm	10
397 129 78 4420	67 mm	11
397 129 78 4430	73 mm	12

síla dlahy	plate thickness	1,2 mm
vzdálenost otvorů	distance of holes	6 mm

ŠROUBY:
kortikální šrouby HA 2

SCREWS:
cortical screws HA 2

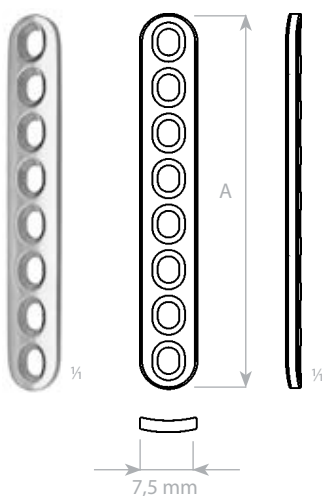
**Dlaha přímá**
Straight plate

SSt	A	otvorů holes
397 129 78 4230	25 mm	4
397 129 78 4240	31 mm	5
397 129 78 4250	37 mm	6
397 129 78 4260	43 mm	7
397 129 78 4270	49 mm	8
397 129 78 4280	55 mm	9
397 129 78 4290	61 mm	10
397 129 78 4300	67 mm	11
397 129 78 4310	73 mm	12
397 129 78 4320	79 mm	13
397 129 78 4330	85 mm	14

síla dlahy	plate thickness	1,2 mm
vzdálenost otvorů	distance of holes	6 mm

ŠROUBY:
kortikální šrouby HA 2,7

SCREWS:
cortical screws HA 2.7

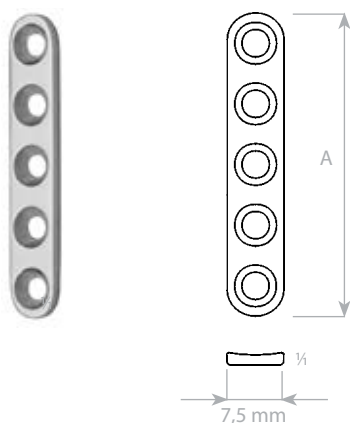

Dlaha přímá
Straight plate

SSt	A	otvorů holes
397 129 77 0540	24 mm	3
397 129 77 0550	32 mm	4
397 129 77 0560	40 mm	5
397 129 77 0570	48 mm	6
397 129 77 0580	56 mm	7
397 129 77 0590	64 mm	8

<u>síla dlahy</u>	<u>plate thickness</u>	<u>1,2 mm</u>
<u>vzdálenost otvorů</u>	<u>distance of holes</u>	<u>8 mm</u>

ŠROUBY:
kortikální šrouby HA 3,5

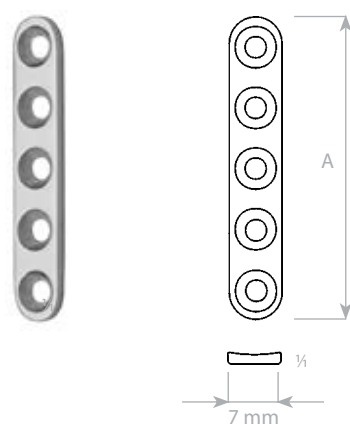
SCREWS:
cortical screws HA 3.5



Dlaha přímá
Straight plate

SSt	A	otvorů holes
397 129 99 0252	24 mm	3
397 129 99 0253	32 mm	4
397 129 99 0254	40 mm	5
397 129 99 0255	48 mm	6
397 129 99 0256	56 mm	7
397 129 99 0257	64 mm	8

<u>síla dlahy</u>	<u>plate thickness</u>	<u>1,2 mm</u>
<u>vzdálenost otvorů</u>	<u>distance of holes</u>	<u>8 mm</u>

ŠROUBY:
kortikální šrouby HA 2,7

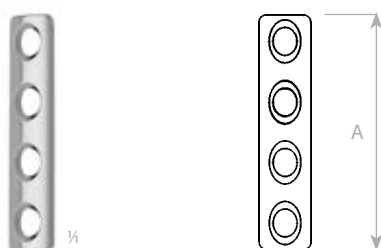
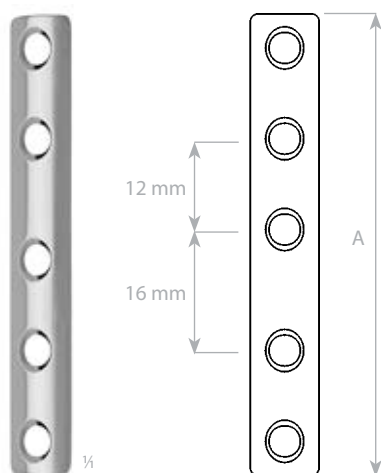
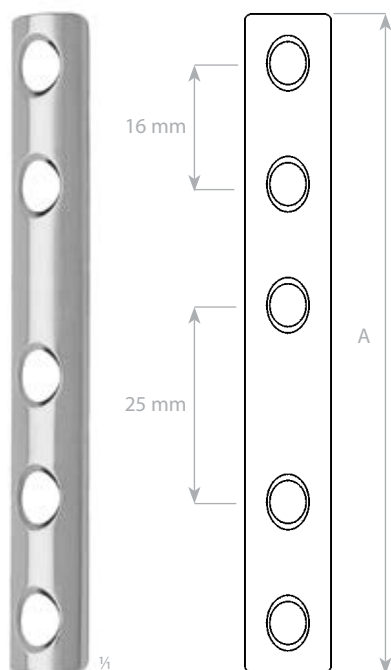
SCREWS:
cortical screws HA 2.7



Dlaha žlábková poloviční 1/2 tubular plate

SSt	A	otvorů holes
397 129 78 1160	71 mm	4
397 129 78 1170	87 mm	5
397 129 78 1180	103 mm	6
397 129 78 1190	119 mm	7
397 129 78 1200	135 mm	8
397 129 78 1210	151 mm	9
397 129 78 1220	167 mm	10

síla dlahy	plate thickness	1,0 mm
vzdálenost otvorů	distance of holes	16 mm

ŠROUBY:
kortikální šrouby HA 4,5

SCREWS:
cortical screws HA 4.5

Dlaha žlábková třetinová 1/3 tubular plate

SSt	A	otvorů holes
397 129 78 1090	49 mm	4
397 129 78 1100	61 mm	5
397 129 78 1110	73 mm	6
397 129 78 1120	85 mm	7
397 129 78 1130	97 mm	8

síla dlahy	plate thickness	1,0 mm
vzdálenost otvorů	distance of holes	12 mm

ŠROUBY:
kortikální šrouby HA 3,5
spongiozní šrouby HB 4

SCREWS:
cortical screws HA 3.5
cancellous screws HB 4

Dlaha žlábková čtvrtinová 1/4 tubular plate

SSt	A	otvorů holes
397 129 77 0940	23 mm	3
397 129 77 0950	31 mm	4
397 129 77 0960	39 mm	5
397 129 77 0970	47 mm	6
397 129 77 0980	55 mm	7
397 129 77 0990	63 mm	8

síla dlahy	plate thickness	1,0 mm
vzdálenost otvorů	distance of holes	8 mm

ŠROUBY:
kortikální šrouby HA 2,7

SCREWS:
cortical screws HA 2.7

Dlaha pánevní přímá
Pelvic plate straight

SSt	A	otvorů holes
397 129 78 9300	58 mm	5
397 129 78 9310	82 mm	7
397 129 78 9320	106 mm	9
397 129 78 9330	130 mm	11
397 129 78 9340	154 mm	13
397 129 78 9350	178 mm	15
397 129 78 9360	202 mm	17
397 129 78 9370	226 mm	19

síla dlahy plate thickness 2,8 mm

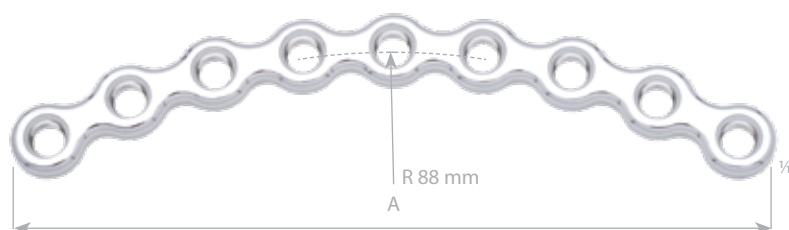
Dlaha pánevní zahnutá, R88
Pelvic plate curved, R88

SSt	A	otvorů holes
397 129 78 9400	100 mm	9
397 129 78 9410	130 mm	13
397 129 78 9420	153,7 mm	15
397 129 78 9430	166,3 mm	17
397 129 78 9440	176 mm	19

síla dlahy plate thickness 2,8 mm

 ŠROUBY:
kortikální šrouby HA 3,5
spongiozní šrouby HB 4

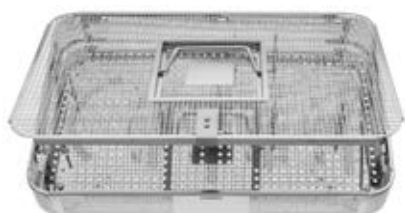
 SCREWS:
cortical screws HA 3.5
cancellous screws HB 4

397 129 69 9200 Síto na dlahy pánevní
400 × 240 × 50 mm
bez implantátů

 Sieve for pelvic plates
400 × 240 × 50 mm
without implants

 Pro uložení dlah pánevních přímých, dlah pánevních zahnutých a dlah OMEGA.
For keeping of pelvic plate straight, pelvic plate curved and OMEGA plates.

397 129 69 8650 Stojánek na šrouby pro dlahy OMEGA
160 × 125 × 81 mm
bez implantátů

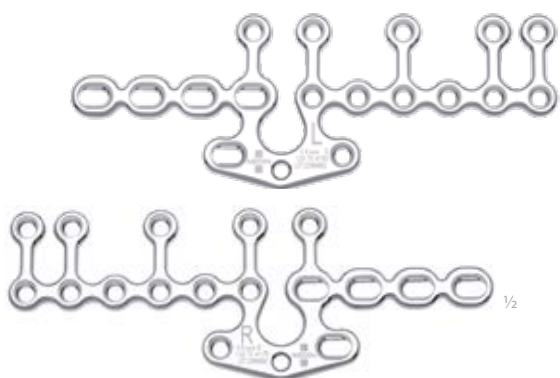
 Stand for screws for OMEGA plates
160 × 125 × 81 mm
excluding implants

DLAHY PÁNEVNÍ OMEGA
OMEGA PELVIC PLATESDlaha pánevní OMEGA základní
OMEGA basic pelvic plate

SSt	typ	type	A
397 129 70 4160	levá	left	129 × 48 mm
397 129 70 4170	pravá	right	129 × 48 mm

síla dlahy	plate thickness	2,8 mm
------------	-----------------	--------

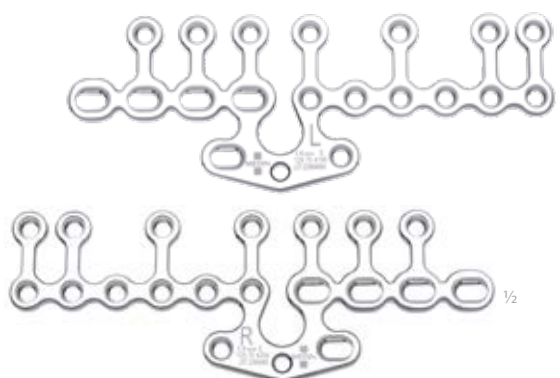
Dlaha pánevní OMEGA ILIAC
OMEGA ILIAC pelvic plate

SSt	typ	type	A
397 129 70 4190	levá	left	129 × 48 mm
397 129 70 4200	pravá	right	129 × 48 mm

síla dlahy	plate thickness	2,8 mm
------------	-----------------	--------

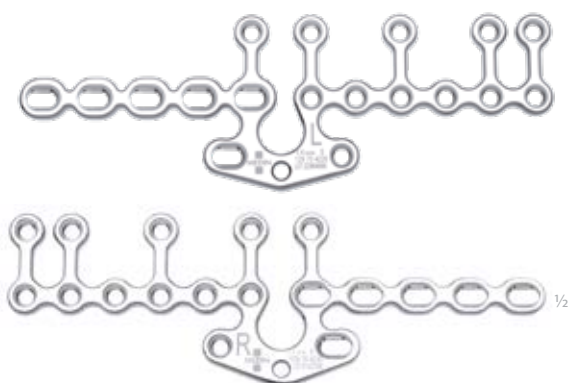
Dlaha pánevní OMEGA LONG
OMEGA LONG pelvic plate

SSt	typ	type	A
397 129 70 4220	levá	left	143 × 48 mm
397 129 70 4230	pravá	right	143 × 48 mm

síla dlahy	plate thickness	2,8 mm
------------	-----------------	--------

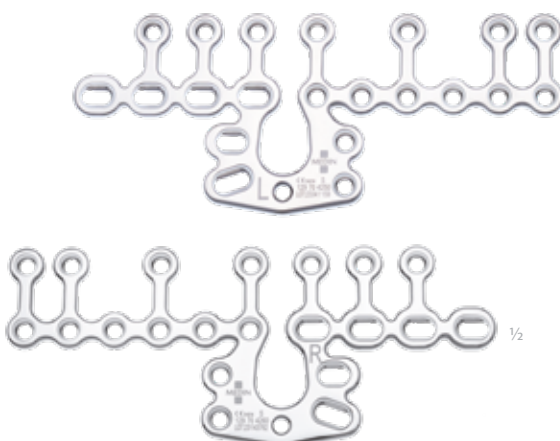
Dlaha pánevní OMEGA MAXI
OMEGA MAXI pelvic plate

SSt	typ	type	A
397 129 70 4250	levá	left	129 × 62 mm
397 129 70 4260	pravá	right	129 × 62 mm

síla dlahy	plate thickness	2,8 mm
------------	-----------------	--------

ŠROUBY:
kortikální šrouby HA 3,5
spongiozní šrouby HB 4

SCREWS:
cortical screws HA 3.5
cancellous screws HB 4

INSTRUMENTÁRIUM PRO DLAHY PÁNEVNÍ OMEGA
INSTRUMENTS FOR OMEGA PELVIC PLATES



397 139 09 0695 Set instrumentaria pro pánevní dlahy se sítím
540 × 240 × 90 mm
včetně nástrojů

Set of instrumentation for pelvic plates with a sieve
540 × 240 × 90 mm
including instruments



397 139 09 0690

soubor

set

1	397 129 69 5800	Šroubovák; šestihran 2,5 mm
2	397 129 69 6270	Páka ohýbací čepová
3	397 129 69 6291	Vrták 2,7 × 230 mm
4	397 129 69 8440	Páka ohýbací štěrbinová
5	397 129 69 8450	Bodec
6	397 129 69 8610	Hák na kyčel
7	397 129 69 8620	Páska
8	397 129 69 8630	Páka štěrbinová zahnutá
9	397 129 69 8640	Pouzdro vrtací
10	397 129 69 8910	Vrták 2,7 × 110 mm
11	397 129 69 9070	Páka ohýbací čepová
12	397 129 79 8900	Hloubkoměr

Screwdriver; hexagon 2.5 mm	ks/pcs	1
Bender, pin-type		1
Drill 2.7 × 230 mm		1
Bender, fissure-type		2
Spike		2
Hip hook		1
Tape		1
Curved lever, fissure -type		1
Protecting sleeve		1
Drill 2,7 × 110 mm		1
Bender, pin-type		1
Depth gauge		1

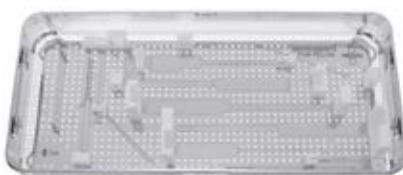

397 129 69 8660 Síto na instrumentárium pro pánevní dlahy
540 × 240 × 90 mm
bez nástrojů

Sieve for pelvic plates instrumentation
540 × 240 × 90 mm
without instruments

**Ohýbačka klešťová**
Plier**397 129 08 4960** 290 mm*pro šířku dlahy 11 mm*
for plates width 11 mm**HERCULES**
Kleště štípací na drát
Wire cutting forceps**397 116 91 0539** 230 mm*pro drát do průměru 3,0 mm*
for wires up to 3.0 mm in diameter



E

HŘEBY NAILS





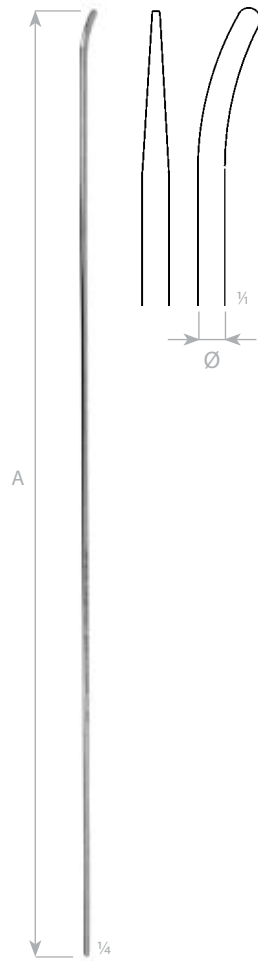



Hřeby elastické Hřeby elastické	Elastic nails Elastic nails	E.1 1–2
Hřeby femorální Hřeby femorální Implantáty pro hřeby femorální Instrumentárium pro hřeby nitrodřeňové	Femoral nails Femoral nails Implants for femoral nails Instruments for intramedullary nails	E.3 1 1–2 3–4
Hřeby femorální retrográdní Hřeby femorální retrográdní Implantáty pro hřeby femorální retrográdní Instrumentárium pro hřeby femorální retrográdní	Retrograde femoral nails Retrograde femoral nails Implants for retrograde femoral nails Instruments for retrograde femoral nails	E.4 1 2 3
Hřeby rekonstrukční Hřeby rekonstrukční Hřeby rekonstrukční krátké Implantáty pro hřeby rekonstrukční Instrumentárium pro hřeby rekonstrukční	Reconstruction nails Reconstruction nails Short reconstruction nails Implants for reconstruction nails Instruments for reconstruction nails	E.5 1–2 3–4 5–6 7–9
Hřeby tibiální Hřeby tibiální Implantáty pro hřeby tibiální Instrumentárium pro hřeby nitrodřeňové	Tibial nails Tibial nails Implants for tibial nails Instruments for intramedullary nails	E.6 1–2 3–4 5–6
Hřeby tibiální proximální Hřeby tibiální proximální Implantáty pro hřeby tibiální proximální Instrumentárium pro hřeby tibiální proximální	Proximal tibial nails Proximal tibial nails Implants for proximal tibial nails Instruments for proximal tibial nails	E.7 1–2 3–4 5–6
C-NAIL hřeby patní C-NAIL hřeby patní Implantáty C-NAIL hřeby patní Instrumentárium pro C-NAIL hřeby patní	C-NAIL calcaneal nails C-NAIL calcaneal nails Implants for C-NAIL calcaneal nails Instruments for C-NAIL calcaneal nails	E.8 1 1 2
Hřeby humerální Hřeby humerální Implantáty pro hřeby humerální Instrumentárium pro hřeby humerální	Humeral nails Humeral nails Implants for humeral nails Instruments for humeral nails	E.9 1 2 3–4
Hřeby humerální krátké a dlouhé Hřeby humerální krátké Hřeby humerální dlouhé Implantáty pro hřeby humerální krátké a dlouhé Instrumentárium pro hřeby humerální krátké a dlouhé	Short and long humeral nails Short humeral nails Long humeral nails Implants for short and long humeral nails Instruments for short and long humeral nails	E.10 1 2 3 4–5
Nástroje pro hřeby Instrumentárium pro extrakci hřebů Instrumentárium pro extrakci šroubů	Instruments for nails Instruments for nails extraction Instruments for screws extraction	E.11 1 2

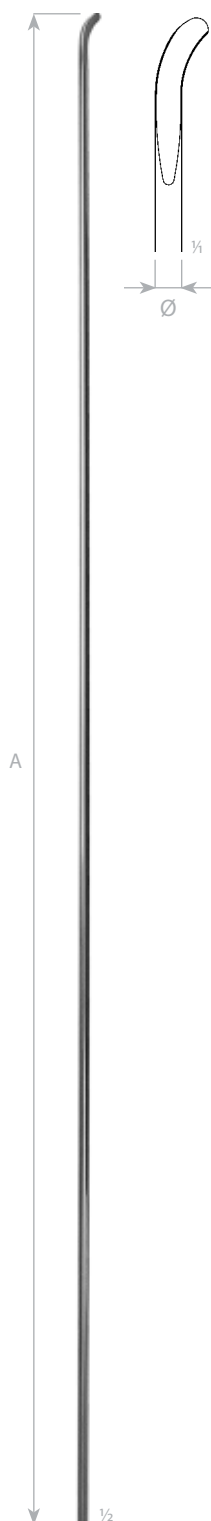

Hřeb elastický
Elastic nail

SSt	A	Ø
397 129 09 6460	500 mm	2,5 mm
397 129 09 6470	500 mm	3,0 mm
397 129 09 6480	500 mm	3,5 mm

Hřeb elastický
Elastic nail

	Ti	A	Ø	barva	colour
	397 129 77 5313	400 mm	2,0 mm	světle modrá	light blue
	397 129 99 1266	440 mm	2,0 mm	světle modrá	light blue
	397 129 77 5323	400 mm	2,5 mm	zelená	green
	397 129 99 1267	440 mm	2,5 mm	zelená	green
	397 129 99 1268	440 mm	3,0 mm	žlutá	yellow
	397 129 77 5333	450 mm	3,0 mm	žlutá	yellow
	397 129 99 1269	440 mm	3,5 mm	modrá	blue
	397 129 77 5343	450 mm	3,5 mm	modrá	blue
	397 129 99 1270	440 mm	4,0 mm	fialová	purple
	397 129 77 5353	450 mm	4,0 mm	fialová	purple
	397 129 77 5363	500 mm	4,0 mm	fialová	purple

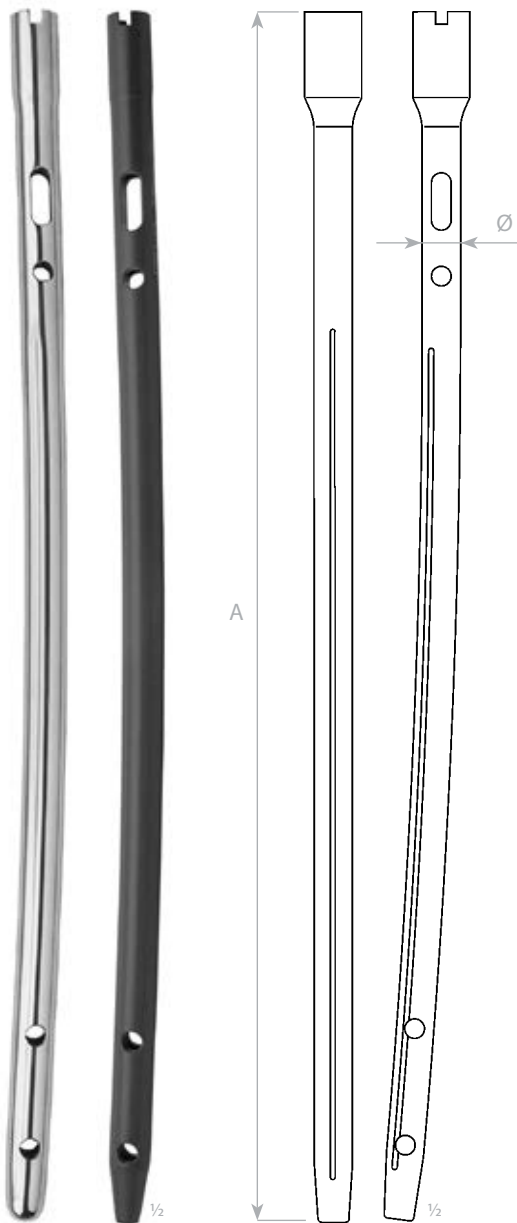
Hřeb femorální
 Femoral nail

SSt	Ti	A	Ø
397 129 79 2700	397 129 79 2703	320 mm	10 mm
397 129 79 2710	397 129 79 2713	340 mm	10 mm
397 129 79 2720	397 129 79 2723	360 mm	10 mm
397 129 79 2730	397 129 79 2733	380 mm	10 mm
397 129 79 2740	397 129 79 2743	400 mm	10 mm
397 129 79 2750	397 129 79 2753	420 mm	10 mm
397 129 79 2760	397 129 79 2763	440 mm	10 mm
397 129 79 2770	397 129 79 2773	460 mm	10 mm
397 129 79 2780	397 129 79 2783	480 mm	10 mm
397 129 79 2800	397 129 79 2803	320 mm	11 mm
397 129 79 2810	397 129 79 2813	340 mm	11 mm
397 129 79 2820	397 129 79 2823	360 mm	11 mm
397 129 79 2830	397 129 79 2833	380 mm	11 mm
397 129 79 2840	397 129 79 2843	400 mm	11 mm
397 129 79 2850	397 129 79 2853	420 mm	11 mm
397 129 79 2860	397 129 79 2863	440 mm	11 mm
397 129 79 2870	397 129 79 2873	460 mm	11 mm
397 129 79 2880	397 129 79 2883	480 mm	11 mm
397 129 79 2900	397 129 79 2903	320 mm	12 mm
397 129 79 2910	397 129 79 2913	340 mm	12 mm
397 129 79 2920	397 129 79 2923	360 mm	12 mm
397 129 79 2930	397 129 79 2933	380 mm	12 mm
397 129 79 2940	397 129 79 2943	400 mm	12 mm
397 129 79 2950	397 129 79 2953	420 mm	12 mm
397 129 79 2960	397 129 79 2963	440 mm	12 mm
397 129 79 2970	397 129 79 2973	460 mm	12 mm
397 129 79 2980	397 129 79 2983	480 mm	12 mm
397 129 79 2990		320 mm	13 mm
397 129 79 3000		340 mm	13 mm
397 129 79 3010		360 mm	13 mm
397 129 79 3020		380 mm	13 mm
397 129 79 3030		400 mm	13 mm
397 129 79 3040		420 mm	13 mm
397 129 79 3050		440 mm	13 mm
397 129 79 3060		460 mm	13 mm
397 129 79 3070		480 mm	13 mm
397 129 79 3080		500 mm	13 mm
397 129 79 3100		360 mm	14 mm
397 129 79 3110		380 mm	14 mm
397 129 79 3120		400 mm	14 mm
397 129 79 3130		420 mm	14 mm
397 129 79 3140		440 mm	14 mm
397 129 79 3150		460 mm	14 mm
397 129 79 3160		480 mm	14 mm

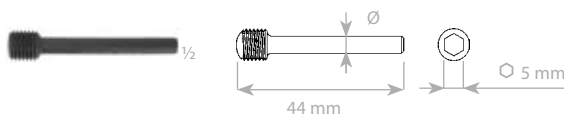
Šroub kompresní
 Compression screw

SSt	Ti	Ø
397 129 79 1810	397 129 79 1813	4,4 mm

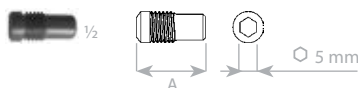
Zátka
 End cap

SSt	Ti	A
397 129 77 1610	397 129 77 1613	18 mm
397 129 77 1970	397 129 77 1973	23 mm
397 129 77 1980	397 129 77 1983	28 mm

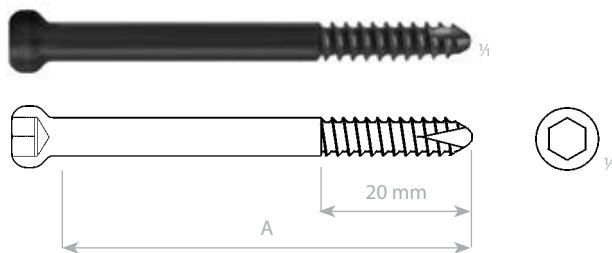
IMPLANTÁTY PRO HŘEBY FEMORÁLNÍ
IMPLANTS FOR FEMORAL NAILS

průměr závitu	thread diameter	5,0 mm
průměr díku	shank diameter	5,0 mm
průměr jádra	core diameter	3,5 mm
průměr hlavy	head diameter	8,0 mm
vrták pro závit	drill bit for threaded hole	Ø 3,5 mm
vrták pro kluzný otvor	drill bit for gliding hole	Ø 5,0 mm
šroubovák	screwdriver	Ø 5,0 mm

Šroub zajišťovací 5 mm, závit 20 mm
Locking screw 5 mm, thread 20 mm

SSt	Ti	A
397 129 79 1500	397 129 79 1503	25 mm
397 129 79 1520	397 129 79 1523	30 mm
397 129 79 1540	397 129 79 1543	35 mm
397 129 79 1560	397 129 79 1563	40 mm
397 129 79 1580	397 129 79 1583	45 mm
397 129 79 1600	397 129 79 1603	50 mm
397 129 79 1620	397 129 79 1623	55 mm
397 129 79 1640	397 129 79 1643	60 mm
397 129 79 1660	397 129 79 1663	65 mm
397 129 79 1680	397 129 79 1683	70 mm
397 129 79 1700	397 129 79 1703	75 mm
397 129 79 1720	397 129 79 1723	80 mm
397 129 79 1740	397 129 79 1743	85 mm
397 129 79 1760	397 129 79 1763	90 mm

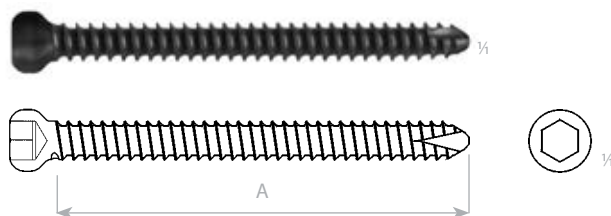

průměr závitu	thread diameter	5,0 mm
průměr jádra	core diameter	3,5 mm
průměr hlavy	head diameter	8,0 mm
vrták pro závit	drill bit for threaded hole	Ø 3,5 mm
vrták pro kluzný otvor	drill bit for gliding hole	Ø 5,0 mm
šroubovák	screwdriver	Ø 5,0 mm

Šroub zajišťovací 5 mm, plný závit
Locking screw 5 mm, fully threaded

SSt	Ti	A
397 129 79 1510	397 129 79 1513	25 mm
397 129 79 1530	397 129 79 1533	30 mm
397 129 79 1550	397 129 79 1553	35 mm
397 129 79 1570	397 129 79 1573	40 mm
397 129 79 1590	397 129 79 1593	45 mm
397 129 79 1610	397 129 79 1613	50 mm
397 129 79 1630	397 129 79 1633	55 mm
397 129 79 1650	397 129 79 1653	60 mm
397 129 79 1670	397 129 79 1673	65 mm
397 129 79 1690	397 129 79 1693	70 mm
397 129 79 1710	397 129 79 1713	75 mm
397 129 79 1730	397 129 79 1733	80 mm
397 129 79 1750	397 129 79 1753	85 mm
397 129 79 1770	397 129 79 1773	90 mm
397 129 79 1290	397 129 79 1293	95 mm
397 129 79 1300	397 129 79 1303	100 mm
397 129 79 1310	397 129 79 1313	105 mm

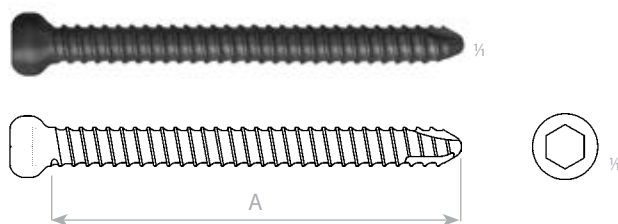

průměr závitu	thread diameter	5,0 mm
průměr jádra	core diameter	4,4 mm
průměr hlavy	head diameter	8,0 mm
vrták pro závit	drill bit for threaded hole	Ø 4,4 mm
vrták pro kluzný otvor	drill bit for gliding hole	Ø 5,0 mm
šroubovák	screwdriver	Ø 5,0 mm

Šroub zajišťovací zesílený 5 mm
Locking screw strengthened 5 mm

SSt	Ti	A
397 129 79 9631	397 129 79 9634	25 mm
397 129 79 9641	397 129 79 9644	30 mm
397 129 79 9651	397 129 79 9654	35 mm
397 129 79 9661	397 129 79 9664	40 mm
397 129 79 9671	397 129 79 9674	45 mm
397 129 79 9681	397 129 79 9684	50 mm
397 129 79 9691	397 129 79 9694	55 mm
397 129 79 9701	397 129 79 9704	60 mm
397 129 79 9711	397 129 79 9714	65 mm
397 129 79 9721	397 129 79 9724	70 mm
397 129 79 9731	397 129 79 9734	75 mm
397 129 79 9741	397 129 79 9744	80 mm
397 129 79 9751	397 129 79 9754	85 mm
397 129 79 9761	397 129 79 9764	90 mm

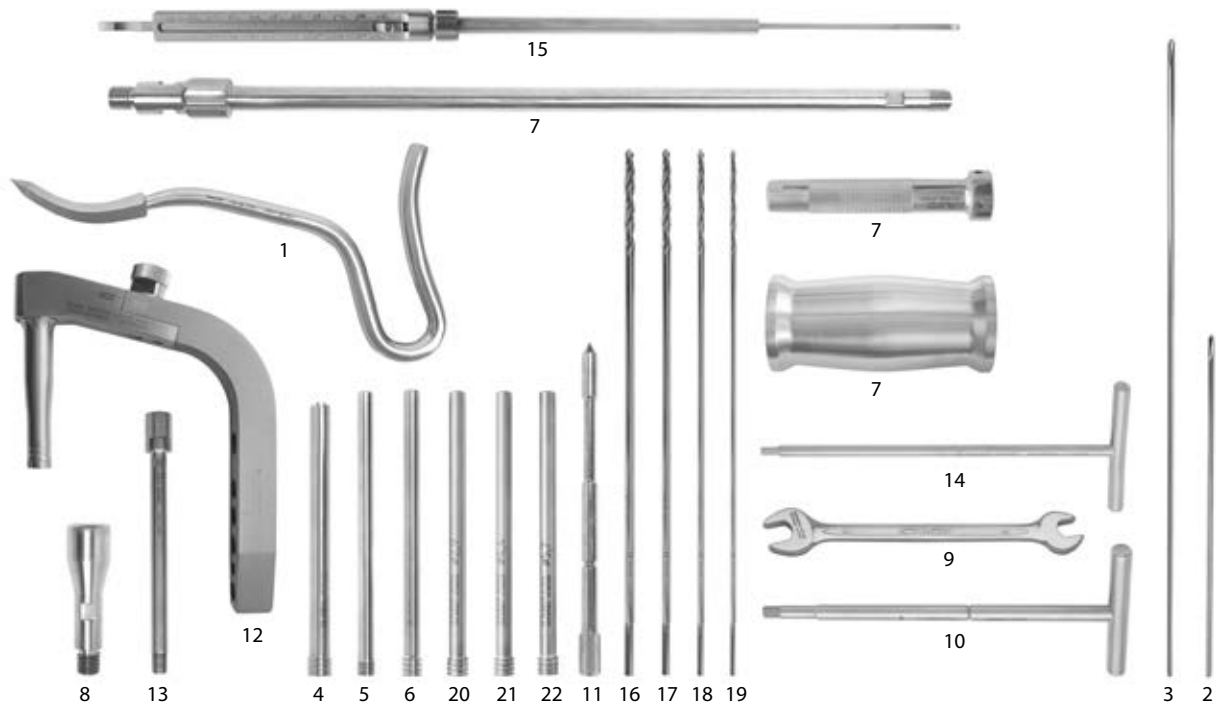
INSTRUMENTÁRIUM PRO HŘEBY NITRODŘEŇOVÉ
INSTRUMENTS FOR INTRAMEDULLARY NAILS

Instrumentárium pro zavádění nitrodřeňových hřebů
Instruments for introducing of intramedullary nails

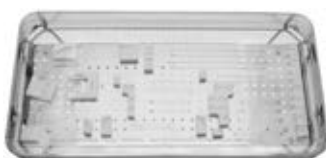
	soubor	set	ks / pcs
1	397 129 09 0700 Perforátor zahnutý; 12×195 mm	Perforator curved; 12×195 mm	1
2	397 129 09 2510 K-drát MEDIN 2,5×160 mm	MEDIN K-wire 2.5×160 mm	1
3	397 129 09 2590 K-drát MEDIN 2,5×300 mm	MEDIN K-wire 2.5×300 mm	1
4	397 129 69 1190 Pouzdro 2; 10/8 mm; 130 mm	Sleeve 2; 10/8 mm; 130 mm	1
5	397 129 69 1200 Pouzdro 3; 8/5 mm; 135 mm	Sleeve 3; 8/5 mm; 135 mm	1
6	397 129 69 1210 Pouzdro 4; 8/3,5 mm; 135 mm	Sleeve 4; 8/3.5 mm; 135 mm	1
7	397 129 69 1600 Kladiivo	Mallet	1
8	397 129 69 1620 Naražeč M12; 74 mm	Impactor; 74 mm	1
9	397 129 69 1630 Klíč 10/12; 130 mm	Wrench 10/12; 130 mm	1
10	397 129 69 1640 Šroubovák T; 5×175 mm	Screwdriver T; 5×175 mm	1
11	397 129 69 1650 Důlčik 7,9×158 mm	Trocar 7.9×158 mm	1
12	397 129 69 2590 Cíliče pro nitrodřeňový hřeb	Aiming device for intramedullary nails	1
13	397 129 69 2830 Šroub cíliče	Screw of aiming device	1
14	397 129 69 4050 Šroubovák T kanylovaný 3,5/1,8×175 mm; šestihran	Cannulated screwdriver T hexagonal; 3.5/1.8×175 mm	1
15	397 129 79 2111 Hloubkoměr	Depth gauge	1
16	397 129 79 4980 Vrták; 5×250 mm	Drill; 5.0×250 mm	1
17	397 129 79 4990 Vrták; 3,5×250 mm	Drill; 3.5×250 mm	2
18	397 129 79 8430 Vrták; 4,4×250 mm	Drill; 4.4×250 mm	1
19	397 129 79 8440 Vrták; 2,9×250 mm	Drill; 2.9×250 mm	1
20	397 129 79 8450 Pouzdro; 8/2,9 mm; 135 mm	Sleeve; 8/2.9 mm; 135 mm	1
21	397 129 79 8460 Pouzdro; 8/4,4 mm; 135 mm	Sleeve; 8/4.4 mm; 135 mm	1
22	397 129 79 8470 Pouzdro; 8/5,7 mm; 135 mm	Sleeve; 8/5.7 mm; 135 mm	1

Síta na instrumentárium
Sieves for instruments

397 129 69 4530 Síto na instrumentárium pro hřebí nitrodřeňové Fig. 1; 480 × 240 × 50 mm

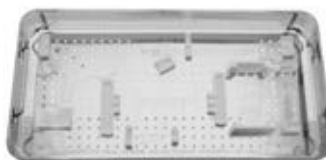
Sieve for instruments for intramedullary nails Fig. 1; 480 × 240 × 50 mm



397 129 69 4540 Síto na instrumentárium pro hřebí nitrodřeňové Fig. 2; 480 × 240 × 70 mm

Sieve for instruments for intramedullary nails Fig. 2; 480 × 240 × 70 mm

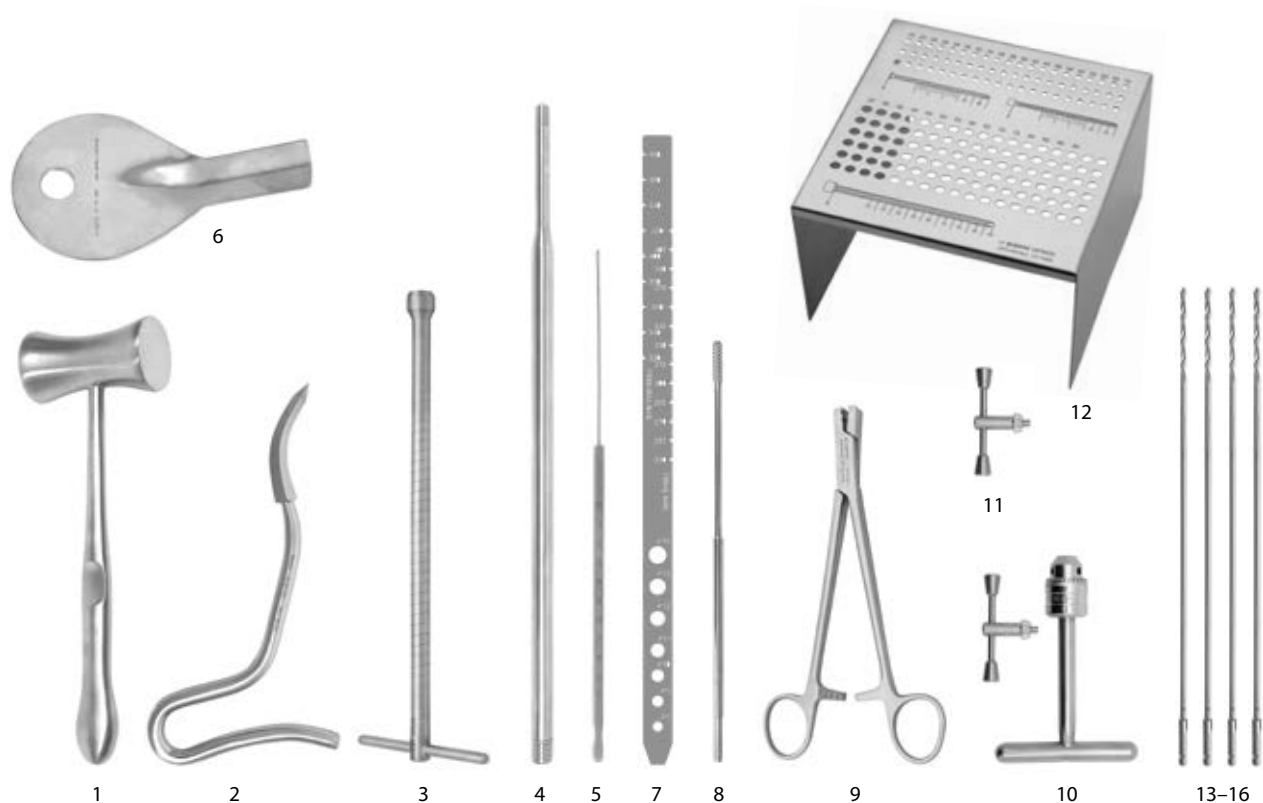
**Doplňkové nástroje**

Supplementary instruments

1	397 128 08 0921	Kladivo chirurgické kovové 700 g	Mallet metallic 700 g
2	397 129 09 0710	Perforátor zahnutý; 10×195 mm	Perforator curved; 10×195 mm
3	397 129 69 1220	Klíč flexibilní 12×250 mm; šestihran	Flexible wrench; 12×250 mm
4	397 129 69 1610	Tyč vytahovací M8/M12; 350 mm	Bar M8/M12; 350 mm
5	397 129 69 2140	Hloubkoměr; 270 mm	Depth gauge; 270 mm
6	397 129 79 1990	Chránič 86×157 mm	Skin protector 86×157 mm
7	397 129 79 2120	Měřítko RTG kontrastní; 495 mm	RTG rule; 495 mm
8	397 129 79 3500	Závitník 1, 220 mm	Tap 1; 220 mm
9	397 129 79 3610	Svorka na zavaděč nitrodřeňového hřebu; 187 mm	Holding forceps for introducing wires; 187 mm
10	397 129 79 3990	Sklíčidlo ruční, komplet	Hand chuck; complete
11	397 129 79 4020	Klíčka ručního sklíčidla	Chuck key
12	397 129 79 4030	Stojánek pro zajišťovací šrouby	Stand for locking screws
13	397 129 79 4981	Vrták; Ø5×250 mm; bílá	Drill; Ø5×250 mm; white
14	397 129 79 4991	Vrták; Ø3,5×250 mm; žlutá	Drill; Ø3.5×250 mm; yellow
15	397 129 79 8431	Vrták; Ø4,4×250 mm; červená	Drill; Ø4.4×250 mm; red
16	397 129 79 8441	Vrták; Ø2,9×250 mm; zelená	Drill; Ø2.9×250 mm; green

Hřeb femorální retrográdní
Retrograde femoral nail

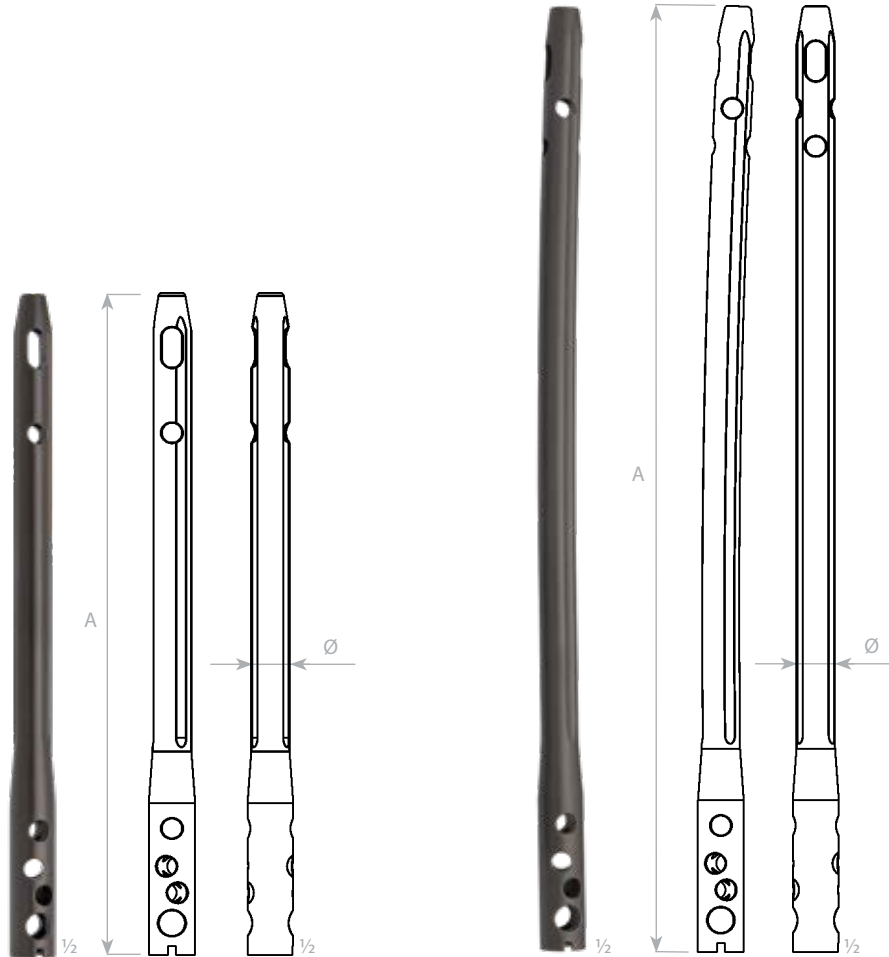

Ti	A	Ø
397 129 78 6793	175 mm	10 mm
397 129 78 6803	200 mm	10 mm
397 129 78 6843	175 mm	12 mm
397 129 78 6853	200 mm	12 mm

Ti	A	Ø
397 129 78 6813	250 mm	10 mm
397 129 78 6823	300 mm	10 mm
397 129 78 6833	350 mm	10 mm
397 129 78 6863	250 mm	12 mm
397 129 78 6873	300 mm	12 mm
397 129 78 6883	350 mm	12 mm

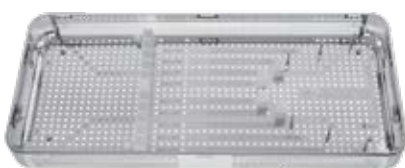

397 129 69 7090 Síto na hřeb femorální retrográdní
540 × 240 × 50 mm
bez implantátů

Sieve for retrograde femoral nails
540 × 240 × 50 mm
excluding implants

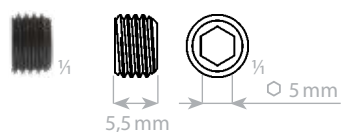
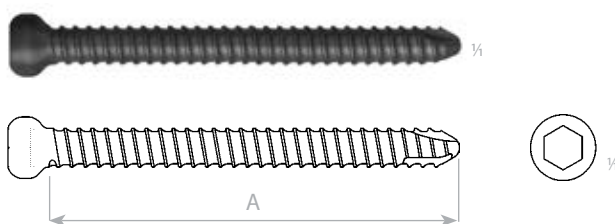
IMPLANTÁTY PRO HŘEBY FEMORÁLNÍ RETROGRÁDNÍ
IMPLANTS FOR RETROGRADE FEMORAL NAILS**Zátka**
End capTi
397 129 78 4143

průměr závitu	thread diameter	5,0 mm
průměr jádra	core diameter	4,4 mm
průměr hlavy	head diameter	8,0 mm
vrták pro závit	drill bit for threaded hole	Ø 4,4 mm
vrták pro kluzný otvor	drill bit for gliding hole	Ø 5,0 mm
šroubovák	screwdriver	Ø 5,0 mm

Šroub zajišťovací zesílený 5 mm
Locking screw strengthened 5 mm

Ti	A
397 129 79 9634	25 mm
397 129 79 9644	30 mm
397 129 79 9654	35 mm
397 129 79 9664	40 mm
397 129 79 9674	45 mm
397 129 79 9684	50 mm
397 129 79 9694	55 mm
397 129 79 9704	60 mm
397 129 79 9714	65 mm
397 129 79 9724	70 mm
397 129 79 9734	75 mm
397 129 79 9744	80 mm
397 129 79 9754	85 mm
397 129 79 9764	90 mm

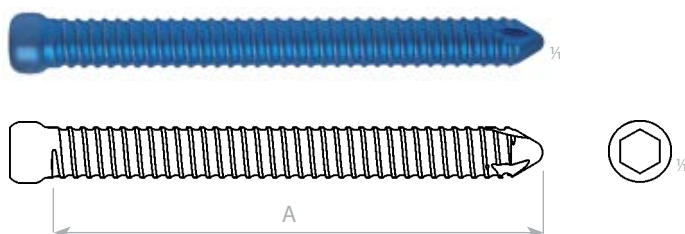

průměr závitu	thread diameter	6,5 mm
průměr jádra	core diameter	5,9 mm
průměr hlavy	head diameter	8,0 mm
vrták pro závit	drill bit for threaded hole	Ø 4,4 mm
šroubovák	screwdriver	Ø 5 mm

Šroub zajišťovací 6,5 mm
Locking screw 6.5 mm

Ti	A
397 129 70 9274	40 mm
397 129 70 9284	45 mm
397 129 70 9294	50 mm
397 129 70 9304	55 mm
397 129 78 9154	60 mm
397 129 78 9164	65 mm
397 129 78 9174	70 mm
397 129 78 9184	75 mm
397 129 78 9194	80 mm
397 129 78 9204	85 mm
397 129 78 9214	90 mm
397 129 78 9224	95 mm
397 129 78 9234	100 mm
397 129 78 9244	105 mm
397 129 78 9254	110 mm
397 129 78 9264	115 mm
397 129 78 9274	120 mm

**397 129 69 7900** Stojánek na zajišťovací šrouby pro
hřeb femorální retrográdní
180 × 146 × 136 mm
bez implantátůStand for locking crews for retrograde
femoral nails
180 × 146 × 136 mm
excluding implants

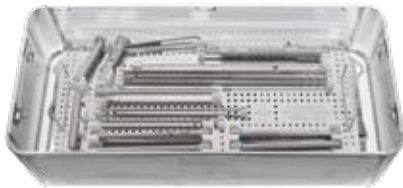
INSTRUMENTÁRIUM PRO HŘEBY FEMORÁLNÍ RETROGRÁDNÍ
 INSTRUMENTS FOR RETROGRADE FEMORAL NAILS

397 139 09 0575 Set instrumentů pro hřeby femorální retrográdní
 540 × 240 × 130 mm
 včetně nástrojů

 Set of instruments for retrograde femoral nails
 540 × 240 × 130 mm
 including instruments

397 139 09 0570

soubor

set

1	397 129 09 0702	Perforátor zahnutý 12 mm
2	397 129 69 5890	Cílič pro hřeby femorální retrográdní
3	397 129 69 6100	Tyč dotahovací
4	397 129 69 6400	Pouzdro 10/8×155 mm
5	397 129 69 6420	Pouzdro 8/3,5×171 mm
6	397 129 69 6430	Pouzdro 8/4,4×171 mm
7	397 129 69 6470	Trokar 8×182 mm
8	397 129 69 6631	Vrták 3,5×320 mm
9	397 129 69 6641	Vrták 4,4×320 mm
10	397 129 69 7210	Ucpávka 10×30 mm
11	397 129 69 7340	Fréza Ø 13 / Ø 3 mm
12	397 129 69 7350	Pouzdro frézovací Ø 13 mm
13	397 129 69 7360	K-drát s olivkou Ø 3×300 mm
14	397 129 69 7370	Pouzdro pro drát Ø 13 / Ø 3 mm
15	397 129 69 7380	T-šroubovák šestihran 5 mm
16	397 129 69 8040	Hloubkoměr
17	397 129 69 9060	Šroubovák šestihran 5 mm
18	397 129 69 9080	Cílič kostka pro staré hřeby
19	397 129 69 9090	Upínací čep pro staré hřeby
20	397 129 69 9160	Pouzdro Ø 8 / Ø 5,5×171 mm
21	397 129 69 9170	Vrták Ø 5,5×320 mm

		Perforator curved 12 mm	ks/pcs
		Aiming device for retrograde femoral nails	1
		Wrench rod	1
		Sleeve 10/8×155 mm	4
		Sleeve 8/3.5×171 mm	1
		Sleeve 8/4.4×171 mm	2
		Trocar 8×182 mm	1
		Drill 3.5×320 mm	1
		Drill 4.4×320 mm	2
		Plug 10×30 mm	4
		Cutter Ø 13 / Ø 3 mm	1
		Cutting sleeve Ø13 mm	1
		K-wire with olive Ø 3×300 mm	1
		Sleeve for wire Ø 13 / Ø 3 mm	1
		T-screwdriver; hexagonal 5 mm	1
		Depth gauge	1
		Screwdriver; hexagonal 5 mm	1
		Aiming crossbar for old nails	1
		Coupling pin for old nails	1
		Sleeve Ø 8 / Ø 5.5×171 mm	1
		Drill Ø 5.5×320 mm	1

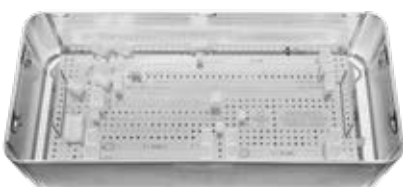
397 129 69 7070 Síto na instrumentárium pro hřeby femorální retrográdní
 540 × 240 × 130 mm
 bez nástrojů

 Sieve for instruments for retrograde femoral nails
 540 × 240 × 130 mm
 excluding instruments

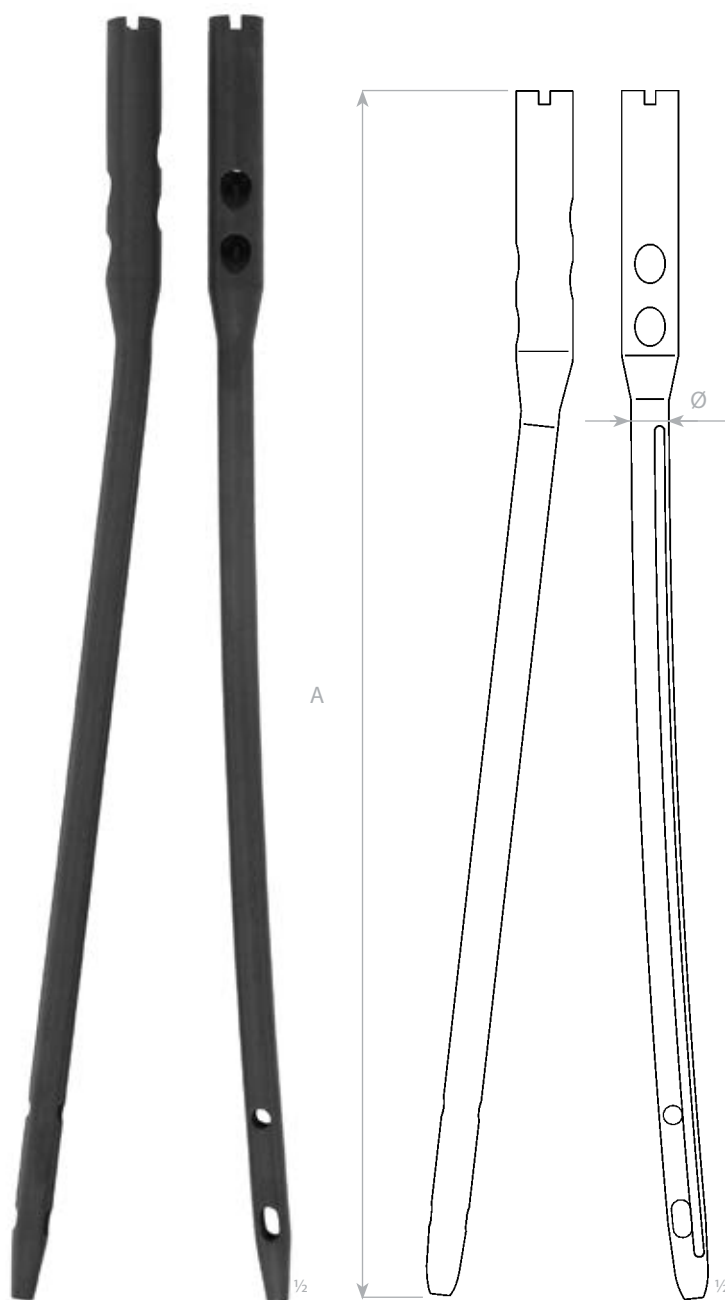
Hřeb rekonstrukční levý, kanylový
 Reconstruction nail, left, cannulated

SSt	Ti	A	Ø
397 129 79 0041	397 129 79 0043	320 mm	10 mm
397 129 79 0061	397 129 79 0063	340 mm	10 mm
397 129 79 0081	397 129 79 0083	360 mm	10 mm
397 129 79 0101	397 129 79 0103	380 mm	10 mm
397 129 79 0121	397 129 79 0123	400 mm	10 mm
397 129 79 0141	397 129 79 0143	420 mm	10 mm
397 129 79 0161	397 129 79 0163	440 mm	10 mm
397 129 79 0181	397 129 79 0183	460 mm	10 mm
397 129 79 0201	397 129 79 0203	480 mm	10 mm
397 129 79 0261	397 129 79 0263	320 mm	11 mm
397 129 79 0281	397 129 79 0283	340 mm	11 mm
397 129 79 0301	397 129 79 0303	360 mm	11 mm
397 129 79 0321	397 129 79 0323	380 mm	11 mm
397 129 79 0341	397 129 79 0343	400 mm	11 mm
397 129 79 0361	397 129 79 0363	420 mm	11 mm
397 129 79 0381	397 129 79 0383	440 mm	11 mm
397 129 79 0401	397 129 79 0403	460 mm	11 mm
397 129 79 0421	397 129 79 0423	480 mm	11 mm
397 129 79 0441	397 129 79 0443	500 mm	11 mm
397 129 79 0501	397 129 79 0503	320 mm	12 mm
397 129 79 0521	397 129 79 0523	340 mm	12 mm
397 129 79 0541	397 129 79 0543	360 mm	12 mm
397 129 79 0561	397 129 79 0563	380 mm	12 mm
397 129 79 0581	397 129 79 0583	400 mm	12 mm
397 129 79 0601	397 129 79 0603	420 mm	12 mm
397 129 79 0621	397 129 79 0623	440 mm	12 mm
397 129 79 0681		320 mm	13 mm
397 129 79 0701		340 mm	13 mm
397 129 79 0721		360 mm	13 mm
397 129 79 0741		380 mm	13 mm
397 129 79 0761		400 mm	13 mm
397 129 79 0781		420 mm	13 mm
397 129 79 0801		440 mm	13 mm
397 129 79 0821		460 mm	13 mm
397 129 79 0841		480 mm	13 mm
397 129 79 0861		500 mm	13 mm
397 129 79 0921		360 mm	14 mm
397 129 79 0941		380 mm	14 mm
397 129 79 0961		400 mm	14 mm
397 129 79 0981		420 mm	14 mm
397 129 79 1001		440 mm	14 mm

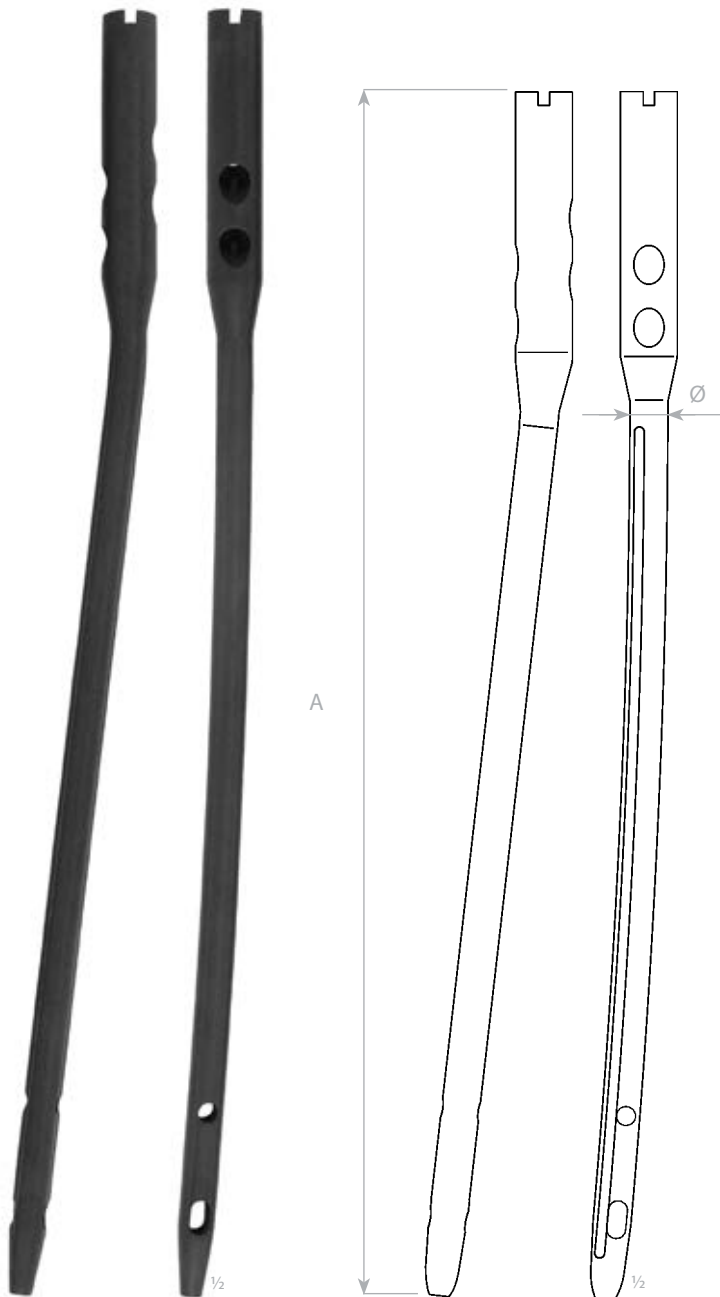
Hřeb rekonstrukční pravý, kanylovaný
Reconstruction nail, right, cannulated

SSt	Ti	A	Ø
397 129 79 0031	397 129 79 0033	320 mm	10 mm
397 129 79 0051	397 129 79 0053	340 mm	10 mm
397 129 79 0071	397 129 79 0073	360 mm	10 mm
397 129 79 0091	397 129 79 0093	380 mm	10 mm
397 129 79 0111	397 129 79 0113	400 mm	10 mm
397 129 79 0131	397 129 79 0133	420 mm	10 mm
397 129 79 0151	397 129 79 0153	440 mm	10 mm
397 129 79 0171	397 129 79 0173	460 mm	10 mm
397 129 79 0191	397 129 79 0193	480 mm	10 mm
397 129 79 0251	397 129 79 0253	320 mm	11 mm
397 129 79 0271	397 129 79 0273	340 mm	11 mm
397 129 79 0291	397 129 79 0293	360 mm	11 mm
397 129 79 0311	397 129 79 0313	380 mm	11 mm
397 129 79 0331	397 129 79 0333	400 mm	11 mm
397 129 79 0351	397 129 79 0353	420 mm	11 mm
397 129 79 0371	397 129 79 0373	440 mm	11 mm
397 129 79 0391	397 129 79 0393	460 mm	11 mm
397 129 79 0411	397 129 79 0413	480 mm	11 mm
397 129 79 0431	397 129 79 0433	500 mm	11 mm
397 129 79 0491	397 129 79 0493	320 mm	12 mm
397 129 79 0511	397 129 79 0513	340 mm	12 mm
397 129 79 0531	397 129 79 0533	360 mm	12 mm
397 129 79 0551	397 129 79 0553	380 mm	12 mm
397 129 79 0571	397 129 79 0573	400 mm	12 mm
397 129 79 0591	397 129 79 0593	420 mm	12 mm
397 129 79 0611	397 129 79 0613	440 mm	12 mm
397 129 79 0671		320 mm	13 mm
397 129 79 0691		340 mm	13 mm
397 129 79 0711		360 mm	13 mm
397 129 79 0731		380 mm	13 mm
397 129 79 0751		400 mm	13 mm
397 129 79 0771		420 mm	13 mm
397 129 79 0791		440 mm	13 mm
397 129 79 0811		460 mm	13 mm
397 129 79 0831		480 mm	13 mm
397 129 79 0851		500 mm	13 mm
397 129 79 0911		360 mm	14 mm
397 129 79 0931		380 mm	14 mm
397 129 79 0951		400 mm	14 mm
397 129 79 0971		420 mm	14 mm
397 129 79 0991		440 mm	14 mm

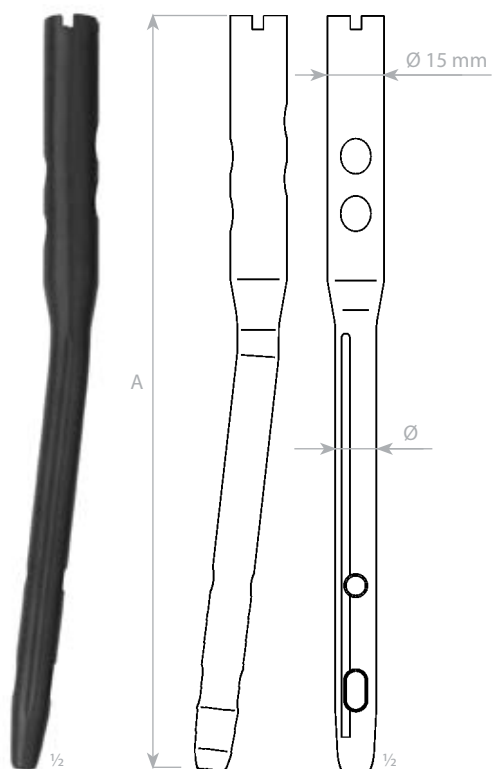
HŘEBY REKONSTRUKČNÍ KRÁTKÉ
SHORT RECONSTRUCTION NAILSHřeb rekonstrukční krátký, kanylový
Short reconstruction nail, cannulated

SSt	Ti	A	Ø	
397 129 77 1320	397 129 77 1323	200 mm	11 mm	130°
397 129 77 1330	397 129 77 1333	200 mm	11 mm	135°
397 129 77 1360	397 129 77 1363	200 mm	13 mm	130°
397 129 77 1370	397 129 77 1373	200 mm	13 mm	135°

na zvláštní objednávku – for special order

397 129 77 1310		200 mm	11 mm	125°
397 129 77 1350		200 mm	13 mm	125°

HŘEBY REKONSTRUKČNÍ KRÁTKÉ
SHORT RECONSTRUCTION NAILS

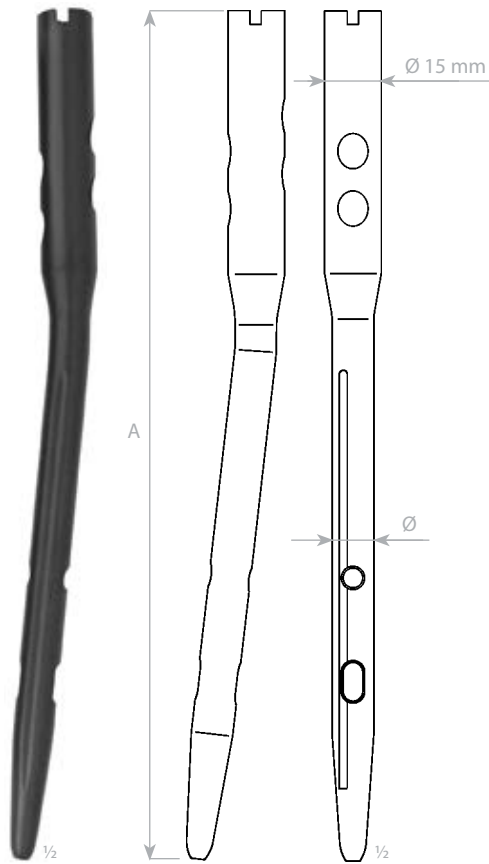

Hřeb rekonstrukční krátký, plný
Short reconstruction nail, full

	SSt	Ti	A	Ø	
397 129 77 2920		397 129 77 2923	225 mm	11 mm	130°
397 129 77 2930		397 129 77 2933	225 mm	11 mm	135°
397 129 77 2960		397 129 77 2963	225 mm	13 mm	130°
397 129 77 2970		397 129 77 2973	225 mm	13 mm	135°

na zvláštní objednávku – for special order

397 129 77 2910			225 mm	11 mm	125°
397 129 77 2950			225 mm	13 mm	125°

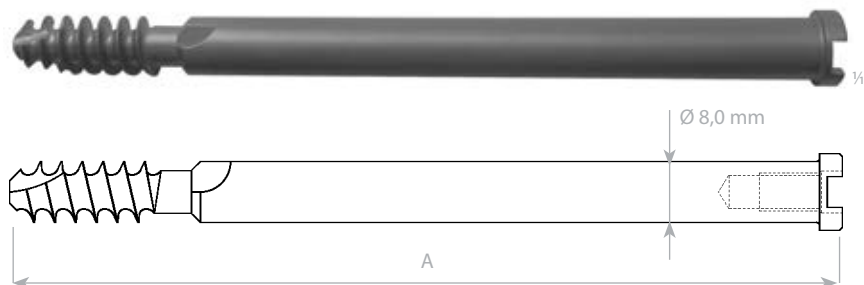
IMPLANTÁTY PRO HŘEBY REKONSTRUKČNÍ
IMPLANTS FOR RECONSTRUCTION NAILSŠroub
Screw

SSt	Ti	A
397 129 77 1390	397 129 77 1393	70 mm
397 129 77 1400	397 129 77 1403	75 mm
397 129 77 1410	397 129 77 1413	80 mm
397 129 77 1420	397 129 77 1423	85 mm
397 129 77 1430	397 129 77 1433	90 mm
397 129 77 1440	397 129 77 1443	95 mm
397 129 77 1450	397 129 77 1453	100 mm
397 129 77 1460	397 129 77 1463	105 mm
397 129 77 1470	397 129 77 1473	110 mm
397 129 77 1480	397 129 77 1483	115 mm
397 129 77 1490	397 129 77 1493	120 mm
397 129 77 1500	397 129 77 1503	125 mm
397 129 77 1510	397 129 77 1513	130 mm
397 129 77 1520	397 129 77 1523	135 mm

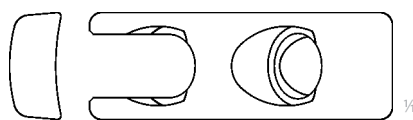
Dlaha
Plate

SSt	Ti	
397 129 77 1540	397 129 77 1543	40 × 14 × 6 mm

Šroub stavěcí
Adjusting screw

SSt	Ti	A
397 129 77 1580	397 129 77 1583	32 mm
397 129 77 1590	397 129 77 1593	47 mm

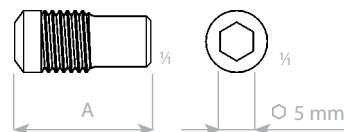
Zátka
End cap

SSt	Ti	A
397 129 77 1610	397 129 77 1613	18 mm

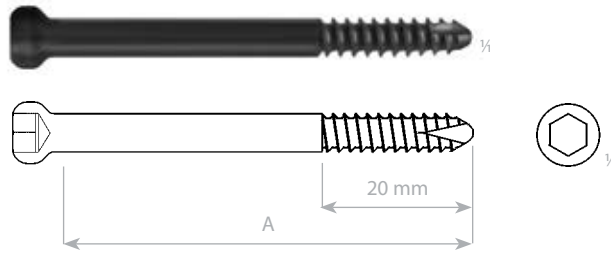
IMPLANTÁTY PRO HŘEBY REKONSTRUKČNÍ
IMPLANTS FOR RECONSTRUCTION NAILS

průměr závitu	thread diameter	5,0 mm
průměr dřívku	shank diameter	5,0 mm
průměr jádra	core diameter	3,5 mm
průměr hlavy	head diameter	8,0 mm
vrták pro závit	drill bit for threaded hole	Ø 3,5 mm
vrták pro kluzný otvor	drill bit for gliding hole	Ø 5,0 mm
šroubovák	screwdriver	Ø 5,0 mm

Šroub zajišťovací 5 mm, závit 20 mm
Locking screw 5 mm, thread 20 mm

SSt	Ti	A
397 129 79 1500	397 129 79 1503	25 mm
397 129 79 1520	397 129 79 1523	30 mm
397 129 79 1540	397 129 79 1543	35 mm
397 129 79 1560	397 129 79 1563	40 mm
397 129 79 1580	397 129 79 1583	45 mm
397 129 79 1600	397 129 79 1603	50 mm
397 129 79 1620	397 129 79 1623	55 mm
397 129 79 1640	397 129 79 1643	60 mm
397 129 79 1660	397 129 79 1663	65 mm
397 129 79 1680	397 129 79 1683	70 mm
397 129 79 1700	397 129 79 1703	75 mm
397 129 79 1720	397 129 79 1723	80 mm
397 129 79 1740	397 129 79 1743	85 mm
397 129 79 1760	397 129 79 1763	90 mm

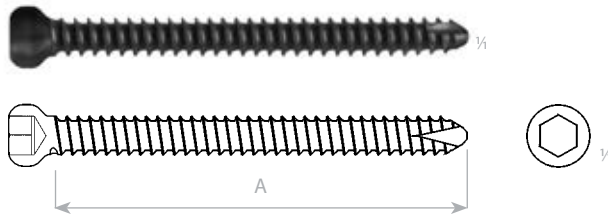

průměr závitu	thread diameter	5,0 mm
průměr jádra	core diameter	3,5 mm
průměr hlavy	head diameter	8,0 mm
vrták pro závit	drill bit for threaded hole	Ø 3,5 mm
vrták pro kluzný otvor	drill bit for gliding hole	Ø 5,0 mm
šroubovák	screwdriver	Ø 5,0 mm

Šroub zajišťovací 5 mm, plný závit
Locking screw 5 mm, fully threaded

SSt	Ti	A
397 129 79 1510	397 129 79 1513	25 mm
397 129 79 1530	397 129 79 1533	30 mm
397 129 79 1550	397 129 79 1553	35 mm
397 129 79 1570	397 129 79 1573	40 mm
397 129 79 1590	397 129 79 1593	45 mm
397 129 79 1610	397 129 79 1613	50 mm
397 129 79 1630	397 129 79 1633	55 mm
397 129 79 1650	397 129 79 1653	60 mm
397 129 79 1670	397 129 79 1673	65 mm
397 129 79 1690	397 129 79 1693	70 mm
397 129 79 1710	397 129 79 1713	75 mm
397 129 79 1730	397 129 79 1733	80 mm
397 129 79 1750	397 129 79 1753	85 mm
397 129 79 1770	397 129 79 1773	90 mm
397 129 79 1290	397 129 79 1293	95 mm
397 129 79 1300	397 129 79 1303	100 mm
397 129 79 1310	397 129 79 1313	105 mm

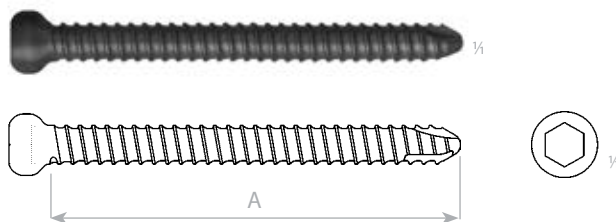

průměr závitu	thread diameter	5,0 mm
průměr jádra	core diameter	4,4 mm
průměr hlavy	head diameter	8,0 mm
vrták pro závit	drill bit for threaded hole	Ø 4,4 mm
vrták pro kluzný otvor	drill bit for gliding hole	Ø 5,0 mm
šroubovák	screwdriver	Ø 5,0 mm

Šroub zajišťovací zesílený 5 mm
Locking screw strengthened 5 mm

SSt	Ti	A
397 129 79 9631	397 129 79 9634	25 mm
397 129 79 9641	397 129 79 9644	30 mm
397 129 79 9651	397 129 79 9654	35 mm
397 129 79 9661	397 129 79 9664	40 mm
397 129 79 9671	397 129 79 9674	45 mm
397 129 79 9681	397 129 79 9684	50 mm
397 129 79 9691	397 129 79 9694	55 mm
397 129 79 9701	397 129 79 9704	60 mm
397 129 79 9711	397 129 79 9714	65 mm
397 129 79 9721	397 129 79 9724	70 mm
397 129 79 9731	397 129 79 9734	75 mm
397 129 79 9741	397 129 79 9744	80 mm
397 129 79 9751	397 129 79 9754	85 mm
397 129 79 9761	397 129 79 9764	90 mm

INSTRUMENTÁRIUM PRO HŘEBY REKONSTRUKČNÍ
INSTRUMENTS FOR RECONSTRUCTION NAILS
**397 139 09 0280**

Set PFN

síto 1 + síto 2 + nástroje

540 × 240 × 50 mm + 540 × 240 × 70 mm

Set PFN

sieve 1 + sieve 2 + instruments

540 × 240 × 50 mm + 540 × 240 × 70 mm

**397 129 69 5770**

soubor

nástroje pro síto 1

set

instruments for sieve 1

1	397 129 69 5310	Cílič PFN MEDIN 130° a 135°	
2	397 129 69 8130	Šroub cíliče, vnitřní šestihran 7 mm	
3	397 129 69 5330	Pouzdro 12/10×163 mm	
4	397 129 69 5340	Pouzdro 10/3×171 mm	
5	397 129 69 5350	Pouzdro 10/8×171 mm	
6	397 129 69 5360	Pouzdro 10/8×130 mm	
7	397 129 69 5370	Pouzdro 8/3,5×135 mm	
8	397 129 69 5380	Důlčík 8 mm	
9	397 129 69 5390	Důlčík 10 mm	
10	397 129 69 5400	Měrka	
11	397 129 69 5410	Vrták PFN 4,5/8×440 mm	
12	397 129 69 5420	Fréza kanylovaná	
13	397 129 69 5430	Šroubovák	
14	397 129 69 5660	Naražeč	
15	397 129 69 2140	Hloubkoměr	
16	397 129 79 4991	Vrták Ø3,5	

pokračování

	PFN MEDIN aiming device 130° a 135°	1
	Screw of aiming device, inner hexagon 7 mm	2
	Sleeve 12/10×163 mm	2
	Sleeve 10/3×171 mm	2
	Sleeve 10/8×171 mm	2
	Sleeve 10/8×130 mm	1
	Sleeve 8/3,5×135 mm	1
	Trocar 8 mm	1
	Trocar 10 mm	1
	Wire gauge	1
	Drill PFN 4,5/8×440 mm	1
	Cannulated reamer	1
	Screwdriver	1
	Impactor	1
	Depth gauge	1
	Drill Ø3.5	1

continuation

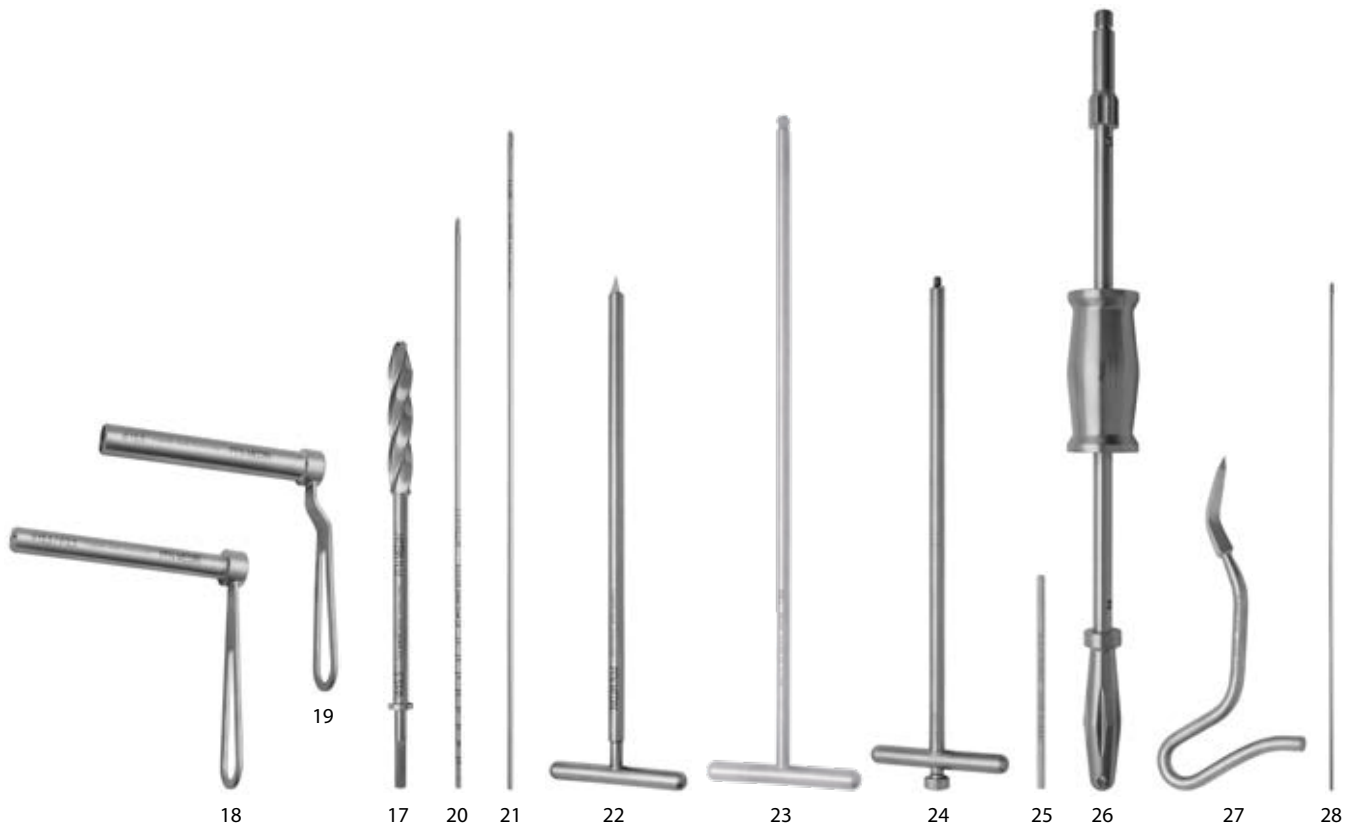
INSTRUMENTÁRIUM PRO HŘEBY REKONSTRUKČNÍ
 INSTRUMENTS FOR RECONSTRUCTION NAILS

397 129 69 5770

 soubor
 nástroje pro síto 2

 set
 instruments for sieve 2

pokračování

continuation

17	397 129 69 5470	Fréza předvrtávací; 15,5×285 mm
18	397 129 69 5480	Pouzdro středící; 15,5/3×158 mm
19	397 129 69 5490	Pouzdro ochranné; 19/15,5×145 mm
20	397 129 69 5500	Drát vodící Ø3×330 mm
21	397 129 69 5510	Drát vodící Ø3×400 mm
22	397 129 69 5520	Perforátor ruční
23	397 129 69 8050	Šroubovák 7×390 mm; šestihran
24	397 129 69 1590	Klíč
25	397 129 69 5700	Klíč univerzální
26	397 129 69 5670	Kladivo PFN (tyč, závaží 1000 g, držadlo)
27	397 129 09 0700	Perforátor zahnutý; 12×195 mm
28	397 129 09 2560	K-drát MEDIN; 1,8×300 mm

Reamer; 15.5×285 mm	ks/pcs
Centering sleeve; 15.5/3×158 mm	1
Protecting sleeve; 19/15.5×145 mm	1
Introducing wire; 3×330 mm	1
Introducing wire; 3×400 mm	3
Hand perforator	2
Screwdriver, hexagonal 7×390 mm	1
T-wrench	1
Rod	1
Mallet PFN (axis, weight 1000 g, holder)	2
Perforator curved; 12×195 mm	1
MEDIN K-wire; 1.8×300 mm	1
	3

397 129 69 5580 Síto 1 – PFN MEDIN
 540 × 240 × 50 mm

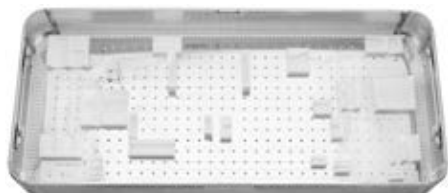
 Sieve 1 – PFN MEDIN
 540 × 240 × 50 mm

397 129 69 5590 Síto 2 – PFN MEDIN
 540 × 240 × 70 mm

 Sieve 2 – PFN MEDIN
 540 × 240 × 70 mm

INSTRUMENTÁRIUM PRO HŘEBY REKONSTRUKČNÍ
INSTRUMENTS FOR RECONSTRUCTION NAILS

397 139 09 0290 Set PFN pro zajišťovací šrouby zesílené
síta 1 + síta 2 + nástroje

Set PFN MEDIN for strengthened locking screws
sieve 1 + sieve 2 + instruments

7 **397 129 79 8461**
16 **397 129 79 8431**

alternativní nástroje
Pouzdro Ø10/Ø4,4
Vrták Ø4,4

alternative instruments
Sleeve Ø10/Ø4.4
Drill Ø4.4

ks/pcs
1
1

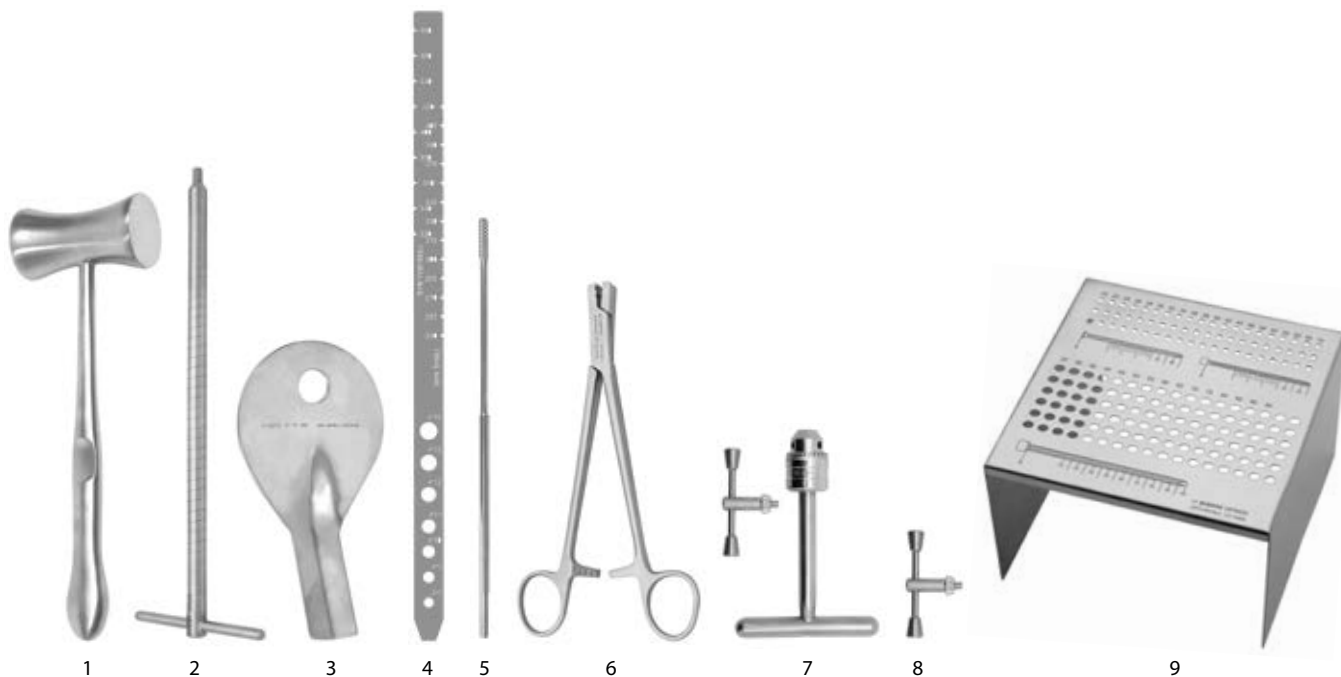
Doplňkové nástroje
Supplementary instruments

1	397 128 08 0921	Kladivo chirurgické kovové 700 g	Mallet metallic 700 g
2	397 129 69 1230	Klíč flexibilní 5x250 mm; šestihran	Flexible wrench; 5x250 mm
3	397 129 79 1990	Chráníč 86x157 mm	Skin protector 86x157 mm
4	397 129 79 2120	Měřítka RTG kontrastní; 495 mm	RTG rule; 495 mm
5	397 129 79 3500	Závitník 1, 220 mm	Tap 1; 220 mm
6	397 129 79 3610	Svorka na zavaděč nitrodřeňového hřebu; 187 mm	Holding forceps for introducing wires; 187 mm
7	397 129 79 3990	Skličidlo ruční, komplet	Hand chuck; complete
8	397 129 79 4020	Klíčka ručního sklíčidla	Chuck key
9	397 129 79 4030	Stojánek pro zajišťovací šrouby	Stand for locking screws

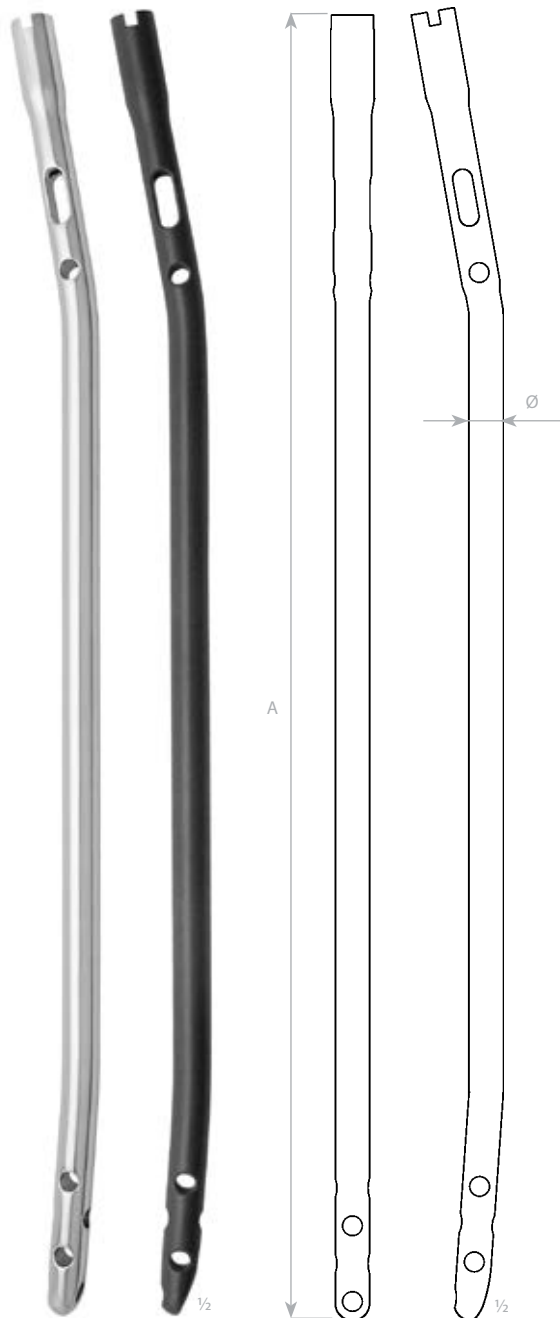
Hřeb tibiální plný
 Tibial nail full

SSt	Ti	A	Ø
397 129 77 6020	397 129 77 6023	240 mm	8 mm
397 129 77 6030	397 129 77 6033	255 mm	8 mm
397 129 77 6040	397 129 77 6043	270 mm	8 mm
397 129 77 6050	397 129 77 6053	285 mm	8 mm
397 129 77 6060	397 129 77 6063	300 mm	8 mm
397 129 77 6070	397 129 77 6073	315 mm	8 mm
397 129 77 6080	397 129 77 6083	330 mm	8 mm
397 129 77 6090	397 129 77 6093	345 mm	8 mm
397 129 77 6100	397 129 77 6103	360 mm	8 mm
397 129 77 6110	397 129 77 6113	270 mm	9 mm
397 129 77 6120	397 129 77 6123	285 mm	9 mm
397 129 77 6130	397 129 77 6133	300 mm	9 mm
397 129 77 6140	397 129 77 6143	315 mm	9 mm
397 129 77 6150	397 129 77 6153	330 mm	9 mm
397 129 77 6160	397 129 77 6163	345 mm	9 mm
397 129 77 6170	397 129 77 6173	360 mm	9 mm
397 129 77 6180	397 129 77 6183	375 mm	9 mm
397 129 77 6190	397 129 77 6193	390 mm	9 mm
397 129 77 6490	397 129 77 6493	405 mm	9 mm
397 129 77 6500	397 129 77 6503	420 mm	9 mm
397 129 77 6200	397 129 77 6203	270 mm	10 mm
397 129 77 6210	397 129 77 6213	285 mm	10 mm
397 129 77 6220	397 129 77 6223	300 mm	10 mm
397 129 77 6230	397 129 77 6233	315 mm	10 mm
397 129 77 6240	397 129 77 6243	330 mm	10 mm
397 129 77 6250	397 129 77 6253	345 mm	10 mm
397 129 77 6260	397 129 77 6263	360 mm	10 mm
397 129 77 6270	397 129 77 6273	375 mm	10 mm
397 129 77 6280	397 129 77 6283	390 mm	10 mm
397 129 77 6290	397 129 77 6293	405 mm	10 mm
397 129 77 6300	397 129 77 6303	420 mm	10 mm

397 129 69 6600 Síto s košem pro hřeby tibiální Ø9–12 mm
 540 × 240 × 130 mm

 Sieve with basket for tibial nails Ø9–12 mm
 540 × 240 × 130 mm

Pro uložení jedné řady hřebů (11×1 ks) a dalších tří sítí. For one row of nails (11×1 pc) and three other sieves.

397 129 69 6592 Síto na hřeby tibiální Ø8 mm
 500 × 210 × 53 mm

 Sieve for tibial nails Ø8 mm
 500 × 210 × 53 mm

Pro uložení jedné řady hřebů Ø8 (9×1 ks).
For one row of nails Ø8 (9×1 pc).

397 129 69 6590 Síto na hřeby tibiální Ø9–12 mm
 500 × 210 × 53 mm

 Sieve for tibial nails Ø9–12 mm
 500 × 210 × 53 mm

Pro uložení jedné řady hřebů (11×1 ks).
For one row of nails (11×1 pc).

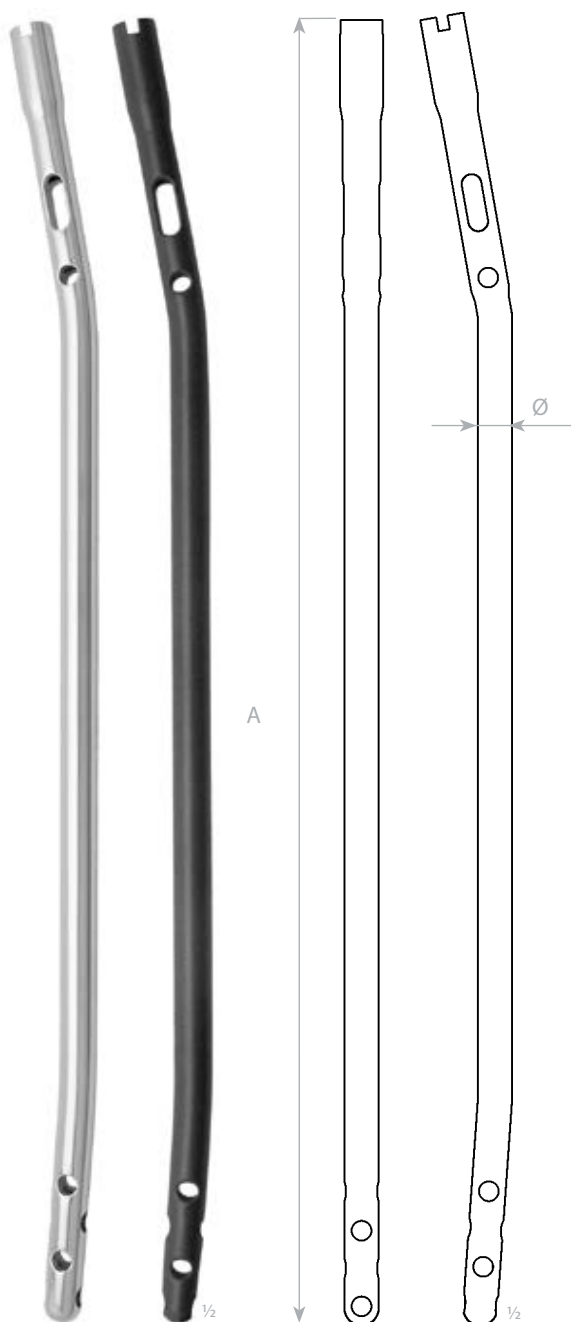
HŘEBY TIBIÁLNÍ
TIBIAL NAILS

Hřeb tibiální nitrodřeňový kanylovaný
Tibial nail cannulated

SSt	Ti	A	Ø
397 129 77 7610	397 129 77 7613	270 mm	9 mm
397 129 77 7620	397 129 77 7623	285 mm	9 mm
397 129 77 7630	397 129 77 7633	300 mm	9 mm
397 129 77 7640	397 129 77 7643	315 mm	9 mm
397 129 77 7650	397 129 77 7653	330 mm	9 mm
397 129 77 7660	397 129 77 7663	345 mm	9 mm
397 129 77 7670	397 129 77 7673	360 mm	9 mm
397 129 77 7680	397 129 77 7683	375 mm	9 mm
397 129 77 7690	397 129 77 7693	390 mm	9 mm
397 129 77 7700	397 129 77 7703	405 mm	9 mm
397 129 77 7710	397 129 77 7713	420 mm	9 mm
397 129 77 6750	397 129 77 6753	270 mm	10 mm
397 129 77 6760	397 129 77 6763	285 mm	10 mm
397 129 77 6770	397 129 77 6773	300 mm	10 mm
397 129 77 6780	397 129 77 6783	315 mm	10 mm
397 129 77 6790	397 129 77 6793	330 mm	10 mm
397 129 77 6800	397 129 77 6803	345 mm	10 mm
397 129 77 6810	397 129 77 6813	360 mm	10 mm
397 129 77 6820	397 129 77 6823	375 mm	10 mm
397 129 77 6830	397 129 77 6833	390 mm	10 mm
397 129 77 6840	397 129 77 6843	405 mm	10 mm
397 129 77 6850	397 129 77 6853	420 mm	10 mm
397 129 77 6310	397 129 77 6313	270 mm	11 mm
397 129 77 6320	397 129 77 6323	285 mm	11 mm
397 129 77 6330	397 129 77 6333	300 mm	11 mm
397 129 77 6340	397 129 77 6343	315 mm	11 mm
397 129 77 6350	397 129 77 6353	330 mm	11 mm
397 129 77 6360	397 129 77 6363	345 mm	11 mm
397 129 77 6370	397 129 77 6373	360 mm	11 mm
397 129 77 6380	397 129 77 6383	375 mm	11 mm
397 129 77 6390	397 129 77 6393	390 mm	11 mm
397 129 77 6400	397 129 77 6403	270 mm	12 mm
397 129 77 6410	397 129 77 6413	285 mm	12 mm
397 129 77 6420	397 129 77 6423	300 mm	12 mm
397 129 77 6430	397 129 77 6433	315 mm	12 mm
397 129 77 6440	397 129 77 6443	330 mm	12 mm
397 129 77 6450	397 129 77 6453	345 mm	12 mm
397 129 77 6460	397 129 77 6463	360 mm	12 mm
397 129 77 6470	397 129 77 6473	375 mm	12 mm
397 129 77 6480	397 129 77 6483	390 mm	12 mm

397 129 69 6600 Síto s košem pro hřebý tibiální Ø9–12 mm
 540 × 240 × 130 mm

 Sieve with basket for tibial nails Ø9–12 mm
 540 × 240 × 130 mm

Pro uložení jedné řady hřebů (11×1 ks) a dalších tří sítí. For one row of nails (11×1 pc) and three other sieves.

397 129 69 6590 Síto na hřebý tibiální Ø9–12 mm
 500 × 210 × 53 mm

 Sieve for tibial nails Ø9–12 mm
 500 × 210 × 53 mm

Pro uložení jedné řady hřebů (11×1 ks). For one row of nails (11×1 pc).

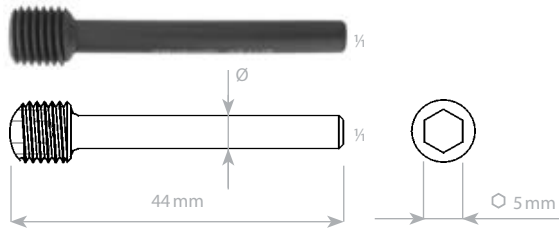
IMPLANTÁTY PRO HŘEBY TIBIÁLNÍ
IMPLANTS FOR TIBIAL NAILS

Šroub kompresní
Compression screw

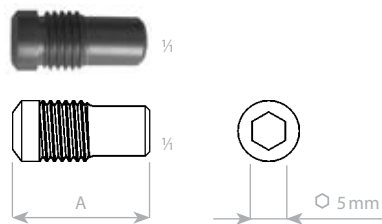
SSt	Ti	Ø	pro hřeb / for nail
397 129 79 1800	397 129 79 1803	3,2 mm	Ø 8 mm
397 129 79 1810	397 129 79 1813	4,4 mm	Ø 9–12 mm

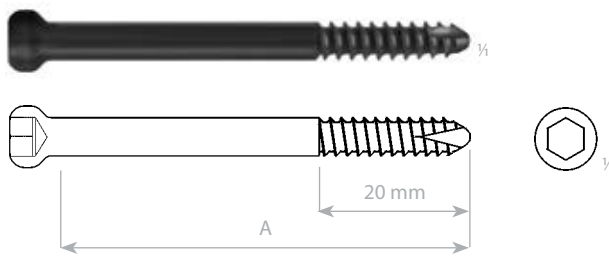

Zátka
End cap

SSt	Ti	A	
397 129 77 1610	397 129 77 1613	18 mm	Fig 0
397 129 77 1970	397 129 77 1973	23 mm	Fig 5
397 129 77 1980	397 129 77 1983	28 mm	Fig 10

Šroub zajišťovací 5 mm, závit 20 mm
Locking screw 5 mm, thread 20 mm

průměr závitu	thread diameter	5,0 mm
průměr dřívku	shank diameter	5,0 mm
průměr jádra	core diameter	3,5 mm
průměr hlavy	head diameter	8,0 mm
vrták pro závit	drill bit for threaded hole	Ø 3,5 mm
vrták pro kluzný otvor	drill bit for gliding hole	Ø 5,0 mm
šroubovák	screwdriver	Ø 5,0 mm

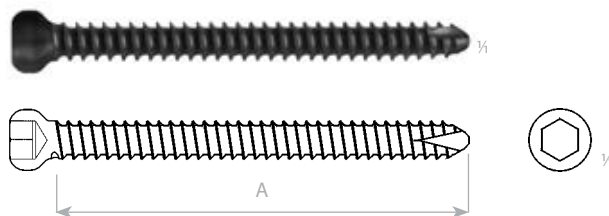
SSt	Ti	A
397 129 79 1500	397 129 79 1503	25 mm
397 129 79 1520	397 129 79 1523	30 mm
397 129 79 1540	397 129 79 1543	35 mm
397 129 79 1560	397 129 79 1563	40 mm
397 129 79 1580	397 129 79 1583	45 mm
397 129 79 1600	397 129 79 1603	50 mm
397 129 79 1620	397 129 79 1623	55 mm
397 129 79 1640	397 129 79 1643	60 mm
397 129 79 1660	397 129 79 1663	65 mm
397 129 79 1680	397 129 79 1683	70 mm
397 129 79 1700	397 129 79 1703	75 mm
397 129 79 1720	397 129 79 1723	80 mm
397 129 79 1740	397 129 79 1743	85 mm
397 129 79 1760	397 129 79 1763	90 mm

Šroub zajišťovací 5 mm, plný závit
Locking screw 5 mm, fully threaded

průměr závitu	thread diameter	5,0 mm
průměr jádra	core diameter	3,5 mm
průměr hlavy	head diameter	8,0 mm
vrták pro závit	drill bit for threaded hole	Ø 3,5 mm
vrták pro kluzný otvor	drill bit for gliding hole	Ø 5,0 mm
šroubovák	screwdriver	Ø 5,0 mm

SSt	Ti	A
397 129 79 1510	397 129 79 1513	25 mm
397 129 79 1530	397 129 79 1533	30 mm
397 129 79 1550	397 129 79 1553	35 mm
397 129 79 1570	397 129 79 1573	40 mm
397 129 79 1590	397 129 79 1593	45 mm
397 129 79 1610	397 129 79 1613	50 mm
397 129 79 1630	397 129 79 1633	55 mm
397 129 79 1650	397 129 79 1653	60 mm
397 129 79 1670	397 129 79 1673	65 mm
397 129 79 1690	397 129 79 1693	70 mm
397 129 79 1710	397 129 79 1713	75 mm
397 129 79 1730	397 129 79 1733	80 mm
397 129 79 1750	397 129 79 1753	85 mm
397 129 79 1770	397 129 79 1773	90 mm
397 129 79 1290	397 129 79 1293	95 mm
397 129 79 1300	397 129 79 1303	100 mm
397 129 79 1310	397 129 79 1313	105 mm

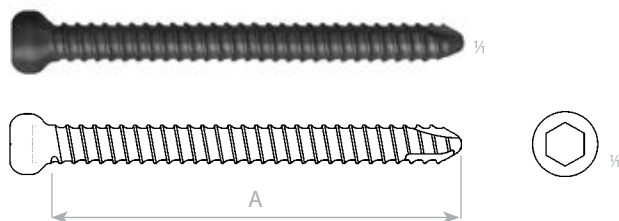
IMPLANTÁTY PRO HŘEBY TIBIÁLNÍ
IMPLANTS FOR TIBIAL NAILS

průměr závitu	thread diameter	5,0 mm
průměr jádra	core diameter	4,4 mm
průměr hlavy	head diameter	8,0 mm
vrták pro závit	drill bit for threaded hole	Ø 4,4 mm
vrták pro kluzný otvor	drill bit for gliding hole	Ø 5,0 mm
šroubovák	screwdriver	Ø 5,0 mm

Šroub zajišťovací zesílený 5 mm
Locking screw strengthened 5 mm

SSt	Ti	A
397 129 79 9631	397 129 79 9634	25 mm
397 129 79 9641	397 129 79 9644	30 mm
397 129 79 9651	397 129 79 9654	35 mm
397 129 79 9661	397 129 79 9664	40 mm
397 129 79 9671	397 129 79 9674	45 mm
397 129 79 9681	397 129 79 9684	50 mm
397 129 79 9691	397 129 79 9694	55 mm
397 129 79 9701	397 129 79 9704	60 mm
397 129 79 9711	397 129 79 9714	65 mm
397 129 79 9721	397 129 79 9724	70 mm
397 129 79 9731	397 129 79 9734	75 mm
397 129 79 9741	397 129 79 9744	80 mm
397 129 79 9751	397 129 79 9754	85 mm
397 129 79 9761	397 129 79 9764	90 mm

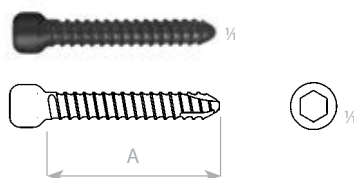

průměr závitu	thread diameter	3,5 mm
průměr jádra	core diameter	2,9 mm
průměr hlavy	head diameter	5,6 mm
vrták pro závit	drill bit for threaded hole	Ø 2,9 mm
vrták pro kluzný otvor	drill bit for gliding hole	Ø 3,5 mm
šroubovák	screwdriver	Ø 3,5 mm

Šroub zajišťovací zesílený 3,5 mm
Locking screw strengthened 3.5 mm

SSt	Ti	A
397 129 77 6551	397 129 77 6554	20 mm
397 129 77 6561	397 129 77 6564	22 mm
397 129 77 6571	397 129 77 6574	24 mm
397 129 77 6581	397 129 77 6584	26 mm
397 129 77 6591	397 129 77 6594	28 mm
397 129 77 6601	397 129 77 6604	30 mm
397 129 77 6611	397 129 77 6614	32 mm
397 129 77 6621	397 129 77 6624	34 mm
397 129 77 6631	397 129 77 6634	36 mm
397 129 77 6641	397 129 77 6644	38 mm
397 129 77 6651	397 129 77 6654	40 mm
397 129 77 6661	397 129 77 6664	42 mm
397 129 77 6671	397 129 77 6674	44 mm
397 129 77 6681	397 129 77 6684	46 mm
397 129 77 6691	397 129 77 6694	48 mm
397 129 77 6701	397 129 77 6704	50 mm
397 129 77 6711	397 129 77 6714	55 mm
397 129 77 6721	397 129 77 6724	60 mm
397 129 77 6731	397 129 77 6734	65 mm
397 129 77 6741	397 129 77 6744	70 mm



397 129 69 6570 Stojánek pro šrouby zajišťovací 5 a 3,5 mm
212 × 154 × 98 mm
bez implantátů

Stand for locking screws 5 and 3,5 mm
212 × 154 × 98 mm
excluding implants

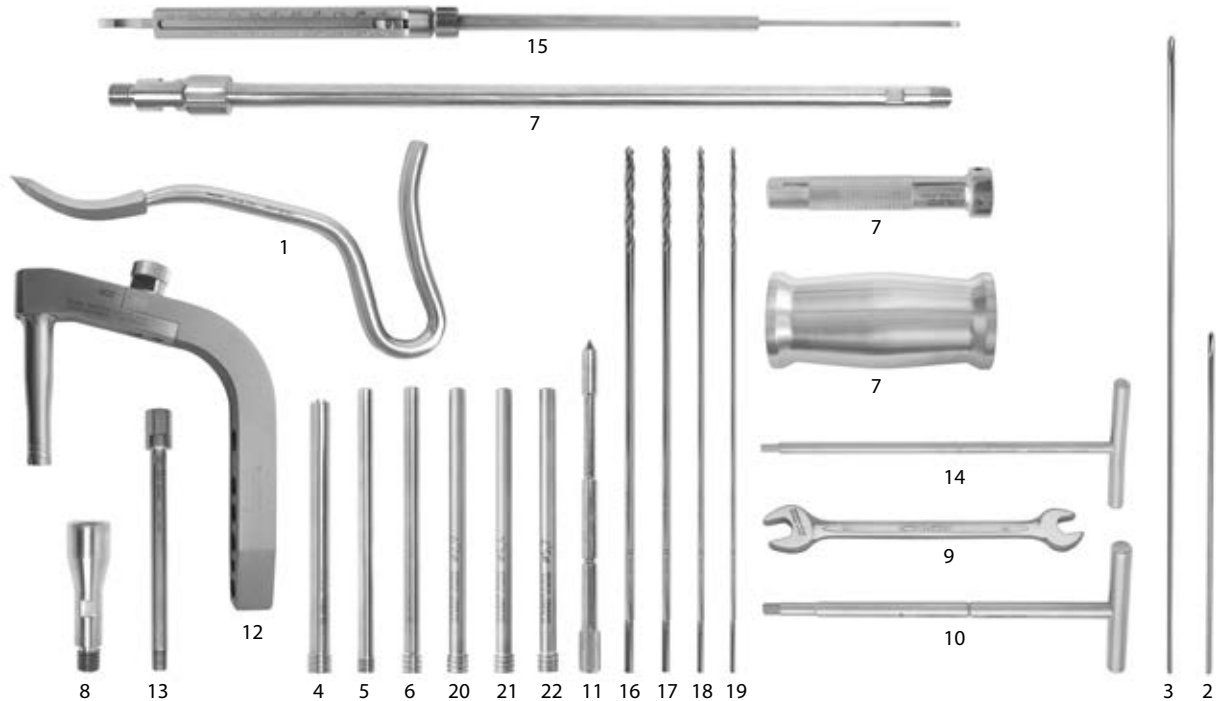
INSTRUMENTÁRIUM PRO HŘEBY NITRODŘEŇOVÉ
INSTRUMENTS FOR INTRAMEDULLARY NAILS

Instrumentárium pro zavádění nitrodřeňových hřebů
Instruments for introducing of intramedullary nails

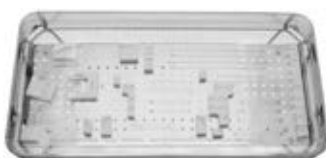
	soubor	set	ks / pcs
1	397 129 09 0700 Perforátor zahnutý; 12×195 mm	Perforator curved; 12×195 mm	1
2	397 129 09 2510 K-drát MEDIN 2,5×160 mm	MEDIN K-wire 2.5×160 mm	1
3	397 129 09 2590 K-drát MEDIN 2,5×300 mm	MEDIN K-wire 2.5×300 mm	1
4	397 129 69 1190 Pouzdro 2; 10/8 mm; 130 mm	Sleeve 2; 10/8 mm; 130 mm	1
5	397 129 69 1200 Pouzdro 3; 8/5 mm; 135 mm	Sleeve 3; 8/5 mm; 135 mm	1
6	397 129 69 1210 Pouzdro 4; 8/3,5 mm; 135 mm	Sleeve 4; 8/3.5 mm; 135 mm	1
7	397 129 69 1600 Kladivo	Mallet	1
8	397 129 69 1620 Naražec M12; 74 mm	Impactor; 74 mm	1
9	397 129 69 1630 Klíč 10/12; 130 mm	Wrench 10/12; 130 mm	1
10	397 129 69 1640 Šroubovák T; 5×175 mm	Screwdriver T; 5×175 mm	1
11	397 129 69 1650 Důlčík 7,9×158 mm	Trocar 7.9×158 mm	1
12	397 129 69 2590 Cíliče pro nitrodřeňový hřeb	Aiming device for intramedullary nails	1
13	397 129 69 2830 Šroub cíliče	Screw of aiming device	1
14	397 129 69 4050 Šroubovák T kanylovaný 3,5/1,8×175 mm; šestihran	Cannulated screwdriver T hexagonal; 3.5/1.8×175 mm	1
15	397 129 79 2111 Hloubkoměr	Depth gauge	1
16	397 129 79 4980 Vrták; 5×250 mm	Drill; 5.0×250 mm	1
17	397 129 79 4990 Vrták; 3,5×250 mm	Drill; 3.5×250 mm	2
18	397 129 79 8430 Vrták; 4,4×250 mm	Drill; 4.4×250 mm	1
19	397 129 79 8440 Vrták; 2,9×250 mm	Drill; 2.9×250 mm	1
20	397 129 79 8450 Pouzdro; 8/2,9 mm; 135 mm	Sleeve; 8/2.9 mm; 135 mm	1
21	397 129 79 8460 Pouzdro; 8/4,4 mm; 135 mm	Sleeve; 8/4.4 mm; 135 mm	1
22	397 129 79 8470 Pouzdro; 8/5,7 mm; 135 mm	Sleeve; 8/5.7 mm; 135 mm	1

Síta na instrumentárium
Sieves for instruments

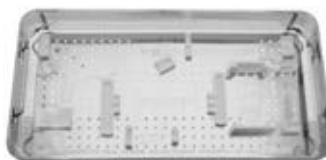
397 129 69 4530 Síto na instrumentárium pro hřebí nitrodřeňové Fig. 1; 480 × 240 × 50 mm

Sieve for instruments for intramedullary nails Fig. 1; 480 × 240 × 50 mm



397 129 69 4540 Síto na instrumentárium pro hřebí nitrodřeňové Fig. 2; 480 × 240 × 70 mm

Sieve for instruments for intramedullary nails Fig. 2; 480 × 240 × 70 mm

**Doplňkové nástroje**

Supplementary instruments

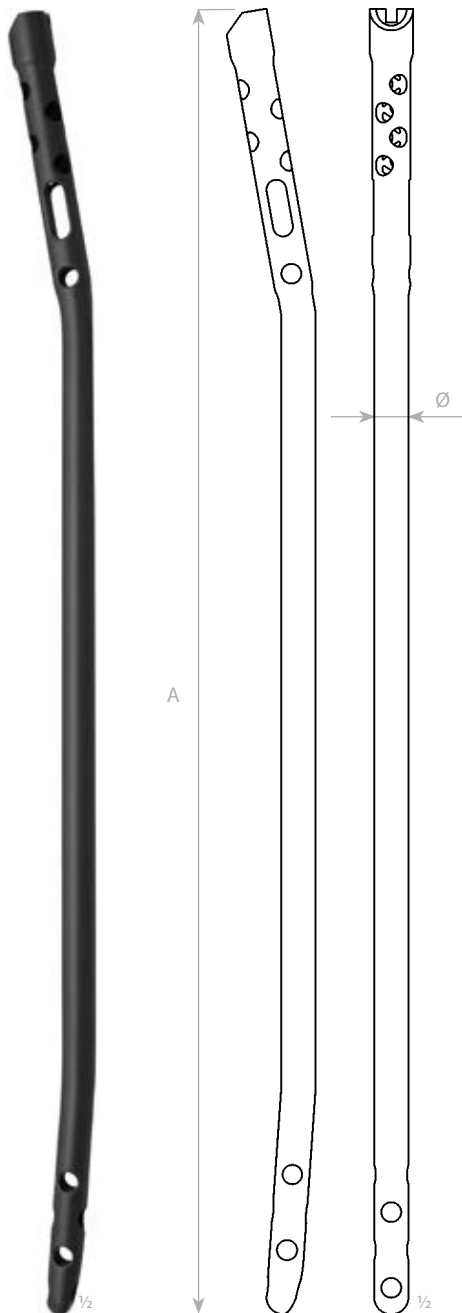
1	397 128 08 0921	Kladivo chirurgické kovové 700 g	Mallet metallic 700 g
2	397 129 09 0710	Perforátor zahnutý; 10×195 mm	Perforator curved; 10×195 mm
3	397 129 69 1220	Klíč flexibilní 12×250 mm; šestihran	Flexible wrench; 12×250 mm
4	397 129 69 1610	Tyč vytahovací M8/M12; 350 mm	Bar M8/M12; 350 mm
5	397 129 69 2140	Hloubkoměr; 270 mm	Depth gauge; 270 mm
6	397 129 79 1990	Chránič 86×157 mm	Skin protector 86×157 mm
7	397 129 79 2120	Měřítka RTG kontrastní; 495 mm	RTG rule; 495 mm
8	397 129 79 3500	Závitník 1, 220 mm	Tap 1; 220 mm
9	397 129 79 3610	Svorka na zavaděč nitrodřeňového hřebu; 187 mm	Holding forceps for introducing wires; 187 mm
10	397 129 79 3990	Sklíčidlo ruční, komplet	Hand chuck; complete
11	397 129 79 4020	Klíčka ručního sklíčidla	Chuck key
12	397 129 79 4030	Stojánek pro zajišťovací šrouby	Stand for locking screws
13	397 129 79 4981	Vrták; Ø5×250 mm; bílá	Drill; Ø5×250 mm; white
14	397 129 79 4991	Vrták; Ø3,5×250 mm; žlutá	Drill; Ø3.5×250 mm; yellow
15	397 129 79 8431	Vrták; Ø4,4×250 mm; červená	Drill; Ø4.4×250 mm; red
16	397 129 79 8441	Vrták; Ø2,9×250 mm; zelená	Drill; Ø2.9×250 mm; green

HŘEBY TIBIÁLNÍ PROXIMÁLNÍ
 PROXIMAL TIBIAL NAILS

Hřeb tibiální proximální plný
 Proximal tibial nail full

SSt	Ti	A	Ø
397 129 78 1500	397 129 78 1503	240 mm	8 mm
397 129 78 1510	397 129 78 1513	255 mm	8 mm
397 129 78 1520	397 129 78 1523	270 mm	8 mm
397 129 78 1530	397 129 78 1533	285 mm	8 mm
397 129 78 1540	397 129 78 1543	300 mm	8 mm
397 129 78 1550	397 129 78 1553	315 mm	8 mm
397 129 78 1560	397 129 78 1563	330 mm	8 mm
397 129 78 1570	397 129 78 1573	345 mm	8 mm
397 129 78 1580	397 129 78 1583	360 mm	8 mm
397 129 78 1610	397 129 78 1613	270 mm	9 mm
397 129 78 1620	397 129 78 1623	285 mm	9 mm
397 129 78 1630	397 129 78 1633	300 mm	9 mm
397 129 78 1640	397 129 78 1643	315 mm	9 mm
397 129 78 1650	397 129 78 1653	330 mm	9 mm
397 129 78 1660	397 129 78 1663	345 mm	9 mm
397 129 78 1670	397 129 78 1673	360 mm	9 mm
397 129 78 1680	397 129 78 1683	375 mm	9 mm
397 129 78 1690	397 129 78 1693	390 mm	9 mm
397 129 78 1700	397 129 78 1703	405 mm	9 mm
397 129 78 1710	397 129 78 1713	420 mm	9 mm
397 129 78 1740	397 129 78 1743	270 mm	10 mm
397 129 78 1750	397 129 78 1753	285 mm	10 mm
397 129 78 1760	397 129 78 1763	300 mm	10 mm
397 129 78 1770	397 129 78 1773	315 mm	10 mm
397 129 78 1780	397 129 78 1783	330 mm	10 mm
397 129 78 1790	397 129 78 1793	345 mm	10 mm
397 129 78 1800	397 129 78 1803	360 mm	10 mm
397 129 78 1810	397 129 78 1813	375 mm	10 mm
397 129 78 1820	397 129 78 1823	390 mm	10 mm
397 129 78 1830	397 129 78 1833	405 mm	10 mm
397 129 78 1840	397 129 78 1843	420 mm	10 mm

397 129 69 6600 Síto s košem pro hřebý tibiální Ø9–12 mm
 540 × 240 × 130 mm

 Sieve with basket for tibial nails Ø9–12 mm
 540 × 240 × 130 mm

Pro uložení jedné řady hřebů (11×1 ks) a dalších tří sit. *For one row of nails (11×1 pc) and three other sieves.*

397 129 69 6592 Síto na hřebý tibiální Ø8 mm
 500 × 210 × 53 mm

 Sieve for tibial nails Ø8 mm
 500 × 210 × 53 mm

Pro uložení jedné řady hřebů Ø8 (9×1 ks).
For one row of nails Ø8 (9×1 pc).

397 129 69 6590 Síto na hřebý tibiální Ø9–12 mm
 500 × 210 × 53 mm

 Sieve for tibial nails Ø9–12 mm
 500 × 210 × 53 mm

Pro uložení jedné řady hřebů (11×1 ks).
For one row of nails (11×1 pc).

HŘEBY TIBIÁLNÍ PROXIMÁLNÍ

PROXIMAL TIBIAL NAILS

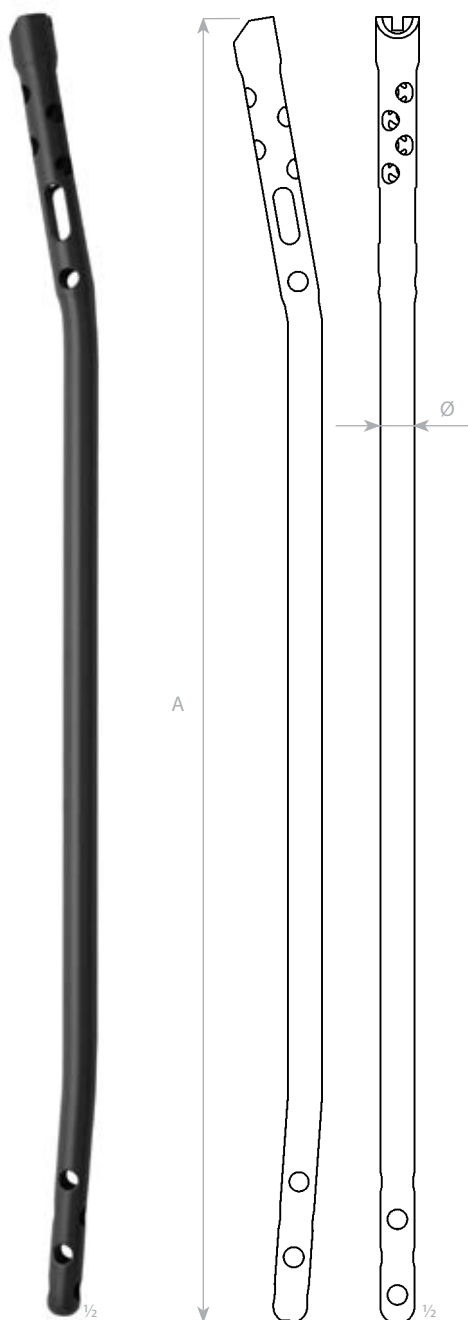

Hřeb tibiální proximální kanylovaný

Proximal tibial nail cannulated

SSt	Ti	A	Ø
397 129 78 2090	397 129 78 2093	270 mm	9 mm
397 129 78 2100	397 129 78 2103	285 mm	9 mm
397 129 78 2110	397 129 78 2113	300 mm	9 mm
397 129 78 2120	397 129 78 2123	315 mm	9 mm
397 129 78 2130	397 129 78 2133	330 mm	9 mm
397 129 78 2140	397 129 78 2143	345 mm	9 mm
397 129 78 2150	397 129 78 2153	360 mm	9 mm
397 129 78 2160	397 129 78 2163	375 mm	9 mm
397 129 78 2170	397 129 78 2173	390 mm	9 mm
397 129 78 2180	397 129 78 2183	405 mm	9 mm
397 129 78 2190	397 129 78 2193	420 mm	9 mm
397 129 78 2220	397 129 78 2223	270 mm	10 mm
397 129 78 2230	397 129 78 2233	285 mm	10 mm
397 129 78 2240	397 129 78 2243	300 mm	10 mm
397 129 78 2250	397 129 78 2253	315 mm	10 mm
397 129 78 2260	397 129 78 2263	330 mm	10 mm
397 129 78 2270	397 129 78 2273	345 mm	10 mm
397 129 78 2280	397 129 78 2283	360 mm	10 mm
397 129 78 2290	397 129 78 2293	375 mm	10 mm
397 129 78 2300	397 129 78 2303	390 mm	10 mm
397 129 78 2310	397 129 78 2313	405 mm	10 mm
397 129 78 2320	397 129 78 2323	420 mm	10 mm
397 129 78 1870	397 129 78 1873	270 mm	11 mm
397 129 78 1880	397 129 78 1883	285 mm	11 mm
397 129 78 1890	397 129 78 1893	300 mm	11 mm
397 129 78 1900	397 129 78 1903	315 mm	11 mm
397 129 78 1910	397 129 78 1913	330 mm	11 mm
397 129 78 1920	397 129 78 1923	345 mm	11 mm
397 129 78 1930	397 129 78 1933	360 mm	11 mm
397 129 78 1940	397 129 78 1943	375 mm	11 mm
397 129 78 1950	397 129 78 1953	390 mm	11 mm
397 129 78 1980	397 129 78 1983	270 mm	12 mm
397 129 78 1990	397 129 78 1993	285 mm	12 mm
397 129 78 2000	397 129 78 2003	300 mm	12 mm
397 129 78 2010	397 129 78 2013	315 mm	12 mm
397 129 78 2020	397 129 78 2023	330 mm	12 mm
397 129 78 2030	397 129 78 2033	345 mm	12 mm
397 129 78 2040	397 129 78 2043	360 mm	12 mm
397 129 78 2050	397 129 78 2053	375 mm	12 mm
397 129 78 2060	397 129 78 2063	390 mm	12 mm



397 129 69 6600 Síto s košem pro hřebky tibiální Ø9–12 mm
540 × 240 × 130 mm

Sieve with basket for tibial nails Ø9–12 mm
540 × 240 × 130 mm

Pro uložení jedné řady hřebů (11×1 ks) a dalších tří sítí. For one row of nails (11×1 pc) and three other sieves.



397 129 69 6590 Síto na hřebky tibiální Ø9–12 mm
500 × 210 × 53 mm

Sieve for tibial nails Ø9–12 mm
500 × 210 × 53 mm

Pro uložení jedné řady hřebů (11×1 ks). For one row of nails (11×1 pc).

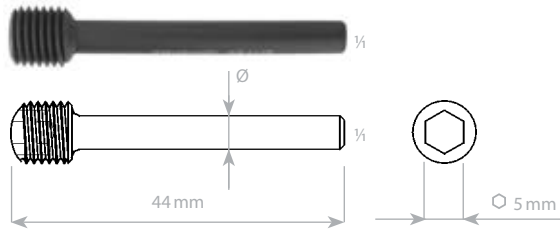
IMPLANTÁTY PRO HŘEBY TIBIÁLNÍ PROXIMÁLNÍ
 IMPLANTS FOR PROXIMAL TIBIAL NAILS

Šroub kompresní
 Compression screw

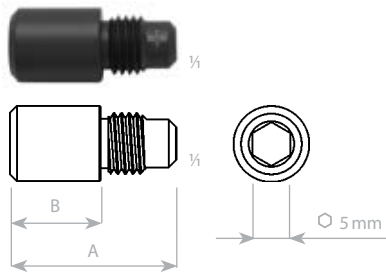
SSt	Ti	Ø	pro hřeb
397 129 79 1800	397 129 79 1803	3,2 mm	Ø 8 mm
397 129 79 1810	397 129 79 1813	4,4 mm	Ø 9–12 mm

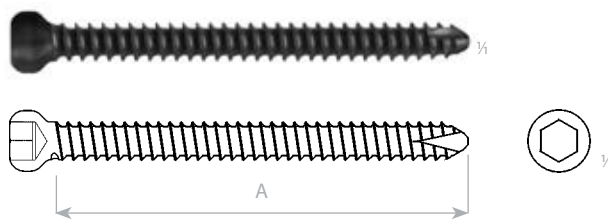

Zátka
 End cap

SSt	Ti	A	B
397 129 78 1420	397 129 78 1423	12 mm	0 mm
397 129 78 1430	397 129 78 1433	22 mm	5 mm
397 129 78 1440	397 129 78 1443	27 mm	10 mm

Šroub zajišťovací 5 mm, plný závit
 Locking screw 5 mm, fully threaded

SSt	Ti	A
397 129 79 1510	397 129 79 1513	25 mm
397 129 79 1530	397 129 79 1533	30 mm
397 129 79 1550	397 129 79 1553	35 mm
397 129 79 1570	397 129 79 1573	40 mm
397 129 79 1590	397 129 79 1593	45 mm
397 129 79 1610	397 129 79 1613	50 mm
397 129 79 1630	397 129 79 1633	55 mm
397 129 79 1650	397 129 79 1653	60 mm
397 129 79 1670	397 129 79 1673	65 mm
397 129 79 1690	397 129 79 1693	70 mm
397 129 79 1710	397 129 79 1713	75 mm
397 129 79 1730	397 129 79 1733	80 mm
397 129 79 1750	397 129 79 1753	85 mm
397 129 79 1770	397 129 79 1773	90 mm
397 129 79 1290	397 129 79 1293	95 mm
397 129 79 1300	397 129 79 1303	100 mm
397 129 79 1310	397 129 79 1313	105 mm

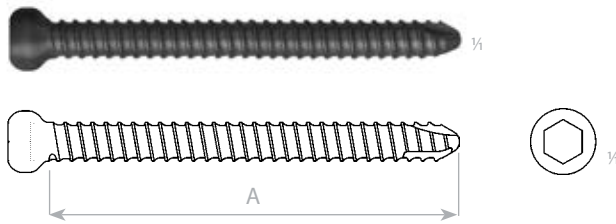
průměr závitů	thread diameter	5,0 mm
průměr jádra	core diameter	3,5 mm
průměr hlavy	head diameter	8,0 mm
vrtač pro závit	drill bit for threaded hole	Ø 3,5 mm
vrtač pro kluzný otvor	drill bit for gliding hole	Ø 5,0 mm
šroubovák	screwdriver	Ø 5,0 mm

IMPLANTÁTY PRO HŘEBY TIBIÁLNÍ PROXIMÁLNÍ
IMPLANTS FOR PROXIMAL TIBIAL NAILS

průměr závitu	thread diameter	5,0 mm
průměr jádra	core diameter	4,4 mm
průměr hlavy	head diameter	8,0 mm
vrták pro závit	drill bit for threaded hole	Ø 4,4 mm
vrták pro kluzný otvor	drill bit for gliding hole	Ø 5,0 mm
šroubovák	screwdriver	Ø 5,0 mm

Šroub zajišťovací zesílený 5 mm
Locking screw strengthened 5 mm

SSt	Ti	A
397 129 79 9631	397 129 79 9634	25 mm
397 129 79 9641	397 129 79 9644	30 mm
397 129 79 9651	397 129 79 9654	35 mm
397 129 79 9661	397 129 79 9664	40 mm
397 129 79 9671	397 129 79 9674	45 mm
397 129 79 9681	397 129 79 9684	50 mm
397 129 79 9691	397 129 79 9694	55 mm
397 129 79 9701	397 129 79 9704	60 mm
397 129 79 9711	397 129 79 9714	65 mm
397 129 79 9721	397 129 79 9724	70 mm
397 129 79 9731	397 129 79 9734	75 mm
397 129 79 9741	397 129 79 9744	80 mm
397 129 79 9751	397 129 79 9754	85 mm
397 129 79 9761	397 129 79 9764	90 mm

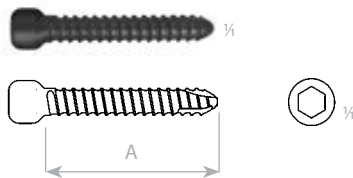

průměr závitu	thread diameter	3,5 mm
průměr jádra	core diameter	2,9 mm
průměr hlavy	head diameter	5,6 mm
vrták pro závit	drill bit for threaded hole	Ø 2,9 mm
vrták pro kluzný otvor	drill bit for gliding hole	Ø 3,5 mm
šroubovák	screwdriver	Ø 3,5 mm

Šroub zajišťovací zesílený 3,5 mm
Locking screw strengthened 3.5 mm

SSt	Ti	A
397 129 77 6551	397 129 77 6554	20 mm
397 129 77 6561	397 129 77 6564	22 mm
397 129 77 6571	397 129 77 6574	24 mm
397 129 77 6581	397 129 77 6584	26 mm
397 129 77 6591	397 129 77 6594	28 mm
397 129 77 6601	397 129 77 6604	30 mm
397 129 77 6611	397 129 77 6614	32 mm
397 129 77 6621	397 129 77 6624	34 mm
397 129 77 6631	397 129 77 6634	36 mm
397 129 77 6641	397 129 77 6644	38 mm
397 129 77 6651	397 129 77 6654	40 mm
397 129 77 6661	397 129 77 6664	42 mm
397 129 77 6671	397 129 77 6674	44 mm
397 129 77 6681	397 129 77 6684	46 mm
397 129 77 6691	397 129 77 6694	48 mm
397 129 77 6701	397 129 77 6704	50 mm
397 129 77 6711	397 129 77 6714	55 mm
397 129 77 6721	397 129 77 6724	60 mm
397 129 77 6731	397 129 77 6734	65 mm
397 129 77 6741	397 129 77 6744	70 mm

397 129 69 6570

 Stojánek pro šrouby zajišťovací 5 a 3,5 mm
 212 × 154 × 98 mm
 bez implantátů

 Stand for locking screws 5 and 3,5 mm
 212 × 154 × 98 mm
 excluding implants

INSTRUMENTÁRIUM PRO HŘEBY TIBIÁLNÍ PROXIMÁLNÍ
 INSTRUMENTS FOR PROXIMAL TIBIAL NAILS

397 139 09 0375 Set instrumentů pro hřeby tibiální
 540 × 240 × 90 mm
 včetně nástrojů

 Set of instruments for tibial nails
 540 × 240 × 90 mm
 including instruments

397 139 09 0370	soubor	set	ks/pcs	397 139 09 0370	soubor	set	ks/pcs
1	397 129 68 1040 Fréza předvrtávací Ø 9/12×180 mm	Predrilling cutter 9/12×180 mm	1	15	397 129 69 6420 Pouzdro Ø 8/3,5×171 mm	Sleeve Ø 8/3.5×171 mm	2
2	397 129 68 1050 Pouzdro ochranné Ø 12 mm	Protective sleeve Ø12 mm	1	16	397 129 69 9781 Vrták Ø 3,5×150 mm	Drill 3,5×150 mm	1
3	397 129 68 1060 Perforátor dláto Ø 12 mm kanylovaný	Perforator – chisel Ø12 mm cannulated	1	17	397 129 69 6631 Vrták Ø 3,5×320 mm	Drill Ø 3.5×320 mm	2
4	397 129 68 1020 Šroubovák 6HR 3,5×200 mm se zajiš.	Screwdriver hexagonal 3,5×200 mm	1	18	397 129 69 6430 Pouzdro Ø 8/4,4×171 mm	Sleeve Ø 8/4.4×171 mm	2
5	397 129 68 1030 Šroubovák 6HR 5×200 mm se zajištěním	Screwdriver hexagonal 5×200 mm	1	19	397 129 69 6641 Vrták Ø 4,4×320 mm	Drill Ø 4.4×320 mm	2
6	397 129 69 5670 Kladivo	Mallet	1	20	397 129 69 9771 Vrták Ø 2,9/150 mm	Drill 2,9×150 mm	1
7	397 129 69 5660 Naražec	Impactor	1	21	397 129 69 6440 Pouzdro Ø 8/2,9×171 mm	Sleeve Ø 8/2.9×171 mm	1
8	397 129 69 6100 Tyč dotahovací	Wrench rod	1	22	397 129 69 6460 Pouzdro Ø 8/2,5×171 mm	Sleeve Ø 8/2.5×171 mm	1
9	BD23-110-AO Držadlo AO; 30×151 mm	Handle AO; 30×151 mm	1	23	397 129 69 6470 Trokar Ø 8×182 mm	Trocar Ø 8×182 mm	1
10	BT19-095-AO Držadlo T AO; 95×81 mm	T-handle AO; 95×81 mm	1	24	397 129 69 6621 Vrták Ø 2,9×320 mm	Drill Ø 2.9×320 mm	2
11	397 129 69 7320 Redukce M12/M8×1	Thread adapter M12/M8×1	1	25	397 129 69 7210 Ucpávka Ø 10×30 mm	Plug 10×30 mm	4
12	397 129 69 6400 Pouzdro Ø 10/8×155 mm	Sleeve Ø 10/8×155 mm	3	26	397 129 69 9791 Vrták Ø 4,4×150 mm	Drill 4,4×150 mm	1
13	397 129 68 1100 Hlubkoměr	Deep gauge	1	27	397 129 09 2570 K-drát MEDIN Ø 2×300 mm	K-wire MEDIN Ø 2.0×300 mm	3
14	397 129 68 1090 Perforátor ohnutý kanylovaný Ø 13 mm	Perforator curved cannulated Ø 13 mm	1	28	397 129 69 5780 Cílič tibiální proximální	Aiming device for tibial prox. nails	1

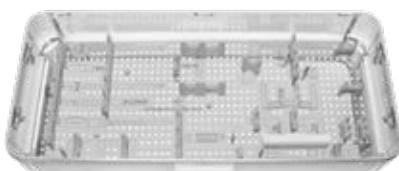
397 129 69 6610 Síto na instrumentárium pro hřeby
 tibiální proximální
 540 × 240 × 90 mm
 bez nástrojů

 Sieve for instruments for tibial nails
 540 × 240 × 90 mm
 excluding instruments

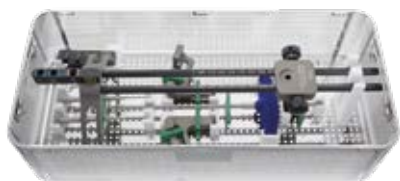
INSTRUMENTÁRIUM PRO HŘEBY TIBIÁLNÍ PROXIMÁLNÍ
INSTRUMENTS FOR PROXIMAL TIBIAL NAILS

397 139 09 0825 Set distálního cílení pro tibiální hřeby
540 × 240 × 130 mm
včetně nástrojů

Set of instruments for distal aiming of tibial nails
540 × 240 × 130 mm
including instruments



397 139 09 0820

soubor

set

- | | | |
|---|------------------------|--|
| 1 | 397 129 69 9250 | Cílič distální pro tibiální hřeby |
| 2 | 397 129 69 9740 | Pin kalibrační pro hřeb tibiální; 150 mm |
| 3 | 397 129 69 9970 | Bodec ruční; 8×250 mm |
| 4 | 397 129 69 6100 | Tyč dotahovací |

- | | |
|--|--|
| | Distal aiming device for tibial nails |
| | Calibration pin for tibial nails; 150 mm |
| | Hand perforator 8×250 mm |
| | Wrench rod |

ks/pcs

- | |
|---|
| 1 |
| 2 |
| 1 |
| 1 |

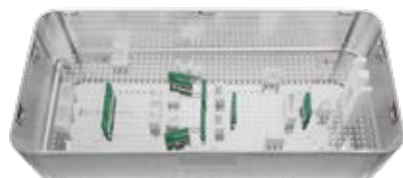

397 129 69 9710 Síto pro distální cílení pro tibiální hřeby
540 × 240 × 130 mm
bez nástrojů

Sieve for instruments for distal aiming
of tibial nails
540 × 240 × 130 mm
excluding instruments



C-NAIL hřeb patní, pravý
C-NAIL calcaneal nail, right

SSt
397 129 78 4160

C-NAIL hřeb patní, levý
C-NAIL calcaneal nail, left

SSt
397 129 78 4170

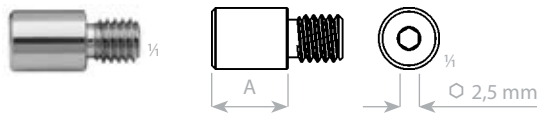

Zátka
End cap

SSt	A	
397 129 77 2210	0 mm	Fig. 0
397 129 77 2220	5 mm	Fig. 5
397 129 77 2230	10 mm	Fig. 10
397 129 78 8880	15 mm	Fig. 15
397 129 78 8890	20 mm	Fig. 20

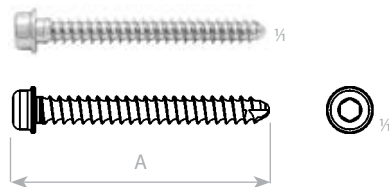

Šroub zajišťovací s plochou hlavou 3,5 mm
Locking screw with flanged head 3.5 mm

SSt	A
397 129 78 5651	22 mm
397 129 78 5661	24 mm
397 129 78 5671	26 mm
397 129 78 5681	28 mm
397 129 78 5691	30 mm
397 129 78 5701	32 mm
397 129 78 5711	34 mm
397 129 78 5721	36 mm
397 129 78 5731	38 mm
397 129 78 5741	40 mm
397 129 78 5751	42 mm
397 129 78 5761	44 mm
397 129 78 5771	46 mm
397 129 78 5781	48 mm
397 129 78 5791	50 mm
397 129 78 5801	55 mm
397 129 78 5811	60 mm
397 129 78 5821	65 mm
397 129 78 5831	70 mm

průměr závitu	thread diameter	3,5 mm
průměr jádra	core diameter	2,4 mm
průměr hlavy	head diameter	6,0 mm
vrták pro závit	drill bit for threaded hole	Ø 2,7 mm
šroubovák	screwdriver	Ø 2,5 mm

INSTRUMENTÁRIUM PRO C-NAIL HŘEBY PATNÍ
INSTRUMENTS FOR C-NAIL CALCANEAL NAILS

397 139 09 0545 Set instrumentů pro C-NAIL
540 × 240 × 130 mm
síto s nástroji, bez implantátů

Set of instruments for C-NAIL
540 × 240 × 130 mm
sieve including instruments, excluding implants
**397 139 09 0540**

soubor

set

			ks/pcs
1	397 129 69 4910	Cílič C-NAIL	1
2	397 129 69 6340	Pouzdro 8/6×110 mm	3
3	397 129 69 6670	Pouzdro 6/2×128 mm	2
4	397 129 69 6350	Pouzdro 6/2,7×128 mm	3
5	397 129 69 6300	Důlčík 6 mm	1
6	397 129 69 5800	Šroubovák 2,5×232 mm; šestihran	1
7	397 129 69 5810	Frézovací pouzdro 9,5/8 mm	1
8	397 129 69 5840	Pouzdro pro drát 8/2,5×49 mm	1
9	397 129 69 5830	Hloubkoměr	1
10	397 129 78 6750	K-drát MEDIN 2,5×200 mm	2
11	397 129 69 6680	K-drát MEDIN s olivkou 2×300 mm	2
12	397 129 69 6291	Vrták 2,7×230 mm	1
13	397 129 69 5851	Vrták 8/2,5×240 mm	1
14	397 129 69 6100	Tyč dotahovací	1

397 129 69 5980 Síto na instrumentárium pro C-NAIL
540 × 240 × 130 mm
síto bez nástrojů a implantátů

Sieve for instruments for C-NAIL
540 × 240 × 130 mm
sieve excluding instruments and implants

397 129 69 7180 Stojánek na šrouby pro C-NAIL
160 × 125 × 81 mm
bez implantátů

Stand for screws for C-NAIL
160 × 125 × 81 mm
excluding implants

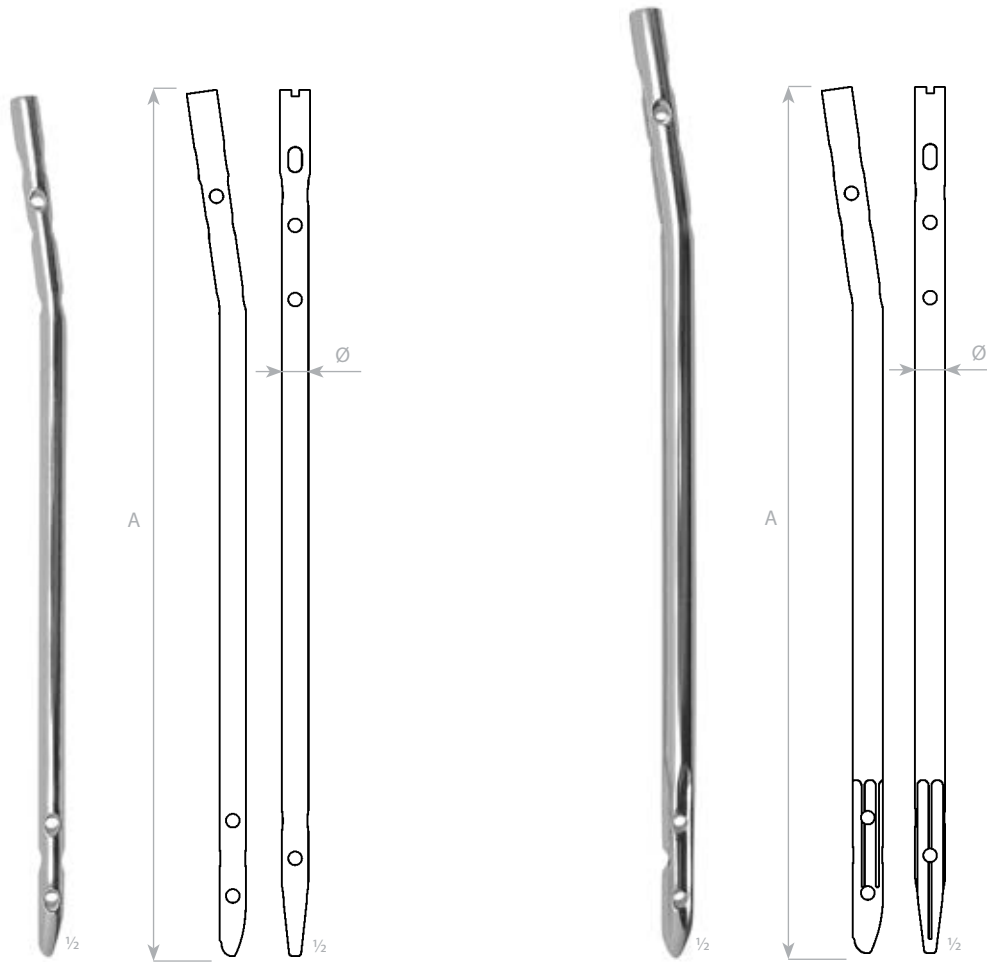
Hřeb humerální
 Humeral nail

SSt	Ti	A	Ø
397 129 77 2000	397 129 77 2003	190 mm	7 mm
397 129 77 2010	397 129 77 2013	210 mm	7 mm
397 129 77 2020	397 129 77 2023	230 mm	7 mm
397 129 77 2030	397 129 77 2033	250 mm	7 mm
397 129 77 2040	397 129 77 2043	270 mm	7 mm
397 129 77 2050	397 129 77 2053	290 mm	7 mm

SSt	Ti	A	Ø
397 129 77 2070	397 129 77 2073	190 mm	8 mm
397 129 77 2080	397 129 77 2083	210 mm	8 mm
397 129 77 2090	397 129 77 2093	230 mm	8 mm
397 129 77 2100	397 129 77 2103	250 mm	8 mm
397 129 77 2110	397 129 77 2113	270 mm	8 mm
397 129 77 2120	397 129 77 2123	290 mm	8 mm

397 129 77 2140	397 129 77 2143	210 mm	9 mm
397 129 77 2150	397 129 77 2153	230 mm	9 mm
397 129 77 2160	397 129 77 2163	250 mm	9 mm
397 129 77 2170	397 129 77 2173	270 mm	9 mm
397 129 77 2180	397 129 77 2183	290 mm	9 mm
397 129 77 2190	397 129 77 2193	310 mm	9 mm

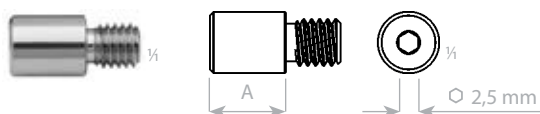
IMPLANTÁTY PRO HŘEBY HUMERÁLNÍ
IMPLANTS FOR HUMERAL NAILS**Zátka**
End cap

SSt	Ti	A	
397 129 77 2210	397 129 77 2213	0 mm	Fig. 0
397 129 77 2220	397 129 77 2223	5 mm	Fig. 5
397 129 77 2230	397 129 77 2233	10 mm	Fig. 10

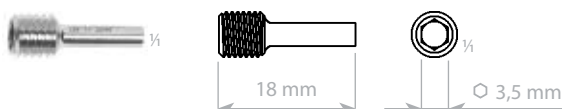
**Šroub kompresní**
Compression screw

SSt	Ti	
397 129 77 2240	397 129 77 2243	18 mm

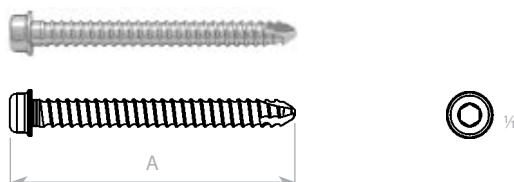
**Šroub zajišťovací zesílený s plochou hlavou 3,5 mm**
Locking screw strengthened with flanged head 3.5 mm

průměr závitu	thread diameter	3,5 mm
průměr jádra	core diameter	2,9 mm
průměr hlavy	head diameter	6,0 mm
vrták pro závit	drill bit for threaded hole	Ø 2,7/2,9 mm
šroubovák	screwdriver	Ø 2,5 mm

SSt	Ti	A
397 129 78 5841	397 129 78 5844	20 mm
397 129 78 5851	397 129 78 5854	22 mm
397 129 78 5861	397 129 78 5864	24 mm
397 129 78 5871	397 129 78 5874	26 mm
397 129 78 5881	397 129 78 5884	28 mm
397 129 78 5891	397 129 78 5894	30 mm
397 129 78 5901	397 129 78 5904	32 mm
397 129 78 5911	397 129 78 5914	34 mm
397 129 78 5921	397 129 78 5924	36 mm
397 129 78 5931	397 129 78 5934	38 mm
397 129 78 5941	397 129 78 5944	40 mm
397 129 78 5951	397 129 78 5954	42 mm
397 129 78 5961	397 129 78 5964	44 mm
397 129 78 5971	397 129 78 5974	46 mm
397 129 78 5981	397 129 78 5984	48 mm
397 129 78 5991	397 129 78 5994	50 mm
397 129 78 6001	397 129 78 6004	55 mm
397 129 78 6011	397 129 78 6014	60 mm
397 129 78 6021	397 129 78 6024	65 mm
397 129 78 6031	397 129 78 6034	70 mm

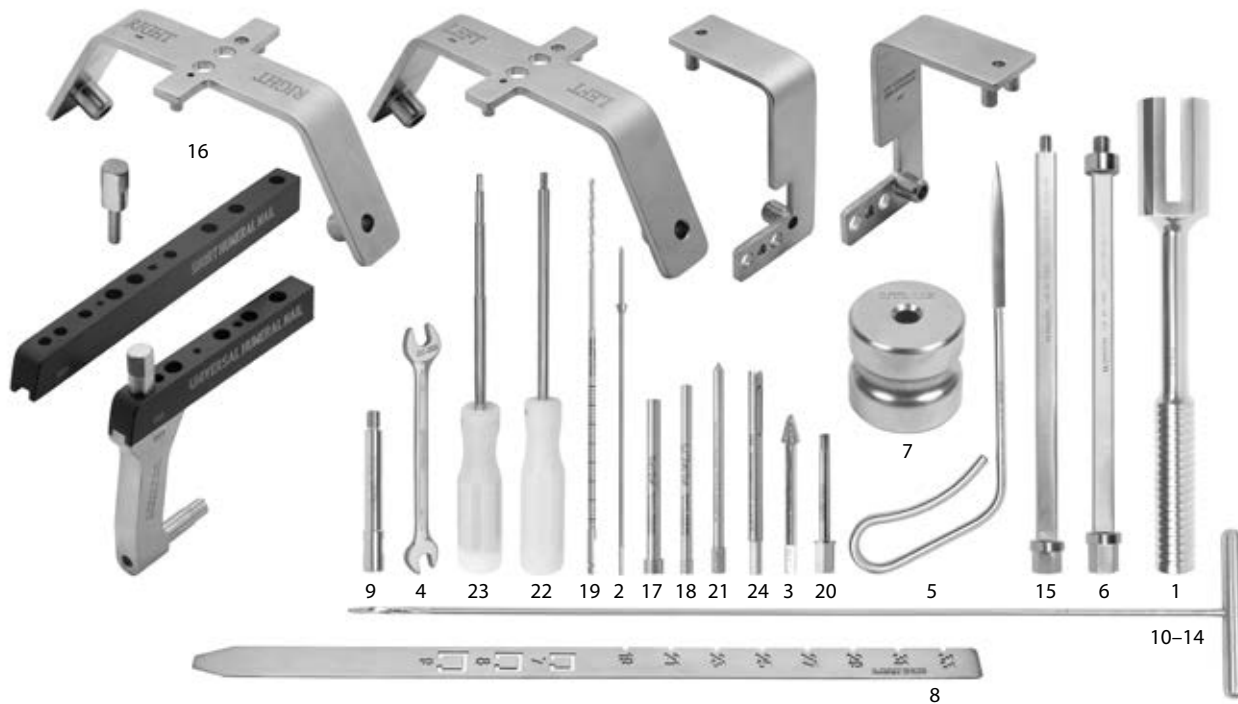
Instrumentárium pro hřebý humerální
 Instruments for humeral nails

	397 129 69 4200	soubor	set	ks/pcs
1	397 129 09 6120	Kladivo univerzální 38×250 mm	Mallet; 38×250 mm	1
2	397 129 09 9950	Drát s olivkou 2,5×170 mm	Wire with olive; 2,5×170 mm	1
3	397 129 69 1280	Fréza kostní kuželová; 80 mm	Bone cutter; 80 mm	1
4	397 129 69 1630	Klíč 10/12; 130 mm	Wrench 10/12; 130 mm	1
5	397 129 69 1670	Perforátor; 210 mm	Awl; 210 mm	1
6	397 129 69 1680	Osa kladiva zaváděcí; 195 mm	Introducing axis; 195 mm	1
7	397 129 69 1690	Závaží	Weight	1
8	397 129 69 1700	Měrka; 345 mm	Gauge; 345 mm	1
9	397 129 69 1730	Naražeč; 88 mm	Impactor; 88 mm	1
10	397 129 69 2260	Fréza humerální 5×450 mm	Humeral cutter; 5×450 mm	1
11	397 129 69 2270	Fréza humerální 6×450 mm	Humeral cutter; 6×450 mm	1
12	397 129 69 2280	Fréza humerální 7×450 mm	Humeral cutter; 7×450 mm	1
13	397 129 69 2290	Fréza humerální 8×450 mm	Humeral cutter; 8×450 mm	1
14	397 129 69 2300	Fréza humerální 9×450 mm	Humeral cutter; 9×450 mm	1
15	397 129 69 2320	Osa kladiva vytahovací; 204 mm	Extracting axis; 204 mm	1
16	397 129 69 4080	Cílič pro hřeb humerální, krátký, dlouhý, uni.	Aiming device humerus, type 3	1
17	397 129 69 4110	Pouzdro 8/6×100 mm	Sleeve 8/6×100 mm	1
18	397 129 69 4120	Pouzdro 6/2,7×110 mm	Sleeve 6/2,7×110 mm	1
19	397 129 69 4131	Vrták; 2,7×210 mm; značeno červenou	Drill; 2,7×210 mm; marking red	1
20	397 129 69 4140	Šroub cíliče	Screw of aiming device	1
21	397 129 69 4240	Důlčík humerální	Trocar humerus	1
22	397 129 79 3900	Šroubovák šestihran 3,5 mm; 214 mm	Screwdriver hexagonal; 3,5 mm; 214 mm	1
23	397 129 79 4340	Šroubovák šestihran 2,5 mm; 214 mm	Screwdriver hexagonal; 2,5 mm; 214 mm	1
24	397 129 79 9770	Fréza; 8 mm	Cutter; 8 mm	1

INSTRUMENTÁRIUM PRO HŘEBY HUMERÁLNÍ
INSTRUMENTS FOR HUMERAL NAILS

397 129 69 4470 Síto na instrumentárium pro hřeby humerální
540 × 240 × 70 mm
Fig. 1

Sieve for instruments for humeral nails
540 × 240 × 70 mm
Fig. 1



397 129 69 4480 Síto na instrumentárium pro hřeby humerální
540 × 240 × 90 mm
Fig. 2

Sieve for instruments for humeral nails
540 × 240 × 90 mm
Fig. 2



397 129 69 4490 Síto na instrumentárium pro hřeby humerální
540 × 240 × 60 mm
Fig. 3

Sieve for instruments for humeral nails
540 × 240 × 60 mm
Fig. 3

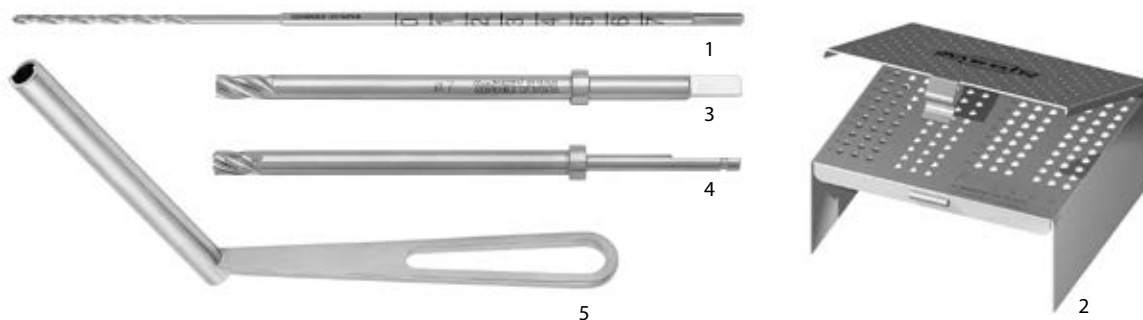
Doplňkové nástroje
Supplementary instruments

- | | | | |
|---|------------------------|---|-------------------------------------|
| 1 | 397 129 69 4130 | Vrták; 2,7×210 mm; značeno červenou | Drill; 2,7×210 mm; marking red |
| 2 | 397 129 78 2610 | Stojánek pro šrouby na humerus; 130×125×61 mm | Humerus screw holder; 130×125×61 mm |
| 3 | 397 129 78 2620 | Fréza čelní; 7 mm; 150 mm | Head-on cutter; 7 mm; 150 mm |
| 4 | 397 129 78 2621 | Fréza čelní; 7 mm; 150 mm | Head-on cutter; 7 mm; 150 mm |
| 5 | 397 129 78 2630 | Pouzdro frézovací; 7,2 mm; 100 mm | Cutting sleeve; 7.2 mm; 100 mm |

HŘEBY HUMERÁLNÍ KRÁTKÉ
SHORT HUMERAL NAILS

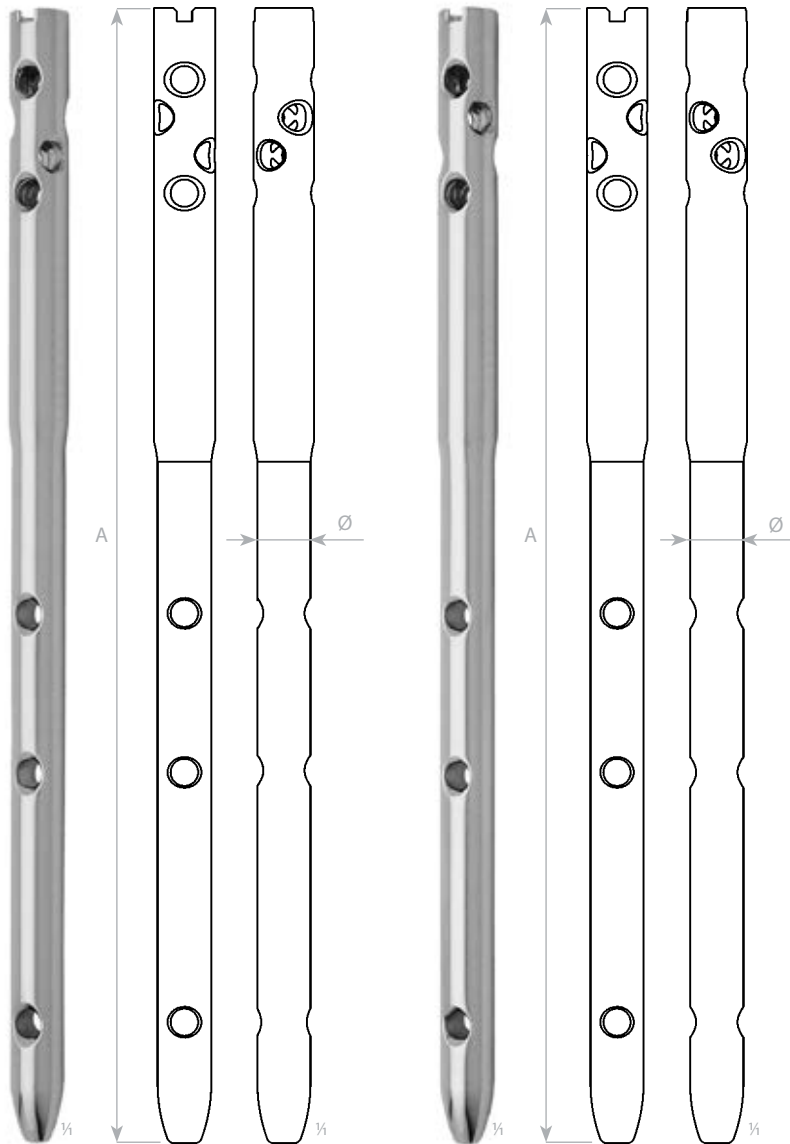

PRAVÝ
RIGHT

LEVÝ
LEFT

Hřeb humerální krátký, pravý
Short humeral nail, right

SSt	Ti	A	Ø
397 129 77 8680	397 129 77 8683	150 mm	7 mm
397 129 77 8690	397 129 77 8693	150 mm	8 mm
397 129 78 6050	397 129 78 6053	150 mm	9 mm

Hřeb humerální krátký, levý
Short humeral nail, left

SSt	Ti	A	Ø
397 129 77 9500	397 129 77 9503	150 mm	7 mm
397 129 77 9510	397 129 77 9513	150 mm	8 mm
397 129 78 6060	397 129 78 6063	150 mm	9 mm

HŘEBY HUMERÁLNÍ DLOUHÉ

LONG HUMERAL NAILS

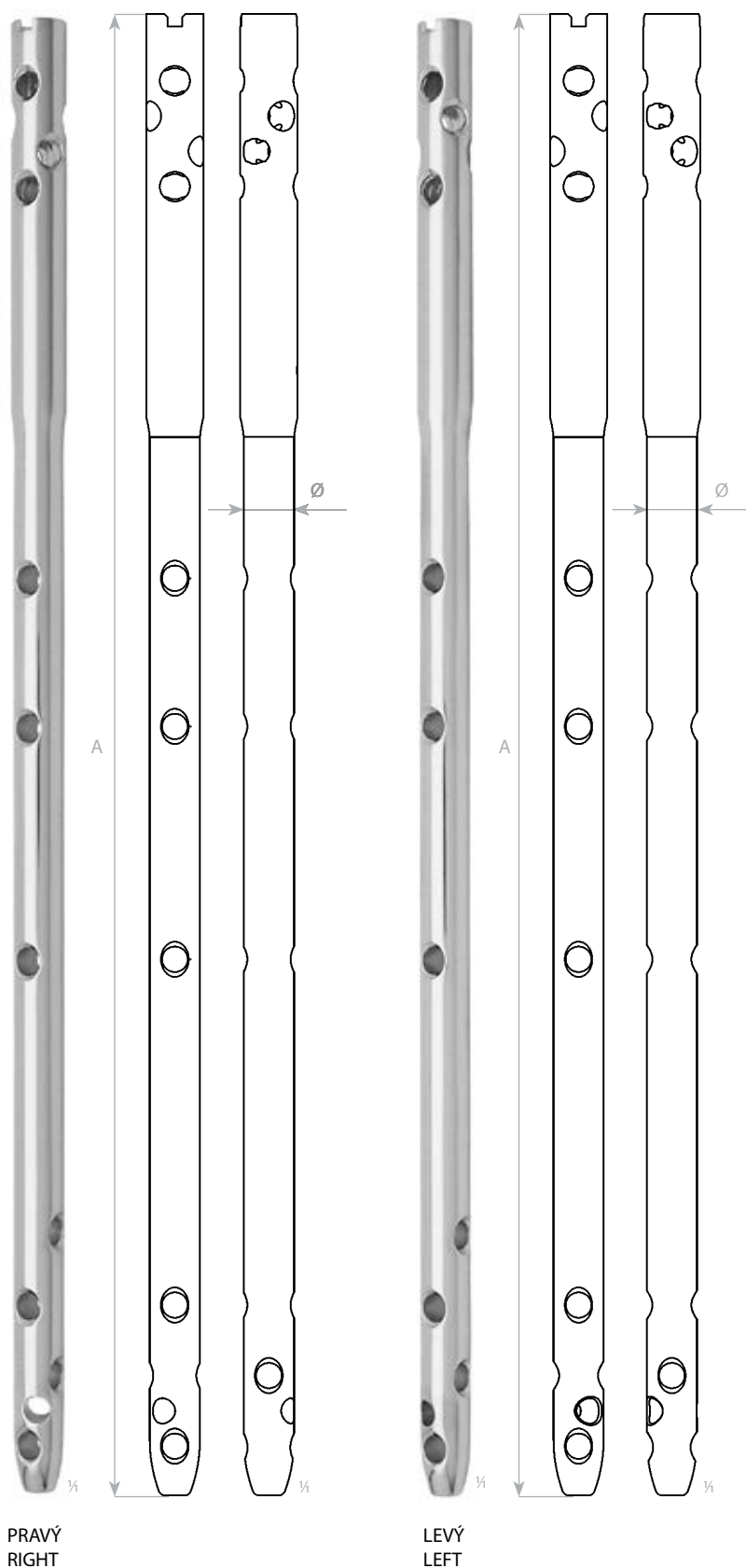

Hřeb humerální dlouhý, pravý

Long humeral nail, right

SSt	Ti	A	Ø
397 129 77 9640	397 129 77 9643	190 mm	7 mm
397 129 77 9650	397 129 77 9653	210 mm	7 mm
397 129 77 9660	397 129 77 9663	230 mm	7 mm
397 129 77 9670	397 129 77 9673	250 mm	7 mm
397 129 77 9680	397 129 77 9683	270 mm	7 mm
397 129 77 9690	397 129 77 9693	290 mm	7 mm

397 129 77 9760	397 129 77 9763	190 mm	8 mm
397 129 77 9770	397 129 77 9773	210 mm	8 mm
397 129 77 9780	397 129 77 9783	230 mm	8 mm
397 129 77 9790	397 129 77 9793	250 mm	8 mm
397 129 77 9800	397 129 77 9803	270 mm	8 mm
397 129 77 9810	397 129 77 9813	290 mm	8 mm

Hřeb humerální dlouhý, levý

Long humeral nail, left

SSt	Ti	A	Ø
397 129 77 9700	397 129 77 9703	190 mm	7 mm
397 129 77 9710	397 129 77 9713	210 mm	7 mm
397 129 77 9720	397 129 77 9723	230 mm	7 mm
397 129 77 9730	397 129 77 9733	250 mm	7 mm
397 129 77 9740	397 129 77 9743	270 mm	7 mm
397 129 77 9750	397 129 77 9753	290 mm	7 mm

397 129 77 9820	397 129 77 9823	190 mm	8 mm
397 129 77 9830	397 129 77 9833	210 mm	8 mm
397 129 77 9840	397 129 77 9843	230 mm	8 mm
397 129 77 9850	397 129 77 9853	250 mm	8 mm
397 129 77 9860	397 129 77 9863	270 mm	8 mm
397 129 77 9870	397 129 77 9873	290 mm	8 mm

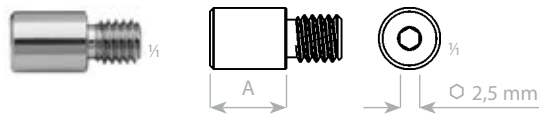
IMPLANTÁTY PRO HŘEBY HUMERÁLNÍ KRÁTKÉ A DLOUHÉ
 IMPLANTS FOR SHORT AND LONG HUMERAL NAILS

Zátka
 End cap

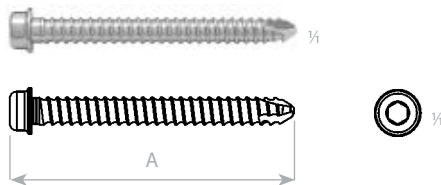
	SSt	Ti	A	
	397 129 77 2210	397 129 77 2213	0 mm	Fig. 0
	397 129 77 2220	397 129 77 2223	5 mm	Fig. 5
	397 129 77 2230	397 129 77 2233	10 mm	Fig. 10

Šroub zajišťovací zesílený s plochou hlavou 3,5 mm
 Locking screw strengthened with flanged head 3.5 mm

průměr závitu	thread diameter	3,5 mm
průměr jádra	core diameter	2,9 mm
průměr hlavy	head diameter	6,0 mm
vrták pro závit	drill bit for threaded hole	Ø 2,7/2,9 mm
šroubovák	screwdriver	Ø 2,5 mm

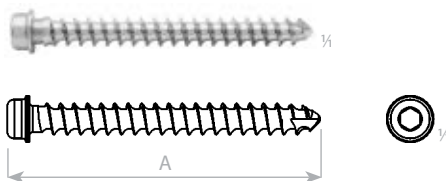
	SSt	Ti	A
	397 129 78 5841	397 129 78 5844	20 mm
	397 129 78 5851	397 129 78 5854	22 mm
	397 129 78 5861	397 129 78 5864	24 mm
	397 129 78 5871	397 129 78 5874	26 mm
	397 129 78 5881	397 129 78 5884	28 mm
	397 129 78 5891	397 129 78 5894	30 mm
	397 129 78 5901	397 129 78 5904	32 mm
	397 129 78 5911	397 129 78 5914	34 mm
	397 129 78 5921	397 129 78 5924	36 mm
	397 129 78 5931	397 129 78 5934	38 mm
	397 129 78 5941	397 129 78 5944	40 mm
	397 129 78 5951	397 129 78 5954	42 mm
	397 129 78 5961	397 129 78 5964	44 mm
	397 129 78 5971	397 129 78 5974	46 mm
	397 129 78 5981	397 129 78 5984	48 mm
	397 129 78 5991	397 129 78 5994	50 mm
	397 129 78 6001	397 129 78 6004	55 mm
	397 129 78 6011	397 129 78 6014	60 mm
	397 129 78 6021	397 129 78 6024	65 mm
	397 129 78 6031	397 129 78 6034	70 mm

Šroub zajišťovací s plochou hlavou 4,0 mm
 Locking screw with flanged head 4.0 mm

průměr závitu	thread diameter	3,5 mm
průměr jádra	core diameter	2,5 mm
průměr hlavy	head diameter	6,0 mm
vrták pro závit	drill bit for threaded hole	Ø 2,7/2,9 mm
šroubovák	screwdriver	Ø 2,5 mm

	SSt	Ti	A
	397 129 78 5371	397 129 78 5374	14 mm
	397 129 78 5381	397 129 78 5384	16 mm
	397 129 78 5391	397 129 78 5394	18 mm
	397 129 78 5401	397 129 78 5404	20 mm
	397 129 78 5411	397 129 78 5414	22 mm
	397 129 78 5421	397 129 78 5424	24 mm
	397 129 78 5431	397 129 78 5434	26 mm
	397 129 78 5441	397 129 78 5444	28 mm
	397 129 78 5451	397 129 78 5454	30 mm
	397 129 78 5461	397 129 78 5464	32 mm
	397 129 78 5471	397 129 78 5474	34 mm
	397 129 78 5481	397 129 78 5484	36 mm
	397 129 78 5491	397 129 78 5494	38 mm
	397 129 78 5501	397 129 78 5504	40 mm
	397 129 78 5511	397 129 78 5514	42 mm
	397 129 78 5521	397 129 78 5524	44 mm
	397 129 78 5531	397 129 78 5534	46 mm
	397 129 78 5541	397 129 78 5544	48 mm
	397 129 78 5551	397 129 78 5554	50 mm
	397 129 78 5561	397 129 78 5564	55 mm
	397 129 78 5571	397 129 78 5574	60 mm

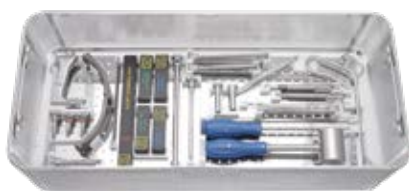
INSTRUMENTÁRIUM PRO HŘEBY HUMERÁLNÍ KRÁTKÉ A DLOUHÉ
INSTRUMENTS FOR SHORT AND LONG HUMERAL NAILS

397 139 09 0300 Set instrumentů pro hřeby humerální
540 × 240 × 130 mm
včetně nástrojů

Set of instruments for humeral nails
540 × 240 × 130 mm
including instruments



397 129 69 6015

soubor

set

1	397 129 69 6320	Cílič humerální krátký
2	397 129 69 6100	Týč dotahovací
3	397 129 09 9950	Drát s olivkou; 2,5×170 mm
4	397 129 69 6090	Pouzdro frézovací 9,2 mm
5	397 129 69 6280	Pouzdro 9/2,5×49 mm
6	397 129 79 9770	Fréza 8 mm
7	397 129 79 9775	Fréza 9 mm
8	397 129 69 6300	Důlčík 6 mm
9	397 129 69 6340	Pouzdro 8/6×110 mm
10	397 129 69 6350	Pouzdro 6/2,7×128 mm
11	397 129 69 6670	Pouzdro 6/2×128 mm
12	397 129 69 7960	Pouzdro 6/2,9×128 mm
13	397 129 69 6291	Vrták 2,7×230 mm
14	397 129 69 7971	Vrták 2,9×230 mm
15	397 129 78 9540	MÉDIN K-drát 2×230 mm; žlutý
16	397 129 69 8080	Hloubkoměr
17	397 129 69 8090	Měrka
18	397 129 69 5800	Šroubovák šestihran 2,5; 232 mm
19	397 129 69 6050	Osa kladiva
20	397 129 69 6060	Kladivo 400 g
21	397 129 69 1670	Perforátor 210 mm

		Short humeral aiming device
		Wrench rod
		Wire with olive; 2.5×170 mm
		Cutting sleeve 9.2 mm
		Delimitation sleeve 9/2.5×49 mm
		Cutter 8 mm
		Cutter 9 mm
		Trocar 6 mm
		Sleeve 8/6×110 mm
		Sleeve 6/2.7×128 mm
		Sleeve 6/2×128 mm
		Sleeve 6/2.9×128 mm
		Drill 2.7×230 mm
		Drill 2.9×230 mm
		MÉDIN K-wire 2×230 mm; yellow
		Depth gauge
		Gauge
		Screwdriver hexagonal; 2.5 mm; 232 mm
		Mallet axis
		Mallet 400 g
		Awl 210 mm

ks/pcs

1
1
1
1
1
1
1
1
2
2
2
2
2
2
2
1
1
1
1
1
1

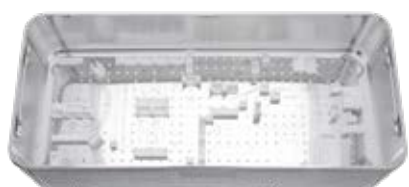

397 129 69 6010 Síto na instrumentárium pro hřeby humerální
540 × 240 × 130 mm
bez nástrojů

Sieve for instruments for humeral nails
540 × 240 × 130 mm
excluding instruments

INSTRUMENTÁRIUM PRO HŘEBY HUMERÁLNÍ KRÁTKÉ A DLOUHÉ
INSTRUMENTS FOR SHORT AND LONG HUMERAL NAILS



397 139 09 0630 Set instrumentů pro hřebý humerální
540 × 240 × 130 mm
včetně nástrojů

Set of instruments for humeral nails
540 × 240 × 130 mm
including instruments

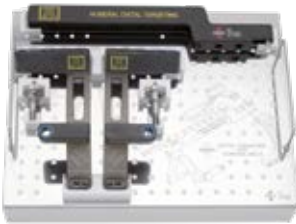

397 139 09 0620 Set instrumentů pro distální cílení humerus
včetně nástrojů

Set of instruments for distal humeral aiming
including instruments



397 129 69 6920 Cílič pro distální humerus

Aiming device for distal humerus

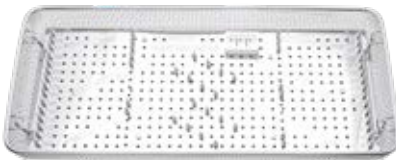

397 129 69 6020 Síto na hřebý humerální
540 × 240 × 50 mm
bez implantátů

Sieve for humeral nails
540 × 240 × 50 mm
excluding implants

Síto slouží pro uložení: hřebů humerálních krátkých pravých Ø 7; 8; 9 mm (3×1 ks), hřebů humerálních krátkých levých Ø 7; 8; 9 mm (3×1 ks), hřebů humerálních dlouhých pravých Ø 7; 8 mm (12×1 ks), hřebů humerálních dlouhých levých Ø 7; 8 mm (12×1 ks) a zátek (3×2 ks).

Sieve is for keeping of: right short humeral nails Ø 7; 8; 9 mm (3×1 piece), left short humeral nails Ø 7; 8; 9 mm (3×1 piece), right long humeral nails Ø 7; 8 mm (12×1 piece), right long humeral nails Ø 7; 8 mm (12×1 piece) and end caps (3×2 pcs).

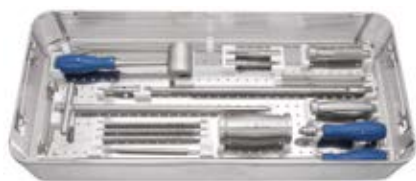
INSTRUMENTÁRIUM NA EXTRAKCI HŘEBŮ
INSTRUMENTS FOR NAIL EXTRACTION

397 139 09 0660 Set na extrakci hřebů
540 × 240 × 90 mm
včetně nástrojů

 Set for nail extraction
540 × 240 × 90 mm
including instruments
**397 129 69 7855**

soubor

set

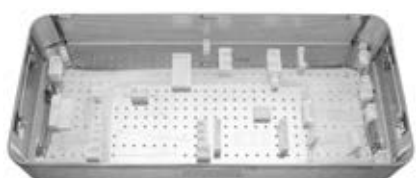
			ks/pcs
1	397 129 69 1590	Klíč	1
2	397 129 69 1610	Tyč vytahovací 350 mm	1
3	397 129 69 5131	Držadlo	1
4	397 129 69 5231	Šroubovák šestihran 2,5×160 mm	2
5	397 129 69 5251	Šroubovák šestihran 3,5×160 mm	2
6	397 129 69 5273	Šroubovák šestihran 5×160 mm	2
7	397 129 69 6050	Osa kladiva	1
8	397 129 69 6060	Kladivo 400 g	1
9	397 129 69 6100	Tyč dotahovací	2
10	397 129 69 7820	Přechodka M6_M8 mm	1
11	397 129 69 7830	Vytahovač M6_M8 mm	2
12	397 129 69 7840	Tyč vytloukáč	1
13	397 129 99 1012	Vytahovač zlomených hřebů	1
14	397 148 51 0100	Exkavátor oboustranný 1,5 mm; 17,0 cm	1
15	P3400351	Závaží 1000 g	1
16	P3403565	Držadlo	1

397 129 69 7850 Síto na instrumentárium na extrakci hřebů
540 × 240 × 90 mm
bez nástrojů

 Sieve for instruments for nail extraction
540 × 240 × 90 mm
excluding instruments

INSTRUMENTÁRIUM NA EXTRAKCI ŠROUBŮ
 INSTRUMENTS FOR SCREW EXTRACTION

397 139 09 0650 Set na extrakci šroubů
 540 × 240 × 50 mm
 včetně nástrojů

 Set for screw extraction
 540 × 240 × 50 mm
 including instruments

397 129 69 7795

soubor

set

ks/pcs

1	397 129 69 8260	Vrták 2,1×49 mm	Drill 2.1×49 mm	2
2	397 129 69 8270	Vrták 2,5×57 mm	Drill 2.5×57 mm	2
3	397 129 69 7740	Vrták 2,8×61 mm	Drill 2.8×61 mm	2
4	397 129 69 7750	Vrták 3,6×70 mm	Drill 3.6×70 mm	2
5	397 129 69 8290	Vrták 4,1×75 mm	Drill 4.1×75 mm	2
6	397 129 69 7770	Vrták 5,1×86 mm	Drill 5.1×86 mm	2
7	397 129 69 8220	Fréza válcová 2/2,4/2,7	Cylindrical cutter 2/2.4/2.7	1
8	397 129 79 4600	Fréza válcová 3,5/4	Cylindrical cutter 3.5/4	1
9	397 129 79 4610	Fréza válcová 4,5/5	Cylindrical cutter 4.5/5	1
10	397 129 79 4620	Fréza válcová 6,5/7	Cylindrical cutter 6.5/7	1
11	397 129 69 8230	Fréza 2/2,4/2,7	Cutter 2/2.4/2.7	1
12	397 129 79 4570	Fréza 3,5/4	Cutter 3.5/4	1
13	397 129 79 4580	Fréza 4,5/5	Cutter 4.5/5	1
14	397 129 79 4590	Fréza 6,5/7	Cutter 6.5/7	1
15	397 129 69 8210	Vytahovač 2/2,4/2,7	Extractor 2/2.4/2.7	1
16	397 129 79 4540	Vytahovač 3,5/4	Extractor 3.5/4	1
17	397 129 79 4550	Vytahovač 4,5/5	Extractor 4.5/5	1
18	397 129 79 4560	Vytahovač 6,5/7	Extractor 6.5/7	1

19	397 129 69 8181	Vytahovač 2	Extractor 2	2
20	397 129 69 7711	Vytahovač 2,5	Extractor 2.5	2
21	397 129 69 7721	Vytahovač 3,5	Extractor 3.5	2
22	397 129 69 7731	Vytahovač 5	Extractor 5	2
23	397 129 69 7910	Bit šestihran 2 mm	Bit, hexagon 2 mm	2
24	397 129 69 5231	Šroubovák šestihr. 2,5 mm	Screwdriver, hexagon 2.5 mm	2
25	397 129 69 5251	Šroubovák šestihr. 3,5 mm	Screwdriver, hexagon 3.5 mm	2
26	397 129 69 5273	Šroubovák šestihr. 5 mm	Screwdriver, hexagon 5 mm	2
27	397 128 09 0140	Dláto ortopedické žlábkové 6 mm; 23,5 cm	Orthopedic gouge 6 mm; 23.5 cm	1
28	397 148 51 0100	Exkavátor oboustranný	Excavator double-sided	1
29	397 129 69 7800	Vytahovač šroubů	Screw extractor	1
30	397 129 69 8350	Kleště na vyťahování šroubů	Forceps for removing screws	1
31	397 129 69 8360	Kleště na vyťahování šroubů 2/2,4/2,7 mm	Forceps for removing screws 2/2.4/2.7 mm	1
32	BD23-110-AO	Držadlo AO; 30×151 mm	Handle AO; 30×151 mm	1
33	BT19-095-AO	Držadlo T AO; 95×81 mm	T-handle AO; 95×81 mm	1

397 129 69 7790 Síto na instrumentárium na extrakci šroubů
 540 × 240 × 50 mm
 bez nástrojů

 Sieve for instruments for screw extraction
 540 × 240 × 50 mm
 excluding instruments

ŠROUBY SKLUZNÉ KOMPRESNÍ DYNAMIC HIP AND CONDYLAR SCREWS



F

ŠROUBY SKLUZNÉ KOMPRESNÍ DYNAMIC HIP AND CONDYLAR SCREWS



Šrouby skluzné kompresní

Šrouby skluzné na osteosyntézu

Dlahy kyčelní

Šrouby kostní kortikální

Instrumentárium pro skluzný kompresní šroub

Dynamic hip and condylar screws

Dynamic hip and condylar screws

Hip plates

Cortical bone screws

Instruments for dynamic hip/condylar screws

F.1

1

2

3

4-5

ŠROUBY SKLUZNÉ NA OSTEOSYNTÉZU
DYNAMIC HIP AND CONDYLAR SCREWS

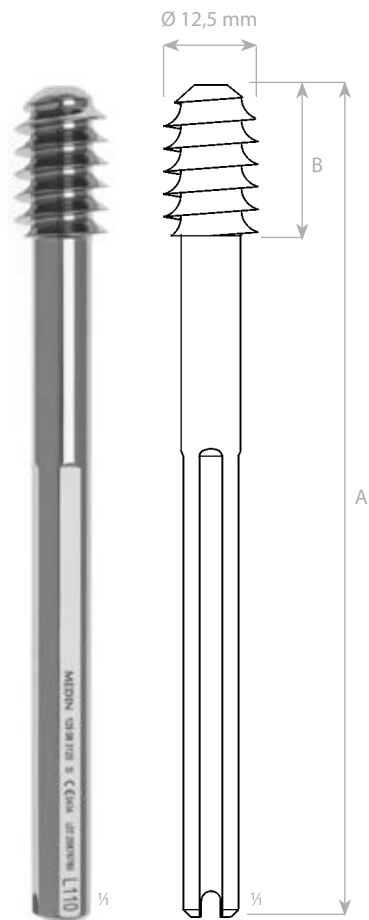

Šroub skluzný na osteosyntézu
Dynamic hip and condylar screw

SSt	A	B
397 129 08 3000	50 mm	20 mm
397 129 08 3010	55 mm	20 mm
397 129 08 3020	60 mm	20 mm
397 129 08 3030	65 mm	20 mm
397 129 08 3040	70 mm	20 mm
397 129 08 3050	75 mm	20 mm
397 129 08 3060	80 mm	20 mm
397 129 08 3070	85 mm	20 mm
397 129 08 3080	90 mm	20 mm
397 129 08 3090	95 mm	20 mm
397 129 08 3100	100 mm	20 mm
397 129 08 3110	105 mm	20 mm
397 129 08 3120	110 mm	20 mm
397 129 08 3130	115 mm	20 mm
397 129 08 3140	120 mm	20 mm
397 129 08 3400	50 mm	33 mm
397 129 08 3410	55 mm	33 mm
397 129 08 3420	60 mm	33 mm
397 129 08 3430	65 mm	33 mm
397 129 08 3440	70 mm	33 mm
397 129 08 3450	75 mm	33 mm
397 129 08 3460	80 mm	33 mm
397 129 08 3470	85 mm	33 mm
397 129 08 3480	90 mm	33 mm
397 129 08 3490	95 mm	33 mm
397 129 08 3500	100 mm	33 mm
397 129 08 3510	105 mm	33 mm
397 129 08 3520	110 mm	33 mm
397 129 08 3530	115 mm	33 mm
397 129 08 3540	120 mm	33 mm

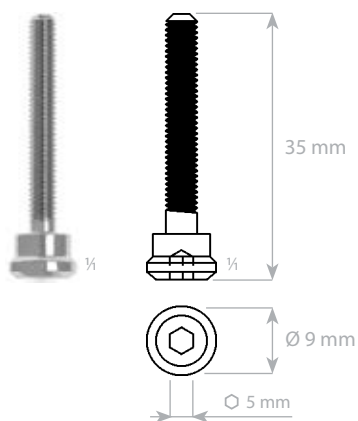

Šroub kompresní
Compression screw

SSt	A	M 4
397 129 09 1440	35 mm	

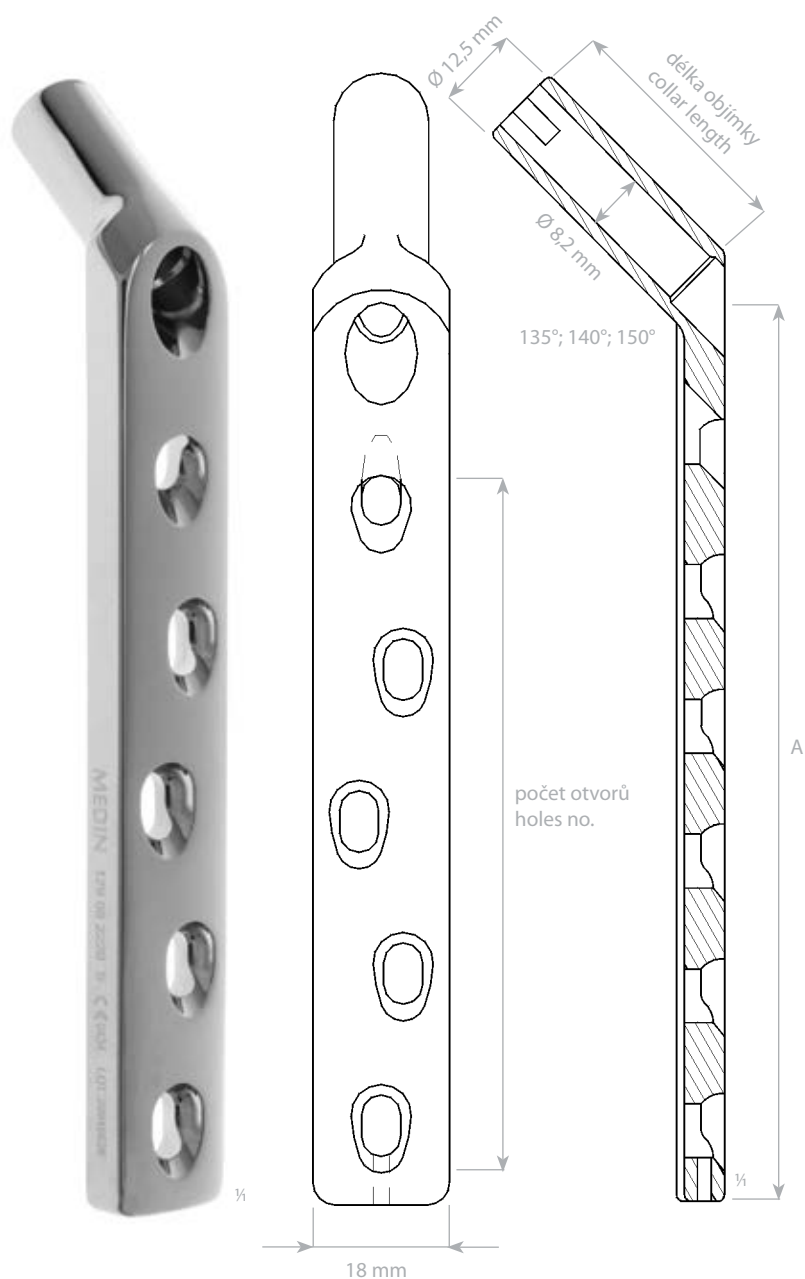
Dlaha kyčelní
Hip plate

SSt	135°	140°	150°	otvorů holes	objímka collar	A
397 129 08 2120	135°			2	1"	52 mm
397 129 08 2290	135°			3	1"	72 mm
397 129 08 2210	135°			4	1"	92 mm
397 129 08 2220	135°			5	1"	112 mm
397 129 08 2230	135°			6	1"	132 mm
397 129 08 2110	135°			2	1,5"	52 mm
397 129 08 2270	135°			3	1,5"	72 mm
397 129 08 2150	135°			4	1,5"	92 mm
397 129 08 2160	135°			5	1,5"	112 mm
397 129 08 2170	135°			6	1,5"	132 mm
397 129 08 2140	150°			2	1"	52 mm
397 129 08 2300	150°			3	1"	72 mm
397 129 08 2240	150°			4	1"	92 mm
397 129 08 2250	150°			5	1"	112 mm
397 129 08 2260	150°			6	1"	132 mm
397 129 08 2130	150°			2	1,5"	52 mm
397 129 08 2280	150°			3	1,5"	72 mm
397 129 08 2180	150°			4	1,5"	92 mm
397 129 08 2190	150°			5	1,5"	112 mm
397 129 08 2200	150°			6	1,5"	132 mm

 na zvláštní objednávku
 for special order

397 129 99 0208	135°	8	1,5"	172 mm
397 129 99 0166	135°	10	1,5"	212 mm
397 129 77 3810	140°	3	1,5"	72 mm
397 129 77 3820	140°	4	1,5"	92 mm
397 129 77 3830	140°	5	1,5"	112 mm
397 129 77 3840	140°	6	1,5"	132 mm
397 129 99 0264	150°	8	1,5"	172 mm
397 129 99 0348	150°	10	1,5"	212 mm

síla dlahy	plate thickness	6,0 mm
vzdálenost otvorů	distance of holes	20 mm

 ŠROUBY:
 kortikální šrouby HA 4,5

 SCREWS:
 cortical screws HA 4.5

ŠROUBY KOSTNÍ KORTIKÁLNÍ
CORTICAL BONE SCREWS

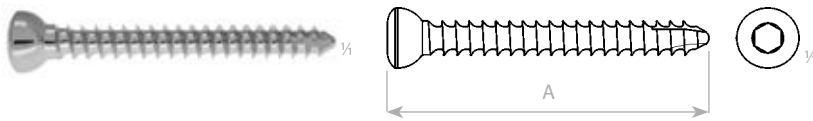

průměr závitu	thread diameter	4,5 mm
průměr jádra	core diameter	3,0 mm
průměr hlavy	head diameter	8,0 mm
vrták pro závit	drill bit for threaded hole	Ø 3,2 mm
vrták pro kluzný otvor	drill bit for gliding hole	Ø 4,5 mm
šroubovák	screwdriver	Ø 3,5 mm

Šroub kostní kortikální samořezný HA 4,5
Self-tapping cortical bone screw HA 4.5

SSt	A
397 129 79 9421	14 mm
397 129 79 9431	16 mm
397 129 79 9441	18 mm
397 129 79 5521	20 mm
397 129 79 9451	22 mm
397 129 79 9461	24 mm
397 129 79 5541	26 mm
397 129 79 9471	28 mm
397 129 79 5551	30 mm
397 129 79 9481	32 mm
397 129 79 9491	34 mm
397 129 79 5571	36 mm
397 129 79 9501	38 mm
397 129 79 5581	40 mm
397 129 79 9511	42 mm
397 129 79 9521	44 mm
397 129 79 9531	46 mm
397 129 79 9541	48 mm
397 129 79 5601	50 mm
397 129 79 9551	52 mm
397 129 79 9561	54 mm
397 129 79 9571	56 mm
397 129 79 9581	58 mm
397 129 79 5621	60 mm
397 129 79 5631	65 mm
397 129 79 5641	70 mm
397 129 79 5651	75 mm
397 129 79 5661	80 mm
397 129 79 5671	85 mm
397 129 79 5681	90 mm
397 129 79 5691	95 mm
397 129 79 5701	100 mm
397 129 79 5711	105 mm
397 129 79 5721	110 mm

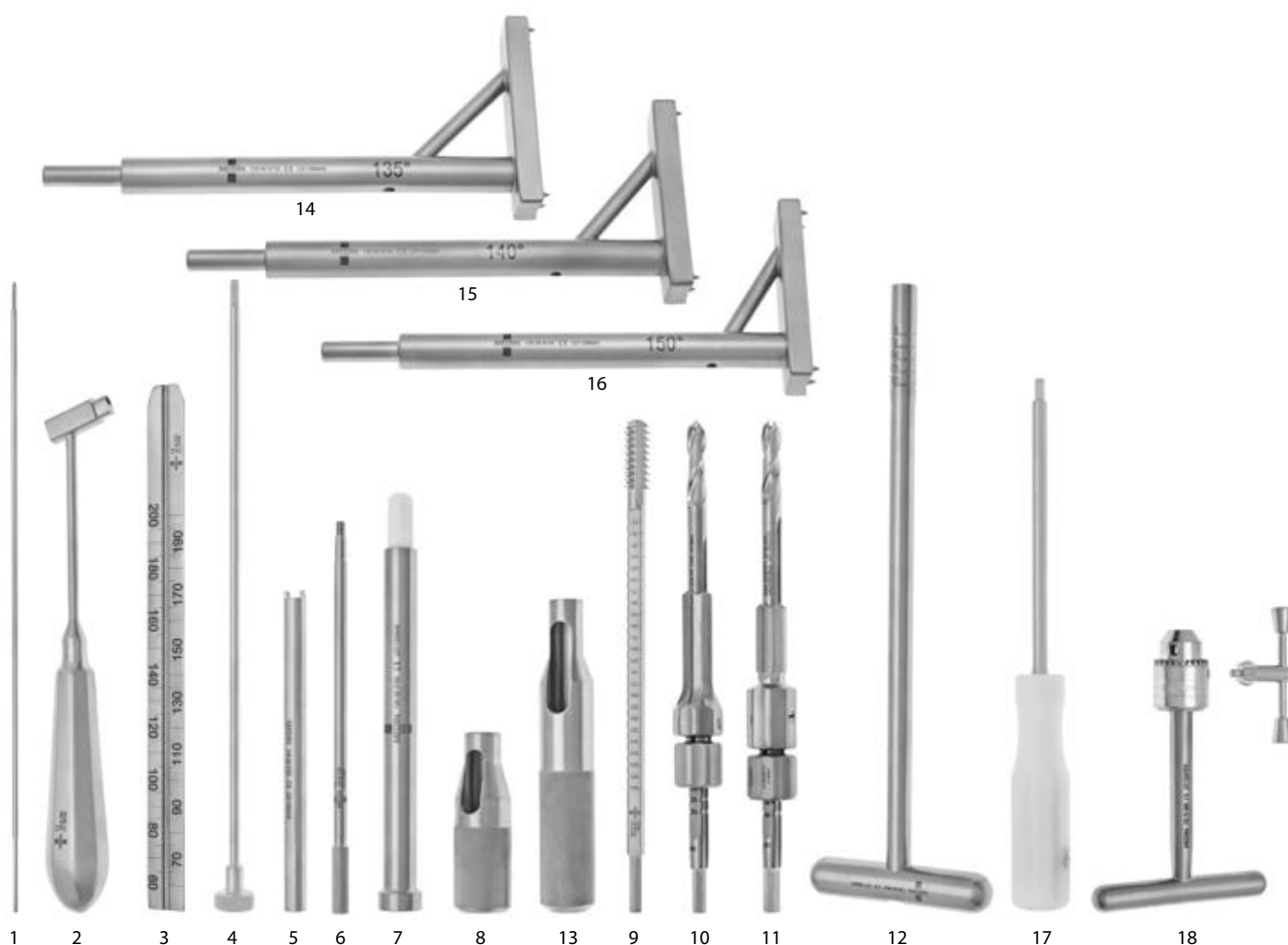
INSTRUMENTÁRIUM PRO SKLUZNÝ KOMPRESNÍ ŠROUB
INSTRUMENTS FOR DYNAMIC HIP/CONDYLAR SCREWS

397 139 09 0022

soubor

set

			ks/pcs	
1	397 129 08 3300	Vodící drát HA 2,5; 250 mm	Introducing wire with cortical thread 2.5; 250 mm	5
2	397 129 08 3680	Vrtací pouzdro; 184 mm	Drill sleeve; 184 mm	1
3	397 129 08 3700	Měřítka; 200 mm	Rule; 200 mm	1
4	397 129 08 3710	Šroub na vyjímání skluzných šroubů; 244 mm	Screw for extraction; 244 mm	1
5	397 129 08 3720	Zaváděcí stopka; průměr 5 mm; 112 mm	Guide shaft; diameter 5 mm; 112 mm	2
6	397 129 08 3730	Spojovací šroub; M 4; 137 mm	Connection screw; M 4; 137 mm	3
7	397 129 08 3740	Narážecí; 145 mm	Impactor; 145 mm	1
8	397 129 08 3760	Středící pouzdro; 60 mm	Centering sleeve; 60 mm	1
9	397 129 08 3771	Závitník na osteosyntézu; průměr 12,5 mm	Tap; diameter 12.5 mm	1
10	397 129 08 3800	Vrtací přípravek pro kyčel	Drill tip for hip	1
11	397 129 08 3790	Vrtací přípravek pro koleno	Drill tip for knee	1
12	397 129 08 3820	Klíč na osteosyntézu; průměr 10,5 mm; 245 mm	Intermediate T-wrench; diameter 10.5 mm; 245 mm	1
13	397 129 08 3830	Vodící pouzdro; 110 mm	Guide sleeve; 110 mm	1
14	397 129 08 8110	Cílič pro kyčel 135°; 162 mm	Hip aiming device 135°; 162 mm	1
15	397 129 08 8130	Cílič pro kyčel 140°; 161 mm	Hip aiming device 140°; 161 mm	1
16	397 129 08 8120	Cílič pro kyčel 150°; 162 mm	Hip aiming device 150°; 162 mm	1
17	397 129 79 3900	Šroubovák 3,5; 214 mm	Hexagon screwdriver 3.5; 214 mm	1
18	397 129 79 3990	Ruční sklíčidlo; 116 mm	Hand chuck; 116 mm	1

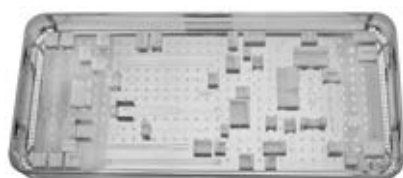

397 129 79 9610 Síto na instrumentárium pro skluzné kompresní šrouby
540 × 240 × 50 mm
síto bez nástrojů

Sieve for instruments for dynamic hip and condylar screws
540 × 240 × 50 mm
sieve excluding instruments

INSTRUMENTÁRIUM PRO SKLUZNÝ KOMPRESNÍ ŠROUB
 INSTRUMENTS FOR DYNAMIC HIP/CONDYLAR SCREWS

Doplňkové nástroje
 Supplementary instruments

- | | | | |
|---|------------------------|--|---|
| 1 | 397 129 08 3780 | Vrták pro kyčel Ø 8/2,7 mm; 200 mm | Drill tip for hip Ø 8/2.7 mm; 200 mm |
| 2 | 397 129 08 3690 | Vrták pro koleno Ø 8/2,7 mm; 200 mm | Drill tip for knee Ø 8/2.7 mm; 200 mm |
| 3 | 397 129 08 3270 | Vložka naražeče; 25 mm | Insert for impactor; 25 mm |
| 4 | 397 129 79 8970 | Pouzdro vrtací; průměr 3,7 mm; 20 mm | Drill sleeve; diameter 3.7 mm; 20 mm |
| 5 | 397 129 79 8581 | Vrták; průměr 3,2 mm; 210 mm, koncovka s ploškou | Drill; diameter 3.2 mm; 210 mm, flat connection |
| 6 | 397 129 79 8582 | Vrták; průměr 3,2 mm; 210 mm, koncovka tříhran | Drill; diameter 3.2 mm; 210 mm, triangular connection |

NÁSTROJE PRO TRAUMATOLOGII
INSTRUMENTS FOR TRAUMATOLOGY



Nástroje pro traumatologii

Kleště štípací
Kleště štípací na drát
Kleště na vytažení hřebu
Kleště úchopné na drát
Kleště na držení kostí
Kleště repositionální
Dláta
Kladivo chirurgické
Zatloukače, doražeče
Nástroj na protahování štěpů
Šídla kostní
Perforátory

Instruments for Traumatology

Bone rongeurs 1–3
Wire cutting forceps 4–5
Nail extraction forceps 6
Wire grasping forceps 6
Bone holding forceps 7
Reposition forceps 8–9
Gouges, chisels, osteotomes 10–13
Surgical mallet 13
Punches 14
Bone graft extractor 14
Bone awls 15
Perforators 15

G.1

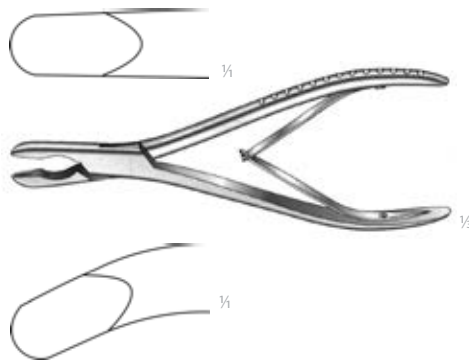

LUER
397 116 08 0030 rovné straight 8 mm 17,0 cm

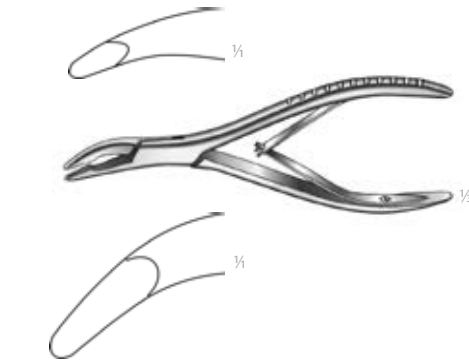

LUER
397 116 08 0080 zahnuté curved 3 mm 15,0 cm

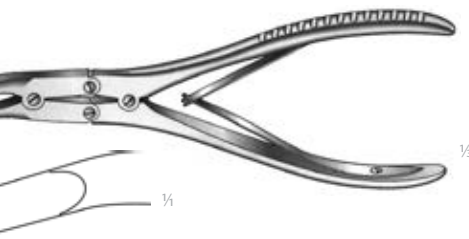

LUER
397 116 08 0070 zahnuté curved 4 mm 15,0 cm

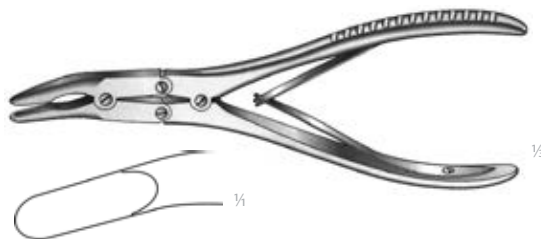

RUSKIN
397 116 08 0090 zahnuté curved 6 mm 20,0 cm

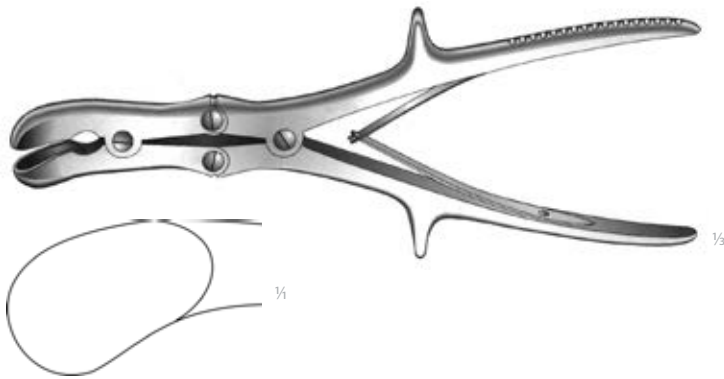

LUER
397 116 08 0130 lomené angled 4 mm 24,0 cm

KLEŠTĚ ŠTÍPACÍ
BONE RONGEURS

LUER
397 116 08 0140 zahnuté curved 17 mm 27,0 cm

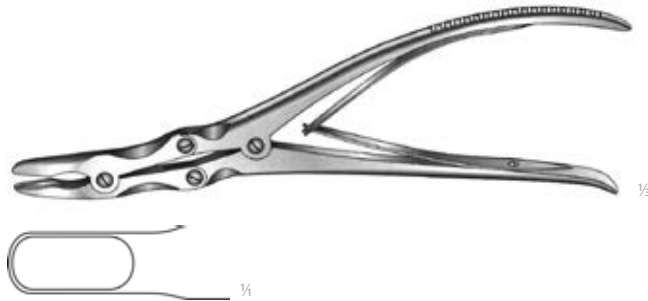

LUER
397 116 08 0150 rovné straight 7x16 mm 24,0 cm

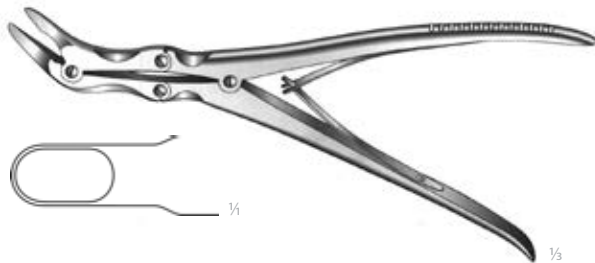

LUER
397 116 08 0160 lomené angled 7x13 mm 23,0 cm

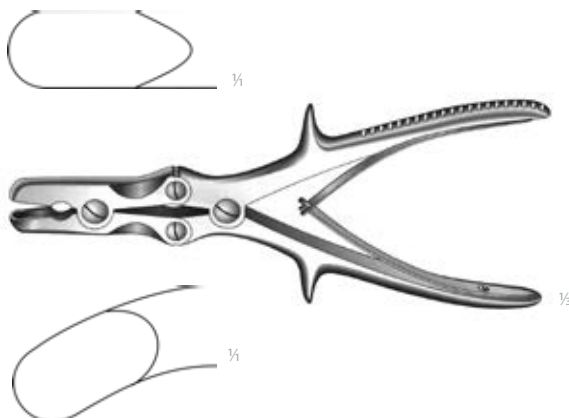

LUER
397 116 08 0180 rovné straight 10 mm 22,0 cm

LUER-STILLE
397 116 08 0190 lomené angled 10 mm 22,0 cm



LISTON

397 116 08 0410 rovné straight 14,0 cm

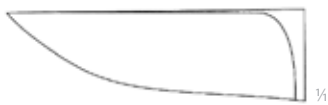

LISTON

397 116 08 0440 rovné straight 19,0 cm



LISTON

397 116 08 0450 zahnuté curved 19,0 cm

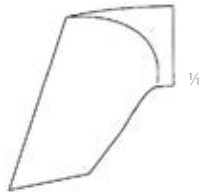
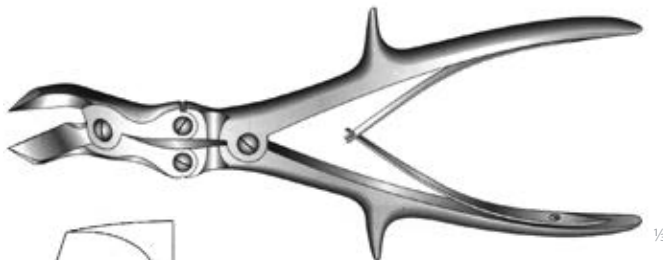

LISTON

397 116 08 0470 dvojitě zahnuté double curved 27,0 cm

KLEŠTĚ ŠTÍPACÍ NA DRÁT
WIRE CUTTING FORCEPS

397 116 91 0001 14,5 cm
pro měkký drát do \varnothing 1,5 mm
pro tvrdý drát do \varnothing 1,0 mm
for soft wires up to \varnothing 1,5 mm
for hard wires up to \varnothing 1,0 mm



397 116 91 0004 18,0 cm
pro měkký drát do \varnothing 2,0 mm
for soft wires up to \varnothing 2,0 mm



397 116 91 0005 17,0 cm
pro tvrdý drát do \varnothing 1,5 mm
for hard wires up to \varnothing 1,5 mm

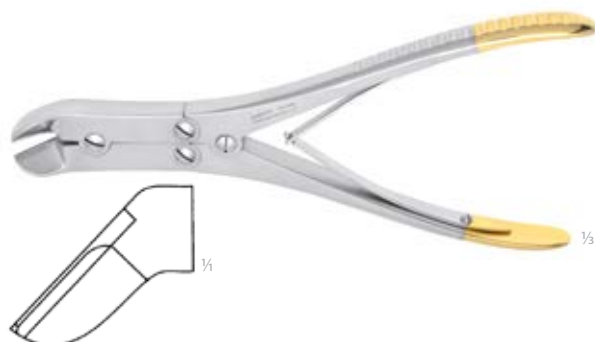

397 116 91 0006 22,0 cm
pro drát do \varnothing 2,5 mm
for wires up to \varnothing 2,5 mm



397 116 91 0010 21,5 cm
pro tvrdý drát do \varnothing 2,5 mm
for hard wires up to \varnothing 2,5 mm



397 116 91 0011 23,0 cm
pro tvrdý drát do \varnothing 2,2 mm
for hard wires up to \varnothing 2,2 mm

KLEŠTĚ ŠTÍPACÍ NA DRÁT
WIRE CUTTING FORCEPS



397 116 91 0007 47,0 cm
pro dráty, šrouby a hřebíky do průměru 6,0 mm
for wires, screws and nails up to diameter 6,0 mm



HERCULES
397 116 91 0008 28,0 cm
pro drát do průměru 4,0 mm
for wires up to diameter 4,0 mm



HERCULES
397 116 91 0539 23,0 cm
pro drát do průměru 3,0 mm
for wires up to diameter 3,0 mm



Sada gumových čelistí pro 116 91 0008, 0539
Set of rubber jaws for 116 91 0008, 0539

397 116 91 0540



Sada čelistí pro štípací kleště 116 91 0008
Set of jaws for wire forceps 116 91 0008

397 116 91 0009

Sada čelistí pro štípací kleště 116 91 0539
Set of jaws for wire forceps 116 91 0539

397 116 91 0541

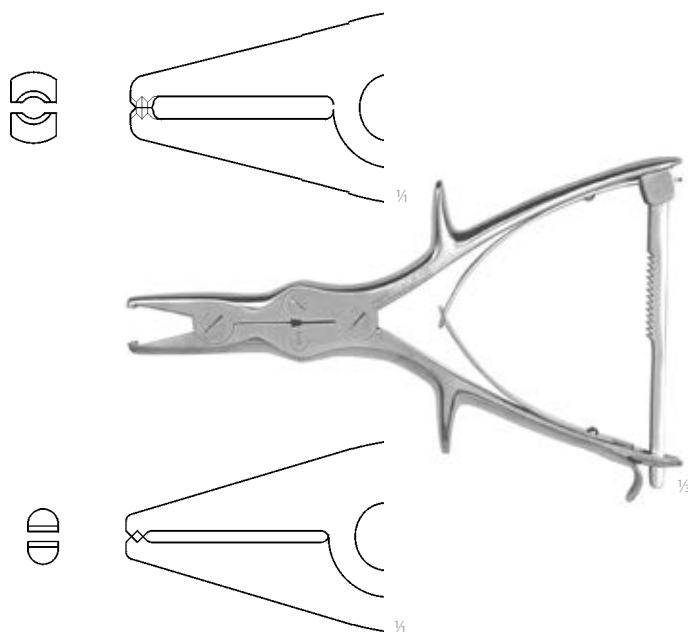
KLEŠTĚ NA VYTAŽENÍ HŘEBU
 NAIL EXTRACTION FORCEPS

BARTL
397 117 09 0260 21,5 cm
 na pruty od $\varnothing 2,0$ mm
 for nails up from $\varnothing 2,0$ mm

BARTL
397 117 09 0270 21,5 cm
 na pruty do $\varnothing 2,0$ mm
 for nails up to $\varnothing 2,0$ mm

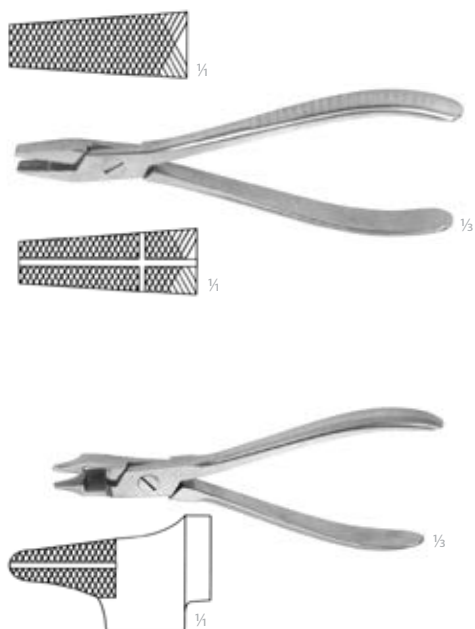
KLEŠTĚ ÚCHOPNÉ NA DRÁT
 WIRE GRASPING FORCEPS

397 117 91 0080 17,0 cm

397 117 91 0081 17,0 cm

397 117 91 0082 15,0 cm

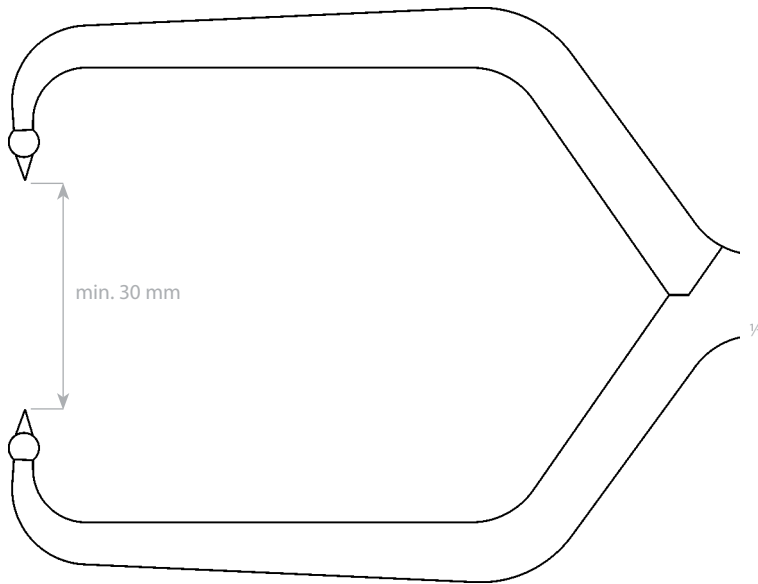

397 117 99 0039 23,5 cm
s kuličkou Ø 4 mm
with ball Ø 4 mm

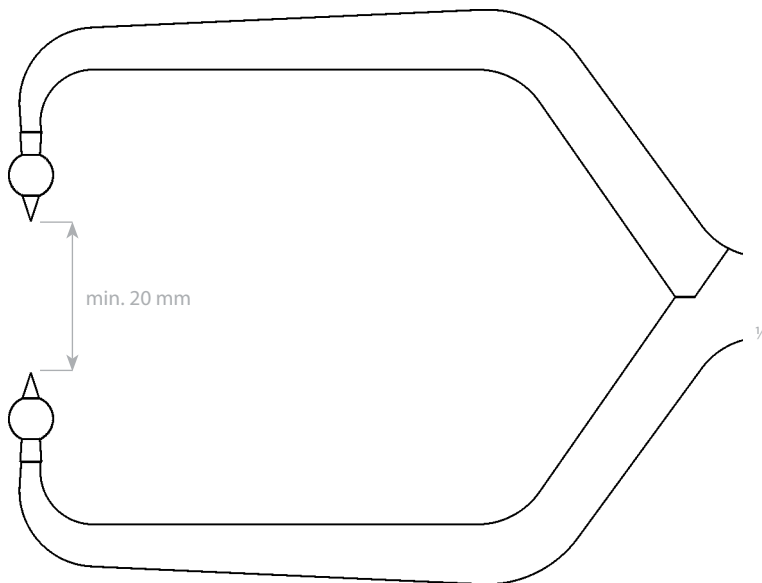

397 117 99 0044 23,5 cm
s kuličkou Ø 6 mm
with ball Ø 6 mm

397 117 99 0041 25,0 cm

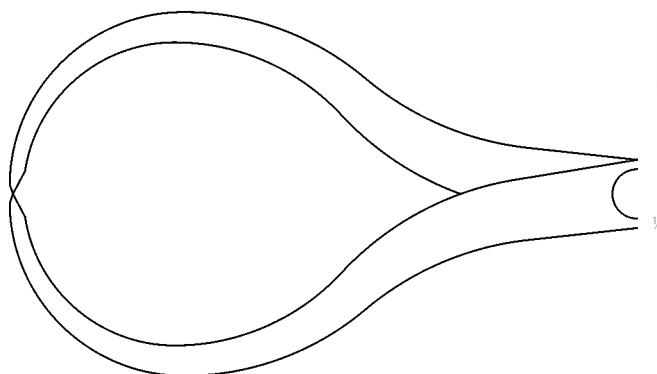

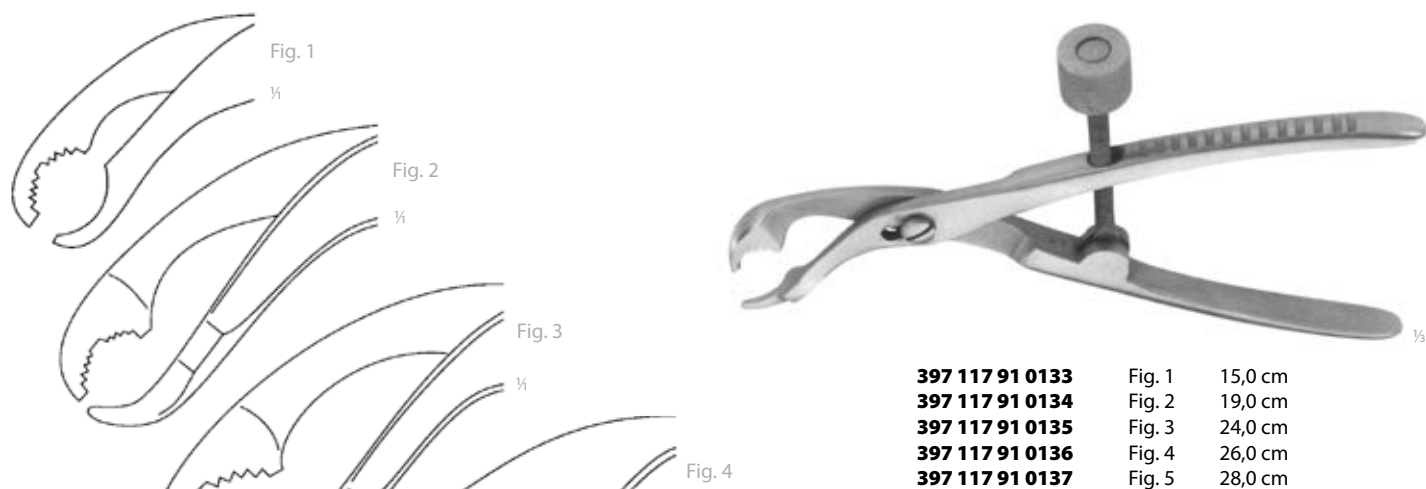
KLEŠTĚ REPOZIČNÍ
REPOSITION FORCEPS

397 117 91 0133	Fig. 1	15,0 cm
397 117 91 0134	Fig. 2	19,0 cm
397 117 91 0135	Fig. 3	24,0 cm
397 117 91 0136	Fig. 4	26,0 cm
397 117 91 0137	Fig. 5	28,0 cm

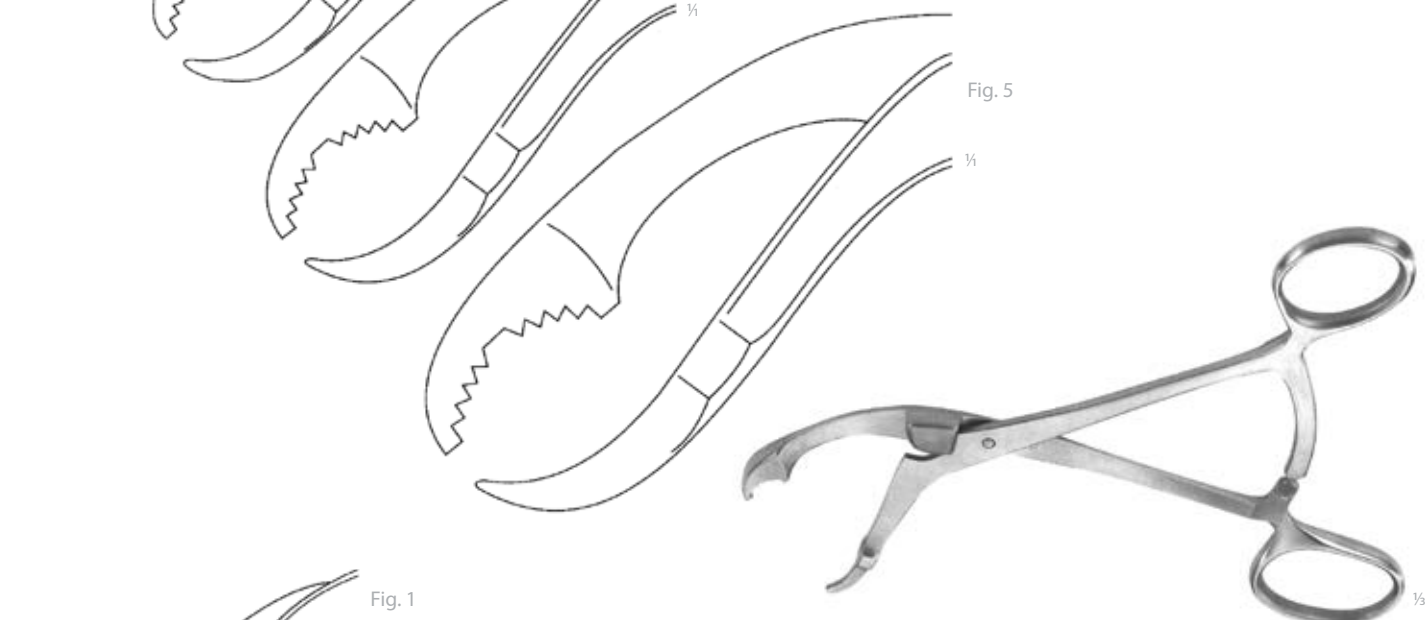

VERBRUGGE			
397 117 91 0120	5,0 mm	Fig. 1	17,5 cm
397 117 91 0121	9,5 mm	Fig. 2	25,0 cm
397 117 91 0122	10,5 mm	Fig. 3	26,0 cm
397 117 91 0123	12,0 mm	Fig. 4	27,0 cm

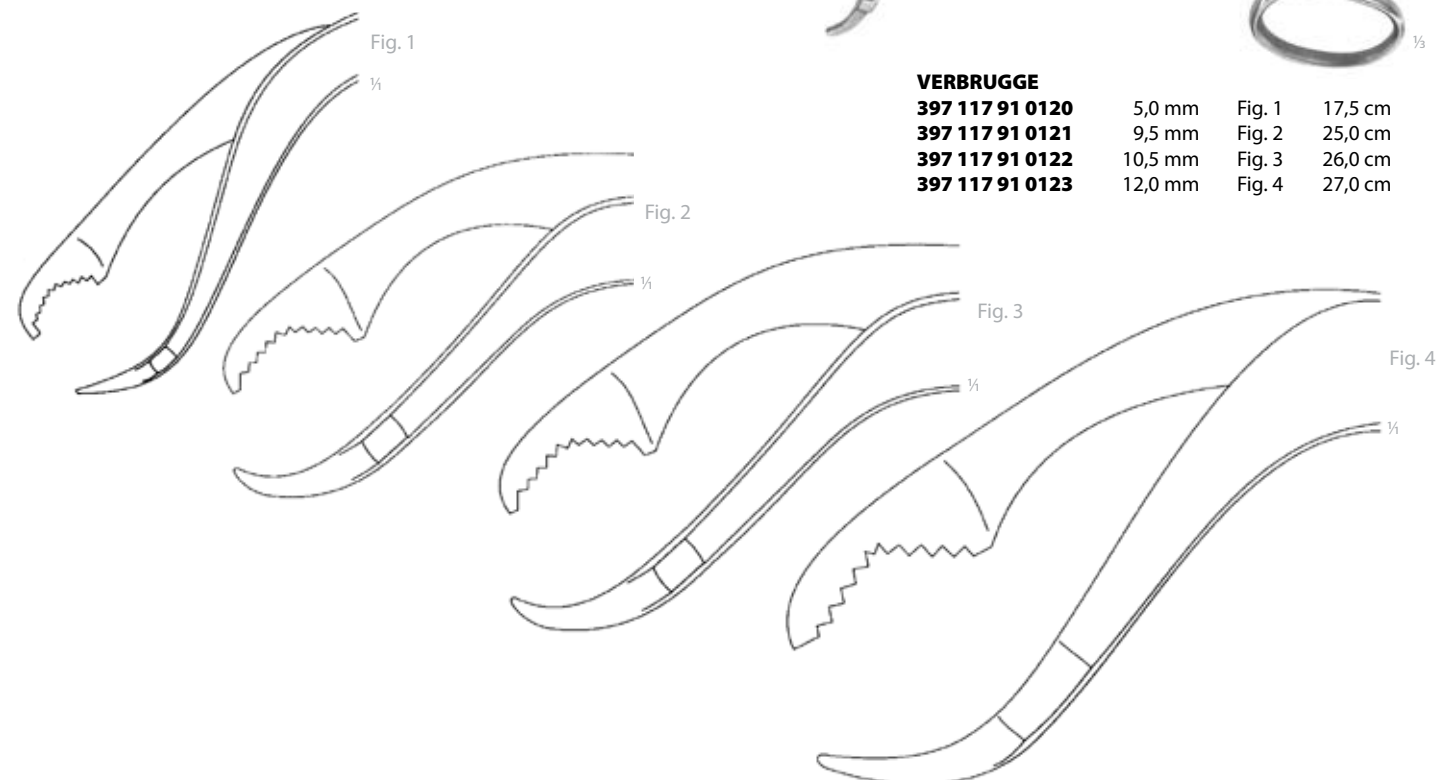



FARABEU-F-LAMBOTTE

397 117 91 0117 11,0 mm 26,0 cm

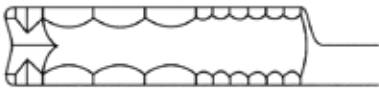

FARABEU-F

397 117 91 0118 9,0 mm 23,0 cm

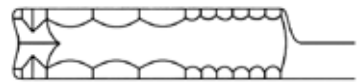
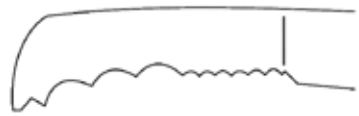
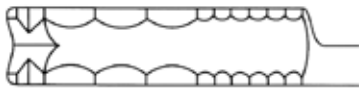
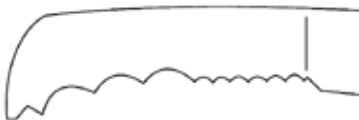

FARABEU-F

397 117 91 0119 11,0 mm 26,0 cm

DLÁTA
 GOUGES, CHISELS, OSTEOTOMES

Dláto žlábkové; obloukové
 Gouge bow-shaped

397 128 08 0250	10,0 mm	20,5 cm
397 128 08 0260	15,0 mm	20,5 cm
397 128 08 0270	20,0 mm	20,5 cm
397 128 08 0280	25,0 mm	20,5 cm
397 128 08 0290	30,0 mm	20,5 cm

Dláto žlábkové; rovné
 Gouge; straight

397 128 08 0300	10,0 mm	20,5 cm
397 128 08 0310	15,0 mm	20,5 cm
397 128 08 0320	20,0 mm	20,5 cm
397 128 08 0330	25,0 mm	20,5 cm
397 128 08 0340	30,0 mm	20,5 cm
397 128 08 0350	35,0 mm	20,5 cm

STILLE
Dláto poloklínové
 Chisel wedget

397 128 08 0160	15,0 mm	20,5 cm
------------------------	---------	---------

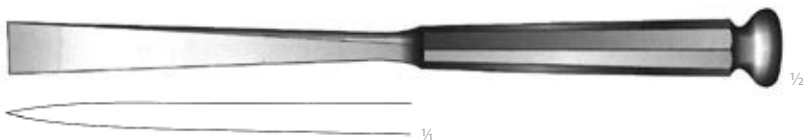
STILLE
Dláto ploché
 Osteotome

397 128 08 1050	6,0 mm	20,5 cm
397 128 08 1060	8,0 mm	20,5 cm
397 128 08 0010	10,0 mm	20,5 cm
397 128 08 0020	12,0 mm	20,5 cm
397 128 08 0030	15,0 mm	20,5 cm
397 128 08 0040	20,0 mm	20,5 cm
397 128 08 0050	25,0 mm	20,5 cm



1/2

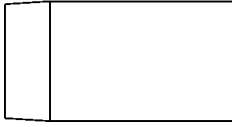
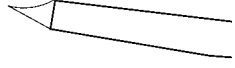

1/4

Dláto
Gouge

397 128 09 0200 16,0 × 4,0 mm 25,0 cm
žlábkové
grooved



1/2

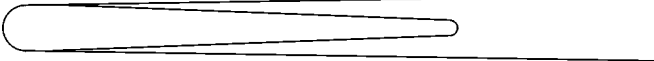
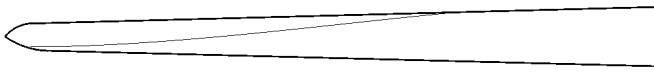

1/4

Dláto ortopedické
Osteotome

397 128 09 0140 6,0 mm 23,5 cm
žlábkové
gouge



1/2

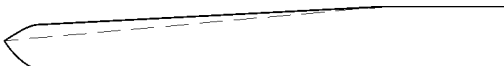

1/4

397 128 09 0150 7,0 mm 22,5 cm
žlábkové
gouge

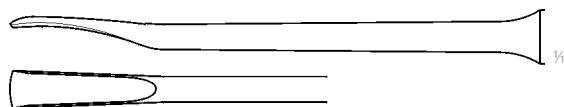
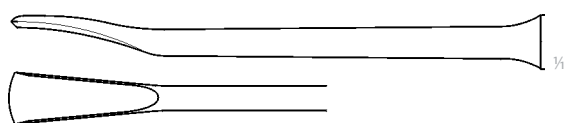
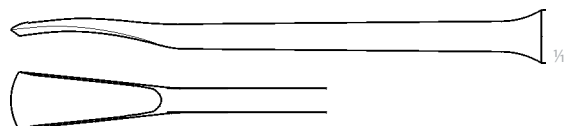
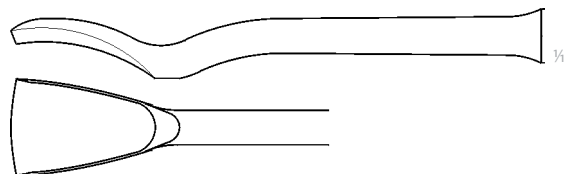
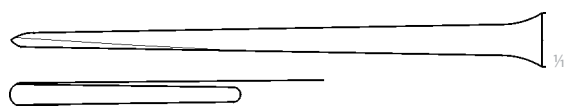
Dláto ortopedické
Osteotome

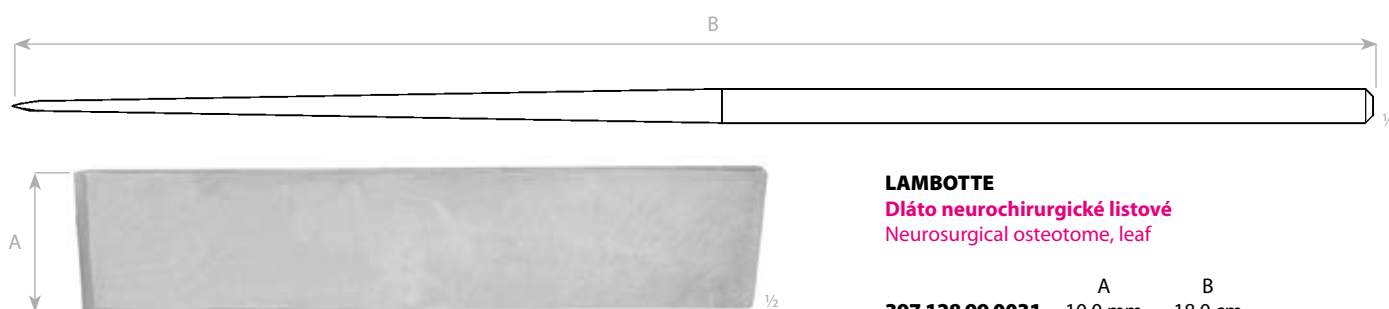
397 129 08 4910 9,0 mm 30,0 cm

397 129 08 4920 13,5 mm 30,0 cm

397 129 08 4930 15,3 mm 30,0 cm

397 129 08 4940 25,0 mm 30,0 cm

397 129 08 4950 6,0 mm 30,0 cm



LAMBOTTE
Dláto neurochirurgické listové
Neurosurgical osteotome, leaf

	A	B
397 128 99 0031	10,0 mm	18,0 cm
397 128 99 0032	15,0 mm	18,0 cm
397 128 99 0033	20,0 mm	18,0 cm
397 128 99 0035	25,0 mm	18,0 cm
397 128 99 0036	30,0 mm	18,0 cm
397 128 99 0038	40,0 mm	18,0 cm

KLADIVO CHIRURGICKÉ
SURGICAL MALLET



Kladivo chirurgické
Surgical mallet

397 128 08 0921 700 g 23,5 cm

ZATLOUKAČE, DORAŽEČE
PUNCHES

Naražec kostních štěpů
 Bone graft driver

397 128 09 0030 Ø 8 mm 26,0 cm

Naražec kostních štěpů
 Bone graft driver

397 128 09 0040 Ø 9 mm 21,0 cm

Tlouk
 Punch

397 128 99 0001 8 x 8 mm 22,5 cm

Zatloukač
 Punch

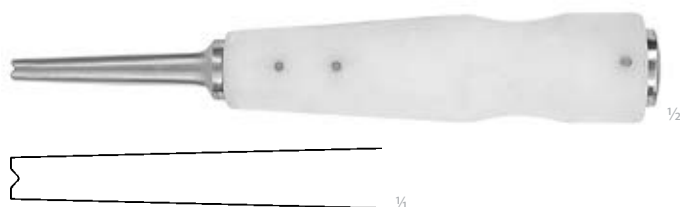
397 128 99 0015 Ø 3 mm 21,0 cm

Doražec extenčních drátů
 Extension wires punch

397 129 78 1000 17,0 cm

NÁSTROJ NA PROTAHOVÁNÍ ŠTĚPŮ
BONE GRAFT EXTRACTOR

Nástroj na protahování štěpů
 Bone graft extractor

397 129 08 3280 31,5 cm

ŠÍDLA KOSTNÍ
BONE AWLS

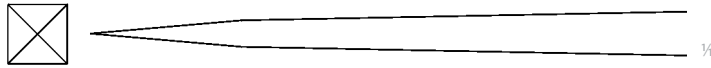

Šídlo kostní
Bone awl

397 129 09 0620 23,5 cm

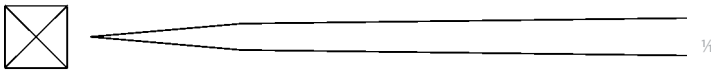

397 129 09 0630 30,0 cm

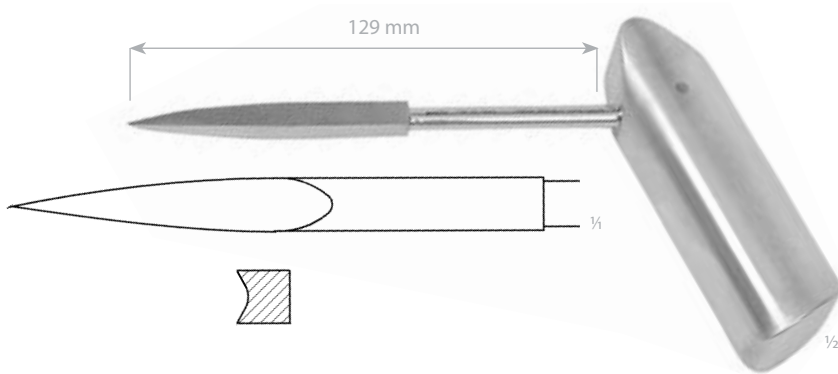

Šídlo kostní
Bone awl

397 129 09 0640 7 × 7 mm

PERFORÁTORY
PERFORATORS

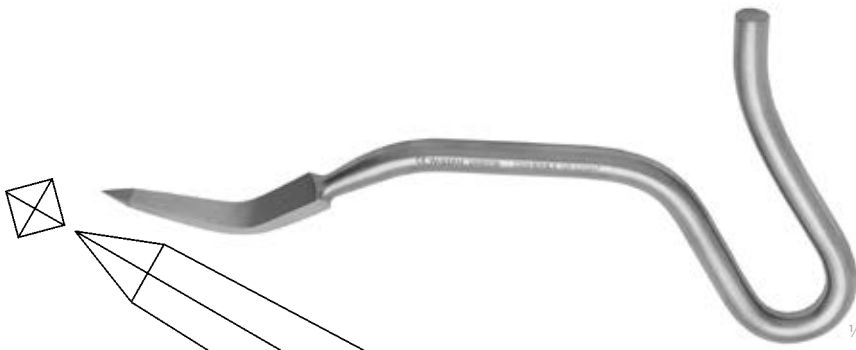

Perforátor
Perforator







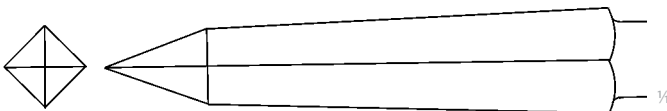
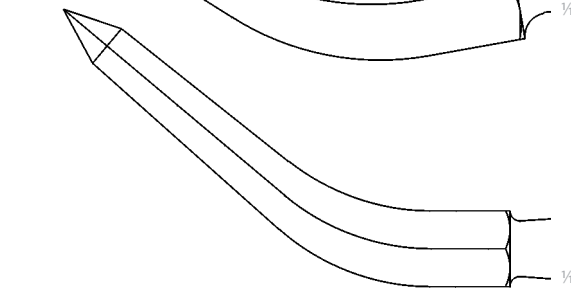















397 129 09 0700 12 × 12 mm 19,5 cm
zahnutý
curved



397 129 09 0710 10 × 10 mm 19,5 cm
zahnutý
curved



397 129 09 5920 12 × 12 mm 25,4 cm
rovný
straight

	použit do	use by
	datum výroby	date of manufacture
	výrobce	manufacturer
	nepoužívat opětovně	do not reuse
	neprovádět opětovnou sterilizaci	do not resterilize
	nepoužívat, jestliže je balení poškozeno	do not use if package is damaged
	otevřené balení nebude nahrazeno	opened packages are not replaced
	set, souprava	assortment
	seznamte se s návodem k použití	consult instructions for use
	seznamte se s návodem k použití kvůli důležitým varovným informacím	caution, consult accompanying documents
	nesterilní	non sterile
 xxx-xxx min ⁻¹	doporučené otáčky za minutu, doporučená frekvence otáčení	recommended rotation speed
	kód dávky	batch code
	katalogové číslo	catalogue number
	množství	quantity
	označuje kontrolní materiál	control
	sterilní	sterile
	sterilizováno ozářením	sterilization using irradiation
	sterilizováno ethylenoxidem	sterilization using ethylene oxide
	sterilizováno aseptickou technologií	sterile by aseptic techniques
	diagnostický zdravotnický prostředek in vitro	in vitro diagnostic medical device
	globální nomenklatura zdravotnických prostředků	global medical device nomenclature code



MEDIN, a.s.
Vlachovická 619
Nové Město na Moravě
CZ 592 31
Czech Republic
IČ 43378030
DIČ CZ43378030

www.medin.cz
www.medin.eu

PRODEJ ČESKÁ REPUBLIKA
tel.: 566 684 327
fax: 566 684 384
e-mail: prodej@medin.cz

EXPORT
phone: +420 566 684 371
fax: +420 566 684 385
e-mail: export@medin.cz



2018-10A